

2020

Catálogo Quick Coupling



La Conexión Correcta^{MR}



Soluciones. Servicio. Selección.

800.00.DIXON(34966) | dixonvalve.com.mx

Guía de Selección de Coples Rápidos Dixon

1. Determina el perfil (forma) del niple. Compara la forma del niple con la tabla de perfiles debajo para identificar la serie del cople rápido.



2. Las tablas con dimensiones de cuerpo pueden encontrarse en cada serie. Mide de A (diámetro) y B (punta) para determinar la medida del niple (fig.1).

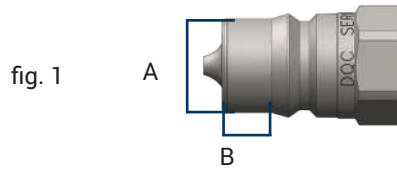

3. Utiliza la tabla debajo (o el diagrama 6) para determinar la medida de la conexión de extremo. Si tienes una barba para manguera, el DI de la manguera determina el tamaño de la barba (fig.2)

Rosca DE o DI	3/8"	1/2"	5/8"	3/4"	1"	1-3/8"	1-5/8"	1-29/32"	2-3/8"
Medida Rosca Nominal	1/8"	1/4"	3/8"	1/2"	3/4"	1"	1-1/4"	1-1/2"	2"



Perfil Neumático		Serie-DF acero • latón • Al 303	Serie-J acero • latón	Serie-M acero • latón
		Intercambio Industrial página 20	Automotriz página 30	ARO 210-310 página 35
Serie-CJ acero • latón	Serie-SHD acero • aluminum	Serie-L acero • latón	Serie-U latón	Serie-N acero • latón • Al 303 • Al 316
Alto Flujo página 39	Twist-Lock página 42	Lincoln página 45	Aire Universal página 47	Bowes / Dix-Lock® página 49
Serie-P acero • latón • Al 303	Serie-NK acero	Serie-BR latón	Serie-A acero • latón	Serie-SCV latón
Thor / Dual-Lock página 57	Industrial Japonés página 61	Serie 21 página 63	Compacto página 65	Válvula Check Seguridad página 68

























Perfil Hidráulico	Serie-H acero • latón • 303 ai • 316 ai	Serie-H-BOP acero • 316 ai	Serie-HS acero • latón • 303 ai	Serie-K acero • 316 ai
	 ISO7241-B página 70	 ISO7241-B BOP página 80	 Flujo ISO7241-B página 82	 ISO7241-A página 85
Serie-AG acero  Agrícola página 91	Serie-V acero • latón • 316 ai  MIL-C-51234 página 95	Serie-TR acero  Europeo página 112	Serie-HT acero • 316 ai  Correct Connect® ISO16028 página 114	Serie-HTE acero  Niple ISO16028 Connect under pressure página 122
Serie-HTZ acero  ISO16028 Cople Connect Under Pressure página 125	Serie-HT-AG acero  ISO16028 - AG ISO7241-A página 126	Serie-ST acero • 316 ai  Flushface Trabajo Pesado página 127	Serie-PD acero  Prueba ISO15171-1 página 133	Serie-VEP acero • 316 ai  Flushface Roscado página 135
Serie-VEP-BOP acero  Flushface BOP Roscado página 140	Serie-W acero • latón  Wingstyle página 142	Serie-WS acero • 316 ai  Wingstyle Trabajo Pesado página 147	Serie-WS-BOP acero • 316 ai  Wingstyle BOP Trabajo Pesado página 153	Serie-T acero • 316 ai  10K Roscado página 155
Serie-CVV acero  Rosca Europea ISO14541 página 158	Serie-TD 316 ai  15K y 20K Roscado página 162	Serie-E acero • latón • 303 ai  Straight-Through página 164	Serie-EA acero  Chorro de Agua página 170	Serie-CM latón  Molde Enfriador página 172

Tabla de Referencia Cruzada

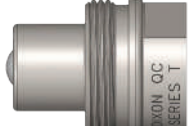
Serie Competidora o Estándar	Fabricante	Serie Dixon	Páginas
Serie 10000	TEMA	Serie TR	112
Serie 1000	Hansen	Serie F	20
Serie 10	Parker	Serie J	30
Serie 1110	Tomco	Serie L	45
Serie 13	Rectus	Serie NK	61
Serie 20	Parker	Serie F	20
210/310	Foster	Serie M	35
210/310	Hansen	Serie M	35
210/310	Milton	Serie M	35
21KA	Rectus	Serie BR	63
Serie 223	CEJN	Serie BR	63
25KA	Rectus	Serie CJ	39
26KA	Rectus	Serie CJ	39
27KA	Rectus	Serie CJ	39
Serie 3000	Hansen	Serie D	20
Serie 3000	Parker/Pioneer	Serie T	155
Serie 30	Parker	Serie D	20
Serie 315	CEJN	Serie NK	61
Serie 320	CEJN	Serie CJ	39
Serie 3800	TEMA	Serie TR	112
Serie 3FFH	Faster	Serie HTE	122
Serie 3	Foster	Serie DF	20
Serie 4000	Parker/Pioneer	Serie AG	91
Serie 4000	Hansen	Serie D	20
Serie 400	Hansen	Serie F	20
Serie 410	CEJN	Serie CJ	39
Serie 4	Foster	Serie DF	20
Serie 5000	Hansen	Serie D	20
Serie 5000	TEMA	Serie TR	112
Serie 500	Hansen	Serie F	20
Serie 50	Parker	Serie M	35
Serie 51000	Bowes	Serie N	49
Serie 5100	Eaton/Aeroquip	Serie W	142
Serie 525	CEJN	Serie TR	112
55KM	Rectus	Serie J	30
Serie 56-Series	Snap-Tite	Serie EA	170
Serie 5-Series	Foster	Serie DF	20
Serie 5TV/6TV	Hydraulics Inc	Serie WS	147
Serie 6000	Hansen	Serie D	20
Serie 60	Parker	Serie H	70

Serie Competidora o Estándar	Fabricante	Serie Dixon	Páginas
Serie 60	Snap-Tite	Serie AG	91
Serie 60 Steam	Parker	Serie HS	82
Serie 6100	Foster	Serie W	142
Serie 6100	Parker	Serie W	142
Serie 61	Snap-Tite	Serie K	85
Serie 6600	Parker	Serie K	85
Serie 6	Foster	Serie DF	20
Serie 70	Parker	Serie L	45
Serie 71	DNP	Serie ST	127
Serie 71	Snap-Tite	Serie ST	127
Serie 72	Snap-Tite	Serie H	70
Serie 74	Snap-Tite	Serie HT	114
Serie 7500	TEMA	Serie TR	112
Serie 75	Snap-Tite	Serie WS/ WS-BOP	147 y 153
Serie 76	Snap-Tite	Serie T	155
Serie 78	Snap-Tite	Serie W	142
A2100/PT400	Tomco	Serie J	30
A-A-50431A	U.S. Government	Serie N	49
A-A-59439	U.S. Government	Serie DF	20
Serie ANV	DNP	Serie K	85
Serie ANV	Faster	Serie K	85
Serie APM	Stucchi	Serie HTE	122
ARO	Intercambio	Serie M	35
Serie A	National	Serie P	57
Serie A	Stucchi	Serie HT	114
Auto-Flo 23	Hansen	Serie U	47
Automotive	Intercambio	Serie J	30
Serie BIR	Stucchi	Serie K	85
Bowes	Intercambio	Serie N	49
Serie B	National	Serie N	49
C604	Enerpac	Serie T	155
Correct Connect®	Trademark	Serie HT	114
Serie CQD	Spir Star	Serie TD	162
Serie CRS	DNP	Serie TD	162
Serie CS	Nycoil	Serie SHD	42
Serie CVV	Faster	Serie CVV	160
Dixlock	Trademark	Serie N	49
Double Lock	Campbell	Serie P	57

Serie Competidora o Estándar	Fabricante	Serie Dixon	Páginas
Serie D	DNP	Serie PD	133
Dual-Lock	Trademark	Serie P	57
Europen Screw-Together	Intercambio	Serie CVV	160
Europeon	Nycoil	Serie CJ	39
Europeon High-Flow	Intercambio	Serie CJ	39
Serie FB	Faster	Serie W	142
FD45	Eaton/Aeroquip	Serie H	70
Serie FD56 (5600)	Eaton/Aeroquip	Serie K	85
Serie FD69	Eaton/Aeroquip	Serie EA	170
Serie FD85	Eaton/Aeroquip	Serie WS	147
Serie FD89	Eaton/Aeroquip	Serie HT	114
Serie FD90	Eaton/Aeroquip	Serie PD	133
Serie FD96	Eaton/Aeroquip	Serie VEP	135
Serie FEC	Parker	Serie HTE	122
Serie FEM	Parker	Serie HT	114
Serie FET	Parker	Serie VEP	135
Serie FF49	Safeway	Serie HT	114
Serie FFEC49	Safeway	Serie HTE	122
Serie FF-GP	DNP	Serie HT	114
Serie FFK	DNP	Serie HTE	122
FFN/FFI/2FFN/2FFI	Faster	Serie HT	114
Serie FF	Hansen	Serie HT	114
Serie FF	Parker	Serie HT3/8" solamente	114
Serie FHK	Foster	Serie H	70
Serie FH	Voswinkel	Serie HTE	122
FIH/FH	Foster	Serie V	95
FIRG	Stucchi	Serie HT	114
Serie FJT	Foster	Serie CM	172
Flo-Temp	Hansen	Serie CM	172
Serie FSI-BOP	DNP	Serie VEP-BOP	140
Serie FS	Hansen	Serie SCV	68
Serie FST	Foster	Serie E	164
Serie FT	Voswinkel	Serie VEP	135
Serie FVEP	Foster	Serie VEP	135
Serie H/IH	Snap-Tite	Serie V	95
HA15000	Hansen	Serie K	85
Serie HCP	Holmbury	Serie HTE	122
Serie HFB	Holmbury	Serie E	164

Serie Competidora o Estándar	Fabricante	Serie Dixon	Páginas
Serie HFT	Holmbury	Serie VEP	135
High Pressure Screw-Together	Intercambio	Serie T	155
Serie HKFR	Eaton/Hansen	Serie H-BOP	80
Serie HK	Hansen	Serie H	70
Serie HNV-BOP	DNP	Serie H-BOP	80
Serie HNVFR	Faster	Serie H-BOP	80
Serie HNV	DNP	Serie H	70
Serie HNV	Faster	Serie H	70
Serie HQ	Holmbury	Serie HT	114
Serie HSS	Holmbury	Serie HT	114
Serie HTN	Holmbury	Serie V	95
Serie IA/IAZ	Holmbury	Serie K	85
Serie IA	Voswinkel	Serie K	85
Serie IB/IBZ	Holmbury	Serie H	70
Serie IB	Voswinkel	Serie H	70
Industrial	Intercambio	Serie DF	20
Serie IRB/IRBO/IRBX	Stucchi	Serie H	70
Serie IRC	Stucchi	Serie TR	112
Serie IR	Stucchi	Serie AG	91
ISO14540	ISO Standard	Serie T	155
ISO14541	ISO Standard	Serie CVV	158
ISO15171-1	ISO Standard	Serie PD	133
ISO16028	ISO Standard	Serie HT	114
ISO5675	ISO Standard	Serie AG	91
ISO6150B	ISO Standard	Serie DF	20
ISO7241-A	ISO Standard	Serie K	85
ISO7241-B	ISO Standard	Serie H	70
Serie IVHP	Stucchi	Serie T	155
Japones Industrial	Intercambio	Serie NK	61
Serie JS	DME	Serie CM	172
Serie LC	Holmbury	Serie WS	147
Lincoln	Intercambio	Serie L	45
Serie MC	Tomco	Serie CM	172
Megaflow	Coilhose	Serie CJ	39
MIL-C-3486	Military Spec	Serie N	49
MIL-C-4109F	Military Spec	Serie DF	20
Mil-C-51234	Military Spec	Serie V	95
Mold Coolant	Intercambio	Serie CM	172
Moldmate	Parker	Serie CM	172

Cross Reference Tool

Serie Competidora o Estándar	Fabricante	Serie Dixon	Páginas
Serie MPX	Staubli	Serie HT	114
Serie MQS-A	Manuli	Serie K	85
Serie MQS-B	Manuli	Serie H	70
Serie MQS-D	Manuli	Serie PD	133
Serie MQS-F	Manuli	Serie HT	114
Serie MQS-FP	Manuli	Serie HTE	122
Serie MQS-SC	Manuli	Serie T	155
Ni-Cupla	Nitto Kohki	Serie NK	61
Serie NS	DNP	Serie AG	91
Serie NS	Faster	Serie AG	91
Serie NS/Jiffy-Tite	DME	Serie CM	172
Serie NV	Faster	Serie AG	91
Serie OGF	Faster	Serie ST	127
Serie OGVFR	Faster	Serie WS-BOP	153
Serie OGV	Faster	Serie WS	147
Serie PD	Parker	Serie PD	133
Serie PHC-	Thor	Serie P	57
Pioneer Agrícola	Intercambio	Serie AG	91
Serie PSB/PSP-	Holmbury	Serie T	155
Serie PST4/FSI	DNP	Serie VEP	135
Serie PVM	DNP	Serie T	155
Serie PVV3	DNP	Serie CVV	158
Serie PVV3	DNP	Serie CVV	158
Serie PVVM/PVSM	Faster	Serie T	155
Quick-Action	MacDonald	Serie N	49
Serie S10	Safeway	Serie H	70
Serie S20	Safeway	Serie AG	91
Serie S30	Safeway	Serie T	155
Serie S51	Safeway	Serie W	142
Serie S56	Safeway	Serie K	85
Schrader	Intercambio	Serie SHD	42
Screw Type	Jet Stream	Serie TD	162
Serie SC	Tomco	Serie BR	63
Serie SHD	Foster	Serie SHD	42
Serie SH	Stucchi	Serie V	95
Single Lock	Campbell	Serie N	49
Serie STG	Inteva	Serie CVV	158
Straight-Through	Intercambio	Serie E	164
ST-Series	DNP	Serie E	164

Serie Competidora o Estándar	Fabricante	Serie Dixon	Páginas
Serie ST	Hansen	Serie E	164
Serie ST	Parker	Serie E	164
Serie ST	Tomco	Serie E	164
TEMA European	Intercambio	Serie TR	112
Serie TF	Foster	Serie J	30
Thor	Intercambio	Serie P	57
Serie TL	Parker	Serie SHD	42
Serie TL	Tomco	Serie SHD	42
Serie TNL	Faster	Serie V	95
Serie TNV	DNP	Serie V	95
Serie TNV	Faster	Serie V	95
Tru-Flate	Eaton/Hansen	Serie J	30
Tru-Flate	Hoffmann	Serie J	30
Twist-Lock	Schrader	Serie SHD	42
Tipo B	Amflo	Serie M	35
Tipo-17	Coilhose	Serie L	45
Tipo-HS	Voswinkel	Serie CVV	160
Serie UC	Coilhose	Serie U	47
Serie UC	Parker	Serie U	47
Serie VD	Stucchi	Serie CVV	160
Serie VEP-HD	Stucchi	Serie VEP-/VEP-BOP-	135 y 140
Serie VEP-P	Stucchi	Serie VEP-/VEP-BOP-	135 y 140
Serie VFF-HD BOP	DNP	Serie WS-BOP	153
Serie VFF-HD	DNP	Serie WS	147
Serie VFF	DNP	Serie W	142
Serie VOF	Stucchi	Serie WS	147
Chorro de Agua	Intercambio	Serie EA	170
Serie WB	DNP	Serie EA	170
Serie WB	Parker	Serie EA	170
Wing Style	Stucchi	Serie W	142
Serie WS56000	Hansen	Serie T	155
Serie WSC	Holmbury	Serie W	142
Serie X64	CEJN	Serie HTE	122
Serie X65/X66	CEJN	Serie HT	114

Identificación de Rosca Macho/Hembra NPTF

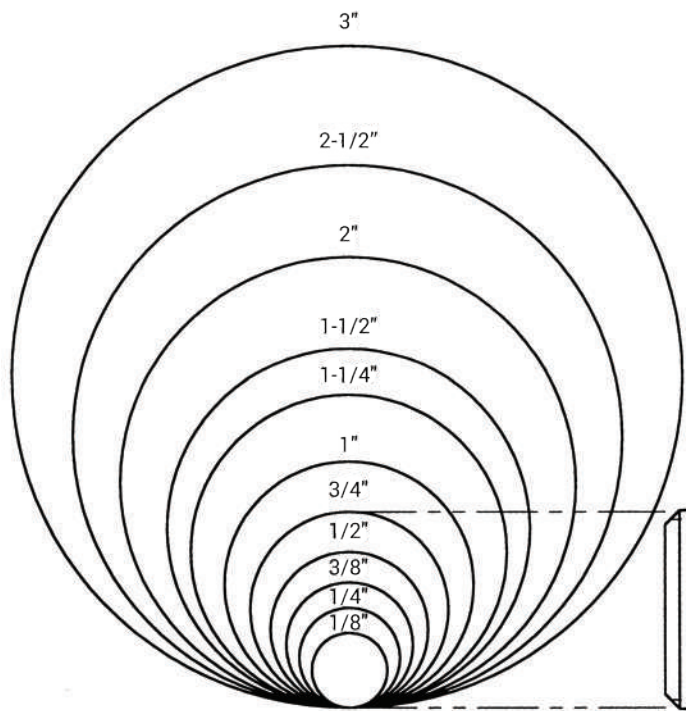

Tamaño Rosca Macho

- Colocar de forma vertical la rosca sobre el diagrama
- Alinea el diámetro exterior de la rosca de tubería con el círculo correspondiente
- Leer el tamaño de la rosca que se indica arriba del círculo

Ejemplo: 3/4" rosca macho
(Medida de extremo Dixon = 6)

Tamaño Rosca Hembra

- Coloca la rosca de tubería en la escala.
- Alinea un lado de la rosca con la base.
- Leer el tamaño del tubo desde la escala.

Medida de Tubería Nominal (pulg)	Tamaño de extremo	Tamaño Nominal Rosca (Pulg)	Tamaño Nominal Tubo (Pulg)
1/8	1	1/8 - 27	0.41
1/4	2	1/4 - 18	0.54
3/8	3	3/8 - 18	0.68
1/2	4	1/2 - 14	0.84
3/4	6	3/4 - 14	1.05
1	8	1-11 - 1/2	1.32
1-1/4	10	1-1/4 - 11-1/2	1.66
1-1/2	12	1-1/2 - 11-1/2	1.90
2	16	2 - 11-1/2	2.38
2-1/2	20	2-1/2 - 8	2.88
3	24	3 - 8	3.50

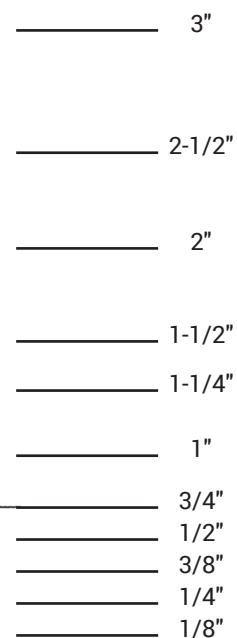

Ejemplo: 3/4" rosca hembra
(Medida de extremo Dixon = 6)

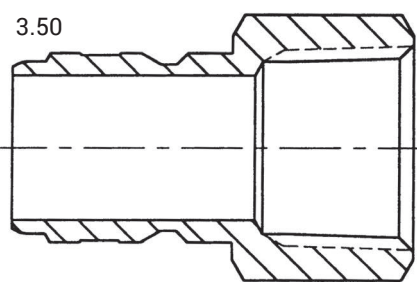

Línea base para tomar medidas
DQC420

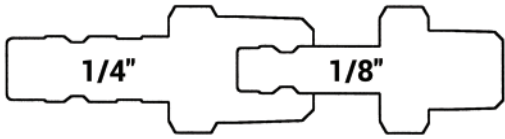

Serie A

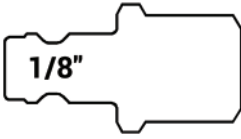

Serie BR

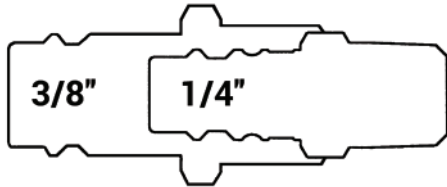

Serie CJ

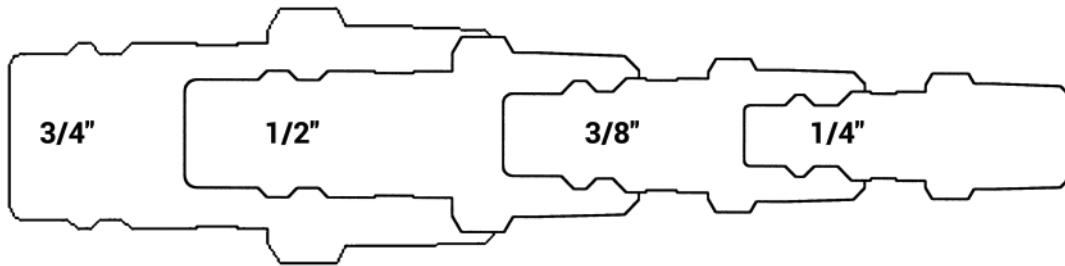

Serie DF

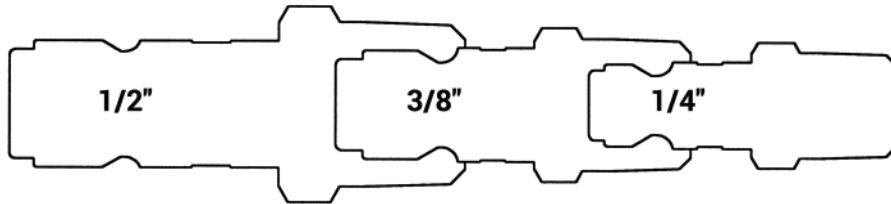

Serie J



Serie M



Serie L

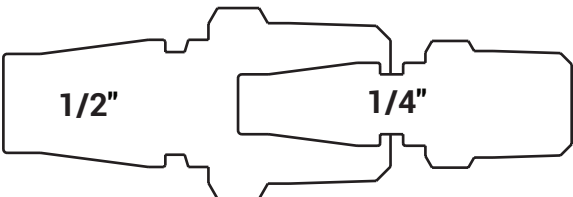

Serie SHD

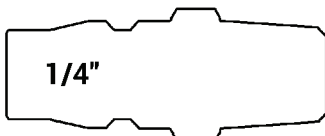

Serie NK

Serie K

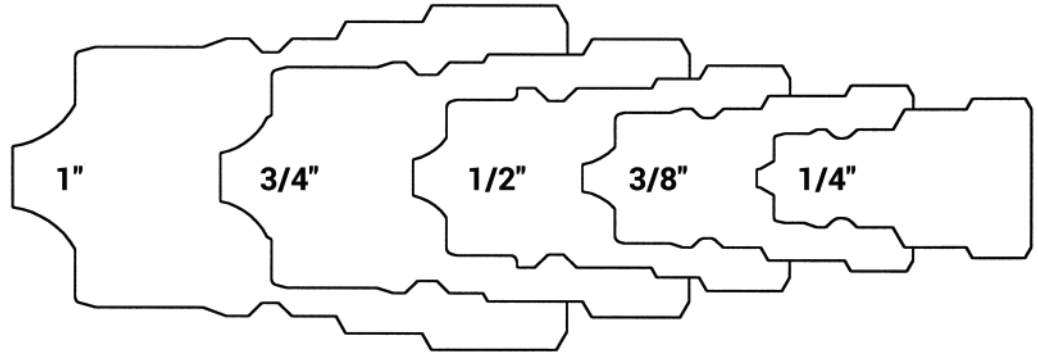

Serie K Grande

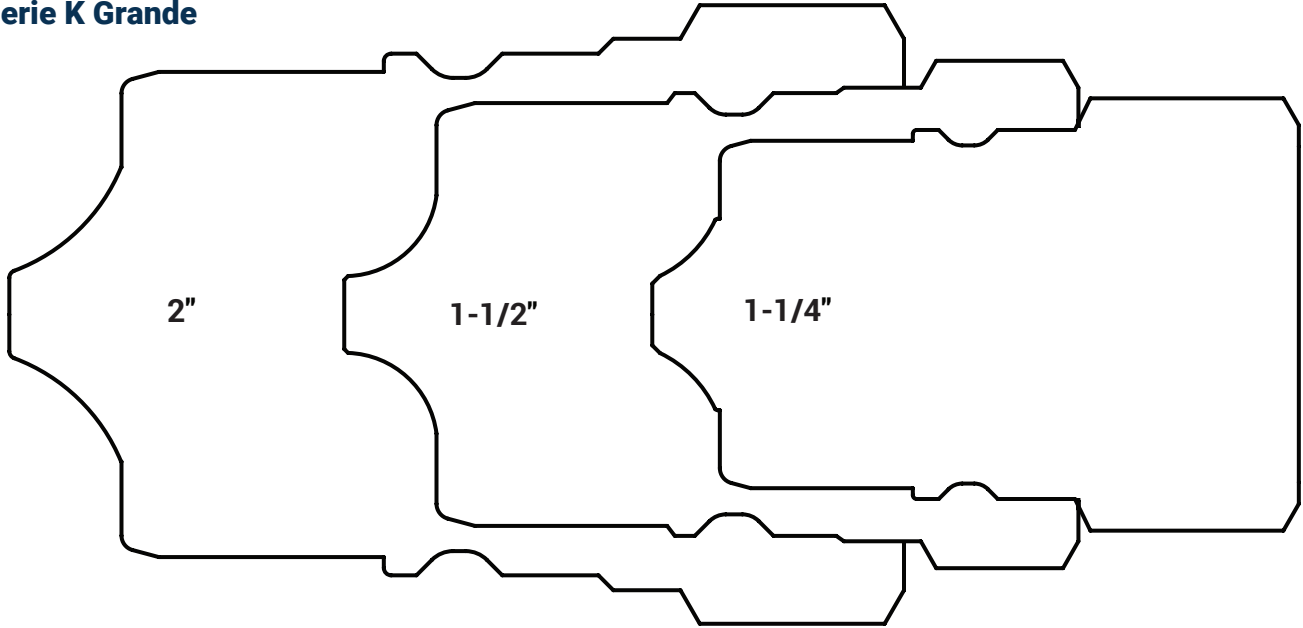

Serie AG

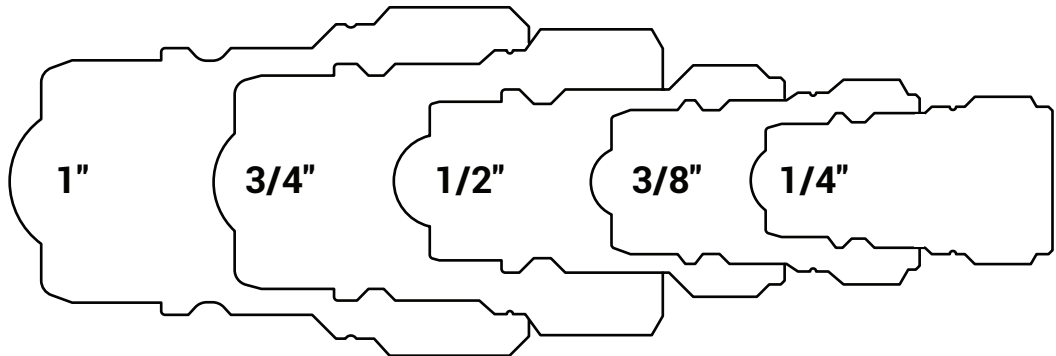

Serie TR

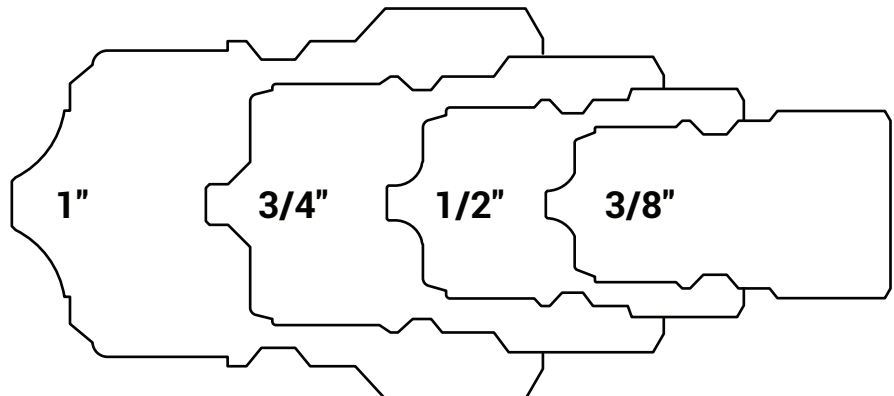

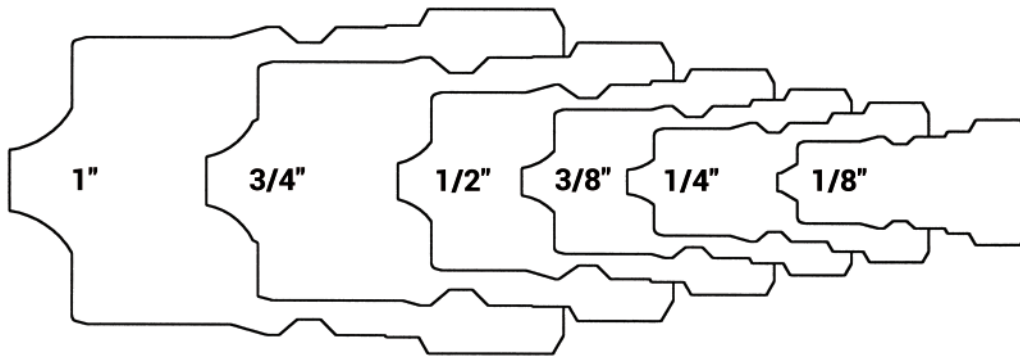

Serie H

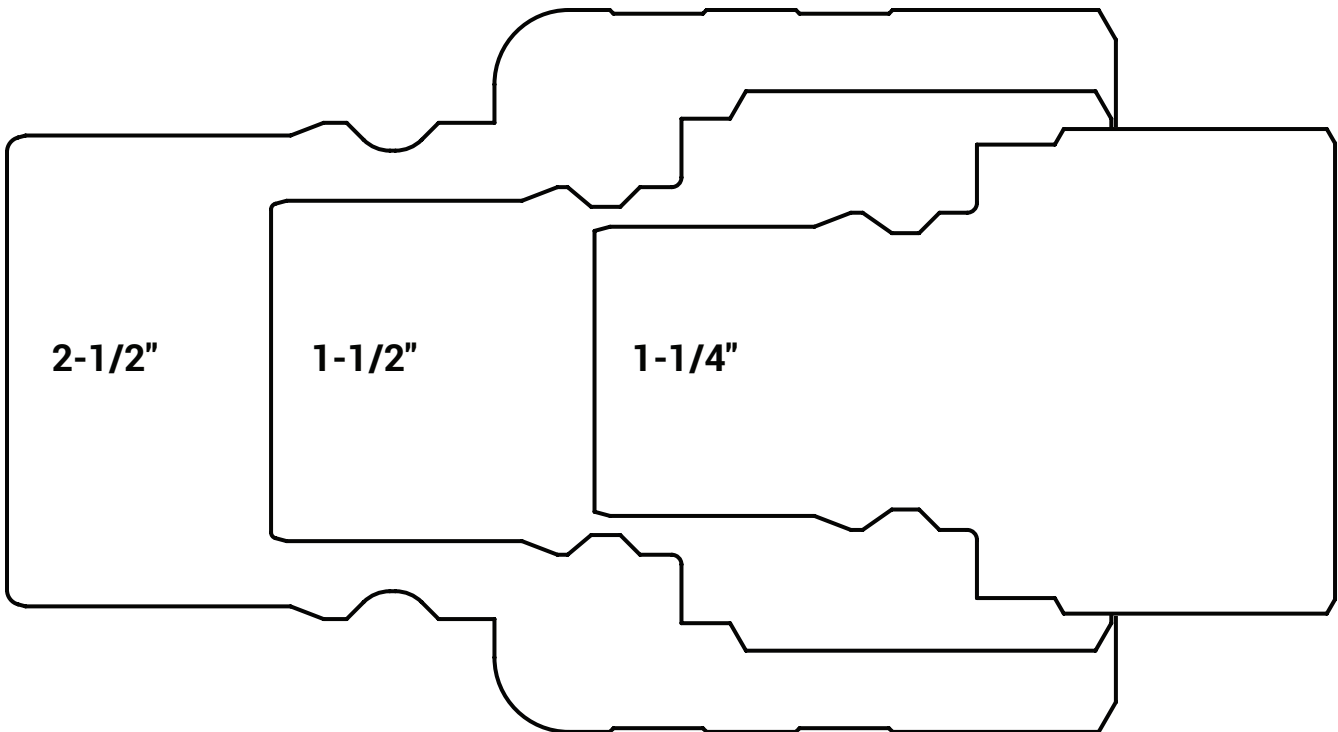

Serie H Grande

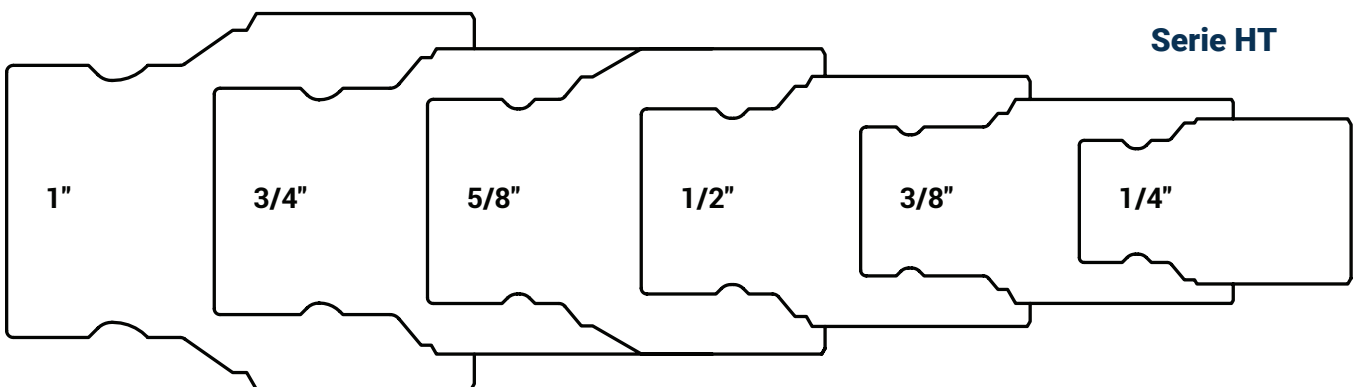

Serie HT

Serie V

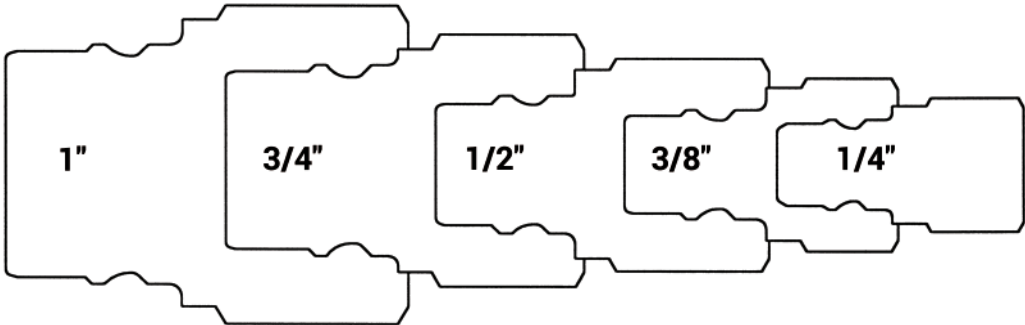

Serie V Grande

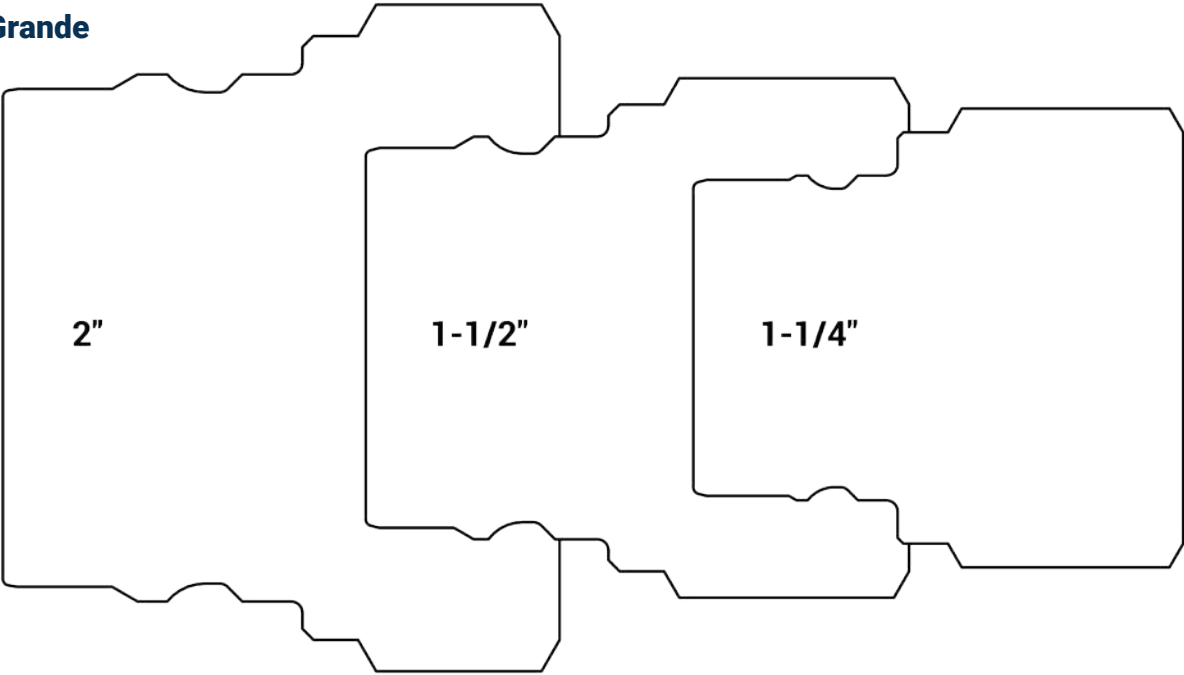

Serie W

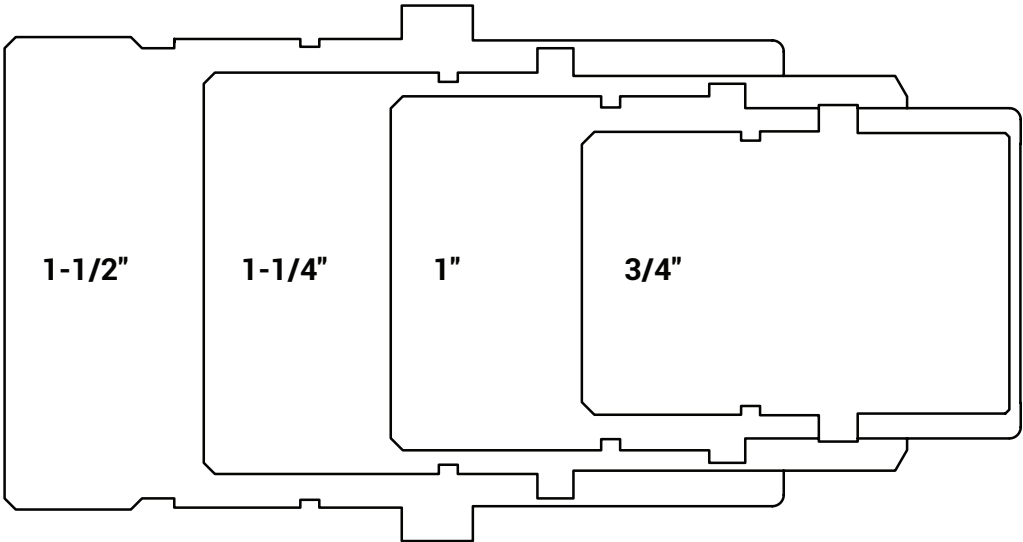

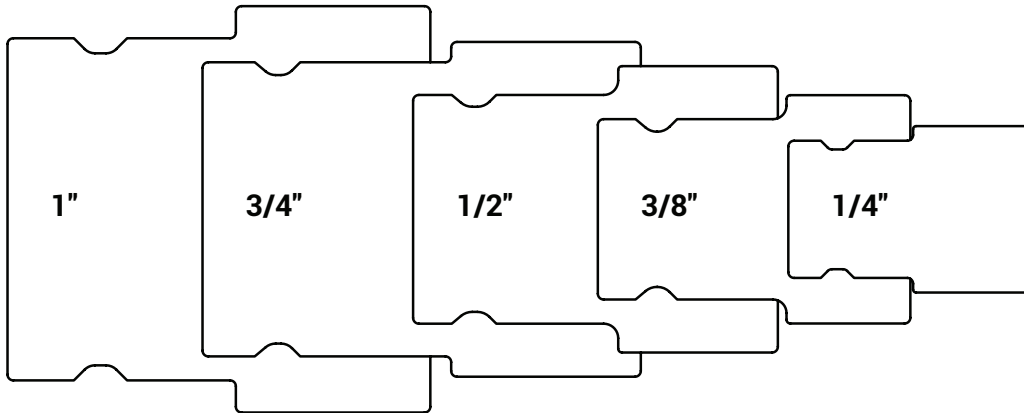

Serie ST

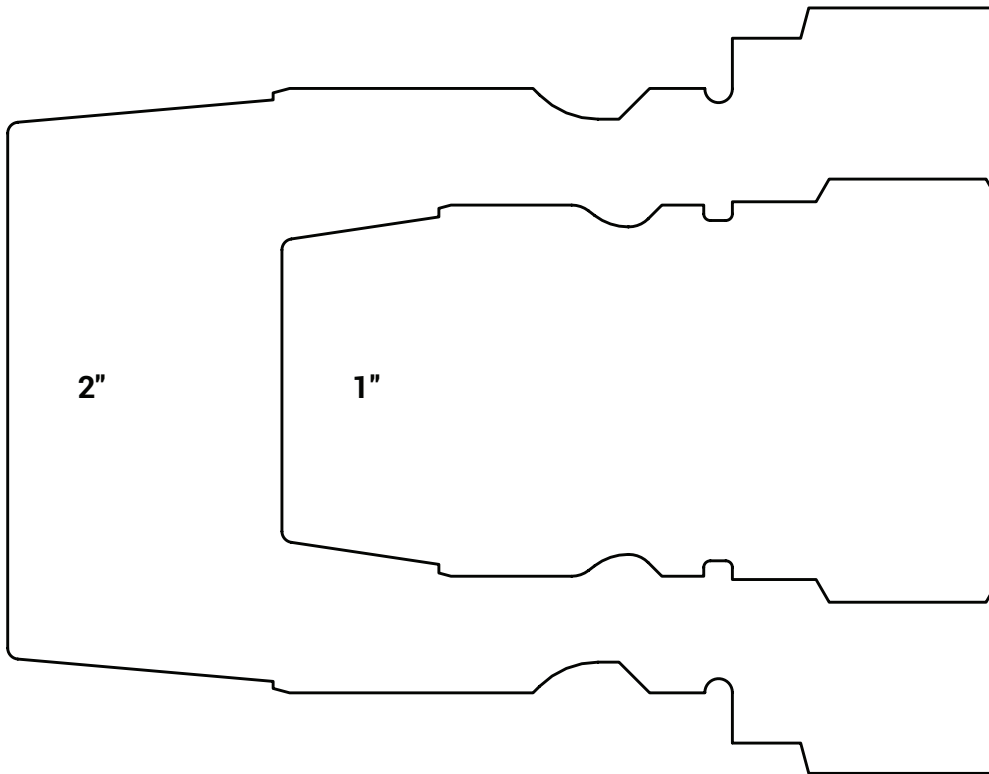

Serie ST Grande

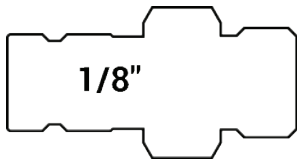

Serie PD

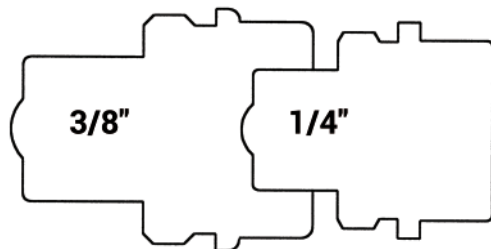

Serie T

Serie E

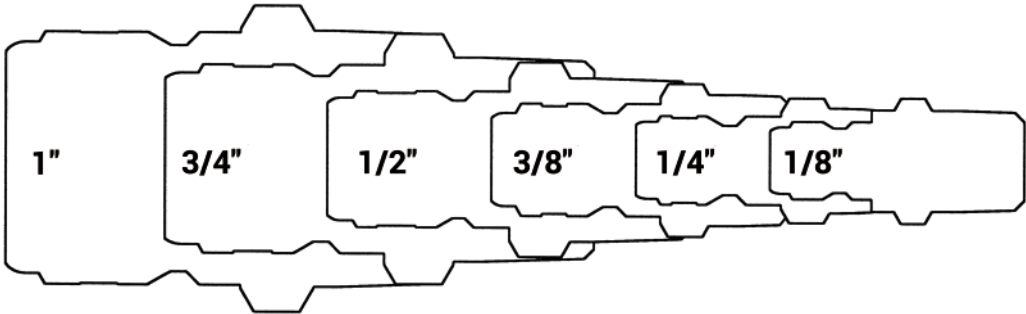

Serie E Grande

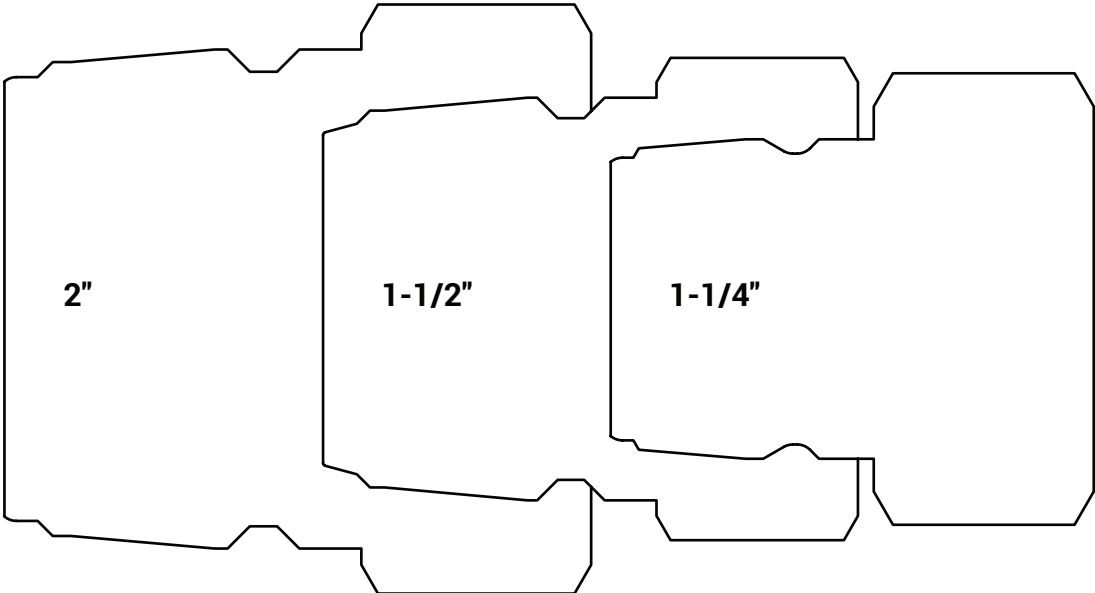

Serie EA

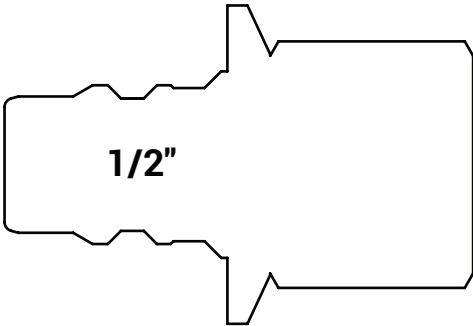

Serie CM

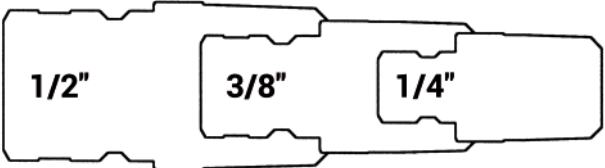

Mantente Seguro Utilizando Acoples Rápidos

! Todos los coples de desconexión rápida deben ser considerados como peligros potenciales que pueden causar daños a la propiedad, accidentes al personal o incluso la muerte si se usan o instalan inapropiadamente. El uso indebido incluye la selección de un producto que no es para tu aplicación, instalar o utilizar de manera errónea el producto, e/o ignorar las señas de un error inminente o mal uso. El fallo puede presentarse como una explosión de componentes, expulsión de productos peligrosos y paro o movimiento inintencional de una máquina hidráulica.

Selección Apropiaada de Acoples Rápidos Dixon

Las propiedades que hacen a los productos comprimidos útiles en cada área de la vida moderna pueden ser peligrosos si no se manejan con cuidado. Los coples de desconexión rápida han sido fabricados para cumplir requerimientos específicos de la industria mientras mantienen márgenes abundantes de seguridad. Si los coples rápidos no se utilizan en sus aplicaciones correctas o se aplican de manera incorrecta, pueden ocurrir accidentes o paros de producción. Depende del cliente final informar al distribuidor de la aplicación y las presiones envueltas cuando ordena coples rápidos y depende del distribuidor suministrar los acoples apropiados para la aplicación.

El uso de S.T.A.M.P.E.D. ayuda en la selección de productos de conexión rápida. Si tienes dudas, Dixon puede brindarte información, incluyendo resultados de pruebas (si están disponibles), recomendaciones de acoplamiento y otra información que ayudan a resolver problemas relacionados con estas conexiones.

S.T.A.M.P.E.D. Preguntas y Proceso de Selección

- Tamaño** Los coples deben ser seleccionados para manejar el flujo y presión del sistema. La caída de presión excedida dará como resultado restricción de flujo, actuación lenta, alta velocidad del fluido, generación de calor y eventualmente el colapso del fluido, sellos y componentes.
1. ¿Qué medida de acople requiere?
 2. ¿Cuál es la máxima caída de presión para la aplicación?
 3. ¿Hay restricciones de medida debido a instalaciones en espacios angostos?
- Temperatura** Las temperaturas del producto y del medio ambiente deben ser limitadas a los parámetros de operación de los materiales de sellado seleccionados. El frío excesivo reduce la capacidad de sellado, mientras que el calor excesivo puede causar un colapso prematuro del cuerpo y los sellos de las válvulas.
1. ¿Cuál es la temperatura del producto/fluido?
 2. ¿Cuál es la temperatura del medio ambiente?
 3. ¿Hay fuentes de calor o temperaturas altas intermitentes cerca de la conexión?
- Aplicación** El intercambio de acoples de conexión rápida deben ser inspeccionados de cerca. Hay severas instancias donde coples no-intercambiables y nipples puedan conectar. Esto es muy peligroso debido a que estos acoples no deben ser presurizados. Asegúrate de embonar coples y nipples con su serie.
1. ¿Es un cople de intercambio industrial requerido?
 2. ¿Cuales son los requerimientos funcionales con el acople?
 3. ¿Han habido problemas con otros acoples en esta aplicación?
- Media** Los acoples rápidos están disponibles en una variedad de materiales y opciones de sello. La exposición a ambientes operativos difíciles y corrosivos puede reducir su vida de utilidad. Muchas conexiones rápidas derraman fluido en su desconexión, lo cual puede ser un problema de seguridad.
1. ¿Cuales materiales de sello y cuerpo son compatibles con el fluido en el sistema?
 2. ¿Es una preocupación la inclusión de aire, la contaminación del sistema o pérdida de fluido?
 3. ¿Este fluido es peligroso para el operador?
- Presión** Durante el proceso de selección, la presión de trabajo del acople publicada debe ser igual o mayor a la presión máxima del sistema. Presiones de sobretensión en un sistema de energía de fluido, más alto que la presión valuada, acortaran la vida de servicio del acople.
1. ¿La presión es "estática" o "dinámica"?
 2. ¿Cuál es la presión máxima de operación requerida para la aplicación?
 3. ¿Hay picos de presión en el sistema?
- Extremos** Muchas configuraciones de extremo están disponibles y cada una tiene parámetros de operación específicos. Por ejemplo, la presión de trabajo de los acoples que utilizan barbas para manguera o collar puede reducirse dramáticamente. Si tiene dudas, realiza pruebas bajo condiciones controladas para ver si es apto para la aplicación.
1. ¿Cuál configuración de extremo y medida es requerida? (rosca macho, rosca hembra o con barbas para manguera)
 2. ¿La configuración de extremo elegida soporta los parámetros de la aplicación y la presión del sistema?
 3. ¿Cuál es la configuración de válvula ideal? (cierre sencillo, doble cierre o sin válvula)
- Detalles** Los detalles ignorados y olvidados pueden causar fallos si no se atienden apropiadamente. Se meticoloso con tu aplicación para asegurar que todos los parámetros hayan sido considerados en la selección del acople rápido apropiado.
1. ¿Hay alguna carga lateral, vibración o problemas giratorios asociados con la aplicación?
 2. ¿El acoplamiento requiere de una manga de seguridad y otro dispositivo?
 3. ¿Hay algún problema ambiental que deba atenderse?

! Los acoples rápidos pueden fallar sin previo aviso. Antes de operar con los acoples rápidos asegúrate de inspeccionar y reemplazar las conexiones gastadas y los dispositivos de seguridad. Si una fuga se detecta durante la operación, libera la presión del circuito antes de investigar la causa de la fuga. No utilices tus dedos o piel para verificar las fugas. Las fugas de presión alta pueden penetrar fácilmente la piel y pueden causar lesiones severas o muerte.

Prácticas de Seguridad

1. Siempre limpia las cavidades del acople y las caras antes de conectar el ensamble.
2. Conecta el acople antes de instalarlo para asegurar que funciona apropiadamente.
3. Siempre verifica los sellos del cuerpo antes de conectar.
4. Apaga toda fuente de poner antes de conectar el acople.
5. Siempre instala una válvula check de seguridad en una línea neumática y/o compresor.
6. Siempre utiliza un cable de seguridad en líneas de aire largas (1/2" y más)
7. Siempre utiliza una whip hose en herramientas neumáticas e hidráulicas.
8. Utiliza tapas y tapones cuando los acoples no están en uso.
9. Si la manga de seguridad es inoperable, verifica el candado de seguridad.
10. Utiliza protección para ojos mientras conecta o desconecta el acople

Prácticas No Recomendables

1. Nunca golpees las válvulas para liberar la presión atrapada
2. Nunca dejes los acoples en áreas de equipo en movimiento.
3. Nunca uses acoples cerca de soldadoras, calores intermitentes o fuentes de calor/flamas.
4. Nunca uses selladores API modificados o apliques demasiada cinta PTFE durante la instalación.
5. Mantenga las precauciones si debe instalar los acoples rápidos en tubería de hierro negra.
6. Nunca golpee la manga del acople con un mazo u otro objeto.
7. Nunca apriete de más la conexión.
8. Nunca gire un acople rápido bajo presión.
9. No sobre-presurice las conexiones rápidas.
10. Nunca utilice una manguera con un acople rápido para levantar una herramienta.

Regulaciones OSHA Brindan la Seguridad del Operador



Cable de Seguridad King Cable®



Válvulas Check de Seguridad

Estándar - 29 CFR, 1926.302 (parcial):

(b)(1) Las herramientas neumáticas deben estar aseguradas a la manguera o "enlace" para prevenir que la herramienta se desconecte accidentalmente.

(b)(2) Los clips de seguridad o retenedores deben estar instalados de manera segura y mantenidos en las herramientas de impacto neumático (percusión) para prevenir que los accesorios sean accidentalmente expulsados.

(b)(4) El aire comprimido no debe usarse para limpieza excepto donde se reduzca a 30 PSI y además se use una guarda y equipo de protección personal que cumpla con los requerimientos Subparte E de esta parte. Los 30 PSI requeridos no aplican a limpieza de concreto, escamas de fundidora y propósitos de limpieza similares.

(b)(5) La presión de operación segura brindada por el fabricante para mangueras, tubería, válvulas, filtros y otras conexiones no debe excederse.

(b)(6) El uso de mangueras para levantar o bajar herramientas no está permitido.

(b)(7) Todas las mangueras que excedan el diámetro interior de 1/2" deben tener un dispositivo de seguridad en la fuente de suministro o ramificación para reducir la presión en caso de que falle una manguera.

Standard - 29 CFR, 1926.603 (parcial):

(a)(9) La manguera de vapor que va hacia un martillo de vapor o tubería jet debe estar conectada de manera segura al martillo con una cadena de longitud adecuada de al menos 1/4" de diámetro o cable para prevenir el látigo en caso de que la junta del martillo esté rota. Los martillos neumáticos deben procurarse con la misma protección que se requiere en líneas de vapor.

(a)(10) Las cadenas de seguridad, o equivalentes, deben brindarse para cada conexión de manguera, esto previene que la línea se agite en caso de que el acople se desconecte.

Las regulaciones pueden verse por completo en el sitio web de OSHA, osha.gov. Por favor verifique las actualizaciones en el sitio web.



Mantente Seguro Utilizando Acoples Rápidos
 Todos los coples rápidos deben ser vistos como peligros potenciales que pueden causar daños a la propiedad, accidentes al personal e incluso muerte si se utiliza o se instala de manera inapropiada.

Los coples deben instalarse en un lugar que permita una fácil operación del acople y acceso para las instalaciones necesarias de la herramienta. Debe tomar precauciones considerando la seguridad del operador especialmente si puede llegar a ocurrir una desconexión accidental con fluido inflamable o que provoque irritación en piel y ojos.

Solamente utilice llaves con los hexágonos o superficies maquinadas para llave que se brindan para propósito de ensamblado. No utilice abrazaderas en la manga del acople o en la nariz del niple por qué esto puede causar distorsión y/o daños.

Finalmente, siempre pon a prueba la instalación del acople rápido antes de ponerlo en operación presurizando la unidad a 150% de su presión de trabajo en un ambiente cerrado/protegido..

Instalación de Conexiones de Cara Plana (NPTF)

El sello para las roscas NPTF se crea con el contacto metal-a-metal entre la raíz y la cresta de las roscas macho y hembra. Utilizar mucha cinta PTFE o utilizar sellador líquido con cinta PTFE puede causar distorsión, un sellado de roscas pobre o grietas en el acople durante el ensamble.

El número total hilos en la rosca deben estar entre 3-1/2 a 6. Cualquier número de hilos en la rosca fuera de este rango puede indicar que no esta apretado o que está muy apretada la junta o las roscas no lo toleran. Después de ensamblar la conexión NPTF, siempre realiza pruebas en la conexión antes de operar el sistema. Si la junta muestra estar apretada de manera inadecuada durante la prueba, aprieta en incrementos de 1/8 hasta obtener el sello deseado. (No excedas las 3 vueltas después de apretar a mano).

1



Aplica 1-1/2 a 2 vueltas de cinta PTFE, comenzando en uno o dos hilos de rosca del borde en dirección de las manecillas del reloj. Para acero inoxidable asegúrate de utilizar cinta de grado inoxidable.

2



Verifica las roscas para asegurar que no haya daños en cualquiera de las mitades y que la cinta ha sido propiamente instalada. Alinea las conexiones macho y hembra y cuidadosamente comienza a roscar las dos mitades.

3

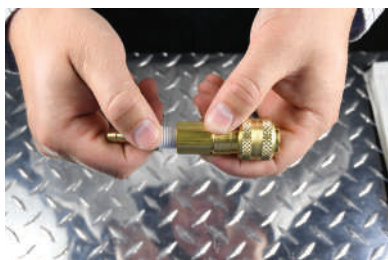

Aprieta con los dedos la conexión y haz una marca de referencia en el hexágono del extremo de manguera/ adaptador y el cople. Esta marca ayudará a identificar el número de revoluciones durante el siguiente paso del procedimiento.

4



Aprieta de acuerdo a los valores recomendados TFFT listados debajo. NO SOBRE-APRIETE.

Medida SAE	Rosca NPTF	TFFT
-4	1/4" - 18	2
-6	3/8" - 18	2
-8	1/2" - 14	2
-12	3/4" - 14	1.5
-16	1" - 11-1/2	1.5

Mantente Seguro Instalando Acoples Rápidos

Instalación de Conexiones con O-ring Boss (ORB)



Ligeramente lubrica el O-ring del adaptador y róscalo dentro del acople. Aprieta con la mano, asegurate que el O-ring no está mal colocado durante la instalación.



Aprieta con la llave la conexión al torque especificado debajo.

Medida SAE	Medida de Rosca	Torque (Nm)	Torque (lb-ft)
-4	7/16" - 20	18 - 20	13 - 15
-6	9/16" - 18	29 - 33	22 - 24
-8	3/4" - 16	49 - 53	40 - 43
-10	7/8" - 14	59 - 64	43 - 48
-12	1-1/16" - 12	93 - 102	68 - 75
-16	1-5/16" - 12	151 - 166	112 - 123
-20	1-5/8" - 12	198 - 218	146 - 161
-24	1-7/8" - 12	209 - 231	154 - 170

Instalación de Conexiones de 37° Abocinadas (JIC)



Ligeramente lubrica el abocinado del adaptador y róscalo dentro del acople. Aprieta con la mano para asegurarte que el abocinado ha sentado correctamente durante la instalación.



Aprieta con la llave la conexión al torque especificado debajo.

Medida SAE	Medida de Rosca	Torque (Nm)	Torque (lb-ft)
-4	7/16" - 20	15 - 16	11 - 12
-6	9/16" - 18	24 - 28	18 - 20
-8	3/4" - 16	49 - 53	36 - 39
-10	7/8" - 14	77 - 85	57 - 63
-12	1-1/16" - 12	107 - 119	79 - 88
-16	1-5/16" - 12	147 - 154	108 - 113
-20	1-5/8" - 12	172 - 181	127 - 133
-24	1-7/8" - 12	215 - 226	158 - 167

Mantente Seguro Instalando Acoples Rápidos

Instalación de Acoples para Manguera Reutilizables

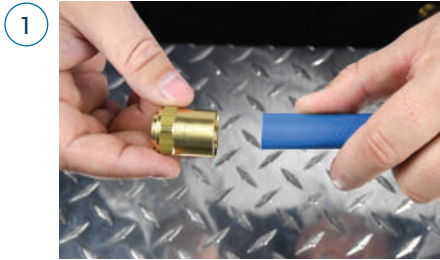

Corte el extremo de la manguera a 90° grados



Instala la férula deslindola dentro del extremo de la manguera y girando en sentido a las manecillas del reloj.

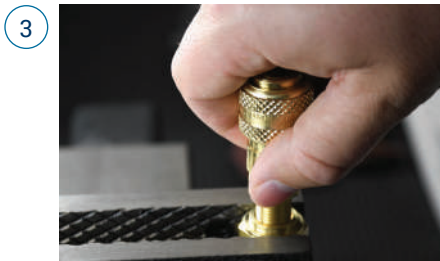

Aplica lubricante a la barba reutilizable antes de insertarlo en la nueva férula.



Gira la conexión reutilizable dentro de la férula hasta que el acople se haya sentado contra la férula.

Instalación de Conexiones Push-Loc

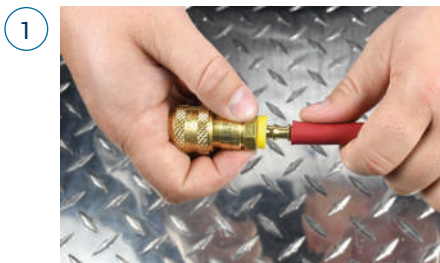

Corta la manguera y lubrica la barba Push-loc y la manguera. Inseta la barba push-loc dentro de la manguera hasta que la primer barba esté dentro.



Coloca el extremo de la manguera contra la parte plana y la agarradera de la manguera a una pulgada del extremo. Empuja con fuerza el extremo hasta que el extremo de la manguera se cubra con la tapa de plástico amarilla.

Mantente Seguro Instalando Acoples Rápidos

Instalación de Serie N y Serie P con Férulas

Ten en cuenta de que las tablas debajo son solamente una guía y no una regla para cada aplicación. En algunos casos se pueden utilizar otras medidas de dados y dimensiones de crimpado. Las mangueras, al igual que los acoples, reaccionan diferente durante el crimpado. Esto es debido a que hay variaciones en construcciones de manguera con dimensiones similares. Algunas variables son: trenzado textil versus trenzado de alambre, muro duro versus muro suave, con o sin espiral así como diferencias en las cubiertas de manguera. Además, el diámetro exterior de la manguera tiende a fluctuar de extremo a extremo y de área de producción a área de producción. Con esto en mente, sugerimos que midas bien el DE de la manguera y mantengas un registro de cada aplicación.

DI Manguera	DE Manguera en Fracciones	DE Manguera Decimal	Medida Crimpado 'N'	Crimpado 'N' DE ±.005	Medida Crimpado 'P'	Crimpado 'P' DE ±.005
1/2"	54/64"	0.844	1-1/8"	0.917	1-1/4"	0.917
	55/64"	0.859	1-1/8"	0.929	1-1/4"	0.929
	56/64"	0.875	1-1/8"	0.942	1-1/4"	0.942
	57/64"	0.891	1-1/8"	0.954	1-1/4"	0.954
	58/64"	0.906	1-1/8"	0.967	1-1/4"	0.967
	59/64"	0.922	1-1/8"	0.980	1-1/4"	0.980
	60/64"	0.938	1-1/8"	0.992	1-1/4"	0.992
	61/64"	0.953	1-1/8"	1.005	1-1/4"	1.005
	62/64"	0.969	1-1/8"	1.018	1-1/4"	1.018
	63/64"	0.984	1-1/8"	1.030	1-1/4"	1.030
	1"	1.000	1-1/8"	1.043	1-1/4"	1.043
	1-1/64"	1.016	1-1/8"	1.056	1-1/4"	1.056
1-2/64"	1.031	1-1/8"	1.068	1-1/4"	1.068	
3/4"	1-10/64"	1.156	1-1/4"	1.220	1-1/4"	1.220
	1-11/64"	1.171	1-1/4"	1.235	1-1/4"	1.235
	1-12/64"	1.187	1-1/4"	1.244	1-1/4"	1.244
	1-13/64"	1.203	1-1/4"	1.260	1-1/4"	1.260
	1-14/64"	1.218	1-1/4"	1.270	1-1/4"	1.270
	1-15/64"	1.234	1-1/4"	1.285	1-1/4"	1.285
	1-16/64"	1.250	1-1/4"	1.295	1-1/4"	1.295
	1-17/64"	1.265	1-1/4"	1.310	1-1/4"	1.310
	1-18/64"	1.281	1-1/4"	1.320	1-1/4"	1.320
	1-19/64"	1.296	1-1/4"	1.335	1-1/4"	1.335
	1-20/64"	1.312	1-1/4"	1.345	1-1/4"	1.345
	1-21/64"	1.328	1-1/4"	1.360	1-1/4"	1.360
1-22/64"	1.343	1-1/4"	1.370	1-1/4"	1.370	

Instalación de Férulas para Trabajo Pesado

DI Manguera	DE Manguera en Fracciones	DE Manguera Decimal	Dixon # de Parte	Grosor de Férula	SMOD	% Compresión	Diámetro de Crimpado
1/2"	54/64"	0.8438	CCF0906	0.024	0.513	15	0.853
	55/64"	0.8594	CCF0906	0.024	0.513	15	0.866
	56/64"	0.8750	CCF0906	0.024	0.513	15	0.880
3/4"	1-5/64"	1.0781	CCF1120	0.030	0.763	20	1.086
	1-6/64"	1.0938	CCF1120	0.030	0.763	20	1.098
	1-7/64"	1.1094	CCF1149	0.030	0.763	20	1.111
	1-8/64"	1.1250	CCF1149	0.030	0.763	20	1.123
	1-9/64"	1.1406	CCF1190	0.025	0.763	20	1.126
	1-10/64"	1.1563	CCF1190	0.025	0.763	20	1.138
	1-11/64"	1.1719	CCF1218	0.025	0.763	20	1.151
	1-12/64"	1.1875	CCF1218	0.025	0.763	20	1.163
	1-13/64"	1.2031	CCF1246	0.030	0.763	20	1.186
	1-14/64"	1.2188	CCF1246	0.030	0.763	20	1.198
	1-15/64"	1.2344	CCF1277	0.030	0.763	20	1.211
	1-16/64"	1.2500	CCF1277	0.030	0.763	20	1.223
1"	1-25/64"	1.3906	CCF1430	0.030	1.007	20	1.380
	1-26/64"	1.4063	CCF1430	0.030	1.007	20	1.392
	1-27/64"	1.4219	CCF1469	0.030	1.007	20	1.405
	1-28/64"	1.4375	CCF1469	0.030	1.007	20	1.417
	1-29/64"	1.4531	CCF1500	0.030	1.007	20	1.430
	1-30/64"	1.4688	CCF1500	0.030	1.007	20	1.442
	1-31/64"	1.4844	CCF1530	0.030	1.007	20	1.455
	1-32/64"	1.5000	CCF1530	0.030	1.007	20	1.467

Guía de Compatibilidad de Fluidos

! La siguiente tabla es solamente una guía para seleccionar una variedad de elastómeros y metales para utilizar con fluidos que pasan a través de los acoples de desconexión rápida. Este listado no garantiza que sea apto para una aplicación en especial. La selección final depende de la presión de operación, fluido y temperatura ambiente, concentración del producto, tiempo de exposición, condiciones ambientales y la frecuencia de conexión y desconexión.

Material	Prefijo	Nombre Comercial	Disponibilidad	Rango °F	Rango °C
Buna-N	Estándar	Nitrilo	Stock	-40°F a 250°F	-40°C a 121°C
Buna-N (Fluidos MIL-H-5606)	M-	Nitrilo	1-2 semanas	-65°F a 275°F	-54°C a 135°C
Buna-N (Combustible Hidrocarbono)	JF-	Nitrilo	1-2 semanas	-65°F a 160°F	-54°C a 71°C
Hule Fluorocarbon	F-	FKM	1-2 semanas	-20°F a 400°F	-29°C a 204°C
Etil Propileno Dieno Monomero	P-	EPDM	1-2 semanas	-65°F a 300°F	-54°C a 149°C
Neopreno	E-	Neopreno	1-2 semanas	-45°F a 300°F	-43°C a 149°C
Silicón	S-	Silicón	1-2 semanas	-100°F a 350°F	-73°C a 177°C
Fluorosilicona (FVMQ)	FS-	Silastic®	1-2 semanas	-76°F a 376°F	-60°C a 180°C
Uretano	U-	Uretano	3-4 semanas	-40°F a 180°F	-40°C a 82°C
Poliuretano	UP-	Poliuretano	3-4 semanas	-65°F a 212°F	-54°C a 100°C
Silicón Encapsulado PTFE	TS-	TES	3-4 semanas	-100°F a 400°F	-73°C a 204°C
PTFE Encapsulado Fluorocarbon	TF-	TEF	3-4 semanas	-100°F a 400°F	-73°C a 204°C
Perfluoroelastómero (Compuesto 1)	K4-	Kalrez® 4079	6-8 semanas	-4°F a 600°F	-20°C a 316°C
Perfluoroelastómero (Compuesto 2)	K6-	Kalrez® 6375	6-8 semanas	-4°F a 525°F	-20°C a 275°C
Perfluoroelastómero (Compuesto 3)	K7-	Kalrez® 7075	6-8 semanas	-4°F a 620°F	-20°C a 327°C
Fluoroelastómero	H-	Aflas®	3-4 semanas	23°F a 400°F	-5°C a 204°C

Nombre del Producto	Sello Sugerido	Nombre del Producto	Sello Sugerido	Nombre del Producto	Sello Sugerido
Anhídrido Acético	P-	Freon, General	E-	Aguarrás	Estándar
Acetona	P-	Hidróxido de hierro	Estándar	Acetato de Níquel	P-
Acetileno	Estándar	Formaldehído (50%)	P-	Sulfato de Níquel	P-
Aire (a 200°F)	Estándar	Aceites Combustibles, General	Estándar	Gas Nitrógeno	Estándar
Aire (Arriba de 200°F)	F-	Gasolina	Estándar	Óxido Nitroso	Estándar
Alcohol, Etil	P-	Glicerina (Gliceról)	Estándar	Octano	F-
Alcohol, Metil	Estándar	Glycols	P-	Esencias Oléicas	Estándar
Álcali, General	Estándar	Helio	Estándar	OS45 y OS45-1	F-
Amoníaco, Acuoso	P-	Heptano	Estándar	Oxígeno, No-respirable	F-
Amoníaco, Gas	P-	Hexano	Estándar	Solvente de Pintura	F-
Amoníaco, Anhidro	P-	Aceite Hidráulico Aéreo	Estándar	Parafina	Estándar
Hidroxido de Amonio	P-	Aceite Hidráulico Petróleo	Estándar	Aceite de Cacahuete	Estándar
Aroclor	F-	Aceite Hidráulico, Fosfato	P-	Pentano	Estándar
Benzeno (Benzol)	F-	Gas Hidrógeno	Estándar	Percloroetileno	F-
Soluciones de cloro	P-	Hydrolube	Estándar	Ácido Fosfórico (100%)	P-
Líquido de frenos, no petro	P-	Alcohol Isobutil	P-	Soluciones Fotográficas	P-
Gas Bromo	F-	Alcohol Isopropil	F-	Acetato de Potasio	P-
Alcohol Butil	Estándar	Jet Fuel (a 160°F)	JF-	Propileno	F-
Dioxido de Carbono, Seco	Estándar	Jet Fuel (arriba de 160°F)	F-	Propilenglicol	Estándar
Dioxido de Carbono, Humedo	Estándar	Keroseno	Estándar	Aceite de Silicón	Nitrilo
Monóxido de Carbono	Estándar	Lindol	P-	Vapor, Servicio General	H-
Cloruro de Carbono	F-	Hidroxido de Magnesio	F-	Solvente Stoddard	Estándar
Cellulube	P-	Metano	Estándar	Ácido Sulfúrico (100%)	F-
Creosota	F-	Metanol	Estándar	Tolueno	F-
Petróleo Crudo	F-	Bromuro de Metilo	F-	Fluido de Transmisión (A)	Estándar
Aceite de Corte	Estándar	Metil Etil Cetona (MEK)	P-	Tricloroetileno	F-
Combustible Diesel	Estándar	MIL-F-81912 (JP-9)	P-	Trementina	Estándar
Lubricantes Diesel	F-	MIL-H-5606	M1-	Aceite Vegetal	Estándar
Etano	Estándar	MIL-H-5806	Estándar	Agua	Estándar
Etanol	P-	MIL-H-6083	Estándar	Agua Destilada	Estándar
Cloroetano	Estándar	MIL-H-7083	Estándar	Agua Desionizada	Estándar
Etilenglicol	P-	Aceites Minerales	Estándar	Agua de Mar	P-

Coples Neumáticos: Serie-DF

Información de Intercambio

- Parker serie-20 intercambio manual (Serie F)
- Parker serie-30 intercambio automático (Serie D)
- Foster serie 3, 4, 5, y 6
- Hansen 1000, 400, 500 (Serie F)
- Hansen 3000, 4000, 5000, 6000 (Serie D)

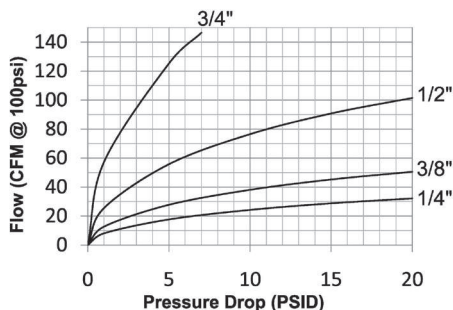

Materiales

- Los componentes son maquinados con barras sólidas de acero, latón o acero inoxidable 303.
- Los balines de acero inoxidable, anillos de retención y resortes maximizan la resistencia a la corrosión y extienden la vida de servicio.
- Los componentes de acero son platinados con cromo trivalente y cumplen con la norma ROHS
- Los acoples automáticos se construyen de latón con válvula de acero tubular como estándar (los acoples de 3/8\" a 3/4\" tienen válvulas de acero)
- Los acoples manuales de 1/4\" se construyen de latón con manga de acero y válvula tubular de acero como estándar.
- Coples manuales de 3/8\" y 1/2\" son construidos estándar con acero y válvula tubular de acero.

Componentes para Sellos

- Sellos de Nitrilo (Buna-N) estándar brindan un rango de temperatura de -40°F a 250°F (-40°C a 121°C)

Tabla de Presión Nominal

Medida	Serie-D Intercambio Industrial Automático (Conectado)															
	Cople Latón/Niple Acero				Cople/Niple Latón				Cople/Niple Acero				Cople/Niple A.I. 303			
	Max. Trabajo		Reventón		Max. Trabajo		Reventón		Max. Trabajo		Reventón		Max. Trabajo		Reventón	
	PSI	Bar	PSI	Bar	PSI	Bar	PSI	Bar	PSI	Bar	PSI	Bar	PSI	Bar	PSI	Bar
1/4"	500	35	16,000	1,100	300	20	16,000	1,100	-	-	-	-	500	35	26,000	1,795
3/8"	500	35	15,500	1,070	300	20	14,500	1,000	-	-	-	-	500	35	25,500	1,760
1/2"	500	35	14,000	965	300	20	10,500	725	-	-	-	-	500	35	20,500	1,415
3/4"	500	35	10,000	670	-	-	-	-	-	-	-	-	-	-	-	-

Medida	Serie-F Intercambio Industrial Manual (Conectado)															
	Cople Latón/Niple Acero				Cople/Niple Latón				Cople/Niple Acero				Cople/Niple A.I. 303			
	Max. Trabajo		Reventón		Max. Trabajo		Reventón		Max. Trabajo		Reventón		Max. Trabajo		Reventón	
	PSI	Bar	PSI	Bar	PSI	Bar	PSI	Bar	PSI	Bar	PSI	Bar	PSI	Bar	PSI	Bar
1/4"	500	35	9,000	620	300	20	8,500	586	500	35	6,500	448	500	35	11,500	795
3/8"	500	35	11,500	790	300	20	10,000	690	500	35	19,500	1,345	500	35	20,500	1,415
1/2"	-	-	-	-	-	-	-	-	500	35	15,500	1,070	500	35	15,000	1,035

Especificaciones Técnicas

Medida	Estándar Intercambiable				Parámetros Funcionales					
	Ejército USA	Gobierno USA	Estándares Internacionales	Estándares ANSI/NFPA	Cant. Balines	Inclusión de Aire	Pérdida de Flujo	Vacío	Flujo ΔP=15 PSI	
1/4"	MIL-C-4109F	A-A-59439	ISO6150B	T3.20.14-1990	6	N/A	N/A	N/R	27 CFM	
3/8"	-	-	ISO6150B	T3.20.14-1990	6	N/A	N/A	N/R	45 CFM	
1/2"	MIL-C-4109F	A-A-59439	ISO6150B	T3.20.14-1990	6	N/A	N/A	N/R	91 CFM	
3/4"	-	-	-	T3.20.14-1990	9	N/A	N/A	N/R	200 CFM	

Opciones Disponibles

Me- di- da	Opciones de Sello		Opciones de Válvula			Opciones de Manga				Tratamiento
	FKM	EPDM	Sin Válvula	Latón	A.I. 303	Brida	Sleeve-Lock	Latón	A.I. 303	Oxy-Clean
	Pre	Pre	Suf	Suf	Suf	Suf	Suf	Suf	Suf	Suf
1/4"	F-	P-	-E	-BV	-SV	N/A	-LS	-BS	-XS	-C1
3/8"	F-	N/A	-E	-BV	-SV	N/A	-LS	N/A	-XS	-C1
1/2"	F-	N/A	-E	-BV	-SV	N/A	-LS	N/A	-XS	-C1
3/4"	N/A-	N/A	-E	N/A	N/A	N/A	-LS	-BS	N/A	-C1

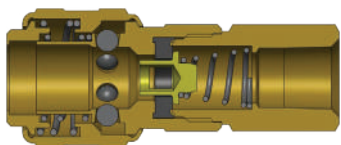

Medida	Serie-D Cople Intercambio Industrial Automático (Rosca Hembra)							
	Detalle			Medida		DE Máximo		Hex Pulg
	# de Parte	Roscas	Material	pulg	mm	pulg	mm	
1/4"	2DF1-B	1/8" - 27 NPTF	latón	2.19	55.6	0.99	25.1	11/16"
	2DF2-B	1/4" - 18 NPTF	latón	2.38	60.5	0.99	25.1	11/16"
	2DF2-S	1/4" - 18 NPTF	A.I. 303	2.38	60.5	0.99	25.1	11/16"
	2DBF2-B	1/4" - 19 BSPP	latón	2.38	60.5	0.99	25.1	11/16"
	2DF3-B	3/8" - 18 NPTF	latón	2.38	60.5	0.99	25.1	11/16"
	2DF3-S	3/8" - 18 NPTF	A.I. 303	2.38	60.5	0.99	25.1	13/16"
3/8"	2DBF3-B	3/8" - 19 BSPP	latón	2.38	60.5	0.99	25.1	13/16"
	3DF2-B	1/4" - 18 NPTF	latón	2.50	63.5	1.26	32.0	7/8"
	3DF3-B	3/8" - 18 NPTF	latón	2.60	66.0	1.26	32.0	7/8"
	3DF3-S	3/8" - 18 NPTF	A.I. 303	2.60	66.0	1.26	32.0	7/8"
	3DBF3-B	3/8" - 19 BSPP	latón	2.60	66.0	1.26	32.0	7/8"
1/2"	3DF4-B	1/2" - 14 NPTF	latón	2.80	71.1	1.26	32.0	1"
	4DF3-B	3/8" - 18 NPTF	latón	3.10	78.7	1.38	35.1	1-1/16"
	4DF4-B	1/2" - 14 NPTF	latón	3.30	83.8	1.38	35.1	1-1/16"
	4DF4-S	1/2" - 14 NPTF	A.I. 303	3.30	83.8	1.38	35.1	1-1/16"
	4DBF4-B	1/2" - 14 BSPP	latón	3.30	83.8	1.38	35.1	1-1/16"
	4DF6-B	3/4" - 14 NPTF	latón	3.40	86.4	1.38	35.1	1-3/16"
3/4"	6DF4-B	1/2" - 14 NPTF	latón	2.95	74.9	1.73	43.9	1-5/16"
	6DF6-B	3/4" - 14 NPTF	latón	2.99	75.9	1.73	43.9	1-5/16"
	6DF8-B	1" - 11-1/2 NPTF	latón	3.18	80.8	1.73	43.9	1-1/2"

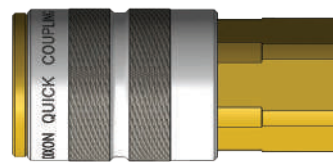
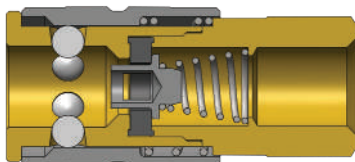

Medida	Serie-F Cople Intercambio Industrial Manual (Roscas Hembra)							
	Detalle			Medida		DE Máximo		Hex Pulg
	# de Parte	Roscas	Material	Pulg	mm	Pulg	mm	
1/4"	2FF1-B	1/8" - 27 NPTF	latón	1.91	48.6	0.93	23.5	3/4"
	2FBF1-B	1/8" - 28 BSPP	latón	1.91	48.6	0.93	23.5	3/4"
	2FF2	1/4" - 18 NPTF	acero	2.07	52.6	0.93	23.5	3/4"
	2FF2-B	1/4" - 18 NPTF	latón	2.07	52.6	0.93	23.5	3/4"
	2FF2-S	1/4" - 18 NPTF	A.I. 303	2.07	52.6	0.93	23.5	3/4"
	2FBF2-B	1/4" - 19 BSPP	latón	2.07	52.6	0.93	23.5	3/4"
	2FF3-B	3/8" - 18 NPTF	latón	2.10	53.4	0.93	23.5	13/16"
	2FF3-S	3/8" - 18 NPTF	A.I. 303	2.10	53.4	0.93	23.5	13/16"
3/8"	2FBF3-B	3/8" - 19 BSPP	latón	2.13	54.2	0.93	23.5	13/16"
	3FF2	1/4" - 18 NPTF	acero	2.41	61.2	1.13	28.6	7/8"
	3FF3	3/8" - 18 NPTF	acero	2.41	61.2	1.13	28.6	7/8"
	3FF3-S	3/8" - 18 NPTF	A.I. 303	2.41	61.2	1.13	28.6	7/8"
	3FBF3	3/8" - 19 BSPP	acero	2.42	61.5	1.13	28.6	7/8"
1/2"	3FF4	1/2" - 14 NPTF	acero	2.63	66.9	1.13	28.6	1"
	4FF3	3/8" - 18 NPTF	acero	2.85	72.5	1.24	31.4	1"
	4FF4	1/2" - 14 NPTF	acero	3.06	77.8	1.24	31.4	1"
	4FF4-S	1/2" - 14 NPTF	A.I. 303	3.06	77.8	1.24	31.4	1"
	4FBF4	1/2" - 14 BSPP	acero	3.09	78.4	1.24	31.4	1"
	4FF6	3/4" - 14 NPTF	acero	3.15	79.9	1.24	31.4	1-3/16"

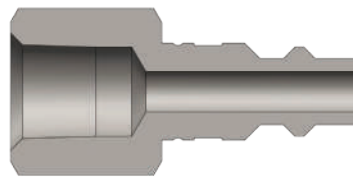

Serie-DF Niple Intercambio Industrial (Roscas Hembra)

Medida	Detalle			Medida		DE Máximo		Hex Pulg
	# de Parte	Roscas	Material	pulg	mm	pulg	mm	
1/4"	D2F1	1/8" - 27 NPTF	acero	1.44	36.6	0.65	16.5	9/16"
	D2F2	1/4" - 18 NPTF	acero	1.66	42.2	0.79	20.1	11/16"
	D2F2-B	1/4" - 18 NPTF	latón	1.66	42.2	0.79	20.1	11/16"
	D2F2-S	1/4" - 18 NPTF	A.I. 303	1.66	42.2	0.79	20.1	11/16"
	D2BF2	1/4" - 19 BSPP	acero	1.66	42.2	0.79	20.1	11/16"
	D2F3	3/8" - 18 NPTF	acero	1.66	42.2	1.01	25.7	7/8"
	D2F3-B	3/8" - 18 NPTF	latón	1.66	42.2	1.01	25.7	7/8"
	D2F3-S	3/8" - 18 NPTF	A.I. 303	1.66	42.2	1.01	25.7	7/8"
3/8"	D3F2	1/4" - 18 NPTF	acero	1.78	45.2	0.79	20.1	11/16"
	D3F3	3/8" - 18 NPTF	acero	1.78	45.2	1.01	25.7	7/8"
	D3F3-B	3/8" - 18 NPTF	latón	1.78	45.2	1.01	25.7	7/8"
	D3F3-S	3/8" - 18 NPTF	A.I. 303	1.78	45.2	1.01	25.7	7/8"
	D3BF3	3/8" - 19 BSPP	acero	1.78	45.2	1.01	25.7	7/8"
	D3F4	1/2" - 14 NPTF	acero	1.94	49.3	1.16	29.5	1"
1/2"	D4F3	3/8" - 18 NPTF	acero	2.10	53.3	1.01	25.7	7/8"
	D4F4	1/2" - 14 NPTF	acero	2.27	57.7	1.16	29.5	1"
	D4F4-B	1/2" - 14 NPTF	latón	2.27	57.7	1.16	29.5	1"
	D4F4-S	1/2" - 14 NPTF	A.I. 303	2.27	57.7	1.16	29.5	1"
	D4BF4	1/2" - 14 BSPP	acero	2.27	57.7	1.16	29.5	1"
	D4F6	3/4" - 14 NPTF	acero	2.30	58.4	1.37	34.8	1-3/16"
3/4"	D4F6-B	3/4" - 14 NPTF	latón	2.30	58.4	1.37	34.8	1-3/16"
	D6F4	1/2" - 14 NPTF	acero	2.22	56.4	1.52	38.6	1-5/16"
	D6F6	3/4" - 14 NPTF	acero	2.22	56.4	1.52	38.6	1-5/16"
	D6F8	1" - 11-1/2 NPTF	acero	2.41	61.2	1.80	45.7	1-9/16"

Perfil Neumático de Serie-DF

Medida	A	B
1/4"	0.32	0.21
3/8"	0.43	0.30
1/2"	0.56	0.38
3/4"	0.80	0.28

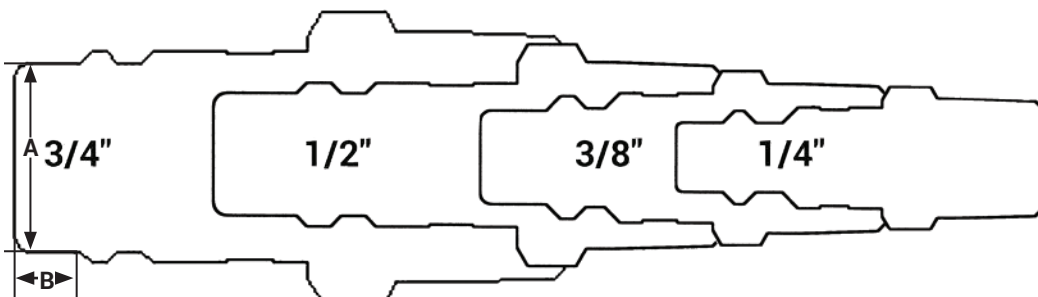

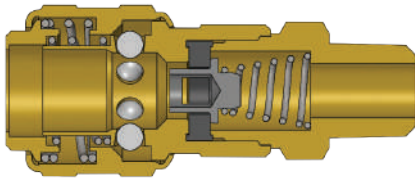

Medida	Serie-D Cople Intercambio Industrial Automático (Roscas Macho)							
	Detalle			Medida		DE Máximo		Hex Pulg
	# de Parte	Roscas	Material	pulg	mm	pulg	mm	
1/4"	2DM1-B	1/8" - 27 NPTF	latón	2.21	56.1	0.98	24.9	11/16"
	2DM2-B	1/4" - 18 NPTF	latón	2.34	59.4	0.98	24.9	11/16"
	2DM2-S	1/4" - 18 NPTF	A.I. 303	2.34	59.4	0.98	24.9	11/16"
	2DBM2-B	1/4" - 19 BSPT	latón	2.34	59.4	0.98	24.9	11/16"
	2DM3-B	3/8" - 18 NPTF	latón	2.36	59.9	0.98	24.9	11/16"
	2DM3-S	3/8" - 18 NPTF	A.I. 303	2.36	59.9	0.98	24.9	11/16"
	2DBM3-B	3/8" - 19 BSPT	latón	2.36	59.9	0.98	24.9	11/16"
3/8"	3DM2-B	1/4" - 18 NPTF	latón	2.59	65.8	1.18	30.0	7/8"
	3DM3-B	3/8" - 18 NPTF	latón	2.73	69.3	1.18	30.0	7/8"
	3DM3-S	3/8" - 18 NPTF	A.I. 303	2.73	69.3	1.18	30.0	7/8"
	3DBM3-B	3/8" - 19 BSPT	latón	2.73	69.3	1.18	30.0	7/8"
	3DM4-B	1/2" - 14 NPTF	latón	2.94	74.7	1.18	30.0	7/8"
1/2"	4DM3-B	3/8" - 18 NPTF	latón	3.13	79.5	1.34	34.0	1-1/16"
	4DM4-B	1/2" - 14 NPTF	latón	3.17	80.5	1.34	34.0	1-1/16"
	4DM4-S	1/2" - 14 NPTF	A.I. 303	3.17	80.5	1.34	34.0	1-1/16"
	4DBM4-B	1/2" - 14 BSPT	latón	3.17	80.5	1.34	34.0	1-1/16"
	4DM6-B	3/4" - 14 NPTF	latón	3.23	82.0	1.34	34.0	1-1/16"
3/4"	6DM4-B	1/2" - 14 NPTF	latón	2.95	74.9	1.90	48.3	1-3/16"
	6DM6-B	3/4" - 14 NPTF	latón	2.95	74.9	1.90	48.3	1-5/16"
	6DM8-B	1" - 11-1/2 NPTF	latón	3.12	79.2	1.90	48.3	1-9/16"

! Es importante estar seguro cuando se instalen las conexiones rápidas en circuitos neumáticos. Nunca instale acoples neumáticos directamente en la herramienta neumática. Utiliza una pieza de manguera que sea al menos 18" de largo entre la herramienta y el acople para prevenir daños al acople. Para proteger al operador, los dispositivos de seguridad como válvulas check y cables de seguridad deben estar instalados en caso de que haya una falla en la manguera o el acople.

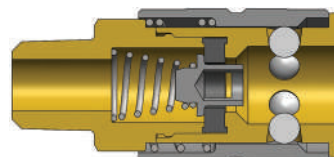
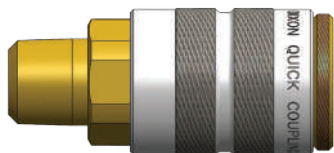

Medida	Serie-F Cople de Intercambio Industrial Manual (Roscas Macho)							
	Detalle			Medida		DE Máximo		Hex Pulg
	# de Parte	Roscas	Material	pulg	mm	pulg	mm	
1/4"	2FM1-B	1/8" - 27 NPTF	latón	1.97	50.0	0.88	22.4	3/4"
	2FM1-S	1/8" - 27 NPTF	A.I. 303	1.97	50.0	0.88	22.4	3/4"
	2FBM1-B	1/8" - 28 BSPT	latón	1.97	50.0	0.88	22.4	3/4"
	2FM2	1/4" - 18 NPTF	acero	2.04	51.8	0.88	22.4	3/4"
	2FM2-B	1/4" - 18 NPTF	latón	2.04	51.8	0.88	22.4	3/4"
	2FM2-S	1/4" - 18 NPTF	A.I. 303	2.04	51.8	0.88	22.4	3/4"
	2FBM2-B	1/4" - 19 BSPT	latón	2.04	51.8	0.88	22.4	3/4"
	2FM3-B	3/8" - 18 NPTF	latón	2.08	52.8	0.88	22.4	3/4"
	2FM3-S	3/8" - 18 NPTF	A.I. 303	2.08	52.8	0.88	22.4	3/4"
	2FBM3-B	3/8" - 19 BSPT	latón	2.08	52.8	0.88	22.4	3/4"
3/8"	3FM2	1/4" - 18 NPTF	acero	2.45	62.2	1.06	26.9	7/8"
	3FM3	3/8" - 18 NPTF	acero	2.46	62.5	1.06	26.9	7/8"
	3FM3-S	3/8" - 18 NPTF	A.I. 303	2.46	62.5	1.06	26.9	7/8"
	3FBM3	3/8" - 19 BSPT	acero	2.46	62.5	1.06	26.9	7/8"
	3FM4	1/2" - 14 NPTF	acero	2.55	64.8	1.06	26.9	7/8"
1/2"	4FM3	3/8" - 18 NPTF	acero	2.97	75.4	1.19	30.2	1"
	4FM4	1/2" - 14 NPTF	acero	3.07	78.0	1.19	30.2	1"
	4FM4-S	1/2" - 14 NPTF	A.I. 303	3.07	78.0	1.19	30.2	1"
	4FBM4	1/2" - 14 BSPT	acero	3.07	78.0	1.19	30.2	1"
	4FM6	3/4" - 14 NPTF	acero	3.12	79.2	1.19	30.2	1-1/16"

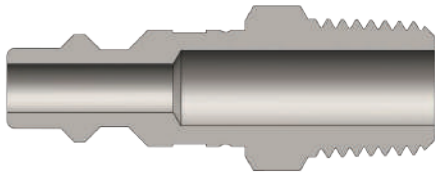

Medida	Serie-DF Niple Intercambio Industrial (Roscas Macho)							
	Detalle			Medida		DE Máximo		Hex Pulg
	# de Parte	Roscas	Material	pulg	mm	pulg	mm	
1/4"	D2M1	1/8" - 27 NPTF	acero	1.57	39.9	0.58	14.7	1/2"
	D2M1-B	1/8" - 27 NPTF	latón	1.57	39.9	0.58	14.7	1/2"
	D2M1-S	1/8" - 27 NPTF	A.I. 303	1.57	39.9	0.58	14.7	1/2"
	D2M2	1/4" - 18 NPTF	acero	1.69	42.9	0.65	16.5	9/16"
	D2M2-B	1/4" - 18 NPTF	latón	1.69	42.9	0.65	16.5	9/16"
	D2M2-S	1/4" - 18 NPTF	A.I. 303	1.69	42.9	0.65	16.5	9/16"
	D2BM2	1/4" - 19 BSPT	acero	1.69	42.9	0.65	16.5	9/16"
	D2M3	3/8" - 18 NPTF	acero	1.75	44.5	0.87	22.1	3/4"
	D2M3-B	3/8" - 18 NPTF	latón	1.75	44.5	0.87	22.1	3/4"
	D2M3-S	3/8" - 18 NPTF	A.I. 303	1.75	44.5	0.87	22.1	3/4"
3/8"	D3M2	1/4" - 18 NPTF	acero	1.81	46.0	0.79	20.1	11/16"
	D3M3	3/8" - 18 NPTF	acero	1.87	47.5	0.87	22.1	3/4"
	D3M3-B	3/8" - 18 NPTF	latón	1.87	47.5	0.87	22.1	3/4"
	D3M3-S	3/8" - 18 NPTF	A.I. 303	1.87	47.5	0.87	22.1	3/4"
	D3BM3	3/8" - 19 BSPT	acero	1.87	47.5	0.87	22.1	11/16"
	D3M4	1/2" - 14 NPTF	acero	2.03	51.6	1.01	25.7	7/8"
1/2"	D4M2	1/4" - 18 NPTF	acero	2.13	54.1	0.75	19.1	11/16"
	D4M3	3/8" - 18 NPTF	acero	2.19	55.6	0.87	22.1	3/4"
	D4M4	1/2" - 14 NPTF	acero	2.34	59.4	1.01	25.7	7/8"
	D4M4-B	1/2" - 14 NPTF	latón	2.34	59.4	1.01	25.7	7/8"
	D4M4-S	1/2" - 14 NPTF	A.I. 303	2.34	59.4	1.01	25.7	7/8"
	D4BM4	1/2" - 14 BSPT	acero	2.34	59.4	1.01	25.7	7/8"
	D4M6	3/4" - 14 NPTF	acero	2.50	63.5	1.23	31.2	1-1/16"
3/4"	D6M4	1/2" - 14 NPTF	acero	2.38	60.5	1.52	38.6	1-5/16"
	D6M6	3/4" - 14 NPTF	acero	2.38	60.5	1.52	38.6	1-5/16"
	D6M8	1" - 11-1/2 NPTF	acero	2.56	65.0	1.80	45.7	1-9/16"

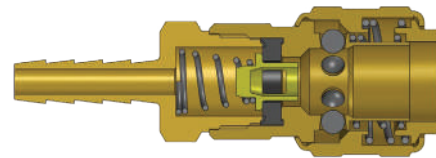

Serie-D Cople de Intercambio Industrial Automático (Barbas para Manguera)								
Medida	Detalle			Medida		DE Máximo		Hex Pulg
	# de Parte	DI Manguera	Material	pulg	mm	pulg	mm	
1/4"	2DS2-B	1/4"	latón	2.90	73.7	0.98	24.9	11/16"
	2DS2-S	1/4"	A.I. 303	2.90	73.7	0.98	24.9	11/16"
	2DS3-B	3/8"	latón	2.90	73.7	0.98	24.9	11/16"
	2DS3-S	3/8"	A.I. 303	2.90	73.7	0.98	24.9	11/16"
3/8"	3DS2-B	1/4"	latón	3.00	76.2	1.18	30.0	7/8"
	3DS3-B	3/8"	latón	3.00	76.2	1.18	30.0	7/8"
	3DS3-S	3/8"	A.I. 303	3.00	76.2	1.18	30.0	7/8"
	3DS4-B	1/2"	latón	3.00	76.2	1.18	30.0	7/8"
1/2"	4DS3-B	3/8"	latón	3.51	89.2	1.34	34.0	1-1/16"
	4DS4-B	1/2"	latón	3.51	89.2	1.34	34.0	1-1/16"
	4DS4-S	1/2"	A.I. 303	3.51	89.2	1.34	34.0	1-1/16"
	4DS6-B	3/4"	latón	3.51	89.2	1.34	34.0	1-1/16"
3/4"	6DS4-B	1/2"	latón	3.00	76.2	1.73	43.9	1-5/16"
	6DS6-B	3/4"	latón	3.00	76.2	1.73	43.9	1-5/16"
	6DS8-B	1"	latón	3.24	82.3	1.73	43.9	1-5/16"

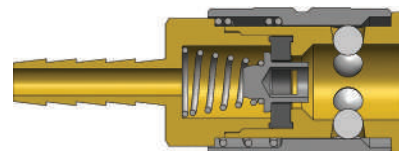
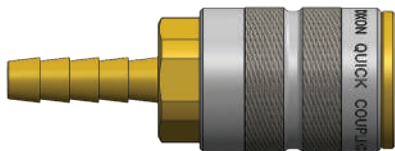

Serie-F Cople Intercambio Industrial Manual (Barbas para Manguera)								
Medida	Detalle			Medida		DE Máximo		Hex Pulg
	# de Parte	DI Manguera	Material	pulg	mm	pulg	mm	
1/4"	2FS2	1/4"	acero	2.53	64.3	0.88	22.4	3/4"
	2FS2-B	1/4"	latón	2.53	64.3	0.88	22.4	3/4"
	2FS2-S	1/4"	A.I. 303	2.53	64.3	0.88	22.4	3/4"
	2FS2.5-B	5/16"	latón	2.53	64.3	0.88	22.4	3/4"
	2FS3-B	3/8"	latón	2.53	64.3	0.88	22.4	3/4"
	2FS3-S	3/8"	A.I. 303	2.53	64.3	0.88	22.4	3/4"
3/8"	3FS2	1/4"	acero	2.86	72.6	1.06	26.9	7/8"
	3FS3	3/8"	acero	2.86	72.6	1.06	26.9	7/8"
	3FS3-S	3/8"	A.I. 303	2.86	72.6	1.06	26.9	7/8"
	3FS4	1/2"	acero	2.86	72.6	1.06	26.9	7/8"
1/2"	4FS3	3/8"	acero	3.49	88.6	1.19	30.2	1"
	4FS4	1/2"	acero	3.49	88.6	1.19	30.2	1"
	4FS4-S	1/2"	A.I. 303	3.49	88.6	1.19	30.2	1"
	4FS6	3/4"	acero	3.49	88.6	1.19	30.2	1"

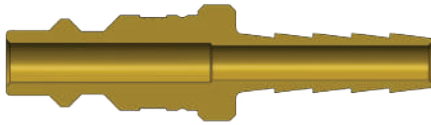

Medida	Serie-DF Niple de Intercambio Industrial (Barbas para Manguera)							
	Detalle			Medida		DE Máximo		Hex Pulg
	# de Parte	DI Manguera	Material	pulg	mm	pulg	mm	
1/4"	D2S2	1/4"	acero	2.09	53.1	0.56	14.2	-
	D2S2-B	1/4"	latón	2.09	53.1	0.56	14.2	-
	D2S2-S	1/4"	A.I. 303	2.09	53.1	0.56	14.2	-
	D2S2.5	5/16"	acero	2.09	53.1	0.56	14.2	-
	D2S3	3/8"	acero	2.09	53.1	0.56	14.2	-
	D2S3-B	3/8"	latón	2.09	53.1	0.56	14.2	-
	D2S3-S	3/8"	A.I. 303	2.09	53.1	0.56	14.2	-
3/8"	D3S2	1/4"	acero	2.21	56.1	0.75	19.1	-
	D3S3	3/8"	acero	2.21	56.1	0.75	19.1	-
	D3S3-B	3/8"	latón	2.21	56.1	0.75	19.1	-
	D3S3-S	3/8"	A.I. 303	2.21	56.1	0.75	19.1	-
	D3S4	1/2"	acero	2.21	56.1	0.75	19.1	-
1/2"	D4S3	3/8"	acero	2.53	64.3	0.75	19.1	-
	D4S3-B	3/8"	latón	2.53	64.3	0.75	19.1	-
	D4S4	1/2"	acero	2.53	64.3	0.75	19.1	-
	D4S4-B	1/2"	latón	2.53	64.3	0.75	19.1	-
	D4S4-S	1/2"	A.I. 303	2.53	64.3	0.75	19.1	-
	D4S6	3/4"	acero	2.53	64.3	0.94	23.9	-
	D4S6-B	3/4"	latón	2.53	64.3	0.94	23.9	-
3/4"	D6S4	1/2"	acero	3.49	88.7	1.52	38.6	-
	D6S6	3/4"	acero	3.49	88.7	1.52	38.6	-
	D6S8	1"	acero	3.49	88.7	1.52	38.6	-

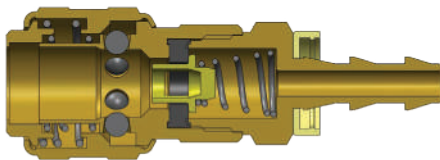

Medida	Serie-D Cople Intercambio Industrial Automático (Push-Loc)							
	Detalle			Medida		DE Máximo		Hex Pulg
	# de Parte	DI Manguera	Material	pulg	mm	pulg	mm	
1/4"	2DB2-B	1/4"	latón	2.76	70.1	0.98	24.9	11/16"
	2DB3-B	3/8"	latón	2.77	70.4	0.98	24.9	11/16"
3/8"	3DB3-B	3/8"	latón	2.82	71.7	1.18	30.0	7/8"
1/2"	4DB4-B	1/2"	latón	3.31	84.1	1.34	34.0	1-1/16"

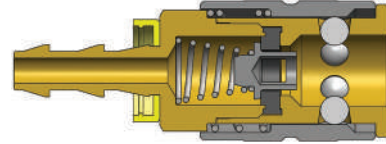
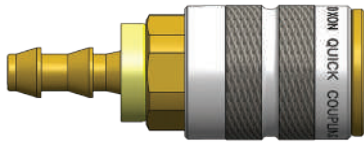

F-Series Manual Industrial Interchange Coupler (Push-Loc)

Medida	Detalle			Medida		DE Máximo		Hex Pulg
	# de Parte	DI Manguera	Material	pulg	mm	pulg	mm	
1/4"	2FB2-B	1/4"	latón	2.49	63.2	0.88	22.4	3/4"
	2FB3-B	3/8"	latón	2.49	63.2	0.88	22.4	3/4"
3/8"	3FB2	1/4"	acero	2.80	71.1	1.06	26.9	7/8"
	3FB3	3/8"	acero	2.80	71.1	1.06	26.9	7/8"
	3FB4	1/2"	acero	2.80	71.1	1.06	26.9	7/8"
1/2"	4FB3	3/8"	acero	3.40	86.4	1.19	30.2	1"
	4FB4	1/2"	acero	3.40	86.4	1.19	30.2	1"

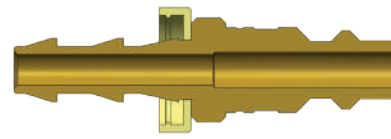

Serie-DF Niple Intercambio Industrial (Push-Loc)

Medida	Detalle			Medida		DE Máximo		Hex Pulg
	# de Parte	DI Manguera	Material	pulg	mm	pulg	mm	
1/4"	D2B2	1/4"	acero	2.09	53.1	0.69	17.5	-
	D2B2-B	1/4"	latón	2.09	53.1	0.69	17.5	-
	D2B3	3/8"	acero	2.09	53.1	0.86	21.8	-
3/8"	D3B2	1/4"	acero	2.21	56.1	0.75	19.1	-
	D3B3	3/8"	acero	2.21	56.1	0.75	19.1	-
	D3B4	1/2"	acero	2.35	59.7	0.75	19.1	-
1/2"	D4B4	1/2"	acero	2.67	67.8	0.75	19.1	-
3/4"	D6B6	3/4"	acero	2.99	75.9	1.00	25.4	-

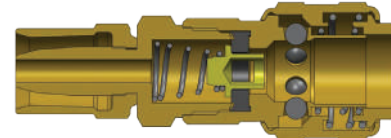

Serie-D Cople Intercambio Industrial Automático (Barbas Reutilizables)

Medida	Detalle			Medida		DE Máximo		Hex Pulg
	# de Parte	DI Manguera x OD	Material	pulg	mm	pulg	mm	
1/4"	2DE2-B	1/4" x 1/2"	latón	2.69	68.3	0.98	24.9	11/16"
	2DH2-B	1/4" x 5/8"	latón	2.79	70.9	0.98	24.9	11/16"
	2DK3-B	3/8" x 11/16"	latón	2.79	70.9	0.98	24.9	11/16"
	2DL3-B	3/8" x 3/4"	latón	2.85	72.4	0.98	24.9	11/16"

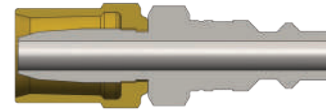

Serie-DF Niple Intercambio Industrial (Barbas Reutilizables)

Medida	Detalle			Medida		DE Máximo		Hex Pulg
	# de Parte	DI Manguera x OD	Material	pulg	mm	pulg	mm	
1/4"	D2E2	1/4" x 1/2"	acero	2.07	52.6	0.69	17.5	9/16"
	D2H2	1/4" x 5/8"	acero	2.16	54.9	0.81	20.6	9/16"
	D2K3	3/8" x 11/16"	acero	2.16	54.9	0.81	20.6	9/16"
	D2L3	3/8" x 3/4"	acero	2.18	55.4	0.95	24.1	9/16"

Operación Automática del Cople

Los acoples automáticos Serie-D han desempeñado su labor de manera segura y confiable por más de 50 años. Este increíble acople es una solución económica para conectar automáticamente líneas neumáticas presurizadas.

Cómo Desconectar

Empuja la manga hacia la punta.
No tires de la manga.

Empuja la manga hacia el niple.

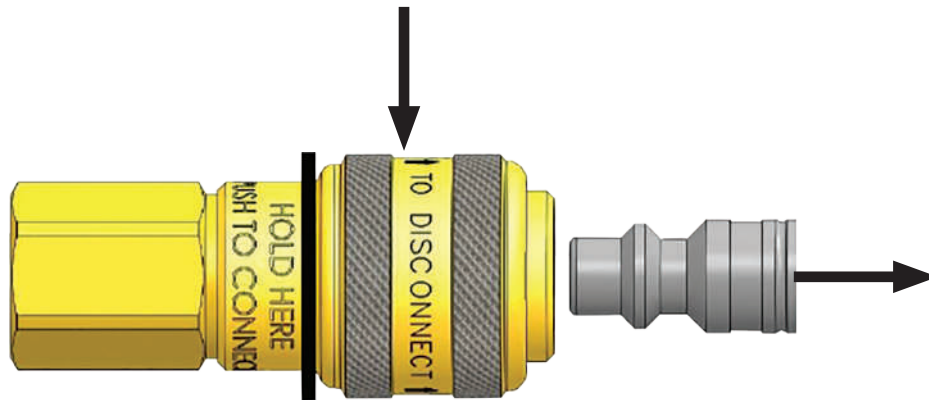

Cómo Conectar

Firmermente empuja el niple dentro del socket hasta que se escuche un click.
No tires de la manga.

Mantenlo aquí..
No lo mantengas después de la línea negra.

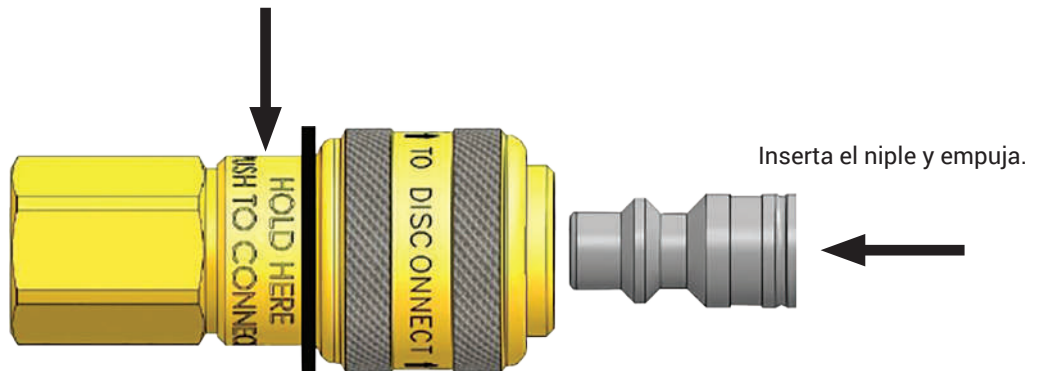

Coples Neumáticos: Serie-J

Información de Intercambio

- Intercambio automotriz estilo Tru-Flate
- Parker Serie-10
- Rectus 55KM

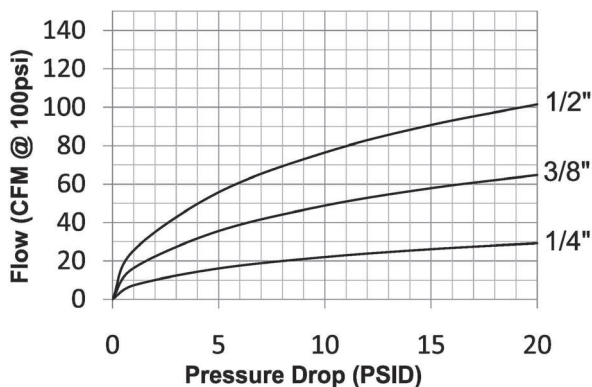

Materiales

- Los componentes son maquinados con barras sólidas de acero o latón.
- Los balines de acero inoxidable, anillos de retención y resortes maximizan la resistencia a la corrosión y extienden la vida de servicio.
- Los componentes de acero son platinados con cromo trivalente y cumplen con la norma ROHS.
- Los acoples manuales de 1/4" se construyen de latón con manga de acero y válvula tubular de acero como estándar.
- Coples manuales de 3/8" y 1/2" son construidos estándar con acero y válvula tubular de acero.

Componentes del Sello

- Sellos de Nitrilo (Buna-N) estándar brindan un rango de temperatura de -40°F a 250°F (-40°C a 121°C)

Tabla de Presión Nominal

Medida	Serie-J Intercambio Automotriz (Conectado)															
	Cople Latón/Niple Acero				Cople/Niple Latón				Cople/Niple Acero				Cople/Niple A.I. 303			
	Max. Trabajo		Reventón		Max. Trabajo		Reventón		Max. Trabajo		Reventón		Max. Trabajo		Reventón	
	PSI	Bar	PSI	Bar	PSI	Bar	PSI	Bar	PSI	Bar	PSI	Bar	PSI	Bar	PSI	Bar
1/4"	500	35	11,500	793	300	20	10,500	724	-	-	-	-	-	-	-	-
3/8"	-	-	-	-	-	-	-	-	500	35	18,000	1,241	-	-	-	-
1/2"	-	-	-	-	-	-	-	-	500	35	10,000	690	-	-	-	-

Especificaciones Técnicas

Medida	Estándar Intercambiable				Parámetros Funcionales					
	Ejército USA	Gobierno USA	Estándar Internacional	Estándares ANSI/NFPA	Cantidad de Balines	Inclusión de Aire	Pérdida de Flujo	Vacío	Flow ΔP = 15 PSI	
1/4"	-	-	-	-	6	N/A	N/A	N/R	26 CFM	
3/8"	-	-	-	-	6	N/A	N/A	N/R	58 CFM	
1/2"	-	-	-	-	6	N/A	N/A	N/A	91 CFM	

Opciones Disponibles

Medida	Opciones de Sello		Opciones de Válvula			Opciones de Manga				Treatments
	FKM	EPDM	Sin Válvula	Latón	Al 303	Bridado	Sleeve-Lock	Latón	Al 303	Oxy-Clean
	Pre	Pre	Suf	Suf	Suf	Suf	Suf	Suf	Suf	Suf
1/4"	F-	P-	-E	-BV	-SV	-FS	-LS	-BS	-XS	-C1
3/8"	F-	N/A	-E	-BV	-SV	N/A	-LS	N/A	-XS	-C1
1/2"	F-	N/A	-E	-BV	-SV	N/A	-LS	N/A	-XS	-C1

! La presión de operación para acoples que utilizan barbas de manguera en sus extremos puede reducirse drásticamente al valor de la manguera y/o la combinación de conexiones en los extremos. Consulte con el fabricante de la manguera para los valores de presión. Si tiene dudas, realice una prueba bajo condiciones controladas para comprobar la conexión. Dixon Quick Coupling no asume responsabilidad por una mala instalación que resulte en paros de producción, pérdidas y/o accidentes personales incluyendo la muerte.

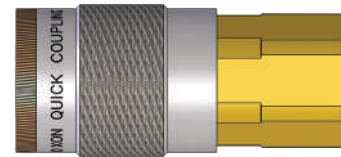
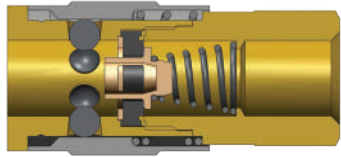

Medida	Serie-J Cople Intercambio Automotriz (Roscas Hembra)							
	Detalle			Medida		DE Máximo		Hex Pulg
	# de Parte	Roscas	Material	pulg	mm	pulg	mm	
1/4"	2JF1-B	1/8" - 27 NPTF	latón	1.83	46.5	0.88	22.4	3/4"
	2JF2-B	1/4" - 18 NPTF	latón	2.04	51.8	0.88	22.4	3/4"
	2JF3-B	3/8" - 18 NPTF	latón	2.14	54.4	0.88	22.4	13/16"
3/8"	3JF2	1/4" - 18 NPTF	acero	2.25	57.2	1.06	26.9	7/8"
	3JF3	3/8" - 18 NPTF	acero	2.48	63.0	1.06	26.9	7/8"
	3JF4	1/2" - 14 NPTF	acero	2.61	66.3	1.06	26.9	1"
1/2"	4FF3	3/8" - 18 NPTF	acero	2.85	72.5	1.24	31.4	1"
	4FF4	1/2" - 14 NPTF	acero	3.06	77.8	1.24	31.4	1"
	4FF6	3/4" - 14 NPTF	acero	3.15	79.9	1.24	31.4	1-3/16"

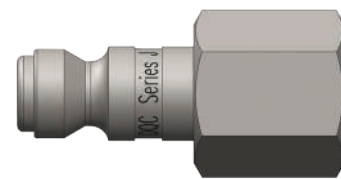
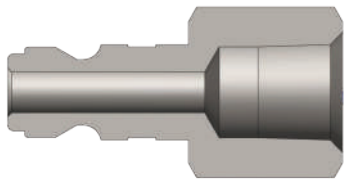

Medida	Serie-J Niple Intercambio Automotriz (Roscas Hembra)							
	Detalle			Medida		DE Máximo		Hex Pulg
	# de Parte	Roscas	Material	pulg	mm	pulg	mm	
1/4"	J2F1	1/8" - 27 NPTF	acero	1.34	34.0	0.65	16.5	9/16"
	J2F2	1/4" - 18 NPTF	acero	1.56	39.6	0.79	20.1	11/16"
	J2F2-B	1/4" - 18 NPTF	latón	1.56	39.6	0.79	20.1	11/16"
	J2F3	3/8" - 18 NPTF	acero	1.56	39.6	1.01	25.7	7/8"
3/8"	J3F2	1/4" - 18 NPTF	acero	1.75	44.5	0.79	20.1	11/16"
	J3F3	3/8" - 18 NPTF	acero	1.75	44.5	1.01	25.7	7/8"
	J3F4	1/2" - 14 NPTF	acero	1.91	48.5	1.16	29.5	1"
1/2"	J4F3	3/8" - 18 NPTF	acero	2.11	53.6	1.01	25.7	7/8"
	J4F4	1/2" - 14 NPTF	acero	2.26	57.4	1.16	29.5	1"
	J4F6	3/4" - 14 NPTF	acero	2.31	58.7	1.37	34.8	1-3/16"

Coples Neumáticos: Serie-J

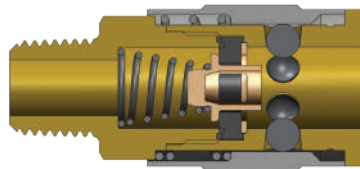
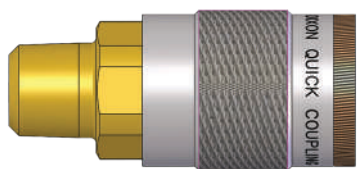

Serie-J Cople Intercambio Automotriz (Rosca Macho)

Medida	Serie-J Cople Intercambio Automotriz (Rosca Macho)							
	Detalle			Medida		DE Máximo		Hex Pulg
	# de Parte	Roscas	Material	pulg	mm	pulg	mm	
1/4"	2JM1-B	1/8" - 27 NPTF	latón	1.88	47.8	0.88	22.4	3/4"
	2JM2-B	1/4" - 18 NPTF	latón	2.05	52.0	0.88	22.4	3/4"
	2JM3-B	3/8" - 18 NPTF	latón	2.08	52.8	0.88	22.4	3/4"
3/8"	3JM2	1/4" - 18 NPTF	acero	2.45	62.2	1.06	26.9	7/8"
	3JM3	3/8" - 18 NPTF	acero	2.46	62.5	1.06	26.9	7/8"
	3JM4	1/2" - 14 NPTF	acero	2.55	64.8	1.06	26.9	7/8"
1/2"	4FM3	3/8" - 18 NPTF	acero	2.97	75.4	1.19	30.2	1"
	4FM4	1/2" - 14 NPTF	acero	3.07	78.0	1.19	30.2	1"
	4FM6	3/4" - 14 NPTF	acero	3.12	79.2	1.19	30.2	1-1/16"

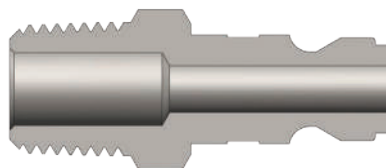

Serie-J Niple Intercambio Automotriz (Rosca Macho)

Medida	Serie-J Niple Intercambio Automotriz (Rosca Macho)							
	Detalle			Medida		DE Máximo		Hex Pulg
	# de Parte	Roscas	Material	pulg	mm	pulg	mm	
1/4"	J2M1	1/8" - 27 NPTF	acero	1.47	37.3	0.58	14.7	1/2"
	J2M2	1/4" - 18 NPTF	acero	1.59	40.4	0.65	16.5	9/16"
	J2M2-B	1/4" - 18 NPTF	latón	1.59	40.4	0.65	16.5	9/16"
	J2M3	3/8" - 18 NPTF	acero	1.65	41.9	0.79	20.1	3/4"
3/8"	J3M2	1/4" - 18 NPTF	acero	1.78	45.2	0.79	20.1	11/16"
	J3M3	3/8" - 18 NPTF	acero	1.84	46.7	0.79	20.1	3/4"
	J3M4	1/2" - 14 NPTF	acero	2.00	50.8	1.01	25.7	7/8"
1/2"	J4M3	3/8" - 18 NPTF	acero	2.20	55.9	0.79	20.1	11/16"
	J4M4	1/2" - 14 NPTF	acero	2.35	59.7	1.01	25.7	7/8"
	J4M6	3/4" - 14 NPTF	acero	2.51	63.8	1.23	31.2	1-1/16"

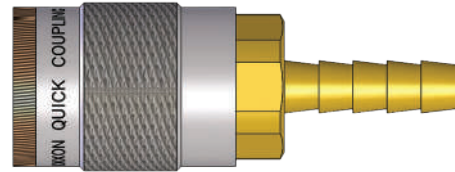
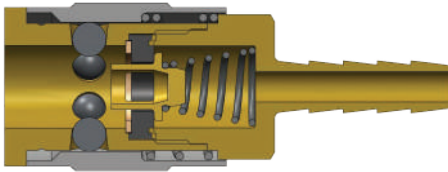

Medida	Serie-J Cople Intercambio Automotriz (Barbas para Manguera)							
	Detalle			Medida		DE Máximo		Hex Pulg
	# de Parte	DI Manguera	Material	pulg	mm	pulg	mm	
1/4"	2JS2-B	1/4"	latón	2.53	64.3	0.88	22.4	3/4"
	2JS3-B	3/8"	latón	2.53	64.3	0.88	22.4	3/4"
3/8"	3JS2	1/4"	acero	2.86	72.6	1.06	26.9	7/8"
	3JS3	3/8"	acero	2.86	72.6	1.06	26.9	7/8"
	3JS4	1/2"	acero	2.86	72.6	1.06	26.9	7/8"
1/2"	4FS3	3/8"	acero	3.49	88.6	1.19	30.2	1"
	4FS4	1/2"	acero	3.49	88.6	1.19	30.2	1"
	4FS6	3/4"	acero	3.49	88.6	1.19	30.2	1"

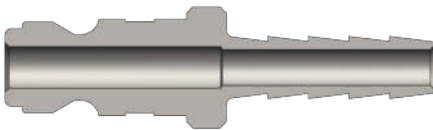

Medida	Serie-J Niple Intercambio Automotriz (Barbas para Manguera)							
	Detalle			Medida		DE Máximo		Hex Pulg
	# de Parte	DI Manguera	Material	pulg	mm	pulg	mm	
1/4"	J2S2	1/4"	acero	1.99	50.5	0.56	14.2	-
	J2S3	3/8"	acero	1.99	50.5	0.56	14.2	-
3/8"	J3S2	1/4"	acero	2.18	55.4	0.75	19.1	-
	J3S3	3/8"	acero	2.18	55.4	0.75	19.1	-
	J3S4	1/2"	acero	2.18	55.4	0.75	19.1	-
1/2"	J4S3	3/8"	acero	2.54	64.5	0.75	19.1	-
	J4S4	1/2"	acero	2.54	64.5	0.75	19.1	-
	J4S6	3/4"	acero	2.54	64.5	0.94	23.9	-

Coples Neumáticos: Serie-J

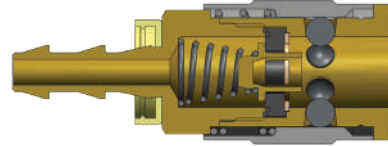
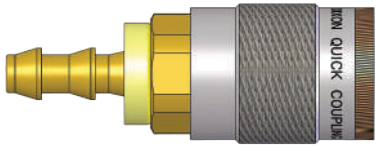

Medida	Serie-J Cople de Intercambio Automotriz (Push-Loc)							
	Detalle			Medida		DE Máximo		Hex Pulg
	# de Parte	DI Manguera	Material	pulg	mm	pulg	mm	
1/4"	2JB2-B	1/4"	latón	2.37	60.2	0.88	22.4	3/4"
	2JB3-B	3/8"	latón	2.49	63.2	0.88	22.4	3/4"
3/8"	3JB2	1/4"	acero	2.80	71.1	1.06	26.9	7/8"
	3JB3	3/8"	acero	2.80	71.1	1.06	26.9	7/8"
	3JB4	1/2"	acero	2.80	71.1	1.06	26.9	7/8"
1/2"	4FB3	3/8"	acero	3.40	86.4	1.19	30.2	1"
	4FB4	1/2"	acero	3.40	86.4	1.19	30.2	1"

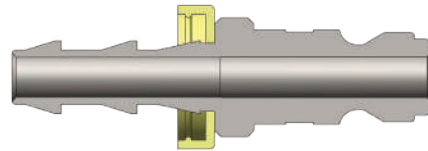
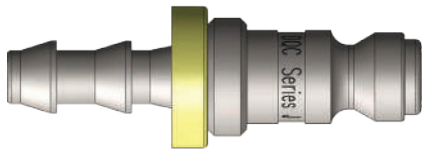

Medida	Serie-J Niple de Intercambio Automotriz (Push-Loc)							
	Detalle			Medida		DE Máximo		Hex Pulg
	# de Parte	DI Manguera	Material	pulg	mm	pulg	mm	
1/4"	J2B2	1/4"	acero	2.09	53.1	0.69	17.5	-
	J2B3	3/8"	acero	2.09	53.1	0.86	21.8	-
3/8"	J3B3	3/8"	acero	2.21	56.1	0.75	19.1	-
1/2"	J4B4	1/2"	acero	2.67	67.8	0.75	19.1	-

Perfil Serie-J

Medida	A	B
1/4"	0.42	0.06
3/8"	0.56	0.13
1/2"	0.65	0.13

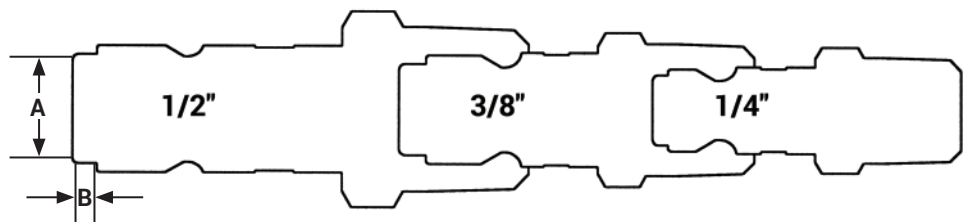

Interchange Data

- Intercambio ARO 210 (1/4") y ARO 310 (3/8")
- Acoples automáticos intercambio con ARO 210/310 y Hansen Serie 210/310
- Acoples manuales intercambio con Parker Serie 50 y Amflo tipo B

Materiales

- Los componentes son maquinados con barras sólidas de acero o latón.
- Resortes de acero inoxidable; balines, anillos de retención y pines de acero al carbón.
- Los componentes de acero son platinados con cromo trivalente y cumplen con la norma ROHS.
- Coples automáticos construidos de acero.
- Coples manuales construidos de latón.

Componentes del Sello

- Sellos de Nitrilo (Buna-N) estándar brindan un rango de temperatura de -40°F a 250°F (-40°C a 121°C)



Tabla de Presión Nominal

Medida	Serie-M Intercambio ARO (Conectado)															
	Auto Coupler/Acero Plug				Auto Coupler/Latón Plug				Manual Coupler/Acero Plug				Manual Coupler/Latón Plug			
	Max. Trabajo		Reventón		Max. Trabajo		Reventón		Max. Trabajo		Reventón		Max. Trabajo		Reventón	
	PSI	Bar	PSI	Bar	PSI	Bar	PSI	Bar	PSI	Bar	PSI	Bar	PSI	Bar	PSI	Bar
1/4"	300	20	2,600	179	300	20	5,000	345	300	20	12,400	855	300	20	12,700	876
3/8"	300	20	3,300	228	-	-	-	-	-	-	-	-	-	-	-	-

Especificaciones Técnicas

Medida	Estándar Intercambiable				Parámetros Funcionales				
	Ejército USA	Gobierno USA	Estándar Internacional	Estándares ANSI/NFPA	Mecanismo de Cierre	Inclusión de Aire	Pérdida de Flujo	Vacío	Flujo ΔP = 15 PSI
1/4"	-	-	-	-	Manual - 4 Bolas	N/A	N/A	N/R	25 CFM
	-	-	-	-	Auto - Pins	N/A	N/A	N/R	22 CFM
3/8"	-	-	-	-	Auto - Pins	N/A	N/A	N/R	42 CFM

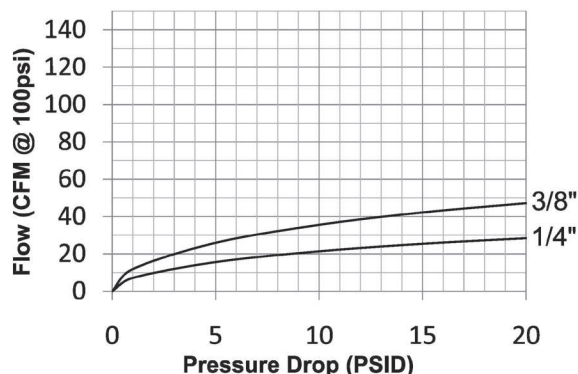
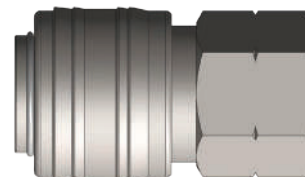
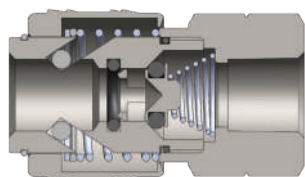

Medida	Serie-M Cople Intercambio ARO Automático (Roscas Hembra)							
	Detalle			Medida		DE Máximo		Hex Pulg
	# de Parte	Roscas	Material	pulg	mm	pulg	mm	
1/4"	2MF2-PL	1/4" - 18 NPT	acero/latón	1.72	43.6	1.06	27.0	13/16"
	2MF3-PL	3/8" - 18 NPT	acero/latón	1.72	43.6	1.06	27.0	13/16"
3/8"	3MF3-PL	3/8" - 18 NPT	acero/latón	1.93	49.0	1.26	32.0	1-1/16"

Coples Neumáticos: Serie-M

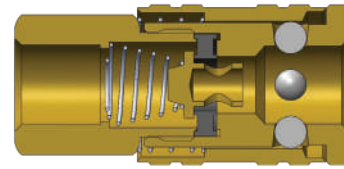
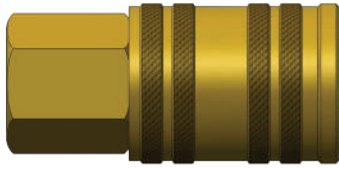

Serie-M Cople Intercambio ARO Manual (Roscas Hembra)

Medida	Detalle			Medida		DE Máximo		Hex Pulg
	# de Parte	Roscas	Material	pulg	mm	pulg	mm	
1/4"	2MF2-B	1/4" - 18 NPT	latón	1.97	50.0	0.87	22.0	3/4"
	2MF3-B	3/8" - 18 NPT	latón	2.05	52.0	0.87	22.0	13/16"

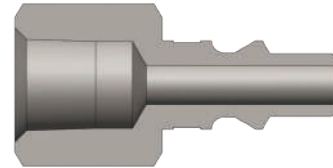

Serie-M Niple Intercambio ARO (Roscas Hembra)

Medida	Detalle			Medida		DE Máximo		Hex Pulg
	# de Parte	Roscas	Material	pulg	mm	pulg	mm	
1/4"	M2F2	1/4" - 18 NPTF	acero	1.57	39.9	0.79	20.1	11/16"
	M2F2-B	1/4" - 18 NPTF	latón	1.57	39.9	0.79	20.1	11/16"
	M2F3	3/8" - 18 NPTF	acero	1.57	39.9	1.01	25.7	7/8"
3/8"	M3F3	3/8" - 18 NPTF	acero	1.82	46.2	1.01	25.7	7/8"

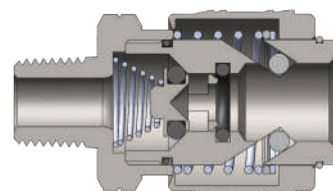
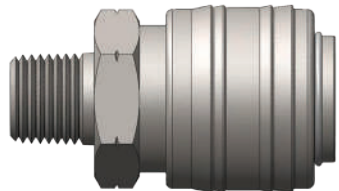

Serie-M Cople Intercambio ARO Automático (Roscas Macho)

Medida	Detalle			Medida		DE Máximo	
	# de Parte	Roscas	Material	pulg	mm	pulg	mm
1/4"	2MM2-PL	1/4" - 18 NPT	acero/latón	1.70	43.2	1.06	27.0
	2MM3-PL	3/8" - 18 NPT	acero/latón	1.80	45.6	1.06	27.0
3/8"	3MM3-PL	3/8" - 18 NPT	acero/latón	1.89	48.0	1.26	32.0
	3MM4-PL	1/2" - 14 NPTF	acero/latón	1.89	48.0	1.26	32.0

Perfil Serie-M

Medidas	A	B
1/4"	0.31	0.33
3/8"	0.43	0.59

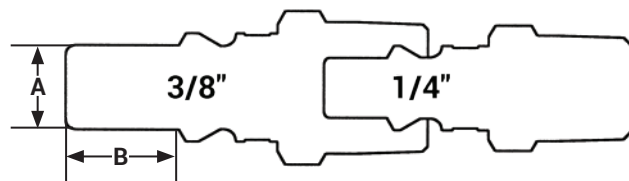

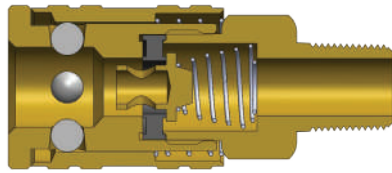

Medida	Serie-M Cople Intercambio ARO Manual (Rosca Macho)							
	Detalle			Medida		DE Máximo		Hex Pulg
	# de Parte	Roscas	Material	pulg	mm	pulg	mm	
1/4"	2MM2-B	1/4" - 18 NPT	latón	2.13	54.0	0.87	22.0	3/4"
	2MM3-B	3/8" - 18 NPT	latón	2.13	54.0	0.87	22.0	13/16"

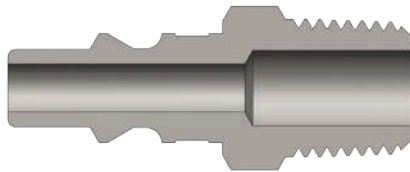

Medida	Serie-M Niple Intercambio ARO (Rosca Macho)							
	Detalle			Medida		DE Máximo		Hex Pulg
	# de Parte	Roscas	Material	pulg	mm	pulg	mm	
1/4"	M2M1	1/8" - 27 NPTF	acero	1.48	37.6	0.58	14.7	1/2"
	M2M2	1/4" - 18 NPTF	acero	1.60	40.6	0.65	16.5	9/16"
	M2M2-B	1/4" - 18 NPTF	latón	1.60	40.6	0.65	16.5	9/16"
	M2M3	3/8" - 18 NPTF	acero	1.80	45.7	0.79	20.1	3/4"
3/8"	M3M3	3/8" - 18 NPTF	acero	1.91	48.5	0.79	20.1	3/4"

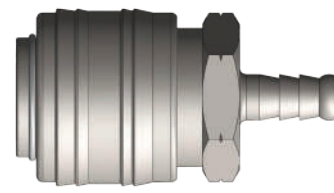
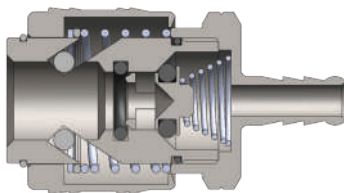

Medida	Serie-M Cople Intercambio ARO Automático (Barbas para Manguera)							
	Detalle			Medida		DE Máximo		Hex Pulg
	# de Parte	DI Manguera	Material	pulg	mm	pulg	mm	
1/4"	2MS2-PL	1/4"	acero/latón	1.91	48.6	1.06	27.0	13/16"
	2MS2.5-PL	5/16"	acero/latón	2.33	59.1	1.06	27.0	13/16"
	2MS3-PL	3/8"	acero/latón	2.50	63.6	1.06	27.0	13/16"
3/8"	3MS3-PL	3/8"	acero/latón	2.60	66.0	1.26	32.0	1-1/16"

Coples Neumáticos: Serie-M

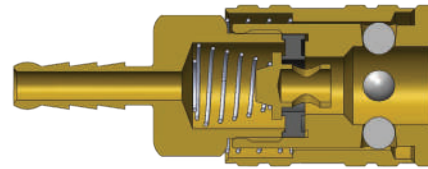
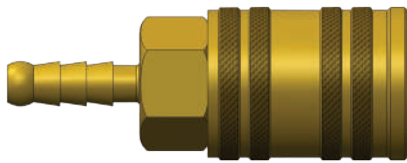

Serie-M Cople Intercambio ARO Manual (Barbas para Manguera)

Medida	Serie-M Cople Intercambio ARO Manual (Barbas para Manguera)							
	Detalle			Medida		DE Máximo		Hex Pulg
	# de Parte	DI Manguera	Material	Pulg	mm	Pulg	mm	
1/4"	2MS2-B	1/4"	latón	2.36	60.0	0.87	22.0	3/4"
	2MS3-B	3/8"	latón	2.76	70.0	0.87	22.0	13/16"

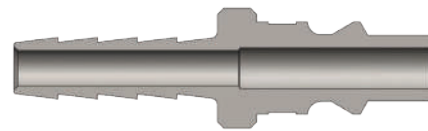

Serie-M Niple Intercambio ARO (Barbas para Manguera)

Medida	Serie-M Niple Intercambio ARO (Barbas para Manguera)							
	Detalle			Medida		DE Máximo		Hex Pulg
	# de Parte	DI Manguera	Material	Pulg	mm	Pulg	mm	
1/4"	M2S2	1/4"	acero	2.00	50.8	0.56	14.2	-
	M2S3	3/8"	acero	2.00	50.8	0.56	14.2	-
3/8"	M3S3	3/8"	acero	2.25	57.2	0.88	22.4	-

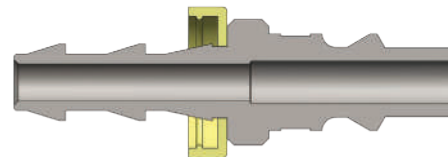

Serie-M Niple Intercambio ARO (Push-Loc)

Medida	Serie-M Niple Intercambio ARO (Push-Loc)							
	Detalle			Medida		DE Máximo		Hex Pulg
	# de Parte	DI Manguera	Material	Pulg	mm	Pulg	mm	
1/4"	M2B2	1/4"	acero	2.09	53.1	0.69	17.5	-

! La presión de operación para acoples que utilizan barbas de manguera en sus extremos puede reducirse drásticamente al valor de la manguera y/o la combinación de conexiones en los extremos. Consulte con el fabricante de la manguera para los valores de presión. Si tiene dudas, realice una prueba bajo condiciones controladas para comprobar la conexión. Dixon Quick Coupling no asume responsabilidad por una mala instalación que resulte en paros de producción, pérdidas y/o accidentes personales incluyendo la muerte.

Información de Intercambio

- Intercambio Europeo High-flow
- 1/4" se intercambia con Coilhose Megaflow, CEJN 320 y Rectus 25KA/26KA
- 3/8" se intercambia con Rectus 27KA y CEJN 410

Componentes del Sello

- Sellos de nitrilo (Buna-N) energizados neumáticamente son Estándar, brinda un rango de temperatura de **-40°F a 250°F** (-40°C a 121°C)

Materiales

- Los componentes son maquinados con barras sólidas de acero o latón.
- Balines, anillos de retención y resortes de acero inoxidable
- Los componentes de acero son platinados con cromo trivalente y cumplen con la norma ROHS



Tabla de Presión Nominal

Medida	Serie-CJ Intercambio Europeo Flujo Alto (Conectado)							
	Cople Latón/Niple Acero				Cople/Niple Latón			
	Trabajo Máximo		Reventón		Trabajo Máximo		Reventón	
	PSI	Bar	PSI	Bar	PSI	Bar	PSI	Bar
1/4"	300	20	9,500	655	300	20	7,200	500
3/8"	300	20	8,000	552	300	20	4,400	300

Especificaciones Técnicas

Medida	Estándar Intercambiable				Parámetros Funcionales				
	Ejército USA	Gobierno USA	Estándar Internacional	Estándares ANSI/NFPA	Cantidad Balines	Inclusión de Aire	Pérdida de Flujo	Vacío	Flujo ΔP = 15 PSI
1/4"	-	-	-	-	6	N/A	N/A	N/R	37 CFM
3/8"	-	-	-	-	6	N/A	N/A	N/R	67 CFM

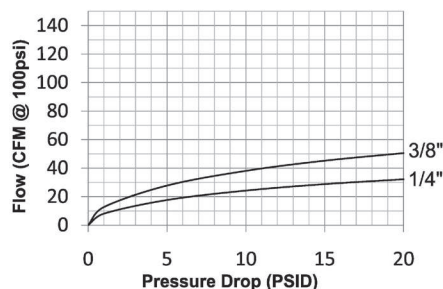
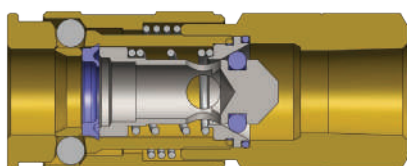

Medida	Serie-CJ Cople Intercambio Europeo (Roscas Hembra)							
	Detalle			Medida		DE Máximo		Hex Pulg
	# de Parte	Roscas	Material	Pulg	mm	Pulg	mm	
1/4"	2CJF2-B	1/4" - 18 NPT	latón	2.32	59.0	0.92	23.4	3/4"
	2CJBF2-B	1/4" - 19 BSPP	latón	2.32	59.0	0.92	23.4	3/4"
	2CJF3-B	3/8" - 18 NPT	latón	2.32	59.0	0.92	23.4	3/4"
	2CJBF3-B	3/8" - 19 BSPP	latón	2.32	59.0	0.92	23.4	3/4"
3/8"	3CJF3-B	3/8" - 18 NPT	latón	2.54	64.5	1.09	27.7	15/16"
	3CJBF3-B	3/8" - 19 BSPP	latón	2.54	64.5	1.09	27.7	15/16"
	3CJF4-B	1/2" - 14 NPT	latón	2.68	68.0	1.09	27.7	15/16"
	3CJBF4-B	1/2" - 14 BSPP	latón	2.68	68.0	1.09	27.7	15/16"

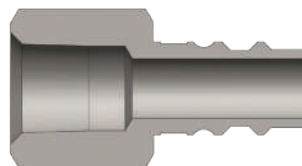

Serie-CJ Niple Intercambio Europeo (Roscas Hembra)

Medida	Detalle			Medida		DE Máximo		Hex Pulg
	# de Parte	Roscas	Material	pulg	mm	pulg	mm	
1/4"	CJ2F2-LG	1/4" - 18 NPT	acero	1.42	36.0	0.79	20.1	11/16"
	CJ2F2-B	1/4" - 18 NPT	latón	1.42	36.0	0.79	20.1	11/16"
	CJ2BF2-LG	1/4" - 19 BSPP	acero	1.42	36.0	0.79	20.1	11/16"
	CJ2BF2-B	1/4" - 19 BSPP	latón	1.42	36.0	0.79	20.1	11/16"
	CJ2F3-LG	3/8" - 18 NPT	acero	1.48	37.5	1.01	25.7	7/8"
	CJ2F3-B	3/8" - 18 NPT	latón	1.48	37.5	1.01	25.7	7/8"
	CJ2BF3-LG	3/8" - 19 BSPP	acero	1.48	37.5	1.01	25.7	7/8"
	CJ2BF3-B	3/8" - 19 BSPP	latón	1.48	37.5	1.01	25.7	7/8"
3/8"	CJ3F3	3/8" - 18 NPT	acero	1.50	38.0	1.01	25.7	7/8"
	CJ3F3-B	3/8" - 18 NPT	latón	1.50	38.0	1.01	25.7	7/8"
	CJ3BF3	3/8" - 19 BSPP	acero	1.50	38.0	1.01	25.7	7/8"
	CJ3BF3-B	3/8" - 19 BSPP	latón	1.50	38.0	1.01	25.7	7/8"
	CJ3F4	1/2" - 14 NPT	acero	1.71	43.5	1.16	29.5	1"
	CJ3F4-B	1/2" - 14 NPT	latón	1.71	43.5	1.16	29.5	1"
	CJ3BF4	1/2" - 14 BSPP	acero	1.71	43.5	1.16	29.5	1"
	CJ3BF4-B	1/2" - 14 BSPP	latón	1.71	43.5	1.16	29.5	1"

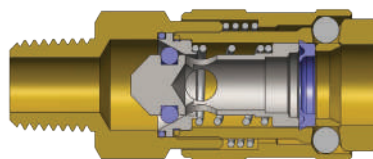
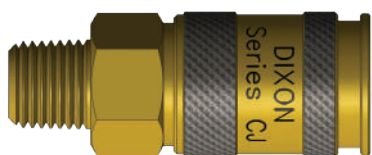

Serie-CJ Cople Intercambio Europeo (Rosca Macho)

Medida	Detalle			Medida		DE Máximo		Hex Pulg
	# de Parte	Roscas	Material	pulg	mm	pulg	mm	
1/4"	2CJM2-B	1/4" - 18 NPT	latón	2.44	62.0	0.92	23.4	3/4"
	2CJBM2-B	1/4" - 19 BSPT	latón	2.44	62.0	0.92	23.4	3/4"
	2CJM3-B	3/8" - 18 NPT	latón	2.44	62.0	0.92	23.4	3/4"
	2CJBM3-B	3/8" - 19 BSPT	latón	2.44	62.0	0.92	23.4	3/4"
3/8"	3CJM3-B	3/8" - 18 NPT	latón	2.64	67.0	1.09	27.7	15/16"
	3CJBM3-B	3/8" - 19 BSPT	latón	2.64	67.0	1.09	27.7	15/16"
	3CJM4-B	1/2" - 14 NPT	latón	2.76	70.0	1.09	27.7	15/16"
	3CJBM4-B	1/2" - 14 BSPT	latón	2.76	70.0	1.09	27.7	15/16"

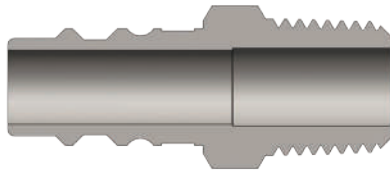

Medida	Serie-CJ Niple de Intercambio Europeo (Roscas Macho)							
	Detalle			Medida		DE Máximo		Hex Pulg
	# de Parte	Roscas	Material	pulg	mm	pulg	mm	
1/4"	CJ2M2-LG	1/4" - 18 NPT	acero	1.48	37.5	0.65	16.5	9/16"
	CJ2M2-B	1/4" - 18 NPT	latón	1.48	37.5	0.65	16.5	9/16"
	CJ2BM2-LG	1/4" - 19 BSPT	acero	1.48	37.5	0.65	16.5	9/16"
	CJ2BM2-B	1/4" - 19 BSPT	latón	1.48	37.5	0.65	16.5	9/16"
	CJ2M3-LG	3/8" - 18 NPT	acero	1.56	39.5	0.79	20.1	11/16"
	CJ2M3-B	3/8" - 18 NPT	latón	1.56	39.5	0.79	20.1	11/16"
	CJ2BM3-LG	3/8" - 19 BSPT	acero	1.56	39.5	0.79	20.1	11/16"
	CJ2BM3-B	3/8" - 19 BSPT	latón	1.56	39.5	0.79	20.1	11/16"
3/8"	CJ3M3	3/8" - 18 NPT	acero	1.57	40.0	0.79	20.1	11/16"
	CJ3M3-B	3/8" - 18 NPT	latón	1.57	40.0	0.79	20.1	11/16"
	CJ3BM3	3/8" - 19 BSPT	acero	1.57	40.0	0.79	20.1	11/16"
	CJ3BM3-B	3/8" - 19 BSPT	latón	1.57	40.0	0.79	20.1	11/16"
	CJ3M4	1/2" - 14 NPT	acero	1.81	46.0	1.01	25.7	7/8"
	CJ3M4-B	1/2" - 14 NPT	latón	1.81	46.0	1.01	25.7	7/8"
	CJ3BM4	1/2" - 14 BSPT	acero	1.81	46.0	1.01	25.7	7/8"
	CJ3BM4-B	1/2" - 14 BSPT	latón	1.81	46.0	1.01	25.7	7/8"

Perfil Serie-CJ

Medida	A	B
1/4"	0.39	0.19
3/8"	0.51	0.81

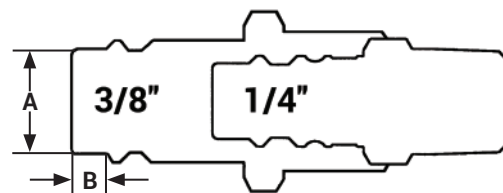

Coples Neumáticos: Serie-SHD

Información de Intercambio

- Intercambio con Schrader Twist-Lock
- Parker Twist-Lock, Foster SHD

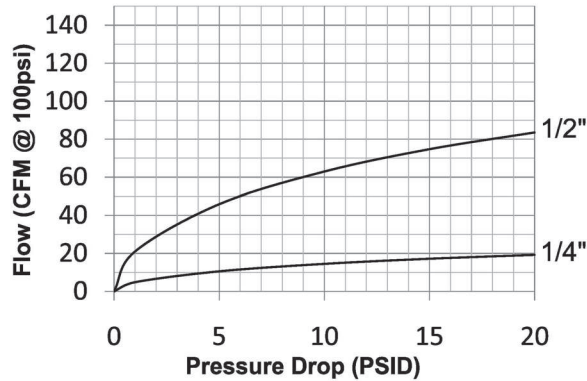

Materiales

- Los componentes son maquinados con barras sólidas de acero, latón o aluminio.
- Resortes y trinquetes de acero inoxidable. Anillos de retención de acero al carbón.
- Los componentes de acero son platinados con cromo trivalente y cumplen con la norma ROHS
- Los componentes del adaptador son construidos de latón
- Las mangas son de acero

Componentes del Sello

- Sellos de Nitrilo (Buna-N) estándar brindan un rango de temperatura de -40°F a 250°F (-40°C a 121°C)

Tabla de Presión Nominal

Medida	Serie-SHD Intercambio Twist-Lock (Conectado)			
	Cople/Niple Acero			
	Trabajo Máximo		Reventón	
	PSI	Bar	PSI	Bar
1/4"	300	20	6,500	448
1/2"	300	20	13,400	924

Especificaciones Técnicas

Medida	Estándar Intercambiable				Parámetros Funcionales				
	Ejército USA	Gobierno USA	Estándar Internacional	Estándares ANSI/NFPA	Mecanismo Seguridad	Inclusión de Aire	Pérdida de Flujo	Vacío	Flujo ΔP = 15 PSI
1/4"	-	-	-	-	Trinquetes	N/A	N/A	N/R	17 CFM
1/2"	-	-	-	-	Trinquetes	N/A	N/A	N/R	75 CFM

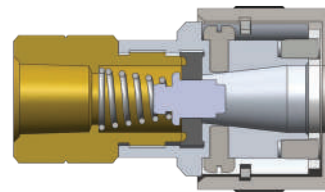

Serie-SHD Cople Intercambio Twist-Lock (Roscas Hembra)

Medida	Detalle			Medida		DE Máximo		Hex Pulg
	# de Parte	Roscas	Material	pulg	mm	pulg	mm	
1/4"	2SHDF2	1/4" - 18 NPT	aluminio	2.10	53.3	1.12	28.4	11/16"
	2SHDF3	3/8" - 18 NPT	aluminio	2.18	55.4	1.12	28.4	11/16"
1/2"	4SHDF3	3/8" - 18 NPT	aluminio	2.59	65.8	1.50	38.1	1-1/8"
	4SHDF4	1/2" - 14 NPT	aluminio	2.66	67.6	1.50	38.1	1-1/8"
	4SHDF6	3/4" - 14 NPT	aluminio	2.81	71.4	1.50	38.1	1-1/8"

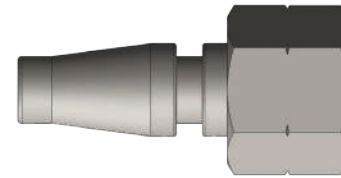
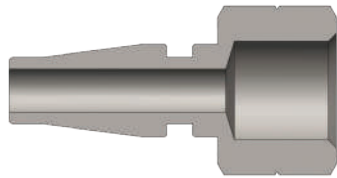

Medida	Serie-SHD Niple Intercambio Twist-Lock (Roscas Hembra)							
	Detalle			Medida		DE Máximo		Hex Pulg
	# de Parte	Roscas	Material	pulg	mm	pulg	mm	
1/4"	SHD2F1	1/8" - 27 NPT	acero	1.49	37.9	0.79	20.1	11/16"
	SHD2F2	1/4" - 18 NPT	acero	1.62	41.2	0.79	20.1	11/16"
1/2"	SHD4F3	3/8" - 18 NPT	acero	1.79	45.5	1.01	25.7	7/8"

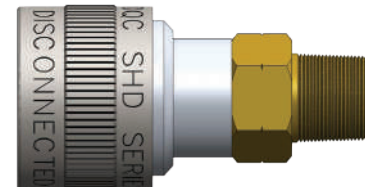
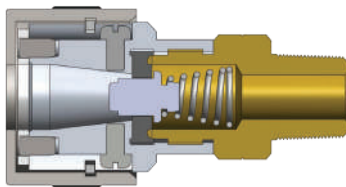

Medida	Serie-SHD Cople Intercambio Twist-Lock (Roscas Macho)							
	Detalle			Medida		DE Máximo		Hex Pulg
	# de Parte	Roscas	Material	pulg	mm	pulg	mm	
1/4"	2SHDM2	1/4" - 18 NPT	aluminio	2.22	56.4	1.12	28.4	11/16"
	2SHDM3	3/8" - 18 NPT	aluminio	2.28	57.9	1.12	28.4	11/16"
1/2"	4SHDM3	3/8" - 18 NPT	aluminio	2.55	64.8	1.50	38.1	1-1/8"
	4SHDM4	1/2" - 14 NPT	aluminio	2.61	66.3	1.50	38.1	1-1/8"

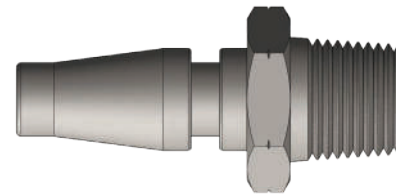
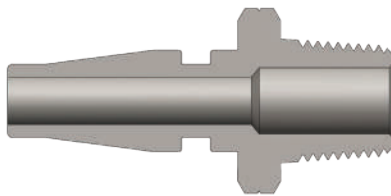

Medida	Serie-SHD Niple Intercambio Twist-Lock (Roscas Macho)							
	Detalle			Medida		DE Máximo		Hex Pulg
	# de Parte	Roscas	Material	pulg	mm	pulg	mm	
1/4"	SHD2M1	1/8" - 27 NPT	acero	1.54	39.1	0.79	20.1	11/16"
	SHD2M2	1/4" - 18 NPT	acero	1.72	43.7	0.79	20.1	11/16"
1/2"	SHD4M3	3/8" - 18 NPT	acero	1.81	46.0	1.01	25.7	7/8"
	SHD4M4	1/2" - 14 NPT	acero	1.87	47.5	1.01	25.7	7/8"

Coples Neumáticos: Serie-SHD

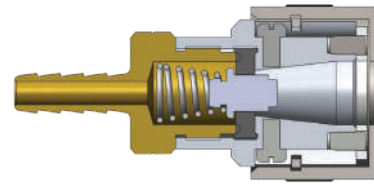
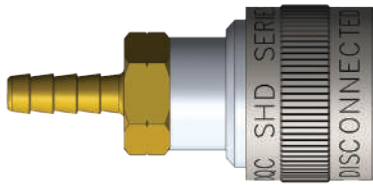

Medida	Serie-SHD Cople Intercambio Twist-Lock (Barbas para Manguera)							
	Detalle			Medida		DE Máximo		Hex Pulg
	# de Parte	DI Manguera	Material	Pulg	mm	Pulg	mm	
1/4"	2SHDS2	1/4"	aluminio	2.54	64.5	1.12	28.4	11/16"
	2SHDS3	3/8"	aluminio	2.67	67.8	1.12	28.4	11/16"
1/2"	4SHDS3	3/8"	aluminio	2.99	76.0	1.50	38.1	1-1/8"
	4SHDS4	1/2"	aluminio	4.23	107.4	1.50	38.1	1-1/8"

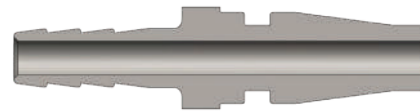
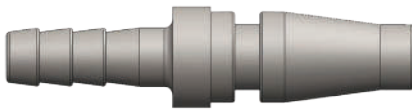

Medida	Serie-SHD Niple Intercambio Twist-Lock (Barbas para Manguera)							
	Detalle			Medida		DE Máximo		Hex Pulg
	# de Parte	DI Manguera	Material	Pulg	mm	Pulg	mm	
1/4"	SHD2S2	1/4"	acero	2.03	51.6	0.65	16.5	-
	SHD2S3	3/8"	acero	2.22	56.4	0.65	16.5	-
1/2"	SHD4S3	3/8"	acero	2.34	59.4	0.80	20.3	-
	SHD4S4	1/2"	acero	2.53	64.3	0.80	20.3	-

Perfil Serie SHD

Medida	A	B
1/4"	0.32	0.75
3/8"	0.50	0.75

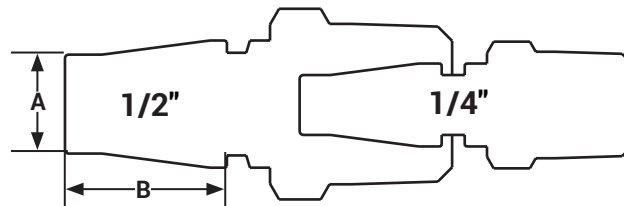

! La presión de operación para acoples que utilizan barbas de manguera en sus extremos puede reducirse drásticamente al valor de la manguera y/o la combinación de conexiones en los extremos. Consulte con el fabricante de la manguera para los valores de presión. Si tiene dudas, realice una prueba bajo condiciones controladas para comprobar la conexión. Dixon Quick Coupling no asume responsabilidad por una mala instalación que resulte en paros de producción, pérdidas y/o accidentes personales incluyendo la muerte.

Información de Intercambio

- Intercambio Automotriz Lincoln Nariz Larga
- Parker Serie-70, Coilhose Tipo-17

Materiales

- Los componentes son maquinados con barras sólidas de acero o latón.
- Resortes de acero inoxidable, balines y anillo de retención de acero al carbón.
- Los componentes de acero son platinados con cromo trivalente y cumplen con la norma ROHS.

Componentes de Sellos

- Sellos de Nitrilo (Buna-N) estándar brindan un rango de temperatura de -40°F a 250°F (-40°C a 121°C)



Tabla de Presión Nominal

Medida	Serie-L Intercambio Lincoln (Conectado)			
	Cople Latón/Niple Acero			
	Trabajo Máximo		Reventón	
	PSI	Bar	PSI	Bar
1/4"	300	21	5,000	345

Especificaciones Técnicas

Medida	Estándar Intercambiable				Parámetros Funcionales				
	Ejército USA	Gobierno USA	Estándar Internacional	Estándares ANSI/NFPA	Cantidad Balines	Inclusión de Aire	Pérdida de Flujo	Vacío	Flujo ΔP = 15 PSI
1/4"	-	-	-	-	4	N/A	N/A	N/R	21 CFM

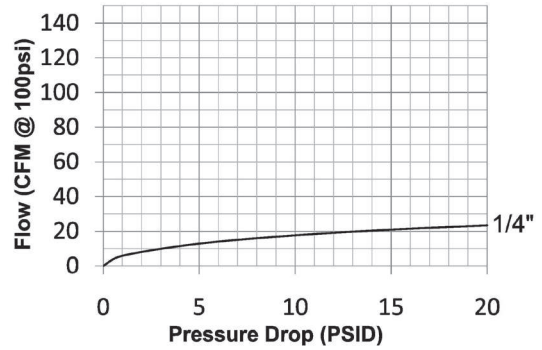
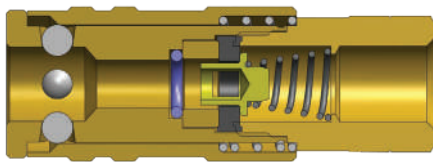

Serie-L Cople Intercambio Lincoln (Roscas Hembra)

Medida	Serie-L Cople Intercambio Lincoln (Roscas Hembra)							
	Detalle			Medida		DE Máximo		Hex Pulg
	# de Parte	Roscas	Material	Pulg	mm	Pulg	mm	
1/4"	2LF2-B	1/4" - 18 NPT	latón	2.40	61.0	0.90	22.9	3/4"

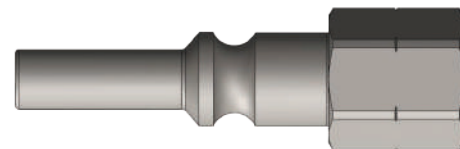
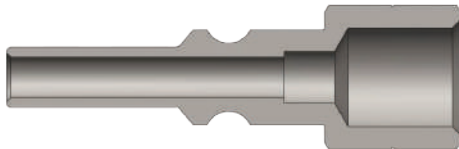

Serie-L Niple Intercambio Lincoln (Roscas Hembra)

Medida	Serie-L Niple Intercambio Lincoln (Roscas Hembra)							
	Detalle			Medida		DE Máximo		Hex Pulg
	# de Parte	Roscas	Material	Pulg	mm	Pulg	mm	
1/4"	L2F2	1/4" - 18 NPT	acero	2.10	53.3	0.72	18.3	5/8"

Coples Neumáticos: Serie-L

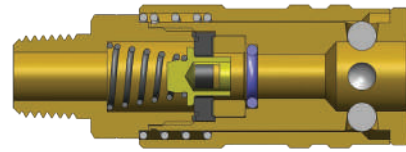

Serie-L Cople Intercambio Lincoln (Roscas Macho)

Medida	Detalle			Medida		DE Máximo		Hex Pulg
	# de Parte	Roscas	Material	Pulg	mm	Pulg	mm	
1/4"	2LM2-B	1/4" - 18 NPT	latón	2.62	66.5	0.90	22.9	3/4"

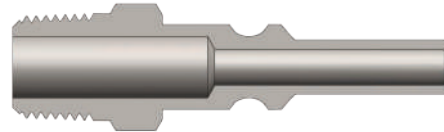
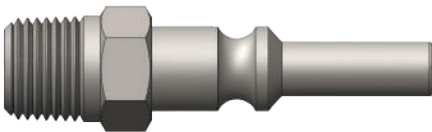

Serie-L Niple Intercambio Lincoln (Roscas Macho)

Medida	Detalle			Medida		DE Máximo		Hex Pulg
	# de Parte	Roscas	Material	Pulg	mm	Pulg	mm	
1/4"	L2M2	1/4" - 18 NPT	acero	2.25	57.2	0.65	16.5	9/16"

Perfil Serie-L

Medida	A	B
3/8"	0.28	0.79

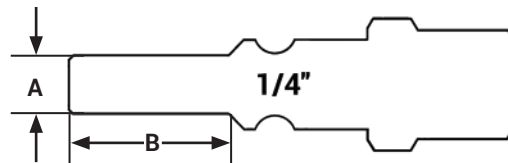

! La seguridad es de suma importancia cuando instala acoples rápidos en un circuito hidráulico. Nunca instale acoples neumáticos directamente en la herramienta neumática. Utiliza una pieza de manguera que sea por lo menos 18" entre la herramienta y el acople para prevenir de daños el acople. Para proteger al operador, utilizar dispositivos de seguridad como válvulas check e instalar cables de seguridad en caso de que falle el acople o la manguera.

Información de Intercambio

- Serie-2U 6-en-1 (ARO 210, Industrial, Tru-Flate, Lincoln, Italian, y CEJN 320)
- Serie-3U 4-en-1 (ARO 310, Industrial, Tru-Flate, y CEJN 410)
- Parker Serie-UC, Hansen Auto-Flo 23, y Coilhose Serie UC

Materiales

- Los componentes son maquinados con barras sólidas de latón.
- Resortes de acero inoxidable, balines y anillo de retención de acero al carbón.
- Valve components are machined from solid latón bar stock Los componentes de la válvula son maquinados con barras de latón sólido.

Componentes de Sellos

- Sellos de nitrilo (Buna-N) energizados neumáticamente son estándar, brinda un rango de temperatura de -40°F a 250°F (-40°C a 121°C)



Tabla de Presión Nominal

Medida	Serie-U Cople Universal Automático Conectado															
	Cople/Niple DF Acero				Cople/Niple CJ Acero				Cople/Niple J Acero				Cople/Niple M Acero			
	Max. Trabajo		Reventón		Max. Trabajo		Reventón		Max. Trabajo		Reventón		Max. Trabajo		Reventón	
	PSI	Bar	PSI	Bar	PSI	Bar	PSI	Bar	PSI	Bar	PSI	Bar	PSI	Bar	PSI	Bar
1/4"	300	20	2,800	193	300	20	9,500	655	300	20	6,400	441	300	20	4,300	297
3/8"	300	20	2,000	138	300	20	8,000	552	300	20	4,000	276	300	20	2,000	138

Especificaciones Técnicas

Medida	Estándar Intercambiable				Parámetros Funcionales				
	Ejército USA	Gobierno USA	Estándar Internacional	Estándares ANSI/NFPA	Cantidad Balines	Inclusión de Aire	Pérdida de Flujo	Vacío	Flujo ΔP = 15 PSI
1/4"	-	-	-	-	6	N/A	N/A	N/R	37 SCFM
3/8"	-	-	-	-	6	N/A	N/A	N/R	67 SCFM

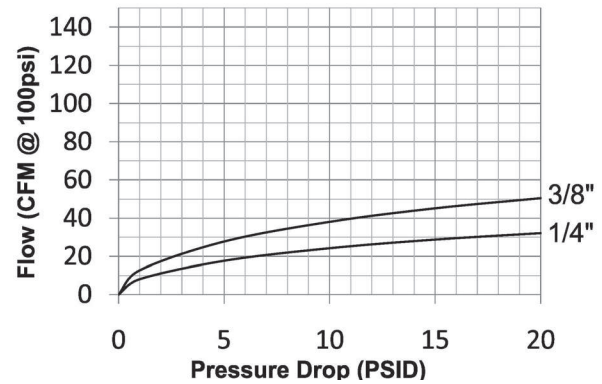
! Muchos coples universales de la competencia no han sido apto para igualar el desempeño y capacidades de la Serie-U de Dixon. Cada acople universal que compite solamente acepta tres estilos de niple neumáticos. Aunque el cople universal permite que una serie de niples embonen, es recomendable combinar solo con coples y niples de la misma serie. Cuando utiliza un cople universal, se toma el valor más bajo de desempeño como precedente.

! Aire seco. Algunas aplicaciones neumáticas requieren que el aire presurizado esté "seco" para asegurar la operación propia del equipo y/o la aplicación correcta del producto (ej. talleres de hojalatería y pintura). Es mejor combinar los acoples y niples con sus series correspondientes en estas aplicaciones. Si es necesario utilizar un acople universal, aplique lubricante al sello y al área de la válvula regularmente para asegurar un servicio confiable.

Coples Neumáticos: Serie-U

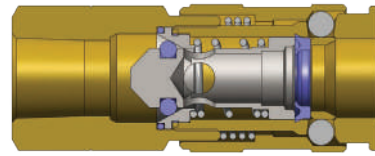

Serie-U Cople Universal Automático (Roscas Hembra)

Medida	Detalle			Medida		DE Máximo		Hex Pulg
	# de Parte	Roscas	Material	Pulg	mm	Pulg	mm	
1/4"	2UF2-B	1/4" - 18 NPT	latón	2.32	59.0	0.92	23.4	3/4"
	2UF3-B	3/8" - 18 NPT	latón	2.32	59.0	0.92	23.4	3/4"
3/8"	3UF3-B	3/8" - 18 NPT	latón	2.54	64.5	1.09	27.7	15/16"

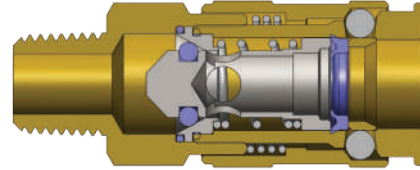

Serie-U Cople Universal Automático (Roscas Macho)

Medida	Detalle			Medida		DE Máximo		Hex Pulg
	# de Parte	Roscas	Material	Pulg	mm	Pulg	mm	
1/4"	2UM2-B	1/4" - 18 NPT	latón	2.44	62.0	0.92	23.4	3/4"
	2UM3-B	3/8" - 18 NPT	latón	2.44	62.0	0.92	23.4	3/4"
3/8"	3UM3-B	3/8" - 18 NPT	latón	2.64	67.0	1.09	27.7	15/16"

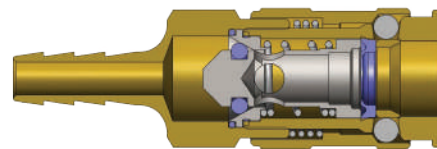
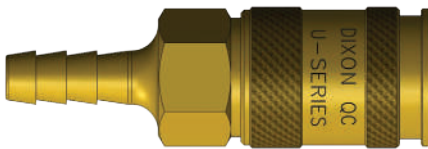

Serie-U Cople Universal Automático (Barbas para Manguera)

Medida	Detalle			Medida		DE Máximo		Hex Pulg
	# de Parte	DI Manguera	Material	Pulg	mm	Pulg	mm	
1/4"	2US2-B	1/4"	latón	2.64	67.0	0.92	23.4	3/4"
	2US3-B	3/8"	latón	2.76	70.0	0.92	23.4	3/4"
3/8"	3US3-B	3/8"	latón	2.99	76.0	1.09	27.7	15/16"

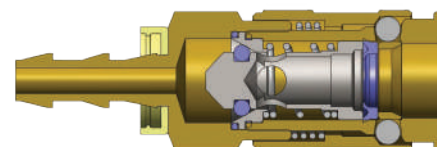
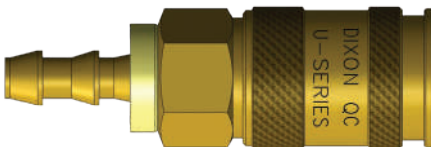

Serie-U Cople Universal Automático (Push-Loc)

Medida	Detalle			Medida		DE Máximo		Hex Pulg
	# de Parte	DI Manguera	Material	Pulg	mm	Pulg	mm	
1/4"	2UB2-B	1/4"	latón	2.52	64.0	0.92	23.4	3/4"
	2UB3-B	3/8"	latón	2.64	67.0	0.92	23.4	3/4"

Información de Intercambio

- Intercambio Bowes Estilo Bayonet
- Intercambiable con Bowes Serie-51000, National Series B, Dix-Lock®, MacDonald Quick-Action, y Campbell Single Lock

Materiales

- Los componentes maquinados son fabricados utilizando barras sólidas de acero, latón o acero inoxidable 303. Acero inoxidable 316 disponible en algunas versiones en orden especial.
- Los resortes y anillos de retención maximiza la resistencia a la corrosión y extienden la vida del servicio.
- Los componentes de acero son platinados con cromo trivalente y cumplen con la norma ROHS
- Tapa guardapolvo con cable de acero
- Los nipples de acero tienen una manga de zincada

- La versión de acero y latón tienen un anillo de seguridad de aluminio mientras que la versión de acero inoxidable tiene un anillo de seguridad de acero inoxidable.

Componentes del Sello

- Sellos de nitrilo (Buna-N) energizados neumáticamente son estándar, brinda un rango de temperatura de -40°F a 250°F (-40°C a 121°C)



Tabla de Presión Nominal

Medida	Serie-N Dix-Lock (Conectado)											
	Cople/Niple Acero				Cople/Niple Latón				A.I. 303 Cople/Niple Acero			
	Max. Trabajo		Reventón		Max. Trabajo		Reventón		Max. Trabajo		Reventón	
	PSI	Bar	PSI	Bar	PSI	Bar	PSI	Bar	PSI	Bar	PSI	Bar
3/8"	500	35	7,000	480	-	-	-	-	-	-	-	-
1/2"	500	35	11,000	755	300	20	8,200	565	500	35	12,600	865

Especificaciones Técnicas

Medida	Estándar Intercambiable				Parámetros Funcionales				
	Ejército USA	Gobierno USA	Estándar Internacional	Estándares ANSI/NFPA	Mecanismo Seguridad	Inclusión de Aire	Pérdida de Flujo	Vacío	Flow ΔP = 10 PSI
3/8"	-	-	-	-	latch tabs	N/A	N/A	N/R	108 CFM
1/2"	MIL-C-3486	A-A-50431A	-	-	latch tabs	N/A	N/A	N/R	204 CFM

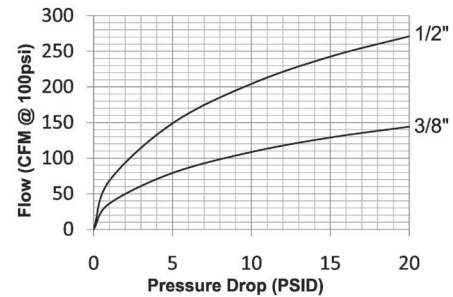
Opciones Disponibles

Medida	Sellos	Opción de Fécula con Vástago			
	FKM	1/2" Barba	3/4" Barba	3/4" Stainless Barba	
	Prefijo	Sufijo	Sufijo	Sufijo	
3/8"	F-	-WF	-WF	-WF	
1/2"	F-	-WF	-WF	-WF	

! La seguridad es de suma importancia cuando instala acoples rápidos en un circuito hidráulico. Nunca instale acoples neumáticos directamente en la herramienta neumática. Utiliza una pieza de manguera que sea por lo menos 18" entre la herramienta y el acople para prevenir de daños el acople. Para proteger al operador, utilizar dispositivos de seguridad como válvulas check e instalar cables de seguridad en caso de que falle el acople o la manguera.

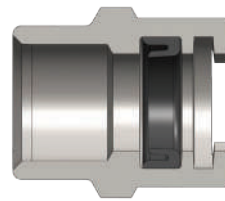
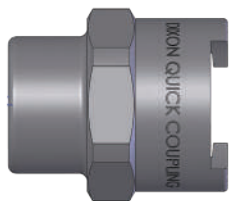

Medida	Serie-N Cople Dix-Lock (Roscas Hembra)							
	Detalle			Medida		DE Máximo		Hex Pulg
	# de Parte	Roscas	Material	Pulg	mm	Pulg	mm	
1/2"	4NBF3	3/8" - 19 BSPP	acero	1.63	41.4	1.54	39.1	1-3/8"
	4NBF4	1/2" - 14 BSPP	acero	1.63	41.4	1.54	39.1	1-3/8"
	4NBF4-B	1/2" - 14 BSPP	latón	1.63	41.4	1.54	39.1	1-3/8"
	4NBF6	3/4" - 14 BSPP	acero	1.63	41.4	1.54	39.1	1-3/8"
	4NBF6-B	3/4" - 14 BSPP	latón	1.63	41.4	1.54	39.1	1-3/8"
	4NBF8	1" - 11 BSPP	acero	1.68	42.6	1.73	43.9	1-1/2"
	4NBF8-B	1" - 11 BSPP	latón	1.68	42.6	1.73	43.9	1-1/2"
	4NF3	3/8" - 18 NPTF	acero	1.63	41.4	1.54	39.1	1-3/8"
	4NF3-B	3/8" - 18 NPTF	latón	1.63	41.4	1.54	39.1	1-3/8"
	4NF4	1/2" - 14 NPTF	acero	1.63	41.4	1.54	39.1	1-3/8"
	4NF4-B	1/2" - 14 NPTF	latón	1.63	41.4	1.54	39.1	1-3/8"
	4NF6	3/4" - 14 NPTF	acero	1.63	41.4	1.54	39.1	1-3/8"
	4NF6-B	3/4" - 14 NPTF	latón	1.63	41.4	1.54	39.1	1-3/8"
	4NF6-S	3/4" - 14 NPTF	A.I. 303	1.63	41.4	1.54	39.1	1-3/8"
	4NF6-SS	3/4" - 14 NPTF	A.I. 316	1.63	41.4	1.54	39.1	1-3/8"
	4NF8	1" - 11-1/2 NPTF	acero	1.68	42.6	1.73	43.9	1-1/2"
	4NF8-B	1" - 11-1/2 NPTF	latón	1.68	42.6	1.73	43.9	1-1/2"
	4NF8-SS	1" - 11-1/2 NPTF	A.I. 316	1.68	42.6	1.73	43.9	1-1/2"

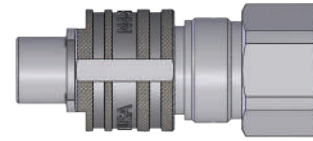
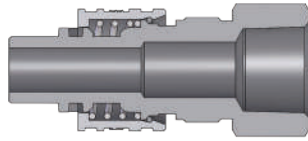

Medida	Serie-N Niple Dix-Lock (Roscas Hembra)							
	Detalle			Medida		DE Máximo		Hex Pulg
	# de Parte	Roscas	Material	Pulg	mm	Pulg	mm	
1/2"	N4BF3	3/8" - 19 BSPP	acero	2.92	74.0	1.31	33.3	1-3/16"
	N4BF4	1/2" - 14 BSPP	acero	2.92	74.0	1.31	33.3	1-3/16"
	N4BF4-B	1/2" - 14 BSPP	latón	2.92	74.0	1.31	33.3	1-3/16"
	N4BF6	3/4" - 14 BSPP	acero	3.42	86.7	1.50	38.1	1-3/8"
	N4BF6-B	3/4" - 14 BSPP	latón	3.42	86.7	1.50	38.1	1-3/8"
	N4BF8	1" - 11 BSPP	acero	3.59	91.2	1.79	45.3	1-5/8"
	N4BF8-B	1" - 11 BSPP	latón	3.59	91.2	1.79	45.3	1-5/8"
	N4F3	3/8" - 18 NPTF	acero	2.92	74.0	1.31	33.3	1-3/16"
	N4F3-B	3/8" - 18 NPTF	latón	2.92	74.0	1.31	33.3	1-3/16"
	N4F4	1/2" - 14 NPTF	acero	2.92	74.0	1.31	33.3	1-3/16"
	N4F4-B	1/2" - 14 NPTF	latón	2.92	74.0	1.31	33.3	1-3/16"
	N4F6	3/4" - 14 NPTF	acero	3.42	86.7	1.50	38.1	1-3/8"
	N4F6-B	3/4" - 14 NPTF	latón	3.42	86.7	1.50	38.1	1-3/8"
	N4F6-S	3/4" - 14 NPTF	A.I. 303	3.42	86.7	1.50	38.1	1-3/8"
	N4F6-SS	3/4" - 14 NPTF	A.I. 316	3.42	86.7	1.50	38.1	1-3/8"
	N4F8	1" - 11-1/2 NPTF	acero	3.59	91.2	1.79	45.3	1-5/8"
N4F8-B	1" - 11-1/2 NPTF	latón	3.59	91.2	1.79	45.3	1-5/8"	
N4F8-SS	1" - 11-1/2 NPTF	A.I. 316	3.59	91.2	1.79	45.3	1-5/8"	

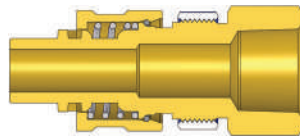

Medida	Serie-N Niple Dix-Lock con Manga de Seguridad (Roscas Hembra)							
	Detalle			Medida		DE Máximo		Hex Pulg
	# de Parte	Roscas	Material	Pulg	mm	Pulg	mm	
1/2"	N4F4-B-LS	1/2" - 14 NPTF	latón	2.92	74.0	1.31	33.3	1-3/16"
	N4F6-B-LS	3/4" - 14 NPTF	latón	3.42	86.7	1.50	38.1	1-3/8"
	N4F6-LS	3/4" - 14 NPTF	acero	3.42	86.70	1.50	38.10	1-3/8"

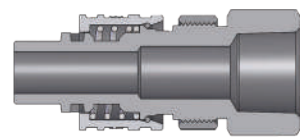

Medida	Serie-N Niple Dix-Lock con Manga de Seguridad de Acero (Roscas Hembra)							
	Detalle			Medida		DE Máximo		Hex Pulg
	# de Parte	Roscas	Material	Pulg	mm	Pulg	mm	
1/2"	N4F6-ZLS	3/4" - 14 NPTF	acero	1.63	41.40	1.54	39.10	1-3/8"

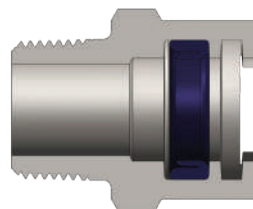

Medida	Serie-N Cople Dix-Lock (Roscas Macho)							
	Detalle			Medida		DE Máximo		Hex Pulg
	# de Parte	Roscas	Material	Pulg	mm	Pulg	mm	
3/8"	3NBM4	1/2" - 14 BSPT	acero	1.73	43.8	1.1	27.9	1"
	3NM4	1/2" - 14 NPTF	acero	1.8	45.7	1.1	27.9	1"
1/2"	4NBM3	3/8" - 19 BSPT	acero	1.66	42.2	1.5	38.1	1-3/8"
	4NBM4	1/2" - 14 BSPT	acero	1.75	44.5	1.5	38.1	1-3/8"
	4NBM4-B	1/2" - 14 BSPT	latón	1.75	44.5	1.5	38.1	1-3/8"
	4NBM6	3/4" - 14 BSPT	acero	1.85	47	1.5	38.1	1-3/8"
	4NBM6-B	3/4" - 14 BSPT	latón	1.85	47	1.5	38.1	1-3/8"
	4NBM8	1" - 11 BSPT	acero	1.95	49.5	1.5	38.1	1-1/2"
	4NBM8-B	1" - 11 BSPT	latón	1.95	49.5	1.5	38.1	1-1/2"
	4NM3	3/8" - 18 NPTF	acero	1.66	42.2	1.5	38.1	1-3/8"
	4NM3-B	3/8" - 18 NPTF	latón	1.66	42.2	1.5	38.1	1-3/8"
	4NM4	1/2" - 14 NPTF	acero	1.85	47	1.5	38.1	1-3/8"
	4NM4-B	1/2" - 14 NPTF	latón	1.85	47	1.5	38.1	1-3/8"
	4NM6	3/4" - 14 NPTF	acero	1.85	47	1.5	38.1	1-3/8"
	4NM6-B	3/4" - 14 NPTF	latón	1.85	47	1.5	38.1	1-3/8"
	4NM6-S	3/4" - 14 NPTF	A.I. 303	1.85	47	1.5	38.1	1-3/8"
	4NM6-SS	3/4" - 14 NPTF	A.I. 316	1.85	47	1.5	38.1	1-3/8"
	4NM8	1" - 11-1/2 NPTF	acero	1.95	49.5	1.5	38.1	1-1/2"
	4NM8-B	1" - 11-1/2 NPTF	latón	1.95	49.5	1.5	38.1	1-1/2"
	4NM8-SS	1" - 11-1/2 NPTF	A.I. 316	1.95	49.5	1.5	38.1	1-1/2"

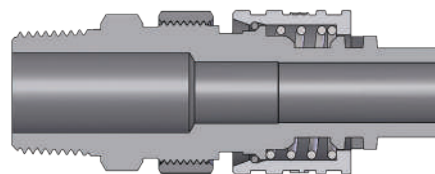
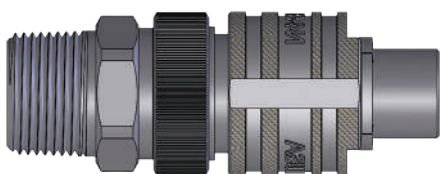

Medida	Serie-N Niple Intercambio Dix-Lock N con Manga de Seguridad de Acero (Roscas Macho)							
	Detalle			Medida		DE Máximo		Hex Pulg
	# de Parte	Roscas	Material	Pulg	mm	Pulg	mm	
1/2"	N4M6-ZLS	3/4" - 14 NPTF	acero	3.65	92.70	1.31	33.30	1-3/16"

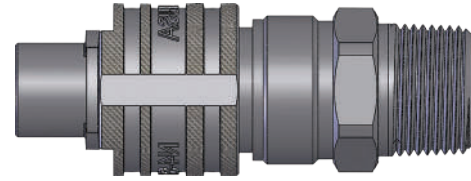
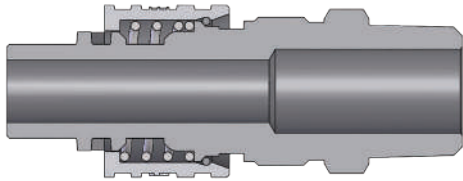

Serie-N Niple Dix-Lock (Roscas Macho)

Medida	Detalle			Medida		DE Máximo		Hex Pulg
	# de Parte	Roscas	Material	Pulg	mm	Pulg	mm	
3/8"	N3BM4	1/2" - 14 BSPT	acero	3.36	85.3	1.13	28.6	1"
	N3M4	1/2" - 14 NPTF	acero	3.36	85.3	1.13	28.6	1"
1/2"	N4BM3	3/8" - 19 BSPT	acero	3.46	87.9	1.31	33.3	1-3/16"
	N4BM4	1/2" - 14 BSPT	acero	3.65	92.7	1.31	33.3	1-3/16"
	N4BM4-B	1/2" - 14 BSPT	latón	3.65	92.7	1.31	33.3	1-3/16"
	N4BM6	3/4" - 14 BSPT	acero	3.65	92.7	1.31	33.3	1-3/16"
	N4BM6-B	3/4" - 14 BSPT	latón	3.64	92.7	1.31	33.3	1-3/16"
	N4BM8	1" - 11 BSPT	acero	3.89	98.8	1.51	38.4	1-3/8"
	N4BM8-B	1" - 11 BSPT	latón	3.89	98.8	1.51	38.4	1-3/8"
	N4M3	3/8" - 18 NPTF	acero	3.46	87.9	1.31	33.3	1-3/16"
	N4M3-B	3/8" - 18 NPTF	latón	3.46	87.9	1.31	33.3	1-3/16"
	N4M4	1/2" - 14 NPTF	acero	3.65	92.7	1.31	33.3	1-3/16"
	N4M4-B	1/2" - 14 NPTF	latón	3.65	92.7	1.31	33.3	1-3/16"
	N4M6	3/4" - 14 NPTF	acero	3.65	92.7	1.31	33.3	1-3/16"
	N4M6-B	3/4" - 14 NPTF	latón	3.65	92.7	1.31	33.3	1-3/16"
	N4M6-S	3/4" - 14 NPTF	A.I. 303	3.65	92.7	1.31	33.3	1-3/16"
	N4M6-SS	3/4" - 14 NPTF	A.I. 316	3.65	92.7	1.31	33.30	1-3/16"
	N4M8	1" - 11-1/2 NPTF	acero	3.89	98.8	1.51	38.4	1-3/8"
	N4M8-B	1" - 11-1/2 NPTF	latón	3.89	98.8	1.51	38.4	1-3/8"
	N4M8-SS	1" - 11-1/2 NPTF	A.I. 316	3.89	98.8	1.51	38.40	1-3/8"

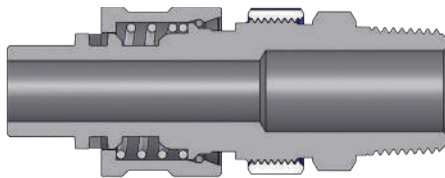

Serie-N Niple Dix-Lock con Manga de Seguridad (Roscas Macho)

Medida	Detalle			Medida		DE Máximo		Hex Pulg
	# de Parte	Roscas	Material	Pulg	mm	Pulg	mm	
1/2"	N4BM4-LS	1/2" - 14 BSPT	acero	3.65	92.7	1.31	33.3	1-3/16"
	N4BM6-LS	3/4" - 14 BSPT	acero	3.65	92.7	1.31	33.3	1-3/16"
	N4M4-B-LS	1/2" - 14 NPTF	latón	3.65	92.7	1.31	33.3	1-3/16"
	N4M4-LS	1/2" - 14 NPTF	acero	3.65	92.7	1.31	33.3	1-3/16"
	N4M6-B-LS	3/4" - 14 NPTF	latón	3.65	92.7	1.31	33.3	1-3/16"
	N4M6-LS	3/4" - 14 NPTF	acero	3.65	92.7	1.31	33.3	1-3/16"
	N4M6-S-LS	3/4" - 14 NPTF	A.I. 303	3.65	92.7	1.31	33.3	1-3/16"

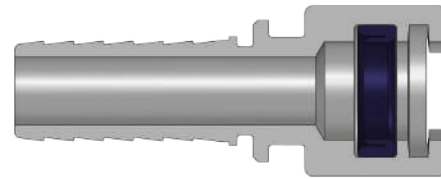
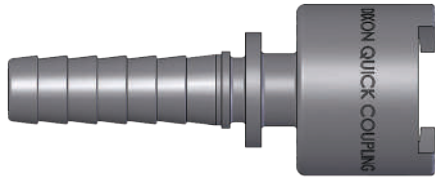

Serie-N Cople Dix-Lock (Barbas para Manguera)

Medida	Detalle			Medida		DE Máximo	
	# de Parte	DI Manguera	Material	Pulg	mm	Pulg	mm
3/8"	3NCS4	1/2"	acero	4.74	120.4	0.99	25.1
	4NS3	3/8"	acero	4.54	115.3	1.4	35.6
	4NS3-B	3/8"	latón	4.54	115.3	1.4	35.6
	4NS4	1/2"	acero	4.95	125.7	1.4	35.6
	4NS4-B	1/2"	latón	4.95	125.7	1.4	35.6
1/2"	4NS6	3/4"	acero	4.95	125.7	1.4	35.6
	4NS6-B	3/4"	latón	4.95	125.7	1.4	35.6
	4NS6-S	3/4"	A.I. 303	4.95	125.7	1.4	35.6
	4NS6-SS	3/4"	A.I. 316	4.95	125.7	1.4	35.6
	4NS8	1"	acero	5.77	146.4	1.4	35.6
	4NS8-B	1"	latón	5.77	146.4	1.4	35.6
	4NS8-S	1"	A.I. 303	5.77	146.4	1.4	35.6
	4NS8-SS	1"	A.I. 316	5.77	146.4	1.4	35.6

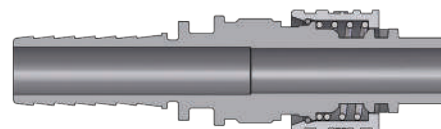

Serie-N Niple Dix-Lock (Barbas para Manguera)

Medida	Detalle			Medida		DE Máximo	
	# de Parte	DI Manguera	Material	Pulg	mm	Pulg	mm
3/8"	N3CS4	1/2"	acero	3.73	94.8	1.13	28.6
	N4S3	3/8"	acero	4.36	110.7	1.4	35.6
	N4S3-B	3/8"	latón	4.36	110.7	1.4	35.6
	N4S4	1/2"	acero	4.63	117.6	1.4	35.6
	N4S4-B	1/2"	latón	4.63	117.6	1.4	35.6
1/2"	N4S6	3/4"	acero	4.77	121.2	1.4	35.6
	N4S6-B	3/4"	latón	4.77	121.2	1.4	35.6
	N4S6-S	3/4"	A.I. 303	4.77	121.2	1.4	35.6
	N4S6-SS	3/4"	A.I. 316	4.77	121.2	1.4	35.6
	N4S8	1"	acero	4.77	121.2	1.4	35.6
	N4S8-B	1"	latón	4.77	121.2	1.4	35.6
	N4S8-S	1"	A.I. 303	4.77	121.2	1.4	35.6
	N4S8-SS	1"	A.I. 316	4.77	121.2	1.4	35.6

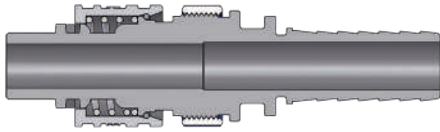

Serie-N Niple Dix-Lock con Manga de Seguridad (Barbas para Manguera)								
Medida	Detalle			Medida		DE Máximo		Hex Pulg
	# de Parte	DI Manguera	Material	Pulg	mm	Pulg	mm	
1/2"	N4S4-LS	1/2"	acero	4.95	125.7	1.40	35.6	-
	N4S4-B-LS	1/2"	latón	4.95	125.7	1.40	35.6	-
	N4S6-LS	3/4"	acero	4.95	125.7	1.40	35.6	-
	N4S6-B-LS	3/4"	latón	4.95	125.7	1.40	35.6	-
	N4S6-S-LS	3/4"	A.I. 303	4.95	125.7	1.40	35.6	-

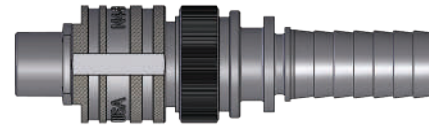
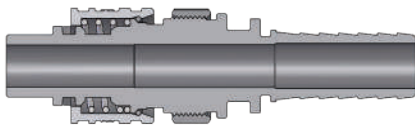

Serie-N Niple Intercambio Dix-Lock con Manga de Seguridad de Acero (Barbas para Manguera)								
Medida	Detalle			Medida		DE Máximo		Hex Pulg
	# de Parte	Roscas	Material	Pulg	mm	Pulg	mm	
1/2"	N4S6-ZLS	3/4" barba	acero	4.77	121.20	1.40	35.60	-

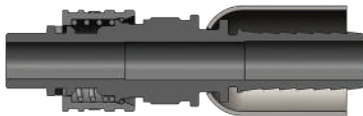

Serie-N Cople Dix-Lock con Férula (Barbas para Manguera)									
Medida	Detalle			DE Manguera		Medida		DE Máximo	
	# de Parte	DI Manguera	Material	De	A	Pulg	mm	Pulg	mm
1/2"	N4S4-WF	1/2" barba	acero	54/64"	1-2/64"	4.95	125.70	1.40	35.60
	N4S6-WF	3/4" barba	acero	1-10/64"	1-22/64"	4.95	125.70	1.40	35.60
	N4S4-B-WF	1/2" barba	latón	54/64"	1-2/64"	4.95	125.70	1.40	35.60
	N4S6-B-WF	3/4" barba	latón	1-10/64"	1-22/64"	4.95	125.70	1.40	35.60
	N4S6-S-WF	3/4" barba	A.I. 303	1-10/64"	1-22/64"	4.95	125.70	1.40	35.60

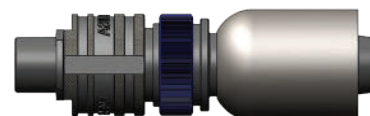
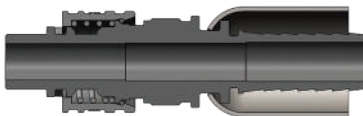

Serie-N Niple Dix-Lock con Manga de Seguridad y Férula (Barbas para Manguera)									
Medida	Detalle			DE Manguera		Medida		DE Máximo	
	# de Parte	DI Manguera	Material	De	A	Pulg	mm	Pulg	mm
1/2"	N4S4-B-LS-WF	1/2" barba	latón	54/64"	1-2/64"	4.95	125.70	1.40	35.60
	N4S6-B-LS-WF	3/4" barba	latón	1-10/64"	1-22/64"	4.95	125.70	1.40	35.60
	N4S4-LS-WF	1/2" barba	acero	54/64"	1-2/64"	4.95	125.70	1.40	35.60
	N4S6-LS-WF	3/4" barba	acero	1-10/64"	1-22/64"	4.95	125.70	1.40	35.60

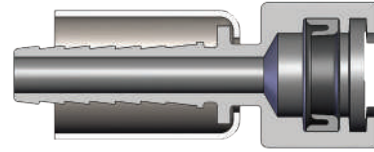
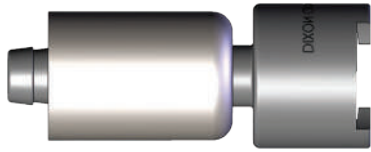

Serie-N Cople Dix-Lock con Fécula (Barbas para Manguera)

Medida	Detalle			Hose OD		Medida		DE Máximo	
	# de Parte	DI Manguera	Material	De	A	Pulg	mm	Pulg	mm
1/2"	4NS4-WF	1/2" barba	acero	54/64"	1-2/64"	4.95	125.70	1.40	35.60
	4NS4-B-WF	1/2" barba	latón	54/64"	1-2/64"	4.95	125.70	1.40	35.60
	4NS6-WF	3/4" barba	acero	1-10/64"	1-22/64"	4.95	125.70	1.40	35.60
	4NS6-B-WF	3/4" barba	latón	1-10/64"	1-22/64"	4.95	125.70	1.40	35.60

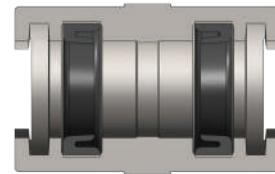
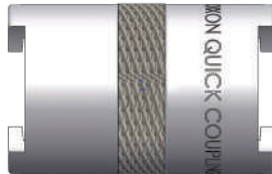

Serie-N Unión Dix-Lock

Medida	Detalle			Medida		DE Máximo		Hex Pulg
	# de Parte	Configuración	Material	Pulg	mm	Pulg	mm	
1/2"	4N4N	cople a cople	acero	3.26	82.8	1.33	33.8	-

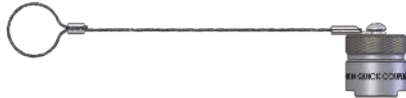

Serie-N Tapa Protectora Dix-Lock

Medida	Detalle			Medida		DE Máximo		Hex Pulg
	# de Parte	Cap Lanyard	Material	Pulg	mm	Pulg	mm	
1/2"	N4DC	cable de acero	acero	1.50	38.1	1.33	33.8	-
	N4DC-B	cable de acero	latón	1.50	38.1	1.33	33.8	-

Serie-N Sellos de Reemplazo Dix-Lock

Medida	Detalle			Contenido del Kit de Sellos
	# de Parte	Estilo de Cople	Material de Sello	
3/8"	3N-SKIT	todos	Nitrilo	Sello Neumáticamente Energizado
1/2"	4N-SKIT	todos	Nitrilo	
	F-4N-SKIT	todos	FKM	

Información de Intercambio

- Intercambio Thor Finger-Lock
- Intercambiable con Thor Serie-PHC, National Series A, Dual-Lock, y Campbell Double Lock

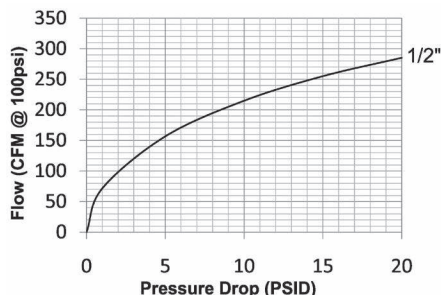

Materiales

- Los componentes son maquinados con barras sólidas de acero, latón o acero inoxidable 303
- Anillos de retención y resorte de acero inoxidable maximizan la resistencia a la corrosión y extienden la vida de servicio en la manga de 1-pieza; la manga de 2-piezas tiene un resorte de fósforo de bronce
- Los componentes de acero son platinados con cromo trivalente y cumplen con la norma ROHS
- Los acoples de acero tienen una manga zincada

Componentes del Sello

- Sellos de Nitrilo (Buna-N) estándar brindan un rango de temperatura de -40°F a 250°F (-40°C a 121°C)

Tabla de Presión Nominal

Medida	Serie-P Dual-Lock Intercambio Thor (Conectado)											
	Cople/Niple Acero				Cople/Niple Latón				A.I. 303 Cople/Niple Acero			
	Max. Trabajo		Reventón		Max. Trabajo		Reventón		Max. Trabajo		Reventón	
	PSI	Bar	PSI	Bar	PSI	Bar	PSI	Bar	PSI	Bar	PSI	Bar
1/2"	300	20	2,600	180	300	20	3,500	240	300	20	4,500	310

Especificaciones Técnicas

Me- di- da	Estándar Intercambiable				Parámetros Funcionales				
	Ejército USA	Gobierno USA	Estándar Internacional	Estándares ANSI/NFPA	Mecanismo de Seguridad	Inclusión de Aire	Pérdida de Flujo	Vacío	Flujo ΔP = 15 PSI
1/2"	-	-	-	-	Latch Fingers	N/A	N/A	N/R	255 CFM

Opciones Disponibles

Me- di- da	Sellos	Opciones de Manga		Opción de Férrula para Vástago		
	FKM	Bridado	Lock Clip	1/2" Barba	3/4" Barba	3/4" Barbas Inox
	Prefijo	Sufijo	# de Parte	Sufijo	Sufijo	Sufijo
1/2"	F-	-FS	4P-CLIP	-WF	-WF	-WF

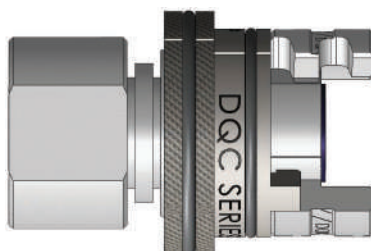

Serie-P Cople Dual-Lock con Opción de Manga Bridada -FS

Coples Neumáticos: Serie-P Dual-Lock

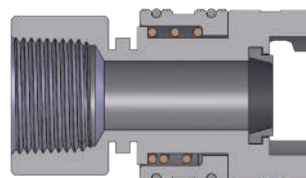
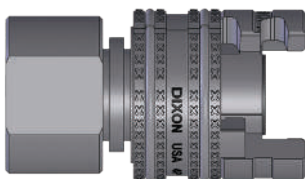

Serie-P Cople Dual-Lock (Roscas Hembra)

Medida	Detalle			Medida		DE Máximo		Llave
	# de Parte	Roscas	Material	Pulg	mm	Pulg	mm	
1/2"	4PF4	1/2" - 14 NPTF	acero	2.75	69.9	1.55	39.4	1-1/4"
	4PF6	3/4" - 14 NPTF	acero	2.75	69.9	1.55	39.4	1-1/4"
	4PF6-B	3/4" - 14 NPTF	latón	2.75	69.9	1.55	39.4	1-1/4"
	4PF6-S	3/4" - 14 NPTF	A.I. 303	2.75	69.9	1.55	39.4	1-1/4"

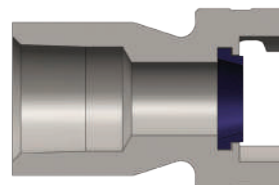
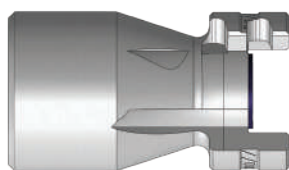

Serie-P Niple Dual-Lock (Roscas Hembra)

Medida	Detalle			Medida		DE Máximo		Llave
	# de Parte	Roscas	Material	Pulg	mm	Pulg	mm	
1/2"	P4F3	3/8" - 18 NPTF	acero	1.79	45.5	1.55	39.4	7/8"
	P4F4	1/2" - 14 NPTF	acero	2.25	57.2	1.55	39.4	1-5/16"
	P4F4-B	1/2" - 14 NPTF	latón	2.25	57.2	1.55	39.4	1-5/16"
	P4F6	3/4" - 14 NPTF	acero	2.34	59.4	1.55	39.4	1-5/16"
	P4F6-9	3/4" - 14 NPTF	acero/cubierta PTFE	2.34	59.4	1.55	39.4	1-5/16"
	P4F6-B	3/4" - 14 NPTF	latón	2.34	59.4	1.55	39.4	1-5/16"
	P4F6-S	3/4" - 14 NPTF	A.I. 303	2.34	59.4	1.55	39.4	1-5/16"
	P4F8	1" - 11-1/2 NPTF	acero	2.76	70.1	1.55	39.4	1-7/16"
	P4F8-B	1" - 11-1/2 NPTF	latón	2.76	70.1	1.55	39.4	1-7/16"

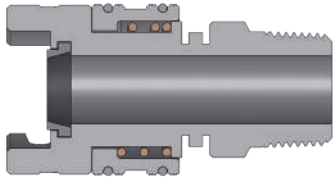

Medida	Serie-P Cople Dual-Lock (Roscas Macho)							
	Detalle			Medida		DE Máximo		Llave
	# de Parte	Roscas	Material	Pulg	mm	Pulg	mm	
1/2"	4PM3	3/8" - 18 NPTF	acero	2.93	74.4	1.55	39.4	7/8"
	4PM4	1/2" - 14 NPTF	acero	2.94	74.7	1.55	39.4	7/8"
	4PM6	3/4" - 14 NPTF	acero	2.98	75.7	1.55	39.4	1-1/16"
	4PM6-9	3/4" - 14 NPTF	acero/cubierta PTFE	2.98	75.7	1.55	39.4	1-1/16"
	4PM6-S	3/4" - 14 NPTF	A.I. 303	2.98	75.7	1.55	39.4	1-1/16"
	4PM8	1" - 11-1/2 NPTF	acero	3.11	79.0	1.55	39.4	1-3/8"

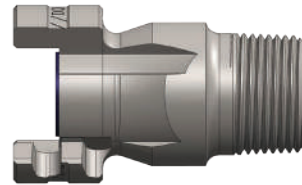
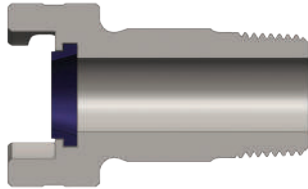

Medida	Serie-P Niple Dual-Lock (Roscas Macho)							
	Detalle			Medida		DE Máximo		Llave
	# de Parte	Roscas	Material	Pulg	mm	Pulg	mm	
1/2"	P4M3	3/8" - 18 NPTF	acero	2.00	50.8	1.55	39.4	7/8"
	P4M4	1/2" - 14 NPTF	acero	2.25	57.2	1.55	39.4	15/16"
	P4M4-B	1/2" - 14 NPTF	latón	2.25	57.2	1.55	39.4	15/16"
	P4M6	3/4" - 14 NPTF	acero	2.55	64.8	1.55	39.4	1-1/8"
	P4M6-9	3/4" - 14 NPTF	acero/cubierta PTFE	2.55	64.8	1.55	39.4	1-1/8"
	P4M6-B	3/4" - 14 NPTF	latón	2.55	64.8	1.55	39.4	1-1/8"
	P4M6-S	3/4" - 14 NPTF	A.I. 303	2.55	64.8	1.55	39.4	1-1/8"
	P4M8	1" - 11-1/2 NPTF	acero	3.25	82.6	1.55	39.4	1-3/8"
	P4M8-B	1" - 11-1/2 NPTF	latón	3.25	82.6	1.55	39.4	1-3/8"

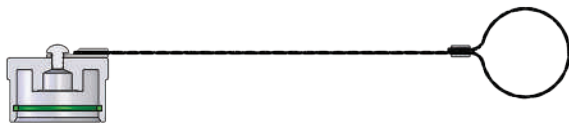

Medida	Serie-P Tapa Dual-Lock		
	Detalle		
	# de Parte	Tapa con cordón	Material
1/2"	4PDC-A	acero	aluminio

Coples Neumáticos: Serie-P Dual-Lock

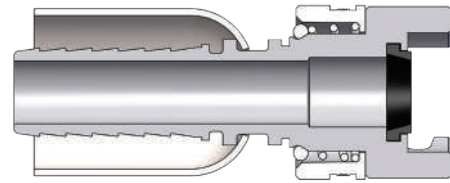
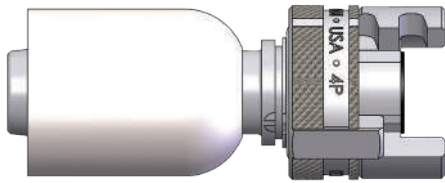

Serie-P Cople Dual-Lock con Férula (Barbas para Manguera)

Medida	Detalle			DE Manguera		Medida		DE Máximo	
	# de Parte	DI Manguera	Material	De	A	Pulg	mm	Pulg	mm
1/2"	4PS4-WF	1/2" barbas	acero	54/64"	1-2/64"	3.95	100.30	1.55	39.40
	4PS4-B-WF	1/2" barbas	latón	54/64"	1-2/64"	3.95	100.30	1.55	39.40
	4PS6-WF	3/4" barbas	acero	1-10/64"	1-22/64"	3.95	100.30	1.55	39.40
	4PS6-B-WF	3/4" barbas	latón	1-10/64"	1-22/64"	3.95	100.30	1.55	39.40
	4PS6-S-WF	3/4" barbas	A.I. 303	1-10/64"	1-22/64"	3.95	100.30	1.55	39.40

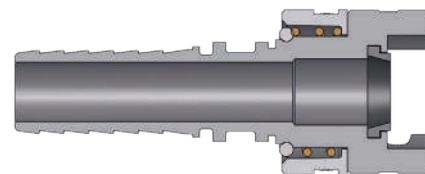

Serie-P Cople Dual-Lock (Barbas para Manguera)

Medida	Detalle			Medida		DE Máximo		Hex Pulg
	# de Parte	DI Manguera	Material	Pulg	mm	Pulg	mm	
1/2"	4PS3	3/8"	acero	3.53	89.7	1.55	39.4	-
	4PS4	1/2"	acero	3.95	100.3	1.55	39.4	-
	4PS4-B	1/2"	latón	3.95	100.3	1.55	39.4	-
	4PS6	3/4"	acero	3.95	100.3	1.55	39.4	-
	4PS6-9	3/4"	acero/cubierta PTFE	3.95	100.3	1.55	39.4	-
	4PS6-B	3/4"	latón	3.95	100.3	1.55	39.4	-
	4PS6-S	3/4"	A.I. 303	3.95	100.3	1.55	39.4	-
	4PS8	1"	acero	6.06	153.9	1.55	39.4	-
	4PS8-B	1"	latón	6.06	153.9	1.55	39.4	-

Serie-P Sellos de Reemplazo Dual-Lock

Medida	Detalle			Contenido del Kit de Sellos
	# de Parte	Estilo de Cople	Material	
1/2"	4P-SKIT	todos	Nitrilo	empaque sellador
	F-4P-SKIT	todos	FKM	empaque sellador

Información de Intercambio

- Intercambio con Cople neumático industrial japonés
- Nitto Kohki Hi-Cupla 200, Rectus Serie 13, y CEJN Serie 315

Materiales

- Los componentes son maquinados con barras sólidas de acero
- Resortes de acero inoxidable, balines y anillo de retención de acero al carbón
- Los componentes de acero están platinados con cromo-sobre-níquel

Componentes del Sello

- Sellos de Nitrilo (Buna-N) estándar brindan un rango de temperatura de **-40°F a 250°F (-40°C a 121°C)**



Tabla de Presión Nominal

Medida	Serie-NK Intercambio Industrial Japonés (Conectado)			
	Cople/Niple			
	Trabajo Máximo		Reventón	
	PSI	Bar	PSI	Bar
1/4"	300	20	13,500	931

Especificaciones Técnicas

Medida	Estándar Intercambiable				Parámetros Funcionales				
	Ejército USA	Gobierno USA	Estándar Internacional	Estándares ANSI/NFPA	Cantidad Balines	Inclusión de Aire	Pérdida de Flujo	Vacío	Flujo ΔP = 15 PSI
1/4"	-	-	-	-	4	N/A	N/A	N/R	42 CFM

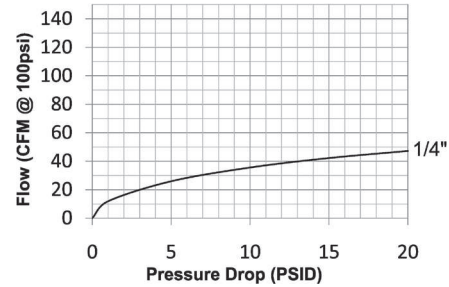
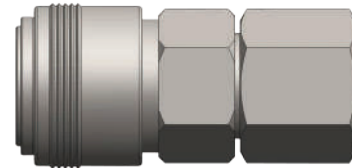
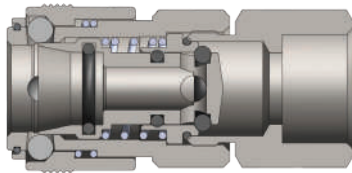

Serie-NK Cople Intercambio Industrial Japonés (Roscas Hembra)

Medida	Detalle			Medida		DE Máximo		Hex Pulg
	# de Parte	Roscas	Material	Pulg	mm	Pulg	mm	
1/4"	2NKF2	1/4" - 18 NPT	acero	1.97	50.0	1.02	26.0	3/4"
	2NKBF2	1/4" - 19 BSPP	acero	1.97	50.0	1.02	26.0	3/4"

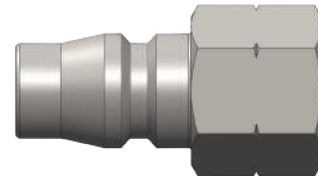
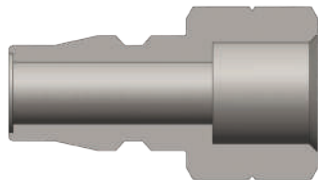

Serie-NK Niple Intercambio Industrial Japonés (Roscas Hembra)

Medida	Detalle			Medida		DE Máximo		Hex Pulg
	# de Parte	Roscas	Material	Pulg	mm	Pulg	mm	
1/4"	NK2F2	1/4" - 18 NPT	acero	1.39	35.2	0.52	13.1	5/8"
	NK2BF2	1/4" - 19 BSPP	acero	1.39	35.2	0.52	13.1	5/8"

Coples Neumáticos: Serie-NK

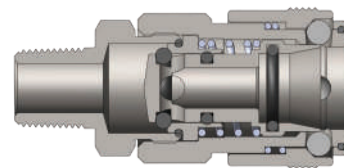
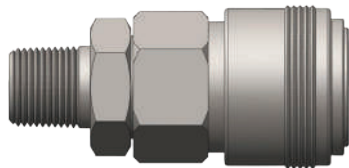

Serie-NK Cople Intercambio Industrial Japonés (Roscas Macho)								
Medida	Detalle			Medida		DE Máximo		Hex Pulg
	# de Parte	Roscas	Material	Pulg	mm	Pulg	mm	
1/4"	2NKM2	1/4" - 18 NPT	acero	2.12	54.0	1.02	26.0	3/4"
	2NKBM2	1/4" - 19 BSPT	acero	2.12	54.0	1.02	26.0	3/4"

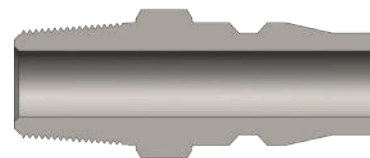
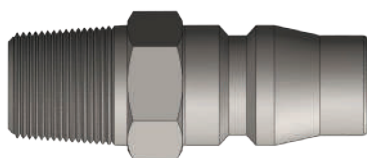

Serie-NK Niple Intercambio Industrial Japonés (Roscas Macho)								
Medida	Detalle			Medida		DE Máximo		Hex Pulg
	# de Parte	Roscas	Material	Pulg	mm	Pulg	mm	
1/4"	NK2M2	1/4" - 18 NPT	acero	1.54	39.2	0.52	13.1	5/8"
	NK2BM2	1/4" - 19 BSPT	acero	1.54	39.2	0.52	13.1	5/8"

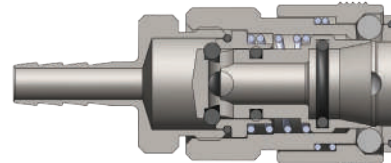
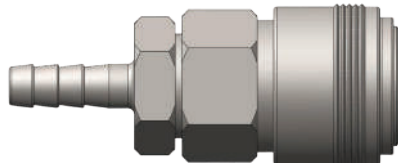

Serie-NK Cople Intercambio Industrial Japonés (Barbas para Manguera)								
Medida	Detalle			Medida		DE Máximo		Hex Pulg
	# de Parte	DI Manguera	Material	Pulg	mm	Pulg	mm	
1/4"	2NKS2	1/4"	acero	2.40	61.0	1.02	26.0	3/4"

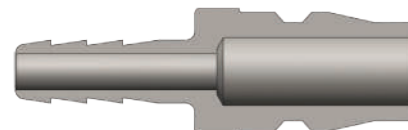

Serie-NK Niple Intercambio Industrial Japonés (Barbas para Manguera)								
Medida	Detalle			Medida		DE Máximo		Hex Pulg
	# de Parte	DI Manguera	Material	Pulg	mm	Pulg	mm	
1/4"	NK2S2	1/4"	acero	1.78	45.2	0.44	11.3	-

Información de Intercambio

- Rectus 21KA, CEJN Serie 223

Materiales

- Los componentes son maquinados con barras sólidas de latón.
- Resortes de acero al carbón; balines y anillos de retención de acero al carbón
- Los componentes de acero están platinados con cromo-sobre-níquel

Componentes del Sello

- Sellos de Nitrilo (Buna-N) estándar brindan un rango de temperatura de -40°F a 250°F (-40°C a 121°C)



Tabla de Presión Nominal

Medida	Serie-BR Intercambio Serie-21 (Conectado)			
	Cople/Niple			
	Trabajo Máximo		Reventón	
	PSI	Bar	PSI	Bar
1/8"	300	20	7,000	483

Especificaciones Técnicas

Medida	Estándar Intercambiable				Parámetros Funcionales				
	Ejército USA	Gobierno USA	Estándar Internacional	Estándares ANSI/NFPA	Cantidad Balines	Inclusión de Aire	Pérdida de Flujo	Vacío	Flujo ΔP = 15 PSI
1/4"	-	-	-	-	6	N/A	N/A	N/R	20 CFM

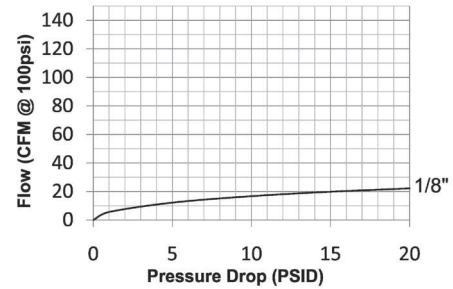
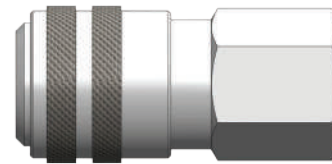
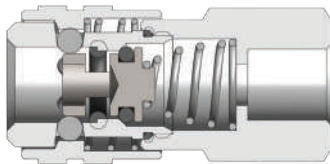

Serie-BR Cople Intercambio Serie-21 (Rosca Hembra)

Medida	Serie-BR Cople Intercambio Serie-21 (Rosca Hembra)							
	Detalle			Medida		DE Máximo		Hex Pulg
	# de Parte	Roscas	Material	Pulg	mm	Pulg	mm	
1/8"	1BRF1-B-7	1/8" - 27 NPT	latón	1.55	39.4	0.65	16.5	9/16"
	1BRBF1-B-7	1/8" - 28 BSPP	latón	1.55	39.4	0.65	16.5	9/16"
	1BRF2-B-7	1/4" - 18 NPT	latón	1.77	45.0	0.72	18.3	5/8"
	1BRBF2-B-7	1/4" - 19 BSPP	latón	1.77	45.0	0.72	18.3	5/8"

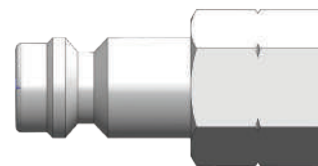
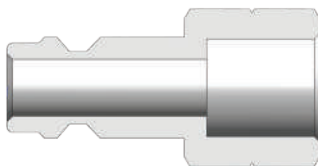

Serie-BR Niple Intercambio Serie-21 (Rosca Hembra)

Medida	Serie-BR Niple Intercambio Serie-21 (Rosca Hembra)							
	Detalle			Medida		DE Máximo		Hex Pulg
	# de Parte	Roscas	Material	Pulg	mm	Pulg	mm	
1/8"	BR1F1-B-E-7	1/8" - 27 NPT	latón	1.14	29.0	0.65	16.5	9/16"
	BR1BF1-B-E-7	1/8" - 28 BSPP	latón	1.14	29.0	0.65	16.5	9/16"
	BR1F2-B-E-7	1/4" - 18 NPT	latón	1.33	33.8	0.72	18.3	5/8"
	BR1BF2-B-E-7	1/4" - 19 BSPP	latón	1.33	33.8	0.72	18.3	5/8"

Coples Neumáticos: Serie-BR

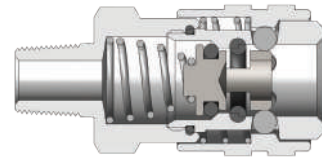
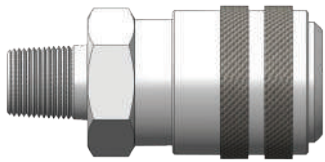

Medida	Serie-BR Cople Intercambio Serie-21 (Rosca Macho)							
	Detalle			Medida		DE Máximo		Hex Pulg
	# de Parte	Roscas	Material	Pulg	mm	Pulg	mm	
1/8"	1BRM1-B-7	1/8" - 27 NPT	latón	1.49	37.8	0.65	16.5	9/16"
	1BRGM1-B-7	1/8" - 28 BSPP	latón	1.49	37.8	0.65	16.5	9/16"
	1BRM2-B-7	1/4" - 18 NPT	latón	1.61	40.9	0.72	18.3	5/8"
	1BRGM2-B-7	1/4" - 19 BSPP	latón	1.61	40.9	0.72	18.3	5/8"

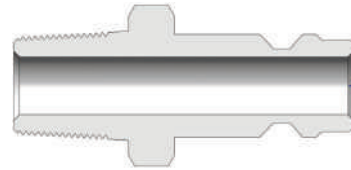
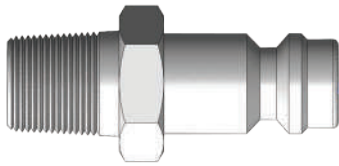

Medida	Serie-BR Niple Intercambio Serie-21 (Rosca Macho)							
	Detalle			Medida		DE Máximo		Hex Pulg
	# de Parte	Roscas	Material	Pulg	mm	Pulg	mm	
1/8"	BR1M1-B-E-7	1/8" - 27 NPT	latón	1.06	26.9	0.65	16.5	9/16"
	BR1GM1-B-E-7	1/8" - 28 BSPP	latón	1.06	26.9	0.65	16.5	9/16"
	BR1M2-B-E-7	1/4" - 18 NPT	latón	1.20	30.5	0.72	18.3	5/8"
	BR1GM2-B-E-7	1/4" - 19 BSPP	latón	1.20	30.5	0.72	18.3	5/8"

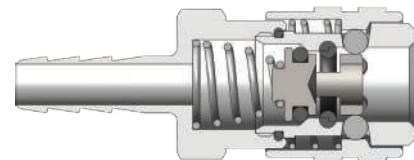
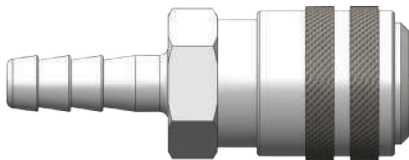

Medida	Serie-BR Cople Intercambio Serie-21 (Barbas para Manguera)							
	Detalle			Medida		DE Máximo		Hex Pulg
	# de Parte	DI Manguera	Material	Pulg	mm	Pulg	mm	
1/8"	1BRS1.25-B-7	4mm	latón	1.26	32.0	0.35	8.9	9/16"
	1BRS1.86-B-7	6mm	latón	1.26	32.0	0.35	8.9	9/16"
	1BRS2.83-B-7	9mm	latón	1.26	32.0	0.35	8.9	9/16"

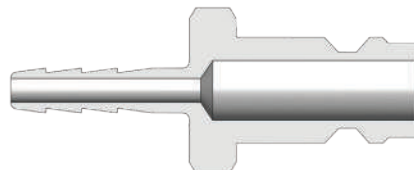
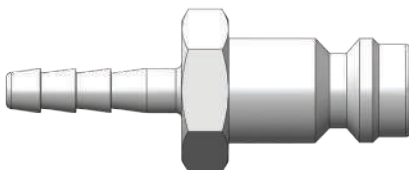

Medida	Serie-BR Niple Intercambio Serie-21 (Barbas para Manguera)							
	Detalle			Medida		DE Máximo		Hex Pulg
	# de Parte	DI Manguera	Material	Pulg	mm	Pulg	mm	
1/8"	BR1S1.25-B-E-7	4mm	latón	1.26	32.0	0.35	8.9	9/16"
	BR1S1.86-B-E-7	6mm	latón	1.26	32.0	0.35	8.9	9/16"
	BR1S2.83-B-E-7	9mm	latón	1.26	32.0	0.35	8.9	9/16"

Información de Intercambio

- El acople rápido para astronáutica Dixon

Materiales

- Los componentes son maquinados con barras sólidas de acero o latón.
- Resortes de acero inoxidable, balines y anillo de retención de acero al carbón.
- Los componentes de acero son platinados con cromo trivalente y cumplen con la norma ROHS
- Los coples se construyen de latón con válvulas de acero como estándar

Componentes del Sello

- Sellos de Nitrilo (Buna-N) estándar brindan un rango de temperatura de **-40°F a 250°F (-40°C a 121°C)**



Tabla de Presión Nominal

Medida	Serie-A Compacta (Conectado)							
	Cople Latón/Niple Acero				Cople/Niple Latón			
	Trabajo Máximo		Reventón		Trabajo Máximo		Reventón	
	PSI	Bar	PSI	Bar	PSI	Bar	PSI	Bar
1/8"	1,000	70	18,500	1,275	500	35	15,500	1,070
1/4"	1,000	70	8,000	550	500	35	6,500	450

Especificaciones Técnicas

Medida	Estándar Intercambiable				Parámetros Funcionales				
	Ejército USA	Gobierno USA	Estándar Internacional	Estándares ANSI/NFPA	Cantidad Balines	Inclusión de Aire	Pérdida de Flujo	Vacío	Flujo ΔP = 15 PSI
1/8"	-	-	-	-	3	N/A	N/A	N/R	8.6 CFM
1/4"	-	-	-	-	3	N/A	N/A	N/R	26 CFM

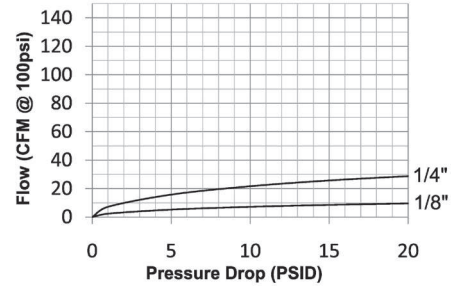
Opciones Disponibles

Medida	Opciones de Sello		Opciones de Válvula			Opciones de Manga		Tratamiento
	FKM	EPDM	Unvalved	Latón	Al 303	Bridado	Sleeve-Lock	Oxy-Clean
	Pre	Pre	Suf	Suf	Suf	Suf	Suf	Suf
1/8"	N/A	N/A	-E	-BV	-SV	N/A	-LS	-C1
1/4"	F-	P-	-E	N/A	N/A	N/A	-LS	-C1

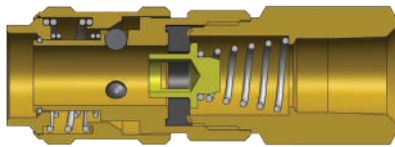

Serie-A Cople Compacto (Roscas Hembra)

Medida	Detalle							
	# de Parte	Roscas	Material	Medida		DE Máximo		Hex Pulg
				Pulg	mm	Pulg	mm	
1/8"	1AF1-B	1/8" - 27 NPTF	latón	1.68	42.7	0.64	16.3	1/2"
1/4"	2AF1-B	1/8" - 27 NPTF	latón	2.41	61.2	0.77	19.6	1/2"
	2AF2-B	1/4" - 18 NPTF	latón	2.70	68.6	0.77	19.6	11/16"

Coples Neumáticos: Serie-A

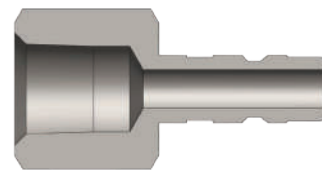

Serie-A Niple Compacto (Roscas Hembra)

Medida	Detalle			Medida		DE Máximo		Hex Pulg
	# de Parte	Roscas	Material	Pulg	mm	Pulg	mm	
1/8"	A1F1-B	1/8" - 27 NPTF	latón	1.26	32.0	0.58	14.7	1/2"
	A2F1-B	1/8" - 27 NPTF	latón	1.34	34.0	0.65	16.5	9/16"
1/4"	A2F2	1/4" - 18 NPTF	acero	1.56	39.6	0.79	20.1	11/16"
	A2F2-B	1/4" - 18 NPTF	latón	1.56	39.6	0.79	20.1	11/16"

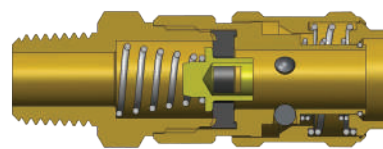
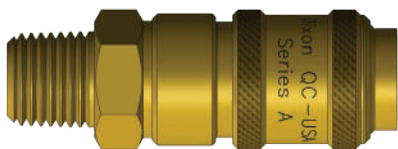

Serie-A Cople Compacto (Roscas Macho)

Medida	Detalle			Medida		DE Máximo		Hex Pulg
	# de Parte	Roscas	Material	Pulg	mm	Pulg	mm	
1/8"	1AM1-B	1/8" - 27 NPTF	latón	1.75	44.5	0.64	16.3	1/2"
1/4"	2AM1-B	1/8" - 27 NPTF	latón	2.12	53.8	0.77	19.6	11/16"
	2AM2-B	1/4" - 18 NPTF	latón	2.23	56.6	0.77	19.6	11/16"

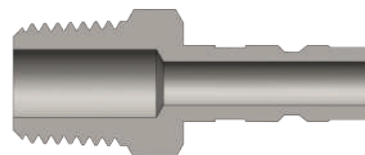

Serie-A Niple Compacto (Roscas Macho)

Medida	Detalle			Medida		DE Máximo		Hex Pulg
	# de Parte	Roscas	Material	Pulg	mm	Pulg	mm	
1/8"	A1M1-B	1/8" - 27 NPTF	latón	1.30	33.0	0.51	13.0	7/16"
1/4"	A2M2	1/4" - 18 NPTF	acero	1.59	40.4	0.65	16.5	9/16"
	A2M2-B	1/4" - 18 NPTF	latón	1.59	40.4	0.65	16.5	9/16"

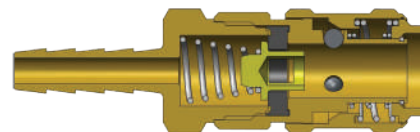
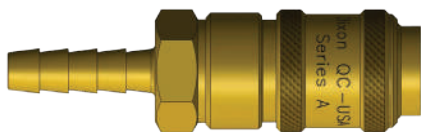

Serie-A Cople Compacto (Barbas para Manguera)

Medida	Detalle			Medida		DE Máximo		Hex Pulg
	# de Parte	DI Manguera	Material	Pulg	mm	Pulg	mm	
1/8"	1AS1-B	1/8"	latón	1.98	50.3	0.64	16.3	1/2"
1/4"	2AS2-B	1/4"	latón	2.70	68.6	0.77	19.6	11/16"

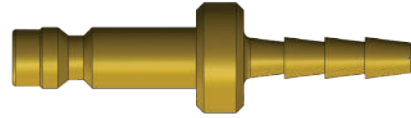
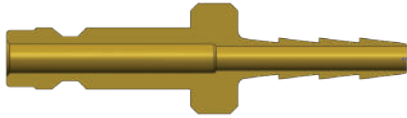

Medida	Serie-A Niple Compacto (Barbas para Manguera)							
	Detalle			Medida		DE Máximo		Hex Pulg
	# de Parte	DI Manguera	Material	Pulg	mm	Pulg	mm	
1/8"	A1S1-B	1/8"	latón	1.50	38.1	0.44	11.2	-
1/4"	A2S2	1/4"	acero	1.99	50.5	1.01	25.7	-

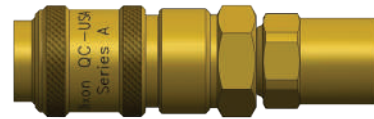
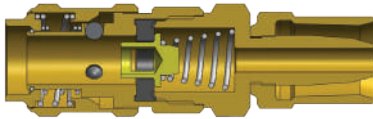

Medida	Serie-A Cople Compacto (Barbas Reutilizables)							
	Detalle			Medida		DE Máximo		Hex Pulg
	# de Parte	DI Manguera x DE	Material	Pulg	mm	Pulg	mm	
1/4"	2AE2-B	1/4" x 1/2"	latón	2.62	66.5	0.77	19.6	11/16"

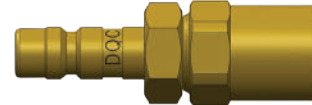
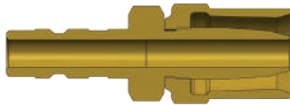

Medida	Serie-A Niple Compacto (Barbas Reutilizables)							
	Detalle			Medida		DE Máximo		Hex Pulg
	# de Parte	DI Manguera x DE	Material	Pulg	mm	Pulg	mm	
1/4"	A2E2	1/4" x 1/2"	acero	1.97	50.0	0.68	17.3	9/16"
	A2E2-B	1/4" x 1/2"	latón	1.97	50.0	0.68	17.3	9/16"

Perfil Serie-A

Medida	A	B
1/8"	0.22	0.11
1/4"	0.32	0.20

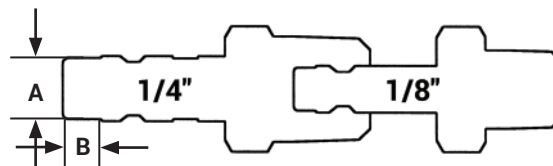

! La presión operativa de los acoples que utilizan las conexiones con extremos de barbas para manguera pueden ser dramáticamente reducidas al valor de la manguera y/o a la combinación con conexiones en los extremos. Consulte el catálogo del fabricante de manguera para obtener los valores de conexiones. Si tiene dudas, ponga a prueba bajo condiciones controladas aptas para su aplicación. Dixon Quick Coupling no asume responsabilidad por mala aplicación que resulte en paros de equipo, pérdida de producción y/o accidentes al personal incluyendo muerte.

Información de Intercambio

- Hansen Serie FS

Materiales

- Los componentes son maquinados con barras sólidas de latón.
- Stainless acero springs and roll-pins maximize corrosion resistance and extend service life

Componentes del Sello

- Sellos de Nitrilo (Buna-N) estándar brindan un rango de temperatura de **-40°F a 250°F (-40°C a 121°C)**

Características

- No previene el contraflujo
- El diseño para Flujo Alto da como resultado un máximo flujo con mínima caída de presión.
- Automática e instantáneamente protege al operador contra el latigazo de manguera en caso de que la manguera o el acople presente daños
- En caso de que la manguera se rompa o el acople falle, la válvula automáticamente se reinicia después que el problema se ha arreglado.
- Serie-SCV disponible en medidas grandes desde ¼" a 3", NPTF (roscas BSPP/BSPT bajo pedido).
- La operación de la válvula cumple completamente con las Regulaciones de Seguridad OSHA 1926.302(b)(7), como se muestra en la página 11.

 No se recomienda para aplicaciones que requieran 100% del suministro de aire. Estas aplicaciones incluyen, y no se limitan a, equipo de sand-blast, perforadoras y tuberías de expansión. Se recomienda que instale dispositivos de seguridad auxiliares para optimizar la seguridad del operador en el caso de un fallo de acople o ruptura de manguera.

Uso

- Las válvulas check de seguridad operan utilizando un diferencial de presión a través de la válvula para operar la válvula y el ensamble de resorte. La presión diferencial es directamente relativa al flujo de aire (SCFM) a través de la válvula.
- Cuando la presión diferencial se encuentra dentro de los límites de operación - debajo del flujo de corte - de la unidad, la fuerza de la válvula ejercida por el resorte es mayor que la causada por el diferencial de presión (vea la gráfica de posición abierta en la siguiente página). La válvula permanece abierta y la operación normal continua.
- Cuando la presión diferencial está por encima del límite de corte, la fuerza en la válvula ejercida por la presión diferencial es mayor a la fuerza ejercida por el resorte, la válvula se cierra (vea la gráfica de "posición cerrada" en la siguiente página).
- Cuando se haya realizado la reparación, la operación normal se permite automáticamente cuando la presión a través de la válvula se ecualiza mediante el agujero de purga.
- La medida del resorte de la válvula puede especificarse determinando el flujo de aire durante una operación normal y estimando el flujo de aire si una falla o ruptura ocurre.

Especificaciones Técnicas

Especificaciones de Desempeño	Presión de Operación Máxima - Bar (PSI)	Presión de Reventón Máxima - Bar (PSI)	Flujo de Aire ¹ 30.5m (100')
1/4"	24 (350)	138 (2,000)	17 SCFM
3/8"	24 (350)	138 (2,000)	41 SCFM
1/2"	24 (350)	138 (2,000)	77 SCFM
3/4"	24 (350)	138 (2,000)	178 SCFM
1"	24 (350)	138 (2,000)	340 SCFM
1-1/4"	24 (350)	138 (2,000)	620 SCFM
1-1/2"	24 (350)	138 (2,000)	940 SCFM
2"	24 (350)	138 (2,000)	1,760 SCFM
2-1/2"	24 (350)	138 (1,500)	2,800 SCFM
3"	24 (350)	138 (1,200)	4,200 SCFM

¹El valor del flujo de aire está basado en valores calculados utilizando flujo de aire sin obstrucciones para la medida de manguera aplicada.

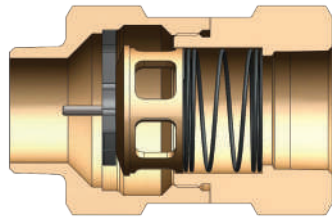

Abierta

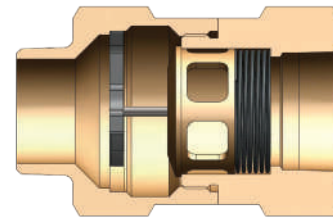

Cerrada

Medida	Serie-SCV Sensor de Flujo Excesivo (Rosca Macho a Hembra)			
	Detalle			Corte de flujo - SCFM ¹ (90 PSI Presión de Entrada)
	# de Parte	Roscas	Material	
1/4"	SCVL2	1/4" - 18 NPTF	latón	23-29
3/8"	SCVL3	3/8" - 18 NPTF	latón	30-36
	SCVM3	3/8" - 18 NPTF	latón	39-47
1/2"	SCVS3	3/8" - 18 NPTF	latón	52-65
	SCVM4	1/2" - 14 NPTF	latón	70-78
3/4"	SCVS4	1/2" - 14 NPTF	latón	80-96
	SCVL6	3/4" - 14 NPTF	latón	72-88
	SCVM6	3/4" - 14 NPTF	latón	92-108
	SCVR6	3/4" - 14 NPTF	latón	112-128
	SCVJ6	3/4" - 14 NPTF	latón	132-148
	SCVS6	3/4" - 14 NPTF	latón	160-180
1"	SCVH6	3/4" - 14 NPTF	latón	180-200
	SCVL8	1" - 11-1/2 NPTF	latón	165-195
	SCVM8	1" - 11-1/2 NPTF	latón	220-260
	SCVS8	1" - 11-1/2 NPTF	latón	280-320
1-1/4"	SCVH8	1" - 11-1/2 NPTF	latón	310-340
	SCVL10	1-1/4" - 11-1/2 NPTF	latón	260-290
	SCVM10	1-1/4" - 11-1/2 NPTF	latón	300-340
	SCVS10	1-1/4" - 11-1/2 NPTF	latón	440-500
1-1/2"	SCVH10	1-1/4" - 11-1/2 NPTF	latón	570-630
	SCVL12	1-1/2" - 11-1/2 NPTF	latón	300-360
	SCVM12	1-1/2" - 11-1/2 NPTF	latón	470-530
	SCVX12	1-1/2" - 11-1/2 NPTF	latón	564-602
2"	SCVS12	1-1/2" - 11-1/2 NPTF	latón	640-720
	SCVH12	1-1/2" - 11-1/2 NPTF	latón	750-830
	SCVL16	2" - 11-1/2 NPTF	latón	510-590
	SCVM16	2" - 11-1/2 NPTF	latón	725-825
3"	SCVS16	2" - 11-1/2 NPTF	latón	900-1050
	SCVH16	2" - 11-1/2 NPTF	latón	1100-1200
	SCVL24	3" - 11-1/2 NPTF	latón	1200-1400
3"	SCVS24	3" - 11-1/2 NPTF	latón	2400-2700
	SCVH24	3" - 11-1/2 NPTF	latón	2850-3050

¹Contacta a Dixon para los valores de las válvulas y otras presiones de entrada.

Coples Hidráulicos: Serie-H

Información de Intercambio

- Intercambiable con ISO7241 Serie B
- Parker Serie 60, Snap-Tite Serie 72, Hansen Serie HK, Faster Serie 'HNV' Eaton/Aeroquip FD45, Stucchi Serie IRB/IRBO/IRBX

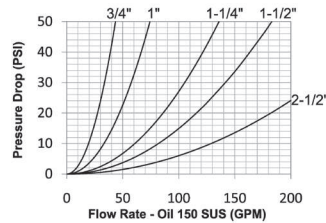
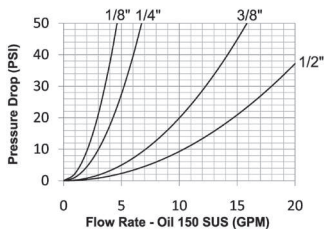

Materiales

- Los componentes son maquinados con barras sólidas de acero o latón, acero inox 303 o 316
- Balines, anillos de retención, y resortes de acero inoxidable que extienden la vida del servicio
- Los componentes de acero son platinados con cromo trivalente y cumplen con la norma ROHS
- Las mangas del cople de acero están endurecidas para resistir la deformación y extender la vida del servicio.
- Los nipples de acero se endurecen para brindar un desempeño para trabajo pesado y resistir deformaciones

Componentes del Sello

- Sellos de Nitrilo (Buna-N) estándar brindan un rango de temperatura de **-40°F a 250°F (-40°C a 121°C)**
- Acoples de 1/8" a 1" tienen un O-ring con anillo de refuerzo PTFE y en medidas 1-1/4" a 2-1/2" tienen un anillo Hytrel
- Sellos de válvula de 1/4" a 1" son crimpados en su lugar para mantener la integridad durante condiciones excesivas de flujo continuo y conexión presurizada.

Tabla de Presión Nominal

Medida	Serie-H Intercambio ISO-B (Conectado)															
	Cople/Niple Acero				Cople/Niple Latón				Cople/Niple A.I. 303				Cople/Niple A.I. 316			
	Max. Trabajo		Reventón		Max. Trabajo		Reventón		Max. Trabajo		Reventón		Max. Trabajo		Reventón	
	PSI	Bar	PSI	Bar	PSI	Bar	PSI	Bar	PSI	Bar	PSI	Bar	PSI	Bar	PSI	Bar
1/8"	4,000	275	14,500	1,000	3,000	200	16,500	1,100	3,625	250	29,500	2,000	3,625	250	29,500	2,000
1/4"	5,000	345	22,500	1,550	3,000	200	15,000	1,000	3,625	250	31,500	2,150	3,625	250	33,000	2,200
3/8"	4,000	275	16,500	1,150	3,000	200	12,000	800	3,625	250	26,500	1,800	3,625	250	28,000	1,900
1/2"	4,000	275	16,000	1,100	2,500	175	11,500	750	3,625	250	27,500	1,900	3,625	250	22,000	1,500
3/4"	4,000	275	16,500	1,150	2,000	138	12,000	800	3,000	200	16,000	1,100	3,000	200	21,500	1,450
1"	4,000	275	16,000	1,100	1,500	100	8,500	600	2,000	138	15,000	1,000	2,000	138	15,000	1,000
1-1/4"	2,500	170	10,000	700	1,000	70	6,500	450	2,000	138	10,000	700	1,000	70	8,500	580
1-1/2"	2,500	170	12,500	850	1,000	70	6,500	450	1,500	100	8,500	580	1,000	70	7,000	480
2-1/2"	1,500	100	6,000	400	700	50	5,500	380	1,000	70	6,500	450	900	62	6,000	400

Especificaciones Técnicas

Medida	Estándar Intercambiable				Parámetros Funcionales				
	Ejército USA	Gobierno USA	Estándar Internacional	Estándares ANSI/NFPA	Cantidad Balines	Inclusión de Aire	Pérdida de Flujo	Vacío Pulg HG	Flujo ΔP = 22 PSI
1/8"	-	-	ISO7241 B	-	8	0.6cc	0.3cc	27.4	3.1 GPM
1/4"	-	-	ISO7241 B	-	8	1.1cc	0.9cc	27.4	4.5 GPM
3/8"	-	-	ISO7241 B	-	9	2.6cc	1.8cc	27.4	12 GPM
1/2"	-	-	ISO7241 B	-	9	3.8cc	2.9cc	27.4	18 GPM
3/4"	-	-	ISO7241 B	-	12	10.8cc	9.7cc	27.4	29 GPM
1"	-	-	ISO7241 B	-	12	15.9cc	15.3cc	27.4	50 GPM
1-1/4"	-	-	ISO7241 B	-	12	30.0cc	45.0cc	N/R	90 GPM
1-1/2"	-	-	ISO7241 B	-	12	60.0cc	75.0cc	N/R	120 GPM
2-1/2"	-	-	ISO7241 B	-	15	N/A	N/A	N/R	195 GPM

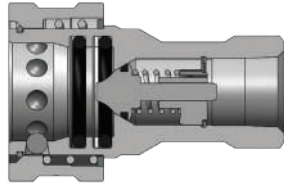

Medida	Serie-H Cople Intercambio ISO-B (Roscas Hembra)							
	Detalle			Medida		DE Máximo		Hex Pulg
	# de Parte	Roscas	Material	Pulg	mm	Pulg	mm	
1/8"	1HF1	1/8" - 27 NPTF	acero	1.90	48.3	0.93	23.6	9/16"
	1HF1-B	1/8" - 27 NPTF	latón	1.90	48.3	0.93	23.6	9/16"
	1HF1-S	1/8" - 27 NPTF	A.I. 303	1.90	48.3	0.93	23.6	9/16"
	1HF1-SS	1/8" - 27 NPTF	A.I. 316	1.90	48.3	0.93	23.6	9/16"
	1HOF2	7/16" - 20 ORB	acero	1.90	48.3	0.93	23.6	9/16"
1/4"	2HF2	1/4" - 18 NPTF	acero	2.26	57.4	1.12	28.4	7/8"
	2HF2-B	1/4" - 18 NPTF	latón	2.26	57.4	1.12	28.4	7/8"
	2HF2-S	1/4" - 18 NPTF	A.I. 303	2.26	57.4	1.12	28.4	7/8"
	2HF2-SS	1/4" - 18 NPTF	A.I. 316	2.26	57.4	1.12	28.4	3/4"
	2HBF2	1/4" - 19 BSPP	acero	2.26	57.4	1.12	28.4	7/8"
	2HBF2-B	1/4" - 19 BSPP	latón	2.26	57.4	1.12	28.4	7/8"
	2HBF2-S	1/4" - 19 BSPP	A.I. 303	2.26	57.4	1.12	28.4	7/8"
	2HBF2-SS	1/4" - 19 BSPP	A.I. 316	2.26	57.4	1.12	28.4	3/4"
3/8"	2HOF3	9/16" - 18 ORB	acero	2.29	58.2	1.12	28.4	13/16"
	3HF3	3/8" - 18 NPTF	acero	2.51	63.8	1.42	36.1	1-1/16"
	3HF3-B	3/8" - 18 NPTF	latón	2.51	63.8	1.42	36.1	1-1/16"
	3HF3-S	3/8" - 18 NPTF	A.I. 303	2.51	63.8	1.42	36.1	1-1/16"
	3HF3-SS	3/8" - 18 NPTF	A.I. 316	2.51	63.8	1.42	36.1	7/8"
	3HBF3	3/8" - 19 BSPP	acero	2.51	63.8	1.42	36.1	1-1/16"
	3HBF3-B	3/8" - 19 BSPP	latón	2.51	63.8	1.42	36.1	1-1/16"
	3HBF3-S	3/8" - 19 BSPP	A.I. 303	2.51	63.8	1.42	36.1	1-1/16"
	3HBF3-SS	3/8" - 19 BSPP	A.I. 316	2.51	63.8	1.42	36.1	7/8"
	3HOF4	3/4" - 16 ORB	acero	2.62	66.5	1.42	36.1	1"
1/2"	4HF4	1/2" - 14 NPTF	acero	2.86	72.6	1.86	47.2	1-5/16"
	4HF4-B	1/2" - 14 NPTF	latón	2.86	72.6	1.86	47.2	1-5/16"
	4HF4-S	1/2" - 14 NPTF	A.I. 303	2.86	72.6	1.86	47.2	1-5/16"
	4HF4-SS	1/2" - 14 NPTF	A.I. 316	2.86	72.6	1.86	47.2	1-1/16"
	4HBF4	1/2" - 14 BSPP	acero	2.86	72.6	1.86	47.2	1-5/16"
	4HBF4-B	1/2" - 14 BSPP	latón	2.86	72.6	1.86	47.2	1-5/16"
	4HBF4-S	1/2" - 14 BSPP	A.I. 303	2.86	72.6	1.86	47.2	1-5/16"
	4HBF4-SS	1/2" - 14 BSPP	A.I. 316	2.86	72.6	1.86	47.2	1-1/16"
3/4"	4HOF5	7/8" - 14 ORB	acero	2.90	73.7	1.86	47.2	1-1/8"
	6HF6	3/4" - 14 NPTF	acero	3.55	90.2	2.22	56.4	1-5/16"
	6HF6-B	3/4" - 14 NPTF	latón	3.55	90.2	2.22	56.4	1-5/16"
	6HF6-S	3/4" - 14 NPTF	A.I. 303	3.55	90.2	2.22	56.4	1-5/16"
	6HF6-SS	3/4" - 14 NPTF	A.I. 316	3.55	90.2	2.22	56.4	1-5/16"
	6HBF6	3/4" - 14 BSPP	acero	3.55	90.2	2.22	56.4	1-5/16"
	6HBF6-B	3/4" - 14 BSPP	latón	3.55	90.2	2.22	56.4	1-5/16"
	6HBF6-S	3/4" - 14 BSPP	A.I. 303	3.55	90.2	2.22	56.4	1-5/16"
1"	6HBF6-SS	3/4" - 14 BSPP	A.I. 316	3.55	90.2	2.22	56.4	1-5/16"
	6HOF6	1-1/16" - 12 ORB	acero	3.69	93.7	2.22	56.4	1-5/16"
	8HF8	1" - 11-1/2 NPTF	acero	4.13	104.9	2.49	63.2	1-5/8"
	8HF8-B	1" - 11-1/2 NPTF	latón	4.13	104.9	2.49	63.2	1-5/8"
	8HF8-S	1" - 11-1/2 NPTF	A.I. 303	4.13	104.9	2.49	63.2	1-5/8"
	8HF8-SS	1" - 11-1/2 NPTF	A.I. 316	4.13	104.9	2.49	63.2	1-5/8"
	8HBF8	1" - 11 BSPP	acero	4.13	104.9	2.49	63.2	1-5/8"
	8HBF8-B	1" - 11 BSPP	latón	4.13	104.9	2.49	63.2	1-5/8"
	8HBF8-S	1" - 11 BSPP	A.I. 303	4.13	104.9	2.49	63.2	1-5/8"
	8HBF8-SS	1" - 11 BSPP	A.I. 316	4.13	104.9	2.49	63.2	1-5/8"
	8HOF8	1-5/16" - 12 ORB	acero	4.19	106.3	2.49	63.2	1-5/8"

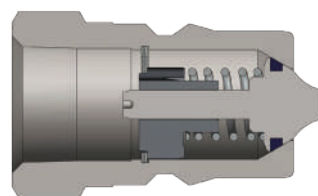

Serie-H Niple Intercambio ISO-B (Roscas Hembra)

Medida	Detalle			Medida		DE Máximo		Hex Pulg
	# de Parte	Roscas	Material	Pulg	mm	Pulg	mm	
1/8"	H1F1	1/8" - 27 NPTF	acero	1.28	32.5	0.65	16.5	9/16"
	H1F1-B	1/8" - 27 NPTF	latón	1.28	32.5	0.65	16.5	9/16"
	H1F1-S	1/8" - 27 NPTF	A.I. 303	1.28	32.5	0.65	16.5	9/16"
	H1F1-SS	1/8" - 27 NPTF	A.I. 316	1.28	32.5	0.65	16.5	9/16"
	H1OF2	7/16" - 20 ORB	acero	1.28	32.5	0.65	16.5	9/16"
1/4"	H2F2	1/4" - 18 NPTF	acero	1.55	39.4	0.83	21.1	3/4"
	H2F2-B	1/4" - 18 NPTF	latón	1.55	39.4	0.83	21.1	3/4"
	H2F2-S	1/4" - 18 NPTF	A.I. 303	1.55	39.4	0.83	21.1	3/4"
	H2F2-SS	1/4" - 18 NPTF	A.I. 316	1.55	39.4	0.83	21.1	3/4"
	H2BF2	1/4" - 19 BSPP	acero	1.55	39.4	0.83	21.1	3/4"
	H2BF2-B	1/4" - 19 BSPP	latón	1.55	39.4	0.83	21.1	3/4"
	H2BF2-S	1/4" - 19 BSPP	A.I. 303	1.55	39.4	0.83	21.1	3/4"
	H2BF2-SS	1/4" - 19 BSPP	A.I. 316	1.55	39.4	0.83	21.1	3/4"
	H2OF3	9/16" - 18 ORB	acero	1.61	40.9	0.90	22.9	13/16"
3/8"	H3F3	3/8" - 18 NPTF	acero	1.70	43.2	0.97	24.6	7/8"
	H3F3-B	3/8" - 18 NPTF	latón	1.70	43.2	0.97	24.6	7/8"
	H3F3-S	3/8" - 18 NPTF	A.I. 303	1.70	43.2	0.97	24.6	7/8"
	H3F3-SS	3/8" - 18 NPTF	A.I. 316	1.70	43.2	0.97	24.6	7/8"
	H3BF3	3/8" - 19 BSPP	acero	1.70	43.2	0.97	24.6	7/8"
	H3BF3-B	3/8" - 19 BSPP	latón	1.70	43.2	0.97	24.6	7/8"
	H3BF3-S	3/8" - 19 BSPP	A.I. 303	1.70	43.2	0.97	24.6	7/8"
1/2"	H4F4	1/2" - 14 NPTF	acero	1.94	49.3	1.17	29.7	1-1/16"
	H4F4-B	1/2" - 14 NPTF	latón	1.94	49.3	1.17	29.7	1-1/16"
	H4F4-S	1/2" - 14 NPTF	A.I. 303	1.94	49.3	1.17	29.7	1-1/16"
	H4F4-SS	1/2" - 14 NPTF	A.I. 316	1.94	49.3	1.17	29.7	1-1/16"
	H4BF4	1/2" - 14 BSPP	acero	1.94	49.3	1.17	29.7	1-1/16"
	H4BF4-B	1/2" - 14 BSPP	latón	1.94	49.3	1.17	29.7	1-1/16"
	H4BF4-S	1/2" - 14 BSPP	A.I. 303	1.94	49.3	1.17	29.7	1-1/16"
	H4BF4-SS	1/2" - 14 BSPP	A.I. 316	1.94	49.3	1.17	29.7	1-1/16"
	H4OF5	7/8" - 14 ORB	acero	1.94	49.3	1.24	31.5	1-1/8"
3/4"	H6F6	3/4" - 14 NPTF	acero	2.44	61.2	1.50	36.6	1-3/8"
	H6F6-B	3/4" - 14 NPTF	latón	2.44	61.2	1.50	36.6	1-3/8"
	H6F6-S	3/4" - 14 NPTF	A.I. 303	2.44	61.2	1.50	36.6	1-3/8"
	H6F6-SS	3/4" - 14 NPTF	A.I. 316	2.44	61.2	1.50	36.6	1-3/8"
	H6BF6	3/4" - 14 BSPP	acero	2.44	61.2	1.50	36.6	1-3/8"
	H6BF6-B	3/4" - 14 BSPP	latón	2.44	61.2	1.50	36.6	1-3/8"
	H6BF6-S	3/4" - 14 BSPP	A.I. 303	2.44	61.2	1.50	36.6	1-3/8"
	H6BF6-SS	3/4" - 14 BSPP	A.I. 316	2.44	61.2	1.50	36.6	1-3/8"
	H6OF6	1-1/16" - 12 ORB	acero	2.58	61.2	1.50	36.6	1-3/8"
1"	H8F8	1" - 11-1/2 NPTF	acero	2.87	72.9	1.79	45.5	1-5/8"
	H8F8-B	1" - 11-1/2 NPTF	latón	2.87	72.9	1.79	45.5	1-5/8"
	H8F8-S	1" - 11-1/2 NPTF	A.I. 303	2.87	72.9	1.79	45.5	1-5/8"
	H8F8-SS	1" - 11-1/2 NPTF	A.I. 316	2.87	72.9	1.79	45.5	1-5/8"
	H8BF8	1" - 11 BSPP	acero	2.87	72.9	1.79	45.5	1-5/8"
	H8BF8-B	1" - 11 BSPP	latón	2.87	72.9	1.79	45.5	1-5/8"
	H8BF8-S	1" - 11 BSPP	A.I. 303	2.87	72.9	1.79	45.5	1-5/8"
	H8BF8-SS	1" - 11 BSPP	A.I. 316	2.87	72.9	1.79	45.5	1-5/8"
	H8OF8	1-5/16" - 12 ORB	acero	2.87	72.9	1.79	45.5	1-5/8"

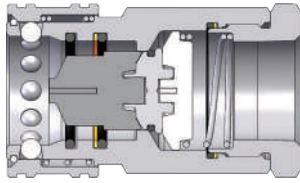

Medida	Serie-H Cople Intercambio ISO-B Volumen Alto (Roscas Hembra)							
	Detalle			Medida		DE Máximo		Hex Pulg
	# de Parte	Roscas	Material	Pulg	mm	Pulg	mm	
1-1/4"	10HF10	1-1/4" - 11-1/2 NPTF	acero	4.43	112.5	2.60	66.0	2-3/8"
	10HF10-B	1-1/4" - 11-1/2 NPTF	latón	4.43	112.5	2.60	66.0	2-3/8"
	10HF10-S	1-1/4" - 11-1/2 NPTF	A.I. 303	4.43	112.5	2.60	66.0	2-3/8"
	10HF10-SS	1-1/4" - 11-1/2 NPTF	A.I. 316	4.43	112.5	2.60	66.0	2-3/8"
	10HBF10	1-1/4" - 11 BSPP	acero	4.43	112.5	2.60	66.0	2-3/8"
	10HBF10-B	1-1/4" - 11 BSPP	latón	4.43	112.5	2.60	66.0	2-3/8"
	10HBF10-S	1-1/4" - 11 BSPP	A.I. 303	4.43	112.5	2.60	66.0	2-3/8"
	10HBF10-SS	1-1/4" - 11 BSPP	A.I. 316	4.43	112.5	2.60	66.0	2-3/8"
1-1/2"	12HF10	1-1/4" - 11-1/2 NPTF	acero	4.81	122.2	3.00	76.2	2-5/8"
	12HF10-B	1-1/4" - 11-1/2 NPTF	latón	4.81	122.2	3.00	76.2	2-5/8"
	12HF10-S	1-1/4" - 11-1/2 NPTF	A.I. 303	4.81	122.2	3.00	76.2	2-5/8"
	12HF10-SS	1-1/4" - 11-1/2 NPTF	A.I. 316	4.81	122.2	3.00	76.2	2-5/8"
	12HOF10	1-5/8" - 12 ORB	acero	4.81	122.2	3.00	76.2	2-5/8"
	12HF12	1-1/2" - 11-1/2 NPTF	acero	4.81	122.2	3.00	76.2	2-5/8"
	12HF12-B	1-1/2" - 11-1/2 NPTF	latón	4.81	122.2	3.00	76.2	2-5/8"
	12HF12-S	1-1/2" - 11-1/2 NPTF	A.I. 303	4.81	122.2	3.00	76.2	2-5/8"
	12HF12-SS	1-1/2" - 11-1/2 NPTF	A.I. 316	4.81	122.2	3.00	76.2	2-5/8"
	12HBF12	1-1/2" - 11 BSPP	acero	4.81	122.2	3.00	76.2	2-5/8"
	12HBF12-B	1-1/2" - 11 BSPP	latón	4.81	122.2	3.00	76.2	2-5/8"
	12HBF12-S	1-1/2" - 11 BSPP	A.I. 303	4.81	122.2	3.00	76.2	2-5/8"
12HBF12-SS	1-1/2" - 11 BSPP	A.I. 316	4.81	122.2	3.00	76.2	2-5/8"	
12HOF12	1-7/8" - 12 ORB	acero	4.81	122.2	3.00	76.2	2-5/8"	
2-1/2"	20HF16	2" - 11-1/2 NPTF	acero	5.57	141.5	4.10	104.1	3-3/4"
	20HF16-B	2" - 11-1/2 NPTF	latón	5.57	141.5	4.10	104.1	3-3/4"
	20HF20	2-1/2" - 8 NPTF	acero	6.04	153.4	4.10	104.1	3-3/4"
	20HF24	3" - 8 NPTF	acero	6.96	176.8	4.35	110.5	4"

Coples Hidráulicos: Serie-H

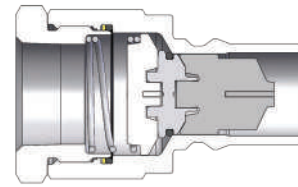
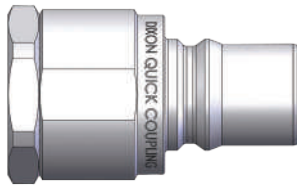

Medida	Serie-H Cople Intercambio ISO-B Alto Volumen (Roscas Hembra)							
	Detalle			Medida		DE Máximo		Hex Pulg
	# de Parte	Roscas	Material	Pulg	mm	Pulg	mm	
1-1/4"	H10F10	1-1/4" - 11-1/2 NPTF	acero	4.25	108.0	2.60	66.0	2-3/8"
	H10F10-B	1-1/4" - 11-1/2 NPTF	latón	4.25	108.0	2.60	66.0	2-3/8"
	H10F10-S	1-1/4" - 11-1/2 NPTF	A.I. 303	4.25	108.0	2.60	66.0	2-3/8"
	H10F10-SS	1-1/4" - 11-1/2 NPTF	A.I. 316	4.25	108.0	2.60	66.0	2-3/8"
	H10BF10	1-1/4" - 11-BSPP	acero	4.25	108.0	2.60	66.0	2-3/8"
	H10BF10-B	1-1/4" - 11-BSPP	latón	4.25	108.0	2.60	66.0	2-3/8"
	H10BF10-S	1-1/4" - 11-BSPP	A.I. 303	4.25	108.0	2.60	66.0	2-3/8"
	H10BF10-SS	1-1/4" - 11-BSPP	A.I. 316	4.25	108.0	2.60	66.0	2-3/8"
1-1/2"	H12F10	1-1/4" - 11-1/2 NPTF	acero	4.76	120.9	2.88	73.2	2-5/8"
	H12F10-B	1-1/4" - 11-1/2 NPTF	latón	4.76	120.9	2.88	73.2	2-5/8"
	H12F10-S	1-1/4" - 11-1/2 NPTF	A.I. 303	4.76	120.9	2.88	73.2	2-5/8"
	H12F10-SS	1-1/4" - 11-1/2 NPTF	A.I. 316	4.76	120.9	2.88	73.2	2-5/8"
	H120F10	1-5/8" - 12 ORB	acero	4.76	120.9	2.88	73.2	2-5/8"
	H12F12	1-1/2" - 11-1/2 NPTF	acero	4.76	120.9	2.88	73.2	2-5/8"
	H12F12-B	1-1/2" - 11-1/2 NPTF	latón	4.76	120.9	2.88	73.2	2-5/8"
	H12F12-S	1-1/2" - 11-1/2 NPTF	A.I. 303	4.76	120.9	2.88	73.2	2-5/8"
	H12F12-SS	1-1/2" - 11-1/2 NPTF	A.I. 316	4.76	120.9	2.88	73.2	2-5/8"
	H12BF12	1-1/2" - 11 BSPP	acero	4.76	120.9	2.88	73.2	2-5/8"
	H12BF12-B	1-1/2" - 11 BSPP	latón	4.76	120.9	2.88	73.2	2-5/8"
	H12BF12-S	1-1/2" - 11 BSPP	A.I. 303	4.76	120.9	2.88	73.2	2-5/8"
	H12BF12-SS	1-1/2" - 11 BSPP	A.I. 316	4.76	120.9	2.88	73.2	2-5/8"
	H120F12	1-7/8" - 12 ORB	acero	4.76	120.9	2.88	73.2	2-5/8"
2-1/2"	H20F16	2" - 11-1/2 NPTF	acero	5.48	139.2	4.10	104.1	3-3/4"
	H20F16-B	2" - 11-1/2 NPTF	latón	5.48	139.2	4.10	104.1	3-3/4"
	H20F20	2-1/2" - 8 NPTF	acero	5.95	151.1	4.10	104.1	3-3/4"
	H20F24	3" - 8 NPTF	acero	6.87	174.5	4.35	110.5	4"

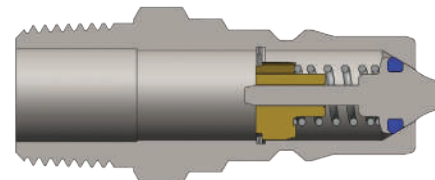

Medida	Serie-H Niple Intercambio ISO-B (Roscas Macho)							
	Detalle			Medida		DE Máximo		Hex Pulg
	# de Parte	Roscas	Material	Pulg	mm	Pulg	mm	
1/4"	H2M3	3/8" - 18 NPTF	acero	2.03	51.6	0.83	21.1	3/4"
1/2"	H4M6-S	3/4" - 14 NPTF	A.I. 303	2.13	58.7	1.17	29.7	1-1/16"

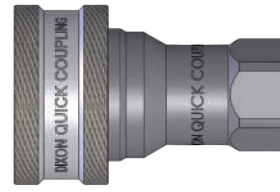
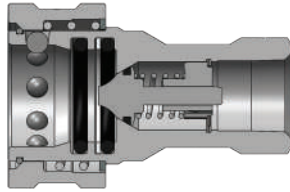

Medida	Serie-H Cople ISO-B "Puerta Deslizante" Horno de Acero (Roscas Hembra)							
	Detalle			Medida		DE Máximo		Hex Pulg
	# de Parte	Roscas	Material	Pulg	mm	Pulg	mm	
1/2"	4HF4-HV	1/2" - 14 NPTF	acero	2.86	72.6	1.86	47.2	1-1/16"
	F-4HF4-HV	1/2" - 14 NPTF	acero	2.86	72.60	1.86	47.20	1-1/16"

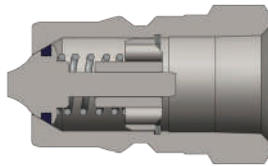

Medida	Serie-H Niple ISO-B "Puerta Deslizante" Horno de Acero (Roscas Hembra)							
	Detalle			Medida		DE Máximo		Hex Pulg
	# de Parte	Roscas	Material	Pulg	mm	Pulg	mm	
1/2"	H4F4-HV	1/2" - 14 NPTF	acero	1.94	49.3	1.17	29.7	1-1/16"
	F-H4F4-HV	1/2" - 14 NPTF	acero	1.94	49.30	1.17	29.70	1-1/16"

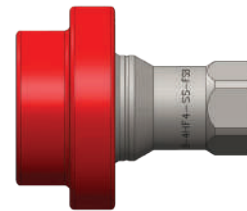
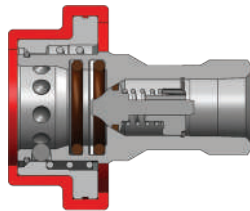

Medida	Serie-H Cople Intercambio ISO-B Brida de Silicón para Aceite (Roscas Hembra)							
	Detalle			Medida		DE Máximo		Hex Pulg
	# de Parte	Roscas	Material	Pulg	mm	Pulg	mm	
1/2"	D-4HF4-S-FSB	1/2" - 14 NPTF	A.I. 303	2.86	72.6	2.52	64.0	1-1/16"
	D-4HF4-SS-FSB	1/2" - 14 NPTF	A.I. 316	2.86	72.6	2.52	64.0	1-1/16"

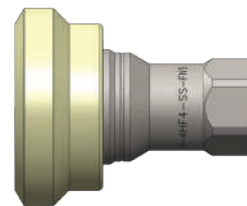
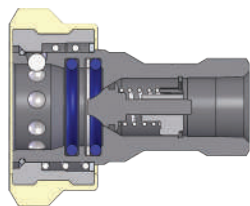

Medida	Serie-H Cople Intercambio ISO-B Brida de Nailon para Aceite (Roscas Hembra)							
	Detalle			Medida		DE Máximo		Hex Pulg
	# de Parte	Roscas	Material	Pulg	mm	Pulg	mm	
1/2"	D-4HF4-S-FNS	1/2" - 14 NPTF	A.I. 303	2.86	72.6	2.38	60.5	1-1/16"
	D-4HF4-SS-FNS	1/2" - 14 NPTF	A.I. 316	2.86	72.6	2.38	60.5	1-1/16"

Coples Hidráulicos: Serie-H

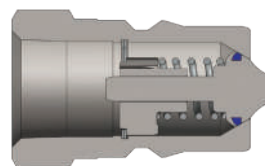

Serie-H Niple ISO-B para Aceite (Roscas Hembra)

Medida	Detalle			Medida		DE Máximo		Hex Pulg
	# de Parte	Roscas	Material	Pulg	mm	Pulg	mm	
1/2"	D-H4F4-SV-8	1/2" - 14 NPTF	acero	1.94	49.3	1.17	29.7	1-1/16"
	D-H4F4-S	1/2" - 14 NPTF	A.I. 303	1.94	49.3	1.17	29.7	1-1/16"
	D-H4F4-SS	1/2" - 14 NPTF	A.I. 316	1.94	49.3	1.17	29.7	1-1/16"

Opciones Disponibles

Medida	Opciones de Sello Estándar								Kalrez® Opciones de Sello		
	FKM	EPDM	Steam-EP	FDA FKM	Mil-Nitrilo	Fuel Nitrilo	PTFE	Silicón	4079	6375	7075
1/8"	F-	P-	N/A	N/A	N/A	N/A	N/A	N/A	K4-	K6-	K7-
1/4"	F-	P-	PS-	D-	M-	JF-	TS-	S-	K4-	K6-	K7-
3/8"	F-	P-	PS-	D-	M-	JF-	TS-	S-	K4-	K6-	K7-
1/2"	F-	P-	PS-	D-	M-	JF-	TS-	S-	K4-	K6-	K7-
3/4"	F-	P-	PS-	D-	M-	JF-	TS-	S-	K4-	K6-	K7-
1"	F-	P-	PS-	D-	M-	JF-	TS-	S-	K4-	K6-	K7-
1-1/4"	F-	P-	PS-	D-	M-	JF-	N/A	S-	K4-	K6-	K7-
1-1/2"	F-	P-	PS-	D-	M-	JF-	N/A	S-	K4-	K6-	K7-
2-1/2"	N/A	N/A	N/A	N/A	N/A	N/A	N/A	N/A	N/A	N/A	N/A

Medida	Opciones de Válvula						Opciones de Manga			Tratamiento
	Sin válvula	Actuador	Acero	Latón	Al 303	Al 316	Manga de Seguridad	Bridado	Brida Silicón	Oxy-Clean
1/8"	-E	N/A	-ZV	-BV	N/A	N/A	-LS	N/A	N/A	-C1
1/4"	-E	-VA	-ZV	-BV	-SV	SSV	-LS	-FS	N/A	-C1
3/8"	-E	-VA	-ZV	-BV	-SV	SSV	-LS	-FS	N/A	-C1
1/2"	-E	-VA	-ZV	-BV	-SV	SSV	-LS	-FS	FSB	-C1
3/4"	-E	-VA	-ZV	-BV	-SV	SSV	-LS	-FS	N/A	-C1
1"	-E	-VA	-ZV	-BV	-SV	SSV	-LS	-FS	N/A	-C1
1-1/4"	-E	N/A	-ZV	-BV	-SV	SSV	-LS	N/A	N/A	-C1
1-1/2"	-E	N/A	-ZV	-BV	-SV	SSV	-LS	N/A	N/A	-C1
2-1/2"	N/A	N/A	N/A	N/A	N/A	N/A	N/A	N/A	N/A	N/A

¹ actuador de válvula de latón

Perfil Serie-H

Medida	A	B
1/8"	0.43	0.32
1/4"	0.56	0.39
3/8"	0.48	0.50
1/2"	0.92	0.49
3/4"	1.24	0.75
1"	1.49	0.82
1-1/4"	1.49	1.13
1-1/2"	1.75	1.29
2-1/2"	2.50	1.50

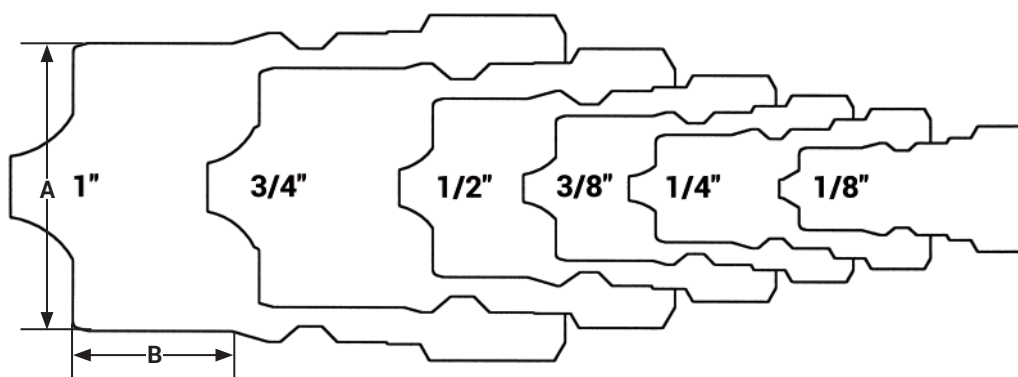



Medida	Serie-H Tapas y Tapones Intercambio ISO-B			
	Detalle			Material
	Tapa de Cople	Tapa de Niple		
1/8"	1HDP	H1DC		nitrilo
1/4"	2HDP-H2DC combo niple/tapa			nitrilo
3/8"	3HDP-H3DC combo niple/tapa			nitrilo
1/2"	4HDP-H4DC combo niple/tapa			nitrilo
3/4"	6HDP-H6DC combo niple/tapa			nitrilo
1"	8HDP-H8DC combo niple/tapa ¹			nitrilo

¹8HDP-H8DC embona en medidas 1" y 1-1/4"



Medida	Serie-H Tapón para Acople Intercambio ISO-B			
	Detalle			Cuerpo
	# de Parte	Cordón		
1/4"	2HDP-A	cable de acero		aluminio
3/8"	3HDP-A	cable de acero		aluminio
1/2"	4HDP-A	cable de acero		aluminio
3/4"	6HDP-A	cable de acero		aluminio
1"	8HDP-A	cable de acero		aluminio
1-1/2"	12HDP-A	cable de acero		aluminio
2-1/2"	20HDP-A	cable de acero		aluminio

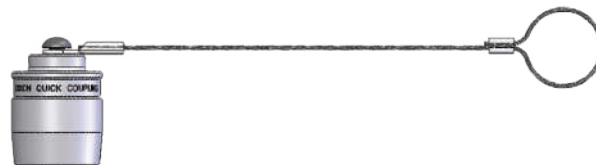

Medida	Serie-H Tapón para Niple Intercambio ISO-B				
	Detalle			Cantidad del Paquete	
	# de Parte	Cordón	Cuerpo	Bolsa	Caja
1/4"	H2DC-A	cable de acero	aluminio	10	50
3/8"	H3DC-A	cable de acero	aluminio	10	50
1/2"	H4DC-A	cable de acero	aluminio	10	50
3/4"	H6DC-A	cable de acero	aluminio	5	25
1"	H8DC-A	cable de acero	aluminio	5	25
1-1/2"	H12DC-A	cable de acero	aluminio	-	10
2-1/2"	H20DC-A	cable de acero	aluminio	-	5

Medida	Serie-H Kit de sellos para Cople ISO-B			
	Detalle			Contenido de Kit de Sellos
	# de Parte	Estilo de Cople	Material de Sello	
1/8"	1H-SKIT	acero, Al 303, Al 316, latón	nitrilo	dos O-rings y un anillo PTFE anti-extrusión
	F-1H-SKIT	acero, Al 303, Al 316, latón	FKM	dos O-rings y un anillo PTFE anti-extrusión
	P-1H-SKIT	acero, Al 303, Al 316, latón	EPDM	dos O-rings y un anillo PTFE anti-extrusión
1/4"	2H-SKIT	acero, Al 303, Al 316, latón	nitrilo	dos O-rings y un anillo PTFE anti-extrusión
	F-2H-SKIT	acero, Al 303, Al 316, latón	FKM	dos O-rings y un anillo PTFE anti-extrusión
	P-2H-SKIT	acero, Al 303, Al 316, latón	EPDM	dos O-rings y un anillo PTFE anti-extrusión
3/8"	3H-SKIT	acero, Al 303, Al 316, latón	nitrilo	dos O-rings y un anillo PTFE anti-extrusión
	F-3H-SKIT	acero, Al 303, Al 316, latón	FKM	dos O-rings y un anillo PTFE anti-extrusión
	P-3H-SKIT	acero, Al 303, Al 316, latón	EPDM	dos O-rings y un anillo PTFE anti-extrusión
1/2"	4H-SKIT	acero, Al 303, Al 316, latón	nitrilo	dos O-rings y un anillo PTFE anti-extrusión
	F-4H-SKIT	acero, Al 303, Al 316, latón	FKM	dos O-rings y un anillo PTFE anti-extrusión
	P-4H-SKIT	acero, Al 303, Al 316, latón	EPDM	dos O-rings y un anillo PTFE anti-extrusión
3/4"	6H-SKIT	acero, Al 303, Al 316, latón	nitrilo	dos O-rings y un anillo PTFE anti-extrusión
	F-6H-SKIT	acero, Al 303, Al 316, latón	FKM	dos O-rings y un anillo PTFE anti-extrusión
	P-6H-SKIT	acero, Al 303, Al 316, latón	EPDM	dos O-rings y un anillo PTFE anti-extrusión
1"	8H-SKIT	acero, Al 303, Al 316, latón	nitrilo	dos O-rings y un anillo PTFE anti-extrusión
	F-8H-SKIT	acero, Al 303, Al 316, latón	FKM	dos O-rings y un anillo PTFE anti-extrusión
	P-8H-SKIT	acero, Al 303, Al 316, latón	EPDM	dos O-rings y un anillo PTFE anti-extrusión
1-1/4"	10H-SKIT	acero, Al 303, Al 316, latón	nitrilo	O-ring de adaptador/válvula y dos O-ring para el cuerpo
	F-10-SKIT	acero, Al 303, Al 316, latón	FKM	O-ring de adaptador/válvula y dos O-ring para el cuerpo
	P-10-SKIT	acero, Al 303, Al 316, latón	EPDM	O-ring de adaptador/válvula y dos O-ring para el cuerpo
1-1/2"	12H-SKIT	acero, Al 303, Al 316, latón	nitrilo	O-ring de adaptador/válvula y dos O-ring para el cuerpo
	F-12H-SKIT	acero, Al 303, Al 316, latón	FKM	O-ring de adaptador/válvula y dos O-ring para el cuerpo
	P-12H-SKIT	acero, Al 303, Al 316, latón	EPDM	O-ring de adaptador/válvula y dos O-ring para el cuerpo

Medida	Serie-H ISO-B Repair Kits			
	Detalle			Repair Kit Contents (for one coupler or plug)
	# de Parte	Coupler Style	Seal Material	
1/4"	2H-RKIT	acero	nitrilo	Ensamble de válvula de acero y anillo de retención
	2H-BRKIT	latón	nitrilo	Ensamble de válvula de latón y anillo de retención
	2H-SRKIT	A.I. 303	nitrilo	Ensamble de válvula de AI 303 y anillo de retención
	2H-SSRKIT	A.I. 316	nitrilo	Ensamble de válvula de AI 316 y anillo de retención
3/8"	3H-RKIT	acero	nitrilo	Ensamble de válvula de acero y anillo de retención
	3H-BRKIT	latón	nitrilo	Ensamble de válvula de latón y anillo de retención
	3H-SRKIT	A.I. 303	nitrilo	Ensamble de válvula de AI 303 y anillo de retención
	3H-SSRKIT	A.I. 316	nitrilo	Ensamble de válvula de AI 316 y anillo de retención
1/2"	4H-RKIT	acero	nitrilo	Ensamble de válvula de acero y anillo de retención
	4H-BRKIT	latón	nitrilo	Ensamble de válvula de latón y anillo de retención
	4H-SRKIT	A.I. 303	nitrilo	Ensamble de válvula de AI 303 y anillo de retención
	4H-SSRKIT	A.I. 316	nitrilo	Ensamble de válvula de AI 316 y anillo de retención
3/4"	6H-RKIT	acero	nitrilo	Ensamble de válvula de acero y anillo de retención
	6H-BRKIT	latón	nitrilo	Ensamble de válvula de latón y anillo de retención
	6H-SRKIT	A.I. 303	nitrilo	Ensamble de válvula de AI 303 y anillo de retención
	6H-SSRKIT	A.I. 316	nitrilo	Ensamble de válvula de AI 316 y anillo de retención
1"	8H-RKIT	acero	nitrilo	Ensamble de válvula de acero y anillo de retención
	8H-BRKIT	latón	nitrilo	Ensamble de válvula de latón y anillo de retención
	8H-SRKIT	A.I. 303	nitrilo	Ensamble de válvula de AI 303 y anillo de retención
	8H-SSRKIT	A.I. 316	nitrilo	Ensamble de válvula de AI 316 y anillo de retención
1-1/4"	10H-RKIT	acero	nitrilo	Ensamble de válvula de acero y anillo de retención
	10H-BRKIT	latón	nitrilo	Ensamble de válvula de latón y adaptador O-ring
	10H-SRKIT	A.I. 303	nitrilo	Ensamble de Válvula AI 303 y adaptador O-ring
	10H-SSRKIT	A.I. 316	nitrilo	Ensamble de Válvula AI 316 y adaptador O-ring
1-1/2"	12H-RKIT	acero	nitrilo	Ensamble de válvula de acero y anillo de retención
	12H-BRKIT	latón	nitrilo	Ensamble de válvula de latón y adaptador O-ring
	12H-SRKIT	A.I. 303	nitrilo	Ensamble de Válvula AI 303 y adaptador O-ring
	12H-SSRKIT	A.I. 316	nitrilo	Ensamble de Válvula AI 316 y adaptador O-ring

Información de Intercambio

- Intercambiable con ISO7241 Serie B
- Eaton/Hansen Serie HKFR, DNP Serie HNV-BOP

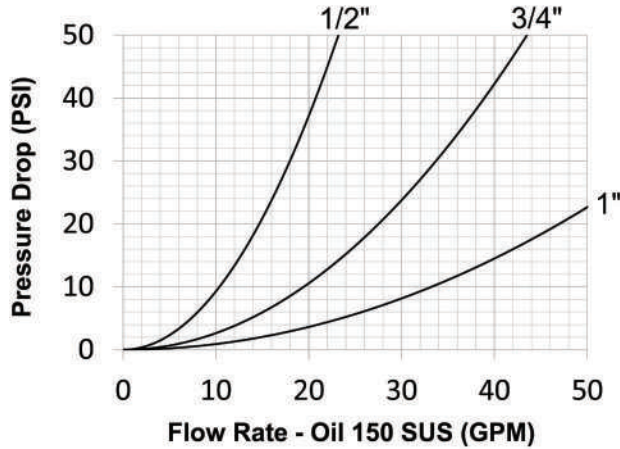

Componentes del Sello

- Acoples con Preventor de reventón (BOP) tienen sellos FKM para servicio severo.
- Los anillos PTFE anti-extrusión protegen el sello del cuerpo del acople de daños por impulso dinámico.
- El acople tiene un sistema de sellado O-ring
- Los sellos de las válvulas son crimpados en su lugar para mantener la integridad durante las condiciones de flujo excesivo y conexión presurizada.

Materiales

- Los componentes son maquinados con barras sólidas de acero o acero inoxidable 316.
- Balines, anillos de retención, y resortes de acero inoxidable que extienden la vida del servicio
- Los componentes de acero son platinados con zinc niquelado que cumple con la norma ROHS
- Las mangas de acople son endurecidas para resistir la deformación y maximizar la vida del servicio.
- Los nipples de acero son endurecidos para brindar un desempeño de trabajo pesado y resistencia
- Cubierta de pintura de polvo roja en manga y nipple para fácil identificación del servicio BOP
- La manga de seguridad es estándar

- Los acoples BOP han sido probados con fuego y certificados por Lloyd a 1300°F (700°C) de acuerdo con API 16D. Certificado disponible bajo pedido.
- Utiliza tapas y tapones Serie-H de la página 77

Tabla de Presión Nominal

Medida	Serie-H-BOP de Seguridad Preventor de Reventón									
	Cople/Niple Acero				Cople/Niple Al 316				Presión Prueba Lloyd's	Flujo $\Delta P = 22$ PSI
	Trabajo Máximo		Reventón		Trabajo Máximo		Reventón			
	PSI	Bar	PSI	Bar	PSI	Bar	PSI	Bar		
3/8"	5,000	345	16,500	1,150	5,000	345	21,500	1,450	5,000	12 GPM
1/2"	5,000	345	16,000	1,100	5,000	345	22,000	1,500	5,000	15 GPM
3/4"	5,000	345	16,500	1,150	5,000	345	21,500	1,450	5,000	29 GPM
1"	5,000	345	16,000	1,100	5,000	345	15,000	1,000	5,000	50 GPM

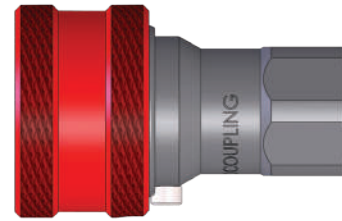
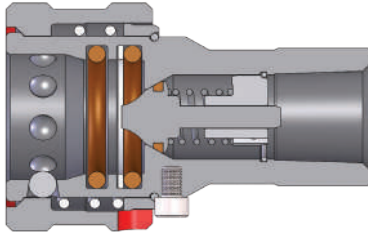

Medida	Serie-H-BOP Cople Seguridad Prevención de Reventón (Roscas Hembra)							
	Detalle			Medida		DE Máximo		Hex mm
	# de Parte	Roscas	Material	Pulg	mm	Pulg	mm	
3/8"	3HF3-BOP	3/8" - 18 NPTF	acero	2.50	63.5	1.41	35.8	7/8"
	3HF3-SS-BOP	3/8" - 18 NPTF	A.I. 316	2.50	63.5	1.41	35.8	7/8"
1/2"	4HF4-BOP	1/2" - 14 NPTF	acero	2.86	72.6	1.86	47.2	1-5/16"
	4HF4-SS-BOP	1/2" - 14 NPTF	A.I. 316	2.86	72.6	1.86	47.2	1-5/16"
3/4"	6HF6-BOP	3/4" - 14 NPTF	acero	3.55	90.2	2.22	56.4	1-5/16"
	6HF6-SS-BOP	3/4" - 14 NPTF	A.I. 316	3.55	90.2	2.22	56.4	1-5/16"
1"	8HF8-BOP	1" - 11-1/2 NPTF	acero	4.13	104.9	2.49	63.2	1-5/8"
	8HF8-SS-BOP	1" - 11-1/2 NPTF	A.I. 316	4.13	104.9	2.49	63.2	1-5/8"

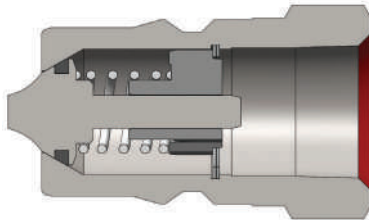

Medida	Serie-H-BOP Niple Seguridad Prevención de Reventón (Roscas Hembra)							
	Detalle			Medida		DE Máximo		Hex mm
	# de Parte	Roscas	Material	Pulg	mm	Pulg	mm	
3/8"	H3F3-BOP	3/8" - 18 NPTF	acero	1.53	38.9	0.96	24.4	7/8"
	H3F3-SS-BOP	3/8" - 18 NPTF	A.I. 316	1.53	38.9	0.96	24.4	7/8"
1/2"	H4F4-BOP	1/2" - 14 NPTF	acero	1.94	49.3	1.17	29.7	1-1/16"
	H4F4-SS-BOP	1/2" - 14 NPTF	A.I. 316	1.94	49.3	1.17	29.7	1-1/16"
3/4"	H6F6-BOP	3/4" - 14 NPTF	acero	2.41	61.2	1.44	36.6	1-5/16"
	H6F6-SS-BOP	3/4" - 14 NPTF	A.I. 316	2.41	61.2	1.44	36.6	1-5/16"
1"	H8F8-BOP	1" - 11-1/2 NPTF	acero	2.87	72.9	1.79	45.5	1-5/8"
	H8F8-SS-BOP	1" - 11-1/2 NPTF	A.I. 316	2.87	72.9	1.79	45.5	1-5/8"

Información de Intercambio

- Interchangeable to ISO7241 Series B
- Parker 60-Series steam couplings

Materiales

- Los componentes son maquinados con barras sólidas de acero, latón o acero inoxidable 303.
- Balines, anillos de retención, y resortes de acero inoxidable que extienden la vida del servicio
- Los componentes de acero son platinados con cromo trivalente y cumplen con la norma ROHS
- Los nipples de acero son endurecidos para brindar un desempeño de trabajo pesado y resistencia
- Todos los coples tienen manga de acero como estándar

Componentes del Sello

- Sellos de EPDM para vapor son estándar, brindando un rango de temperatura de **.70°F a 400°F (-57°C a 204°C)**
- Los coples tienen un sistema de sellado O-ring (O-ring dobles con PTFE)
- Los sellos de las válvulas están crimpados en su lugar para mantener la integridad durante el flujo excesivo



Tabla de Presión Nominal

Medida	Serie-HS Intercambio ISO-B Vapor (Conectado)															
	Cople/Niple Latón				Cople Latón/Niple Acero				Cople Latón/Niple AI 303				Cople/Niple AI 303			
	Max. Trabajo		Reventón		Max. Trabajo		Reventón		Max. Trabajo		Reventón		Max. Trabajo		Reventón	
	PSI	Bar	PSI	Bar	PSI	Bar	PSI	Bar	PSI	Bar	PSI	Bar	PSI	Bar	PSI	Bar
1/4"	200	14	14,500	1,000	200	14	14,500	1,000	200	14	14,500	1,000	200	14	31,500	2,150
3/8"	200	14	12,000	800	200	14	14,500	1,000	200	14	14,500	1,000	200	14	26,500	1,800
1/2"	200	14	11,500	750	200	14	14,500	1,000	200	14	14,500	1,000	200	14	27,500	1,900
3/4"	200	14	9,280	640	200	14	9,280	640	200	14	9,280	640	200	14	16,000	1,100
1"	200	14	5,800	400	200	14	5,800	400	200	14	5,800	400	200	14	15,000	1,000

Especificaciones Técnicas

Medida	Estándar Intercambiable				Parámetros Funcionales				
	Ejército USA	Gobierno USA	Estándar Internacional	Estándares ANSI/NFPA	Cantidad Balines	Inclusión de Aire	Pérdida de Flujo	Vacío Pulg HG	Flujo ΔP = 10 PSI
1/4"	-	-	ISO7241 B	B93.113M-B	8	1.1cc	0.9cc	27.4	88Lbs/Hr
3/8"	-	-	ISO7241 B	B93.113M-B	9	2.6cc	1.8cc	27.4	206Lbs/Hr
1/2"	-	-	ISO7241 B	B93.113M-B	9	3.8cc	2.9cc	27.4	302Lbs/Hr
3/4"	-	-	ISO7241 B	B93.113M-B	12	10.8cc	9.7cc	27.4	567Lbs/Hr
1"	-	-	ISO7241 B	B93.113M-B	12	15.9cc	15.3cc	27.4	968Lbs/Hr

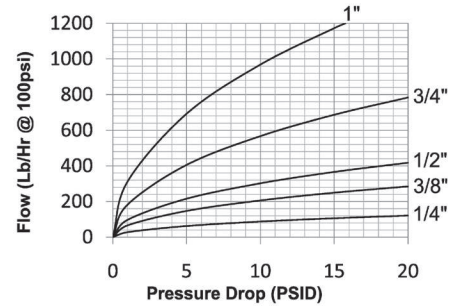

NOTA: La presión de trabajo máxima debe calcularse utilizando vapor saturado a **382°F (194°C)** para propósitos generales de servicio de vapor continuo. Para presiones de operación más avanzadas o aplicaciones de vapor supercaliente, contacte a Dixon para más información.

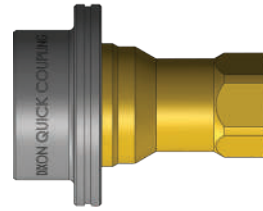
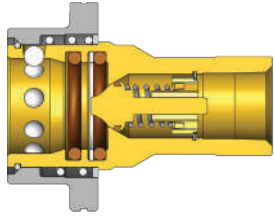

Medida	Serie-H Cople Intercambio ISO-B Vapor (Roscas Hembra)							
	Detalle			Medida		DE Máximo		Hex Pulg
	# de Parte	Roscas	Material	Pulg	mm	Pulg	mm	
1/4"	2HSF2-B	1/4" - 18 NPTF	latón	2.26	57.4	1.42	36.1	3/4"
	2HSF2-S	1/4" - 18 NPTF	A.I. 303	2.26	57.4	1.42	36.1	3/4"
	2HSBF2-B	1/4" - 19 BSPP	latón	2.26	57.4	1.42	36.1	3/4"
	2HSBF2-S	1/4" - 19 BSPP	A.I. 303	2.26	57.4	1.42	36.1	3/4"
3/8"	3HSF3-B	3/8" - 18 NPTF	latón	2.51	63.8	1.73	43.9	7/8"
	3HSF3-S	3/8" - 18 NPTF	A.I. 303	2.51	63.8	1.73	43.9	7/8"
	3HSBF3-B	3/8" - 19 BSPP	latón	2.51	63.8	1.73	43.9	7/8"
	3HSBF3-S	3/8" - 19 BSPP	A.I. 303	2.51	63.8	1.73	43.9	7/8"
1/2"	4HSF4-B	1/2" - 14 NPTF	latón	2.86	72.6	2.29	58.2	1-1/16"
	4HSF4-S	1/2" - 14 NPTF	A.I. 303	2.86	72.6	2.29	58.2	1-1/16"
	4HSBF4-B	1/2" - 14 BSPP	latón	2.86	72.6	2.29	58.2	1-1/16"
	4HSBF4-S	1/2" - 14 BSPP	A.I. 303	2.86	72.6	2.29	58.2	1-1/16"
3/4"	6HSF6-B	3/4" - 14 NPTF	latón	3.55	90.2	2.61	66.3	1-5/16"
	6HSF6-S	3/4" - 14 NPTF	A.I. 303	3.55	90.2	2.61	66.3	1-5/16"
	6HSBF6-B	3/4" - 14 BSPP	latón	3.55	90.2	2.61	66.3	1-5/16"
	6HSBF6-S	3/4" - 14 BSPP	A.I. 303	3.55	90.2	2.61	66.3	1-5/16"
1"	8HSF8-B	1" - 11-1/2 NPTF	latón	4.13	104.9	2.98	75.7	1-5/8"
	8HSF8-S	1" - 11-1/2 NPTF	A.I. 303	4.13	104.9	2.98	75.7	1-5/8"
	8HSBF8-B	1" - 11 BSPP	latón	4.13	104.9	2.98	75.7	1-5/8"
	8HSBF8-S	1" - 11 BSPP	A.I. 303	4.13	104.9	2.98	75.7	1-5/8"

! No desconecte los acoples de vapor bajo presión. La temperatura máxima de operación para el servicio de vapor es de **382°F (194°C)** con un máximo intermitente de temperatura de **-400°F (204°C)**. Asegurate de utilizar cadenas de seguridad o dispositivos equivalentes para prevenir que la línea se estropee por causa de un acople desconectado.

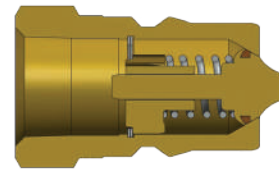

Medida	Serie-H Niple Intercambio ISO-B Vapor (Roscas Hembra)							
	Detalle			Medida		DE Máximo		Hex Pulg
	# de Parte	Roscas	Material	Pulg	mm	Pulg	mm	
1/4"	HS2F2	1/4" - 18 NPTF	acero	1.55	39.4	0.83	21.1	3/4"
	HS2F2-B	1/4" - 18 NPTF	latón	1.55	39.4	0.83	21.1	3/4"
	HS2F2-S	1/4" - 18 NPTF	A.I. 303	1.55	39.4	0.83	21.1	3/4"
	HS2BF2	1/4" - 19 BSPP	acero	1.55	39.4	0.83	21.1	3/4"
	HS2BF2-B	1/4" - 19 BSPP	latón	1.55	39.4	0.83	21.1	3/4"
	HS2BF2-S	1/4" - 19 BSPP	A.I. 303	1.55	39.4	0.83	21.1	3/4"
3/8"	HS3F3	3/8" - 18 NPTF	acero	1.70	43.2	0.97	24.6	7/8"
	HS3F3-B	3/8" - 18 NPTF	latón	1.70	43.2	0.97	24.6	7/8"
	HS3F3-S	3/8" - 18 NPTF	A.I. 303	1.70	43.2	0.97	24.6	7/8"
	HS3BF3	3/8" - 19 BSPP	acero	1.70	43.2	0.97	24.6	7/8"
	HS3BF3-B	3/8" - 19 BSPP	latón	1.70	43.2	0.97	24.6	7/8"
	HS3BF3-S	3/8" - 19 BSPP	A.I. 303	1.70	43.2	0.97	24.6	7/8"
1/2"	HS4F4	1/2" - 14 NPTF	acero	1.94	49.3	1.17	29.7	1-1/16"
	HS4F4-B	1/2" - 14 NPTF	latón	1.94	49.3	1.17	29.7	1-1/16"
	HS4F4-S	1/2" - 14 NPTF	A.I. 303	1.94	49.3	1.17	29.7	1-1/16"
	HS4BF4	1/2" - 14 BSPP	acero	1.94	49.3	1.17	29.7	1-1/16"
	HS4BF4-B	1/2" - 14 BSPP	latón	1.94	49.3	1.17	29.7	1-1/16"
	HS4BF4-S	1/2" - 14 BSPP	A.I. 303	1.94	49.3	1.17	29.7	1-1/16"
3/4"	HS6F6	3/4" - 14 NPTF	acero	2.41	61.2	1.44	36.6	1-5/16"
	HS6F6-B	3/4" - 14 NPTF	latón	2.41	61.2	1.44	36.6	1-5/16"
	HS6F6-S	3/4" - 14 NPTF	A.I. 303	2.41	61.2	1.44	36.6	1-5/16"
	HS6BF6	3/4" - 14 BSPP	acero	2.41	61.2	1.44	36.6	1-5/16"
	HS6BF6-B	3/4" - 14 BSPP	latón	2.41	61.2	1.44	36.6	1-5/16"
	HS6BF6-S	3/4" - 14 BSPP	A.I. 303	2.41	61.2	1.44	36.6	1-5/16"
1"	HS8F8	1" - 11-1/2 NPTF	acero	2.87	72.9	1.79	45.5	1-5/8"
	HS8F8-B	1" - 11-1/2 NPTF	latón	2.87	72.9	1.79	45.5	1-5/8"
	HS8F8-S	1" - 11-1/2 NPTF	A.I. 303	2.87	72.9	1.79	45.5	1-5/8"
	HS8BF8	1" - 11 BSPP	acero	2.87	72.9	1.79	45.5	1-5/8"
	HS8BF8-B	1" - 11 BSPP	latón	2.87	72.9	1.79	45.5	1-5/8"
	HS8BF8-S	1" - 11 BSPP	A.I. 303	2.87	72.9	1.79	45.5	1-5/8"

Información de Intercambio

- Intercambiable con ISO7241 Serie A
- Parker Serie 6600, Eaton/Aeroquip FD56 (5600)
- Faster ANV, Hansen HA15000, Safeway Serie S56

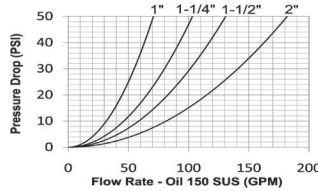
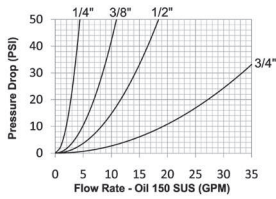

Materiales

- Los componentes son maquinados con barras sólidas de acero o acero inoxidable 316.
- Balines, anillos de retención, y resortes de acero inoxidable que extienden la vida del servicio.
- Los componentes de acero son platinados con cromo trivalente y cumplen con la norma ROHS
- Las mangas de acople son endurecidas para resistir la deformación y maximizar la vida del servicio.
- Los nipples de acero son endurecidos para brindar un desempeño de trabajo pesado y resistencia

Componentes del Sello

- Sellos de Nitrilo (Buna-N) estándar brindan un rango de temperatura de **-40°F a 250°F (-40°C a 121°C)**
- Los acoples tienen un anillo PTFE anti-extrusión
- Los sellos de las válvulas se crimpan para mantener la integridad durante condiciones de flujo excesivo y conexión presurizada

Tabla de Presión Nominal

Medida	Serie-K Intercambio ISO-A (Conectado)							
	Cople/Niple Acero							
	Trabajo Máximo				Reventón			
	Acero PSI	Acero Bar	A.I. 316 Acero PSI	A.I. 316 Acero Bar	Acero PSI	Acero Bar	A.I. 316 Acero PSI	A.I. 316 Acero Bar
1/4"	5,000	345	4,500	300	18,270	1,200	30,500	2,100
3/8"	4,000	275	3,750	250	16,000	1,100	16,000	1,100
1/2"	4,000	275	3,750	250	16,500	1,100	18,000	1,200
3/4"	4,000	275	3,000	200	14,800	1,000	12,000	800
1"	4,000	275	3,000	200	12,400	850	12,000	800
1-1/4"	3,000	200	-	-	12,600	850	-	-
1-1/2"	3,000	200	-	-	12,600	850	-	-
2"	1,450	100	-	-	5,800	400	-	-

Especificaciones Técnicas

Medida	Estándar Intercambiable				Parámetros Funcionales				
	Ejército USA	Gobierno USA	Estándar Internacional	Estándares ANSI/NFPA	Cantidad Balines	Inclusión de Aire	Pérdida de Flujo	Vacío Pulg HG	Vacío ΔP = 22 PSI
1/4"	-	-	ISO7241 A	-	6	0.6cc	0.3cc	26.5	2.9 GPM
3/8"	-	-	ISO7241 A	-	9	2.6cc	1.8cc	26.5	7 GPM
1/2"	-	-	ISO7241 A	-	9	3.8cc	2.9cc	26.5	12 GPM
3/4"	-	-	ISO7241 A	-	12	10.8cc	9.7cc	26.5	28 GPM
1"	-	-	ISO7241 A	-	15	15.9cc	15.3cc	26.5	50 GPM
1-1/4"	-	-	ISO7241 A	-	16	31.7cc	29.1cc	26.5	70 GPM
1-1/2"	-	-	ISO7241 A	-	16	56.4cc	52.2cc	26.5	90 GPM
2"	-	-	ISO7241 A	-	15	N/A	N/A	26.5	120 GPM

Opciones Disponibles

Medida	Opciones de Sello Estándar						Opciones de Sello Kalrez®		
	FKM	EPDM	FDA FKM	Mil-Nitrilo	Fuel Nitrilo	Silicone	4079	6375	7075
1/4"	F-	P-	D-	M-	JF-	S-	K4-	K6-	K7-
3/8"	F-	P-	D-	M-	JF-	S-	K4-	K6-	K7-
1/2"	F-	P-	D-	M-	JF-	S-	K4-	K6-	K7-
3/4"	F-	P-	D-	M-	JF-	S-	K4-	K6-	K7-
1"	F-	P-	D-	M-	JF-	S-	K4-	K6-	K7-
1-1/4"	N/A	N/A	N/A	N/A	N/A	N/A	N/A	N/A	N/A
1-1/2"	N/A	N/A	N/A	N/A	N/A	N/A	N/A	N/A	N/A
2"	N/A	N/A	N/A	N/A	N/A	N/A	N/A	N/A	N/A

Medida	Opciones de Válvula						Manga	Tratamiento
	Sin Válvula	Actuador ¹	Acero	Latón	Al 303	Al 316	Seguridad	Oxy-Clean
1/4"	-E	N/A	-ZV	-BV	N/A	N/A	-LS	-C1
3/8"	-E	-VA	-ZV	-BV	-SV	SSV	-LS	-C1
1/2"	-E	-VA	-ZV	-BV	-SV	SSV	-LS	-C1
3/4"	-E	-VA	-ZV	-BV	-SV	SSV	-LS	-C1
1"	-E	-VA	-ZV	-BV	-SV	SSV	-LS	-C1
1-1/4"	N/A	N/A	-ZV	N/A	N/A	N/A	N/A	N/A
1-1/2"	N/A	N/A	-ZV	N/A	N/A	N/A	N/A	N/A
2"	N/A	N/A	-ZV	N/A	N/A	N/A	N/A	N/A

¹Actuador de Válvula de Latón

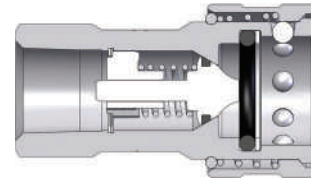
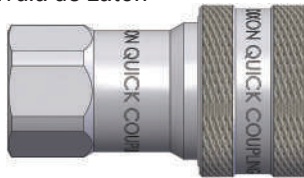

Medida	Serie-K Cople Intercambio ISO-A (Roscas Hembra)							
	Detalle			Medida		DE Máximo		Hex Pulg
	# de Parte	Roscas	Material	Pulg	mm	Pulg	mm	
1/4"	2KF1	1/8" - 27 NPTF	acero	1.89	47.9	1.00	25.4	3/4"
	2KF2	1/4" - 18 NPTF	acero	1.89	47.9	1.00	25.4	3/4"
	2KF2-SS	1/4" - 18 NPTF	A.I. 316	1.89	47.9	1.00	25.4	3/4"
	2KBF2	1/4" - 19 BSPP	acero	1.89	47.9	1.00	25.4	3/4"
	2KBF2-SS	1/4" - 19 BSPP	A.I. 316	1.89	47.9	1.00	25.4	3/4"
	2KOF2	7/16" - 20 ORB	acero	1.89	47.9	1.00	25.4	3/4"
3/8"	3KF3	3/8" - 18 NPTF	acero	2.23	56.5	1.19	30.2	7/8"
	3KF3-SS	3/8" - 18 NPTF	A.I. 316	2.23	56.5	1.19	30.2	7/8"
	3KBF3	3/8" - 19 BSPP	acero	2.23	56.6	1.19	30.2	7/8"
	3KBF3-SS	3/8" - 19 BSPP	A.I. 316	2.23	56.6	1.19	30.2	7/8"
	3KOF3	9/16" - 18 ORB	acero	2.23	56.6	1.19	30.2	7/8"
1/2"	4KF4	1/2" - 14 NPTF	acero	2.62	66.5	1.49	37.8	1-1/16"
	4KF4-SS	1/2" - 14 NPTF	A.I. 316	2.62	66.5	1.49	37.8	1-1/16"
	4KBF4	1/2" - 14 BSPP	acero	2.62	66.5	1.49	37.8	1-1/16"
	4KBF4-SS	1/2" - 14 BSPP	A.I. 316	2.62	66.5	1.49	37.8	1-1/16"
	4KOF4	3/4" - 16 ORB	acero	2.62	66.5	1.49	37.8	1-1/16"
	4KOF5	7/8" - 14 ORB	acero	2.66	67.6	1.49	37.8	1-3/32"
	4KF6	3/4" - 14 NPTF	acero	2.64	66.9	1.49	37.8	1-5/16"

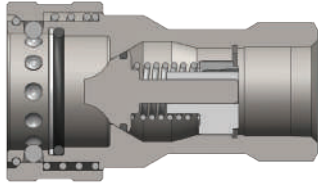

Medida	Serie-K Cople Intercambio ISO-A (Roscas Hembra)							
	Detalle			Medida		DE Máximo		Hex Pulg
	# de Parte	Roscas	Material	Pulg	mm	Pulg	mm	
3/4"	6KF6	3/4" - 14 NPTF	acero	3.23	82.0	1.86	47.2	1-5/16"
	6KF6-SS	3/4" - 14 NPTF	A.I. 316	3.23	82.0	1.86	47.2	1-5/16"
	6KBF6	3/4" - 14 BSPP	acero	3.23	82.0	1.86	47.2	1-5/16"
	6KBF6-SS	3/4" - 14 BSPP	A.I. 316	3.23	82.0	1.86	47.2	1-5/16"
	6KOF6	1-1/16" - 12 ORB	acero	3.23	82.0	1.86	47.2	1-5/16"
1"	8KF8	1" - 11-1/2 NPTF	acero	3.88	98.6	2.10	53.3	1-5/8"
	8KF8-SS	1" - 11-1/2 NPTF	A.I. 316	3.88	98.6	2.10	53.3	1-5/8"
	8KBF8	1" - 11 BSPP	acero	3.88	98.6	2.10	53.3	1-5/8"
	8KBF8-SS	1" - 11 BSPP	A.I. 316	3.88	98.6	2.10	53.3	1-5/8"
	8KOF8	1-5/16" - 12 ORB	acero	3.88	98.6	2.10	53.3	1-5/8"

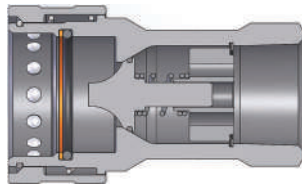

Medida	Serie-K Cople Intercambio ISO-A (Roscas Hembra)							
	Detalle			Medida		DE Máximo		Hex Pulg
	# de Parte	Roscas	Material	Pulg	mm	Pulg	mm	
1-1/4"	10KF10	1-1/4" - 11-1/2 NPT	acero	4.61	117.0	2.76	70.0	2"
	10KBF10	1-1/4" - 11 BSPP	acero	4.61	117.0	2.76	70.0	2"
1-1/2"	12KF12	1-1/2" - 11-1/2 NPT	acero	5.24	133.0	3.33	84.5	2-3/8"
	12KBF12	1-1/2" - 11 BSPP	acero	5.24	133.0	3.33	84.5	2-3/8"
2"	16KF16	2" - 11-1/2 NPT	acero	6.50	165.0	3.94	100.0	3"
	16KBF16	2" - 11 BSPP	acero	6.50	165.0	3.94	100.0	3"

Medida	A	B
1/4"	0.46	0.17
3/8"	0.68	0.29
1/2"	0.81	0.37
3/4"	1.14	0.55
1"	1.35	0.66
1-1/4"	1.77	0.98
1-1/2"	2.16	1.21
2"	2.56	1.38

Perfil Serie-K

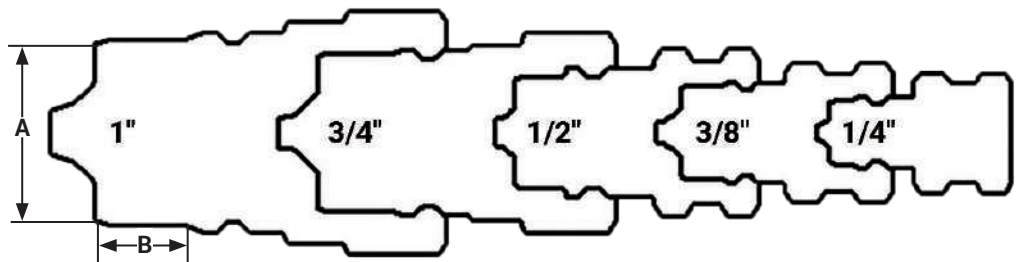

Coples Hidráulicos: Serie-K

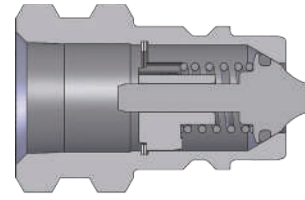
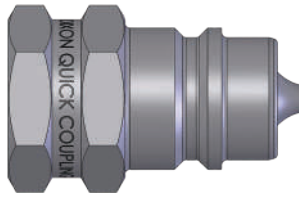

Medida	Serie-K Niple Intercambio ISO-A (Roscas Hembra)							
	Detalle			Medida		DE Máximo		Hex Pulg
	# de Parte	Roscas	Material	Pulg	mm	Pulg	mm	
1/4"	K2F1	1/8" - 27 NPTF	acero	1.22	31.0	0.87	22.1	3/4"
	K2F2	1/4" - 18 NPTF	acero	1.22	31.0	0.87	22.1	3/4"
	K2F2-SS	1/4" - 18 NPTF	A.I. 316	1.22	31.0	0.87	22.1	3/4"
	K2BF2	1/4" - 19 BSPP	acero	1.22	31.0	0.87	22.1	3/4"
	K2BF2-SS	1/4" - 19 BSPP	A.I. 316	1.22	31.0	0.87	22.1	3/4"
	K2OF2	7/16" - 20 ORB	acero	1.22	31.0	0.87	22.1	3/4"
3/8"	K3F3	3/8" - 18 NPTF	acero	1.70	43.2	0.97	24.6	7/8"
	K3F3-SS	3/8" - 18 NPTF	A.I. 316	1.70	43.2	0.97	24.6	7/8"
	K3BF3	3/8" - 19 BSPP	acero	1.70	43.2	0.97	24.6	7/8"
	K3BF3-SS	3/8" - 19 BSPP	A.I. 316	1.70	43.2	0.97	24.6	7/8"
	K3OF3	9/16" - 18 ORB	acero	1.70	43.2	0.97	24.6	7/8"
1/2"	K4F4	1/2" - 14 NPTF	acero	1.77	45.0	1.23	31.2	1-1/16"
	K4F4-SS	1/2" - 14 NPTF	A.I. 316	1.77	45.0	1.23	31.2	1-1/16"
	K4BF4	1/2" - 14 BSPP	acero	1.77	45.0	1.23	31.2	1-1/16"
	K4BF4-SS	1/2" - 14 BSPP	A.I. 316	1.77	45.0	1.23	31.2	1-1/16"
	K4OF4	3/4" - 16 ORB	acero	1.77	45.0	1.23	31.2	1-1/16"
	K4OF5	7/8" - 14 ORB	acero	1.77	45.0	1.23	31.2	1-1/16"
	K4F6	3/4" - 14 NPTF	acero	1.77	45.0	1.37	34.8	1-3/16"

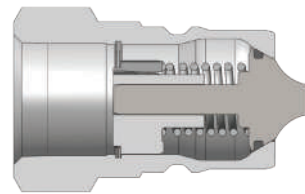

Medida	Serie-K Niple Intercambio ISO-A (Roscas Hembra)							
	Detalle			Medida		DE Máximo		Hex Pulg
	# de Parte	Roscas	Material	Pulg	mm	Pulg	mm	
3/4"	K6F6	3/4" - 14 NPTF	acero	2.43	61.7	1.44	36.6	1-5/16"
	K6F6-SS	3/4" - 14 NPTF	A.I. 316	2.43	61.7	1.44	36.6	1-5/16"
	K6BF6	3/4" - 14 BSPP	acero	2.43	61.7	1.44	36.6	1-5/16"
	K6BF6-SS	3/4" - 14 BSPP	A.I. 316	2.43	61.7	1.44	36.6	1-5/16"
	K6OF6	1-1/16" - 12 ORB	acero	2.43	61.7	1.44	36.6	1-5/16"
1"	K8F8	1" - 11-1/2 NPTF	acero	2.87	72.9	1.79	45.5	1-5/8"
	K8F8-SS	1" - 11-1/2 NPTF	A.I. 316	2.87	72.9	1.79	45.5	1-5/8"
	K8BF8	1" - 11 BSPP	acero	2.87	72.9	1.79	45.5	1-5/8"
	K8BF8-SS	1" - 11 BSPP	A.I. 316	2.87	72.9	1.79	45.5	1-5/8"
	K8OF8	1-5/16" - 12 ORB	acero	2.87	72.9	1.79	45.5	1-5/8"
1-1/4"	K10F10	1-1/4" - 11-1/2 NPT	acero	2.95	75.0	2.31	58.7	2"
	K10BF10	1-1/4" - 11 BSPP	acero	2.95	75.0	2.31	58.7	2"
1-1/2"	K12F12	1-1/2" - 11-1/2 NPT	acero	3.29	83.5	2.74	69.6	2-3/8"
	K12BF12	1-1/2" - 11 BSPP	acero	3.29	83.5	2.74	69.6	2-3/8"
2"	K16F16	2" - 11-1/2 NPT	acero	4.13	105.0	3.46	87.9	3"
	K16BF16	2" - 11 BSPP	acero	4.13	105.0	3.46	87.9	3"



Medida	Serie-K Tapas y Tapones Intercambio ISO-A		
	Detalle		
	Combinación de Tapa o Tapón		Material
1/4"	2KDP-K2DC		nitrilo
3/8"	3KDP-K3DC		nitrilo
1/2"		ver debajo	
3/4"	6KDP-K6DC		nitrilo
1"	8KDP-K8DC		nitrilo



Medida	Serie-K Tapas y Tapones de Colores Intercambio ISO-A		
	Detalle		
	# de Parte	Color	Material
1/2"	4KDP	negro	nitrilo
	4K-R-DP	rojo	nitrilo
	4K-O-DP	naranja	nitrilo
	4K-Y-DP	amarillo	nitrilo
	4K-G-DP	verde	nitrilo
	4K-B-DP	azúl	nitrilo



Medida	Serie-K Tapas y Tapones de Colores Intercambio ISO-A		
	Detalle		
	# de Parte	Color	Material
1/2"	K4DC	negro	nitrilo
	K4-R-DC	rojo	nitrilo
	K4-O-DC	naranja	nitrilo
	K4-Y-DC	amarillo	nitrilo
	K4-G-DC	verde	nitrilo
	K4-B-DC	azúl	nitrilo

Coples Hidráulicos: Serie-K

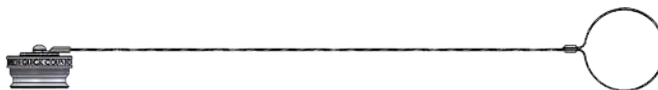

Medida	Serie-K Tapón ISO-A		
	Detalle		
	# de Parte	Lanyard	Body
1-1/4"	10KDP-A	cable de acero	aluminio
1-1/2"	12KDP-A	cable de acero	aluminio
2"	16KDP-A	cable de acero	aluminio



Medida	Serie-K Tapa ISO-A		
	Detalle		
	# de Parte	Lanyard	Body
1-1/4"	K10DC-A	cable de acero	aluminio
1-1/2"	K12DC-A	cable de acero	aluminio
2"	K16DC-A	cable de acero	aluminio

Medida	Serie-K Kit de Sellos para Acople ISO-A			
	Detalle			Contenido de Kit de Sellos
	# de Parte	Estilo de Cople	Material	
1/4"	2K-SKIT	Todos	Nitrilo	O-ring y anillo anti-extrusión PTFE
3/8"	3K-SKIT	Todos	Nitrilo	O-ring y anillo anti-extrusión PTFE
1/2"	4K-SKIT	Todos	Nitrilo	O-ring y anillo anti-extrusión PTFE
3/4"	6K-SKIT	Todos	Nitrilo	O-ring y anillo anti-extrusión PTFE
1"	8K-SKIT	Todos	Nitrilo	O-ring y anillo anti-extrusión PTFE
1-1/4"	10K-SKIT	Todos	Nitrilo	O-ring y anillo anti-extrusión PTFE
1-1/2"	12K-SKIT	Todos	Nitrilo	O-ring y anillo anti-extrusión PTFE
2"	16K-SKIT	Todos	Nitrilo	O-ring y anillo anti-extrusión PTFE

Información de Intercambio

- Intercambio Agrícola
- Parker/Pioneer Serie 4000, Faster Serie NS/NV
- Safeway Serie-S20, Stucchi IR-Serie, Snap-Tite Serie-60

Materiales

- Los componentes son maquinados con barras sólidas de acero o latón.
- Balines, anillos de retención, y resortes de acero inoxidable que extienden la vida del servicio
- Los componentes de acero son platinados con cromo trivalente y cumplen con la norma ROHS
- Las mangas de acople son endurecidas para resistir la deformación y maximizar la vida del servicio.
- Los nipples de acero son endurecidos para brindar un desempeño de trabajo pesado y resistencia

Componentes del Sello

- Sellos de Nitrilo (Buna-N) estándar brindan un rango de temperatura de **-40°F a 250°F (-40°C a 121°C)**
- Los acoples tienen un anillo PTFE anti-extrusión
- Los sellos de las válvulas poppet se crimpan para mantener la integridad durante condiciones de flujo excesivo y conexión presurizada



Tabla de Presión Nominal

Medida	Serie-AG Intercambio Agrícola (Conectado)							
	Cople Bola /Niple Acero				Cople Poppet/Niple Acero			
	Trabajo Máximo		Reventón		Trabajo Máximo		Reventón	
	PSI	Bar	PSI	Bar	PSI	Bar	PSI	Bar
1/4"	4,000	275	24,400	1,700	4,000	275	21,000	1,500
3/8"	4,000	275	25,000	1,700	4,000	275	16,100	1,100
1/2"	4,000	275	16,500	1,100	4,000	275	16,500	1,100
3/4"	3,000	200	15,800	1,050	3,000	200	10,300	700
1"	3,000	200	13,500	900	3,000	200	13,000	900

Especificaciones Técnicas

Medida	Estándar Intercambiable				Parámetros Funcionales				
	Ejército USA	Gobierno USA	Estándar Internacional	Estándares ANSI/NFPA	Cantidad Balines	Inclusión de Aire	Pérdida de Flujo	Vacío Pulg HG	Flujo ΔP = 22 PSI
1/4"	-	-	-	-	8	1.1cc	0.9cc	26.5	4 GPM
3/8"	-	-	-	-	9	2.6cc	1.8cc	26.5	6 GPM
1/2"	-	-	ISO7241 A	-	9	3.8cc	2.9cc	26.5	12 GPM
3/4"	-	-	ISO5675	-	12	10.8cc	9.7cc	26.5	28 GPM
1"	-	-	-	-	12	15.9cc	15.3cc	26.5	48 GPM

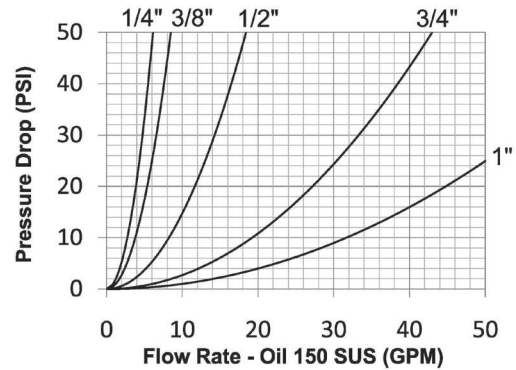
Perfil Serie-AG

Medida	A	B
1/4"	0.56	0.31
3/8"	0.74	0.35
1/2"	0.81	0.37
3/4"	1.06	0.50
1"	1.23	0.62

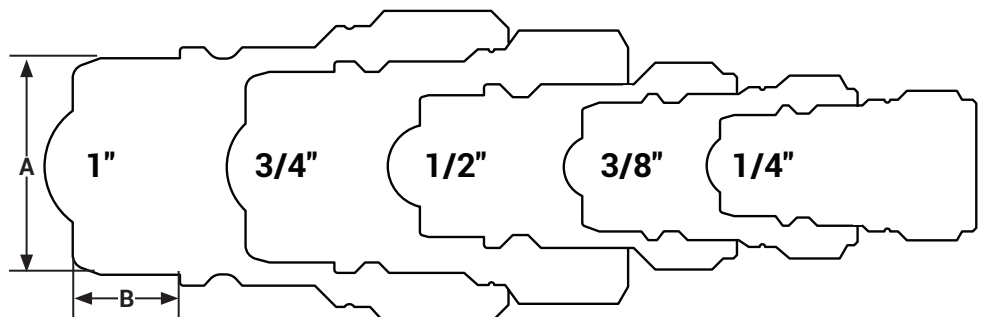

Coples Hidráulicos: Serie-AG

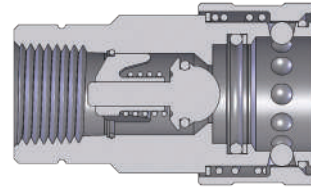
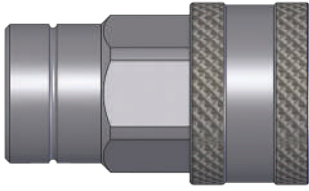

Medida	Serie-AG Cople Válvula de Bola Intercambio Agrícola (Roscas Hembra)							
	Detalle			Medida		DE Máximo		Hex Pulg
	# de Parte	Roscas	Material	Pulg	mm	Pulg	mm	
1/4"	2AGF2	1/4" - 18 NPTF	acero	2.06	52.3	1.12	28.4	7/8"
3/8"	3AGF3	3/8" - 18 NPTF	acero	2.31	58.6	1.42	36.0	7/8"
1/2"	4AGF4	1/2" - 14 NPTF	acero	2.62	66.5	1.50	38.1	1-1/16"
	4AGBF4	1/2" - 14 BSPP	acero	2.62	66.5	1.50	38.1	1-1/16"
	4AGOF4	3/4" - 16 ORB	acero	2.62	66.5	1.50	38.1	1-1/16"
	4AGOF5	7/8" - 14 ORB	acero	2.66	67.5	1.50	38.1	1-3/32"
	4AGF6	3/4" - 14 NPTF	acero	2.64	67.0	1.50	38.1	1-5/16"
3/4"	6AGF6	3/4" - 14 NPTF	acero	3.23	82.0	1.88	47.7	1-5/16"
1"	8AGF8	1" - 11-1/2 NPTF	acero	3.79	96.2	2.12	53.8	1-5/8"

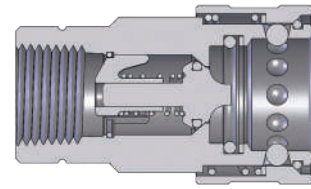
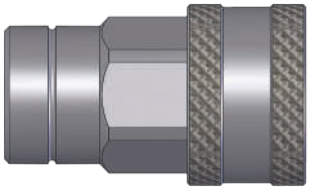

Medida	Serie-AG Cople Válvula Poppet Intercambio Agrícola (Roscas Hembra)							
	Detalle			Medida		DE Máximo		Hex Pulg
	# de Parte	Roscas	Material	Pulg	mm	Pulg	mm	
1/4"	2AGF2-PV	1/4" - 18 NPTF	acero	2.06	52.3	1.12	27.0	7/8"
3/8"	3AGF3-PV	3/8" - 18 NPTF	acero	2.31	58.6	1.42	34.0	7/8"
1/2"	4AGF4-PV	1/2" - 14 NPTF	acero	2.62	66.5	1.50	37.8	1-1/16"
	4AGBF4-PV	1/2" - 14 BSPP	acero	2.62	66.5	1.50	37.8	1-1/16"
	4AGOF4-PV	3/4" - 16 ORB	acero	2.62	66.5	1.50	37.8	1-1/16"
	4AGOF5-PV	7/8" - 14 ORB	acero	2.66	67.5	1.50	37.8	1-3/32"
	4AGF6-PV	3/4" - 14 NPTF	acero	2.64	67.0	1.50	37.8	1-5/16"
3/4"	6AGF6-PV	3/4" - 14 NPTF	acero	3.23	82.0	1.88	48.0	1-5/16"
1"	8AGF8-PV	1" - 11-1/2 NPTF	acero	3.79	96.2	2.12	55.0	1-5/8"

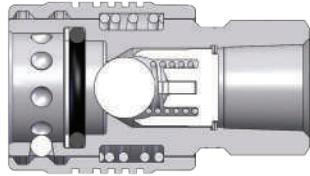

Serie-AG Cople Válvula de Bola Push-Pull Intercambio Agrícola (Roscas Hembra)

Medida	Detalle			Medida		DE Máximo		Hex Pulg
	# de Parte	Roscas	Material	Pulg	mm	Pulg	mm	
3/8"	3AGF3-PS	3/8" - 18 NPTF	acero	2.31	58.6	1.42	36.07	7/8"
1/2"	4AGF4-PS	1/2" - 14 NPTF	acero	2.62	66.5	1.49	37.8	1-1/16"
	4AGOF4-PS	3/4" - 16 ORB	acero	2.62	66.5	1.48	37.8	1-1/16"
	4AGOF5-PS	7/8" - 14 ORB	acero	2.66	67.5	1.48	37.8	1-1/16"
3/4"	4AGF6-PS	3/4" - 14 NPTF	acero	2.74	69.6	1.48	37.8	1-3/16"
	6AGF6-PS	3/4" - 14 NPTF	acero	3.23	82.0	1.86	47.2	1-3/16"

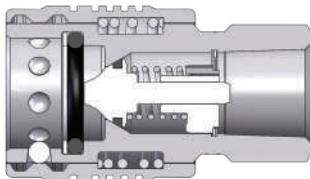

Serie-AG Cople Válvula Poppet Push-Pull Intercambio Agrícola (Roscas Hembra)

Medida	Detalle			Medida		DE Máximo		Hex Pulg
	# de Parte	Roscas	Material	Pulg	mm	Pulg	mm	
3/8"	3AGF3-PV-PS	3/8" - 18 NPTF	acero	2.31	58.6	1.42	36.0	7/8"
1/2"	4AGF4-PV-PS	1/2" - 14 NPTF	acero	2.62	66.5	1.49	37.8	1-1/16"
	4AGOF4-PV-PS	3/4" - 16 ORB	acero	2.62	66.5	1.49	37.8	1-1/16"
	4AGOF5-PV-PS	7/8" - 14 ORB	acero	2.66	66.5	1.49	37.8	1-1/16"
	4AGF6-PV-PS	3/4" - 14 NPTF	acero	2.74	69.6	1.49	37.8	1-3/16"
	6AGF6-PV-PS	3/4" - 14 NPTF	acero	3.23	82.0	1.86	47.2	1-3/16"

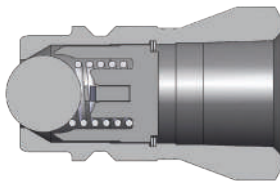

Serie-AG Niple Válvula de Bola Push-Pull Intercambio Agrícola (Roscas Hembra)

Medida	Detalle			Medida		DE Máximo		Hex Pulg
	# de Parte	Roscas	Material	Pulg	mm	Pulg	mm	
1/4"	AG2F2	1/4" - 18 NPTF	acero	1.42	36.0	0.84	21.3	3/4"
3/8"	AG3F3	3/8" - 18 NPTF	acero	1.61	40.8	1.05	26.6	15/16"
1/2"	AG4F4	1/2" - 14 NPTF	acero	1.95	49.5	1.21	30.7	1-1/16"
	AG4BF4	1/2" - 14 BSPP	acero	1.95	49.5	1.21	30.7	1-1/16"
	AG4OF4	3/4" - 16 ORB	acero	2.10	53.3	1.26	30.7	1-1/16"
	AG4OF5	7/8" - 14 ORB	acero	2.10	53.3	1.26	32.0	1-1/4"
	AG4F6	3/4" - 14 NPTF	acero	2.30	58.4	1.32	33.5	1-3/16"
3/4"	AG6F6	3/4" - 14 NPTF	acero	2.30	58.4	1.51	38.3	1-3/8"
1"	AG8F8	1" - 11-1/2 NPTF	acero	2.57	65.2	1.74	44.7	1-5/8"

Coples Hidráulicos: Serie-AG

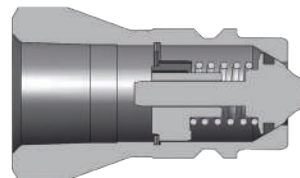

Medida	Serie-AG Niple Válvula Poppet Push-Pull Intercambio Agrícola (Roscas Hembra)							
	Detalle			Medida		DE Máximo		Hex Pulg
	# de Parte	Roscas	Material	Pulg	mm	Pulg	mm	
1/4"	AG2F2-PV	1/4" - 18 NPTF	acero	1.42	36.0	0.84	21.3	3/4"
3/8"	AG3F3-PV	3/8" - 18 NPTF	acero	1.61	40.8	1.05	26.6	15/16"
1/2"	AG4F4-PV	1/2" - 14 NPTF	acero	2.08	52.8	1.21	30.7	1-1/16"
	AG4BF4-PV	1/2" - 14 BSPP	acero	2.08	52.8	1.21	30.7	1-1/16"
	AG4OF4-PV	3/4" - 16 ORB	acero	2.08	52.8	1.21	30.7	1-1/16"
	AG4OF5-PV	7/8" - 14 ORB	acero	2.13	54.1	1.26	32.0	1-1/16"
3/4"	AG4F6-PV	3/4" - 14 NPTF	acero	2.30	58.4	1.32	33.5	1-3/16"
	AG6F6-PV	3/4" - 14 NPTF	acero	2.30	58.4	1.51	38.3	1-3/8"
1"	AG8F8-PV	1" - 11-1/2 NPTF	acero	2.71	68.8	1.76	44.7	1-5/8"



Medida	Serie-AG Tapón para Acople Intercambio Agrícola		
	Detalle		
	# de Parte	Cordón	Cuerpo
1/4"	2AGDP	elastómero	elastómero
3/8"	3AGDP	elastómero	elastómero
1/2"	Para medida 1/2" vea los códigos de color para las tapas Serie-K -en página 89		
3/4"	6AGDP	elastómero	elastómero
1"	8AGDP	elastómero	elastómero



Medida	Serie-AG Tapa para Acople Intercambio Agrícola		
	Detalle		
	# de Parte	Cordón	Cuerpo
1/4"	AG2DC	elastómero	elastómero
3/8"	AG3DC	elastómero	elastómero
1/2"	Para medida 1/2" vea los códigos de color para las tapas Serie-K -en página 89		
3/4"	AG6DC	elastómero	elastómero
1"	AG8DC	elastómero	elastómero

Información de Intercambio

- Intercambio con MIL-C-51234
- Snap-Tite H/IH y Faster TNV/TNL

Materiales

- Los componentes son maquinados con barras sólidas de acero, latón o acero inoxidable 316.
- Balines, anillos de retención, y resortes de acero inoxidable que extienden la vida del servicio
- Los componentes de acero son platinados con cromo trivalente y cumplen con la norma ROHS
- Las mangas de acople son endurecidas para resistir la deformación y maximizar la vida del servicio.
- Los nipples son maquinados de acero endurecido y endurecidos por inducción
- Válvulas TV tubulares construidas de barra de acero y diseñados para un desempeño óptimo en aplicaciones neumáticas

Componentes del Sello

- Sellos de Nitrilo (Buna-N) estándar brindan un rango de temperatura de **-40°F a 250°F (-40°C a 121°C)**
- Todos los acoples incorporan un anillo PTFE anti-extrusión para proteger los componentes del sello de daños por impulso dinámico.
- Sellos de válvula de 1/4" a 1" son crimpados para mantener la integridad durante condiciones de flujo excesivas o conexión presurizada
- O-rings de válvula de 1-1/4" a 2" están retenidos por una ranura de sello única y es reemplazable en campo.

NOTA: Datos de flujo de aire se presentan utilizando un cople con una válvula TV y niple sin válvula. Esta configuración brinda el desempeño óptimo para aplicaciones neumáticas.

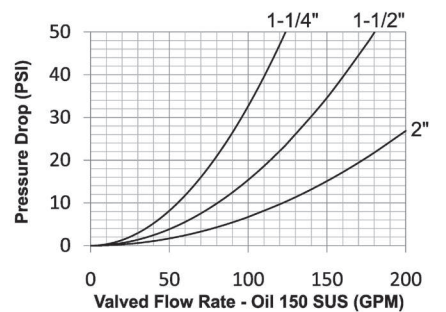
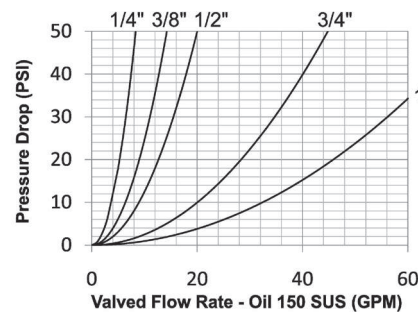
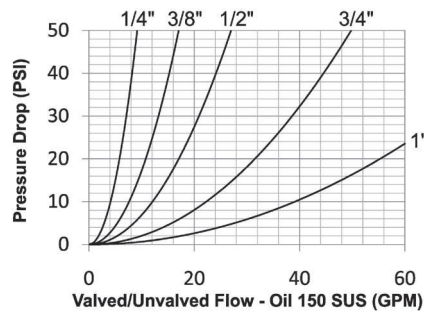
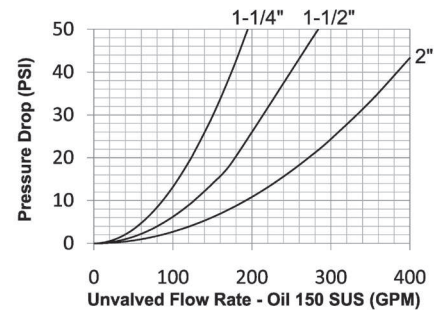
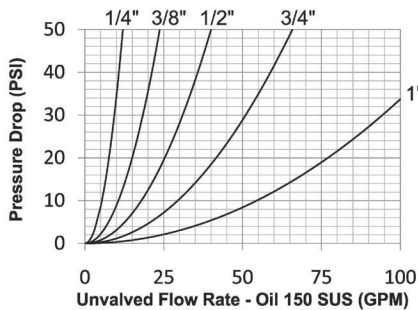
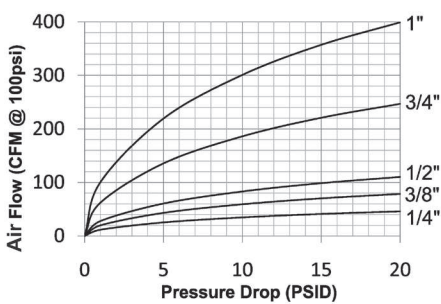

Perfil Serie-V

Medida	A	B
1/4"	0.43	0.23
3/8"	0.51	0.29
1/2"	0.63	0.29
3/4"	0.92	0.43
1"	1.17	0.41



Tabla de Valores de Presión

Medida	Serie-V MIL-C-51234 (Válvula Conectada)											
	Cople/Niple Acero				Cople/Niple Latón				Cople/Niple A.I. 316			
	Trabajo Máximo		Reventón		Trabajo Máximo		Reventón		Trabajo Máximo		Reventón	
	PSI	Bar	PSI	Bar	PSI	Bar	PSI	Bar	PSI	Bar	PSI	Bar
1/4"	6,500	450	12,700	876	2,250	150	5,000	345	5,000	345	10,000	700
3/8"	4,500	310	10,500	700	2,250	150	5,300	350	4,000	275	8,000	550
1/2"	4,000	275	9,600	650	2,000	130	5,700	390	3,750	260	7,500	500
3/4"	3,500	240	9,100	600	2,000	130	5,300	350	2,000	130	7,500	500
1"	2,000	130	9,500	650	1,750	120	5,000	345	2,000	130	5,000	345
1-1/4"	1,750	120	5,000	345	350	24	1,000	70	1,500	100	3,000	200
1-1/2"	1,500	100	5,000	345	350	24	1,200	80	1,500	100	3,000	200
2"	1,500	100	4,000	275	400	28	1,000	70	500	34	1,000	70

Medida	Serie-V MIL-C-51234 (Sin válvula Conectada)											
	Cople/Niple Acero				Cople/Niple Latón				Cople/Niple A.I. 316			
	Trabajo Máximo		Reventón		Trabajo Máximo		Reventón		Trabajo Máximo		Reventón	
	PSI	Bar	PSI	Bar	PSI	Bar	PSI	Bar	PSI	Bar	PSI	Bar
1/4"	11,000	760	29,500	2,000	4,000	275	14,200	980	10,000	670	29,200	2,000
3/8"	11,000	760	29,900	2,000	4,000	275	14,500	1,000	8,000	550	27,900	1,900
1/2"	11,000	760	29,300	2,000	4,000	275	14,500	1,000	8,000	550	24,600	1,700
3/4"	9,000	620	19,300	1,300	3,500	250	11,100	750	7,000	480	22,600	1,500
1"	6,000	400	15,900	1,100	3,000	200	8,200	560	4,000	275	15,500	1,000
1-1/4"	5,000	345	10,000	700	1,000	70	4,000	275	3,000	200	10,000	700
1-1/2"	5,000	345	10,000	700	1,000	70	4,000	275	3,000	200	10,000	700
2"	4,000	275	8,000	550	750	50	2,800	190	1,000	70	6,000	400

Especificaciones Técnicas

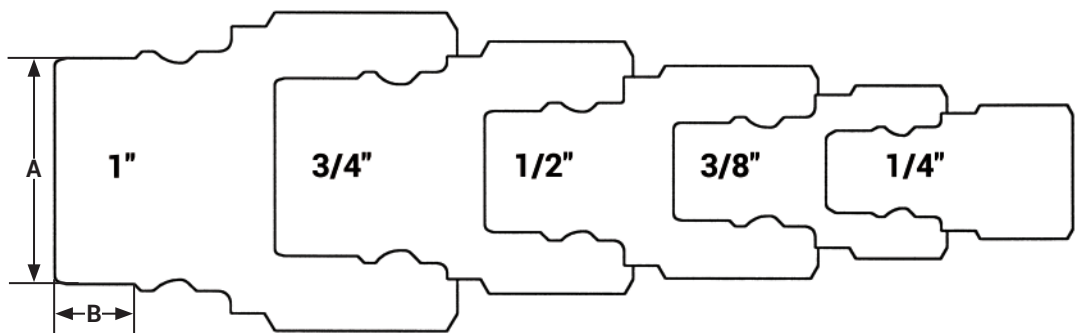
Medida	Estándar Intercambio			Parámetros Funcionales				
	Ejército USA	Estántar Int	Estándar ANSI/NFPA	Cant Balines	Inclusión Aire	Pérdida Fluido	Vacío pulg HG	Flujo ΔP = 22 PSI
1/4"	MIL-C-51234	-	-	6	2.0cc	0.2cc	26.7	5.5 GPM
3/8"	MIL-C-51234	-	-	6	3.5cc	3.2cc	26.7	9.5 GPM
1/2"	MIL-C-51234	-	-	9	4.0cc	4.0cc	26.7	13.0 GPM
3/4"	MIL-C-51234	-	-	9	14.0cc	14.0cc	26.7	30.0 GPM
1"	MIL-C-51234	-	-	12	21.0cc	20.0cc	26.7	48.0 GPM
1-1/4"	MIL-C-51234	-	-	12	45.0cc	45.0cc	N/R	82.0 GPM
1-1/2"	MIL-C-51234	-	-	12	80.0cc	80.0cc	N/R	120.0 GPM
2"	MIL-C-51234	-	-	12	150.0cc	150.0cc	N/R	185.0 GPM

Opciones Disponibles

Medida	Opciones de Sellado Estándar							Opciones de Sello Kalrez®		
	FKM	EPDM	Vapor-EP	FDA FKM	Mil-Nitrilo	Nitrilo Combustible	Silicón	4079	6375	7075
1/4"	F-	P-	PS-	D-	M-	JF-	S-	K4-	K6-	K7-
3/8"	F-	P-	PS-	D-	M-	JF-	S-	K4-	K6-	K7-
1/2"	F-	P-	PS-	D-	M-	JF-	S-	K4-	K6-	K7-
3/4"	F-	P-	PS-	D-	M-	JF-	S-	K4-	K6-	K7-
1"	F-	P-	PS-	D-	M-	JF-	S-	K4-	K6-	K7-
1-1/4"	F-	P-	PS-	D-	M-	JF-	S-	K4-	K6-	K7-
1-1/2"	F-	P-	PS-	D-	M-	JF-	S-	K4-	K6-	K7-
2"	F-	P-	PS-	D-	M-	JF-	S-	K4-	K6-	K7-

Medida	Opciones de Válvula					Opciones de Manga			Tratamiento
	Sin válvula	Tubular	Acero	Latón	Al 316	Sleeve-Lock	Bridado	Sil-Flange	Oxy-Clean
1/4"	-E	-TV	-ZV	-BV	SSV	-LS	N/A	N/A	-C1
3/8"	-E	-TV	-ZV	-BV	SSV	-LS	N/A	N/A	-C1
1/2"	-E	-TV	-ZV	-BV	SSV	-LS	N/A	N/A	-C1
3/4"	-E	-TV	-ZV	-BV	SSV	-LS	N/A	N/A	-C1
1"	-E	-TV	-ZV	-BV	SSV	-LS	N/A	N/A	-C1
1-1/4"	-E		-ZV	-BV	SSV	-LS	N/A	N/A	-C1
1-1/2"	-E		-ZV	-BV	SSV	-LS	N/A	N/A	-C1
2"	-E		-ZV	-BV	SSV	-LS	N/A	N/A	-C1

Perfil Serie-V Largo

Medida	A	B
1-1/4"	1.34	0.43
1-1/2"	1.70	0.40
2"	2.23	0.49

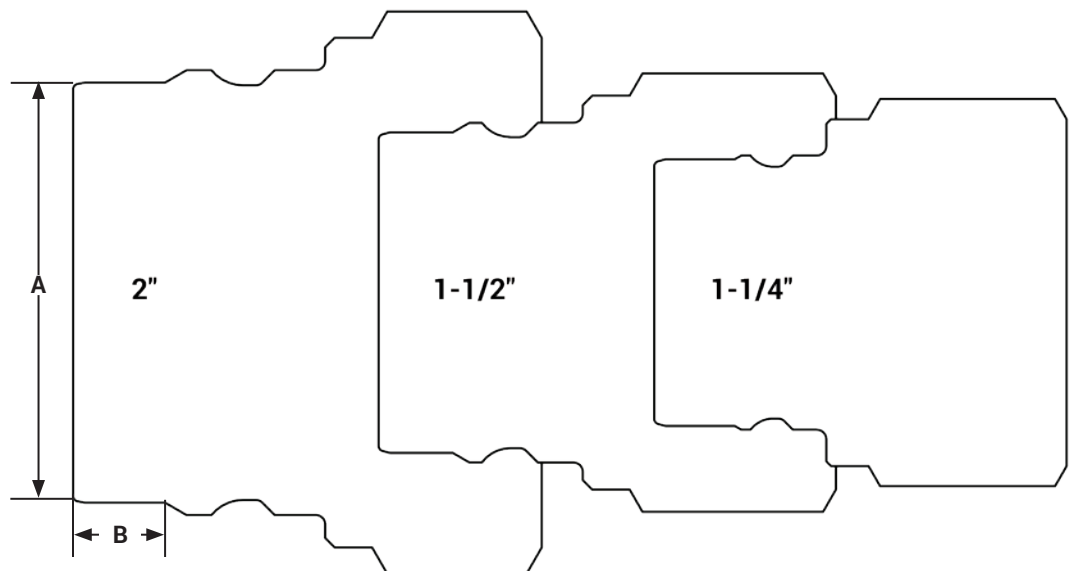

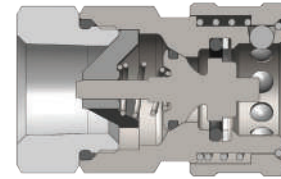
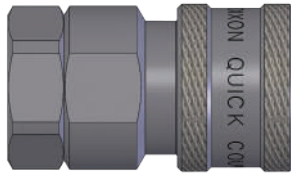

Serie-V Cople con Válvula MIL-C-51234 (Roscas Hembra)

Medida	Serie-V Cople con Válvula MIL-C-51234 (Roscas Hembra)							
	Detalle			Medida		DE Máximo		Hex pulg
	# Parte	Roscas	Material	pulg	mm	pulg	mm	
1/4"	2VF1	1/8" - 27 NPTF	acero	1.68	42.7	0.99	25.1	7/8"
	2VF2	1/4" - 18 NPTF	acero	1.68	42.7	0.99	25.1	7/8"
	2VF2-B	1/4" - 18 NPTF	latón	1.68	42.7	0.99	25.1	7/8"
	2VF2-SS	1/4" - 18 NPTF	A.I. 316	1.68	42.7	0.99	25.1	7/8"
	2VBF2	1/4" - 19 BSPP	acero	1.81	46.0	0.99	25.1	7/8"
	2VBF2-B	1/4" - 19 BSPP	latón	1.81	46.0	0.99	25.1	7/8"
	2VBF2-SS	1/4" - 19 BSPP	A.I. 316	1.81	46.0	0.99	25.1	7/8"
	2VOF2	7/16" - 20 ORB	acero	1.81	46.0	0.99	25.1	7/8"
3/8"	3VF3	3/8" - 18 NPTF	acero	1.94	49.3	1.18	30.0	1"
	3VF3-B	3/8" - 18 NPTF	latón	1.94	49.3	1.18	30.0	1"
	3VF3-SS	3/8" - 18 NPTF	A.I. 316	1.94	49.3	1.18	30.0	1"
	3VBF3	3/8" - 19 BSPP	acero	2.01	51.1	1.18	30.0	1"
	3VBF3-B	3/8" - 19 BSPP	latón	2.01	51.1	1.18	30.0	1"
	3VBF3-SS	3/8" - 19 BSPP	A.I. 316	2.01	51.1	1.18	30.0	1"
		3VOF3	9/16" - 18 ORB	acero	2.01	51.1	1.18	30.0
	3VF4	1/2" - 14 NPTF	acero	2.01	51.1	1.18	30.0	1"
1/2"	4VF4	1/2" - 14 NPTF	acero	2.13	54.1	1.36	34.5	1-3/16"
	4VF4-B	1/2" - 14 NPTF	latón	2.13	54.1	1.36	34.5	1-3/16"
	4VF4-SS	1/2" - 14 NPTF	A.I. 316	2.13	54.1	1.36	34.5	1-3/16"
	4VBF4	1/2" - 14 BSPP	acero	2.13	54.1	1.36	34.5	1-3/16"
	4VBF4-B	1/2" - 14 BSPP	latón	2.13	54.1	1.36	34.5	1-3/16"
	4VBF4-SS	1/2" - 14 BSPP	A.I. 316	2.13	54.1	1.36	34.5	1-3/16"
		4VOF4	3/4" - 16 ORB	acero	2.13	54.1	1.36	34.5
3/4"	4VF6	3/4" - 14 NPTF	acero	2.13	54.1	1.36	34.5	1-3/16"
	6VF6	3/4" - 14 NPTF	acero	2.47	62.7	1.67	42.4	1-1/2"
	6VF6-B	3/4" - 14 NPTF	latón	2.47	62.7	1.67	42.4	1-1/2"
	6VF6-SS	3/4" - 14 NPTF	A.I. 316	2.47	62.7	1.67	42.4	1-1/2"
	6VBF6	3/4" - 14 BSPP	acero	2.96	75.2	1.67	42.4	1-1/2"
	6VBF6-B	3/4" - 14 BSPP	latón	2.96	75.2	1.67	42.4	1-1/2"
	6VBF6-SS	3/4" - 14 BSPP	A.I. 316	2.96	75.2	1.67	42.4	1-1/2"
	6VOF6	1-1/16" - 12 ORB	acero	2.96	75.2	1.67	42.4	1-1/2"
1"	8VF8	1" - 11-1/2 NPTF	acero	2.70	68.6	2.06	52.3	1-7/8"
	8VF8-B	1" - 11-1/2 NPTF	latón	2.70	68.6	2.06	52.3	1-7/8"
	8VF8-SS	1" - 11-1/2 NPTF	A.I. 316	2.70	68.6	2.06	52.3	1-7/8"
	8VBF8	1" - 11 BSPP	acero	2.97	75.4	2.06	52.3	1-7/8"
	8VBF8-B	1" - 11 BSPP	latón	2.97	75.4	2.06	52.3	1-7/8"
	8VBF8-SS	1" - 11 BSPP	A.I. 316	2.97	75.4	2.06	52.3	1-7/8"
		8VOF8	1-5/16" - 12 ORB	acero	2.97	75.4	2.06	52.3

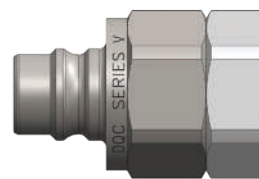
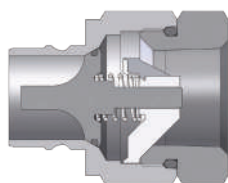

Medida	Serie-V Niple con Válvula MIL-C-51234 (Roscas Hembra)							
	Detalle			Medida		DE Máximo		Hex pulg
	# Parte	Roscas	Material	pulg	mm	pulg	mm	
1/4"	V2F1	1/8" - 27 NPTF	acero	1.62	41.1	0.97	24.6	7/8"
	V2F2	1/4" - 18 NPTF	acero	1.62	41.1	0.97	24.6	7/8"
	V2F2-B	1/4" - 18 NPTF	latón	1.62	41.1	0.97	24.6	7/8"
	V2F2-SS	1/4" - 18 NPTF	A.I. 316	1.62	41.1	0.97	24.6	7/8"
	V2BF2	1/4" - 19 BSPP	acero	1.75	44.5	0.97	24.6	7/8"
	V2BF2-B	1/4" - 19 BSPP	latón	1.75	44.5	0.97	24.6	7/8"
	V2BF2-SS	1/4" - 19 BSPP	A.I. 316	1.75	44.5	0.97	24.6	7/8"
V2OF2	7/16" - 20 ORB	acero	1.75	44.5	0.97	24.6	7/8"	
3/8"	V3F3	3/8" - 18 NPTF	acero	1.87	47.5	1.10	27.9	1"
	V3F3-B	3/8" - 18 NPTF	latón	1.87	47.5	1.10	27.9	1"
	V3F3-SS	3/8" - 18 NPTF	A.I. 316	1.87	47.5	1.10	27.9	1"
	V3BF3	3/8" - 19 BSPP	acero	1.94	49.3	1.10	27.9	1"
	V3BF3-B	3/8" - 19 BSPP	latón	1.94	49.3	1.10	27.9	1"
	V3BF3-SS	3/8" - 19 BSPP	A.I. 316	1.94	49.3	1.10	27.9	1"
	V3OF3	9/16" - 18 ORB	acero	1.94	49.3	1.10	27.9	1"
V3F4	1/2" - 14 NPTF	acero	1.94	49.3	1.10	27.9	1"	
1/2"	V4F4	1/2" - 14 NPTF	acero	1.99	50.5	1.31	33.3	1-3/16"
	V4F4-B	1/2" - 14 NPTF	latón	1.99	50.5	1.31	33.3	1-3/16"
	V4F4-SS	1/2" - 14 NPTF	A.I. 316	1.99	50.5	1.31	33.3	1-3/16"
	V4BF4	1/2" - 14 BSPP	acero	1.99	50.5	1.31	33.3	1-3/16"
	V4BF4-B	1/2" - 14 BSPP	latón	1.99	50.5	1.31	33.3	1-3/16"
	V4BF4-SS	1/2" - 14 BSPP	A.I. 316	1.99	50.5	1.31	33.3	1-3/16"
	V4OF4	3/4" - 16 ORB	acero	1.99	50.5	1.31	33.3	1-3/16"
V4F6	3/4" - 14 NPTF	acero	1.99	50.5	1.31	33.3	1-3/16"	
3/4"	V6F6	3/4" - 14 NPTF	acero	2.31	58.7	1.65	41.9	1-1/2"
	V6F6-B	3/4" - 14 NPTF	latón	2.31	58.7	1.65	41.9	1-1/2"
	V6F6-SS	3/4" - 14 NPTF	A.I. 316	2.31	58.7	1.65	41.9	1-1/2"
	V6BF6	3/4" - 14 BSPP	acero	2.80	71.1	1.65	41.9	1-1/2"
	V6BF6-B	3/4" - 14 BSPP	latón	2.80	71.1	1.65	41.9	1-1/2"
	V6BF6-SS	3/4" - 14 BSPP	A.I. 316	2.80	71.1	1.65	41.9	1-1/2"
	V6OF6	1-1/16" - 12 ORB	acero	2.80	71.1	1.65	41.9	1-1/2"
1"	V8F8	1" - 11-1/2 NPTF	acero	2.60	66.0	2.06	52.3	1-7/8"
	V8F8-B	1" - 11-1/2 NPTF	latón	2.60	66.0	2.06	52.3	1-7/8"
	V8F8-SS	1" - 11-1/2 NPTF	A.I. 316	2.60	66.0	2.06	52.3	1-7/8"
	V8BF8	1" - 11 BSPP	acero	2.87	72.9	2.06	52.3	1-7/8"
	V8BF8-B	1" - 11 BSPP	latón	2.87	72.9	2.06	52.3	1-7/8"
	V8BF8-SS	1" - 11 BSPP	A.I. 316	2.87	72.9	2.06	52.3	1-7/8"
	V8OF8	1-5/16" - 12 ORB	acero	2.85	72.6	2.06	52.3	1-7/8"

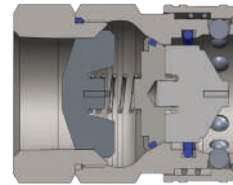
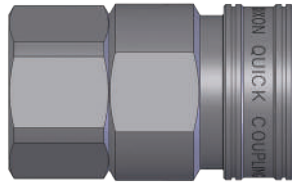

Serie-V Cople con Válvula MIL-C-51234 (Roscas Hembra)

Medida	Serie-V Cople con Válvula MIL-C-51234 (Roscas Hembra)							
	Detalle			Medida		DE Máximo		Hex pulg
	# Parte	Roscas	Material	pulg	mm	pulg	mm	
1-1/4"	10VF10	1-1/4" - 11-1/2 NPTF	acero	3.54	89.9	2.19	55.6	2"
	10VF10-B	1-1/4" - 11-1/2 NPTF	latón	3.54	89.9	2.19	55.6	2"
	10VF10-SS	1-1/4" - 11-1/2 NPTF	A.I. 316	3.54	89.9	2.19	55.6	2"
	10VBF10	1-1/4" - 11 BSPP	acero	3.54	89.9	2.19	55.6	2"
	10VBF10-B	1-1/4" - 11 BSPP	latón	3.54	89.9	2.19	55.6	2"
	10VBF10-SS	1-1/4" - 11 BSPP	A.I. 316	3.54	89.9	2.19	55.6	2"
	10VOF10	1-5/8" - 12 ORB	acero	3.54	89.9	2.19	55.6	2"
1-1/2"	12VF12	1-1/2" - 11-1/2 NPTF	acero	3.27	83.1	2.74	69.6	2-1/2"
	12VF12-B	1-1/2" - 11-1/2 NPTF	latón	3.27	83.1	2.74	69.6	2-1/2"
	12VF12-SS	1-1/2" - 11-1/2 NPTF	A.I. 316	3.27	83.1	2.74	69.6	2-1/2"
	12VBF12	1-1/2" - 11 BSPP	acero	3.27	83.1	2.74	69.6	2-1/2"
	12VBF12-B	1-1/2" - 11 BSPP	latón	3.27	83.1	2.74	69.6	2-1/2"
	12VBF12-SS	1-1/2" - 11 BSPP	A.I. 316	3.27	83.1	2.74	69.6	2-1/2"
	12VOF12	1-7/8" - 12 ORB	acero	3.27	83.1	2.74	69.6	2-1/2"
2"	16VF16	2" - 11-1/2 NPTF	acero	3.92	99.6	3.83	97.3	3-1/2"
	16VF16-B	2" - 11-1/2 NPTF	latón	3.92	99.6	3.83	97.3	3-1/2"
	16VF16-SS	2" - 11-1/2 NPTF	A.I. 316	3.92	99.6	3.83	97.3	3-1/2"
	16VBF16	2" - 11 BSPP	acero	3.92	99.6	3.83	97.3	3-1/2"
	16VBF16-B	2" - 11 BSPP	latón	3.92	99.6	3.83	97.3	3-1/2"
	16VBF16-SS	2" - 11 BSPP	A.I. 316	3.92	99.6	3.83	97.3	3-1/2"

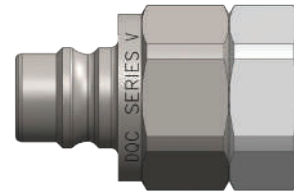
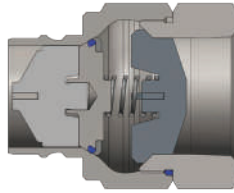

Medida	Serie-V Niple con Válvula MIL-C-51234 (Roscas Hembra)							
	Detalle			Medida		DE Máximo		Hex pulg
	# Parte	Roscas	Material	pulg	mm	pulg	mm	
1-1/4"	V10F10	1-1/4" - 11-1/2 NPTF	acero	3.41	86.6	2.19	55.6	2"
	V10F10-B	1-1/4" - 11-1/2 NPTF	latón	3.41	86.6	2.19	55.6	2"
	V10F10-SS	1-1/4" - 11-1/2 NPTF	A.I. 316	3.41	86.6	2.19	55.6	2"
	V10BF10	1-1/4" - 11 BSPP	acero	3.41	86.6	2.19	55.6	2"
	V10BF10-B	1-1/4" - 11 BSPP	latón	3.41	86.6	2.19	55.6	2"
	V10BF10-SS	1-1/4" - 11 BSPP	A.I. 316	3.41	86.6	2.19	55.6	2"
	V100F10	1-5/8" - 12 ORB	acero	3.41	86.6	2.19	55.6	2"
1-1/2"	V12F12	1-1/2" - 11-1/2 NPTF	acero	3.35	79.0	2.74	69.6	2-1/2"
	V12F12-B	1-1/2" - 11-1/2 NPTF	latón	3.35	79.0	2.74	69.6	2-1/2"
	V12F12-SS	1-1/2" - 11-1/2 NPTF	A.I. 316	3.35	79.0	2.74	69.6	2-1/2"
	V12BF12	1-1/2" - 11 BSPP	acero	3.35	79.0	2.74	69.6	2-1/2"
	V12BF12-B	1-1/2" - 11 BSPP	latón	3.35	79.0	2.74	69.6	2-1/2"
	V12BF12-SS	1-1/2" - 11 BSPP	A.I. 316	3.35	79.0	2.74	69.6	2-1/2"
	V120F12	1-7/8" - 12 ORB	acero	3.35	79.0	2.74	69.6	2-1/2"
2"	V16F16	2" - 11-1/2 NPTF	acero	3.72	94.5	3.83	97.3	3-1/2"
	V16F16-B	2" - 11-1/2 NPTF	latón	3.72	94.5	3.83	97.3	3-1/2"
	V16F16-SS	2" - 11-1/2 NPTF	A.I. 316	3.72	94.5	3.83	97.3	3-1/2"
	V16BF16	2" - 11 BSPP	acero	3.72	94.5	3.83	97.3	3-1/2"
	V16BF16-B	2" - 11 BSPP	latón	3.72	94.5	3.83	97.3	3-1/2"
	V16BF16-SS	2" - 11 BSPP	A.I. 316	3.72	94.5	3.83	97.3	3-1/2"

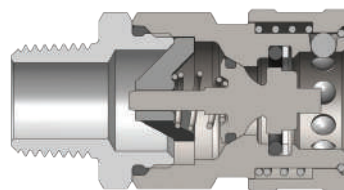
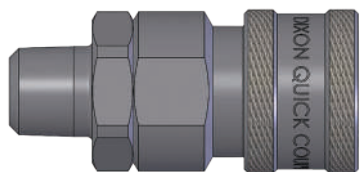

Serie-V Cople con Válvula MIL-C-51234 (Roscas Macho)

Medida	Serie-V Cople con Válvula MIL-C-51234 (Roscas Macho)							
	Detalle			Medida		DE Máximo		Hex pulg
	# Parte	Roscas	Material	pulg	mm	pulg	mm	
1/4"	2VM1	1/8" - 27 NPTF	acero	2.12	53.8	0.99	25.1	7/8"
	2VM2	1/4" - 18 NPTF	acero	2.12	53.8	0.99	25.1	7/8"
	2VM2-B	1/4" - 18 NPTF	latón	2.12	53.8	0.99	25.1	7/8"
	2VM2-SS	1/4" - 18 NPTF	A.I. 316	2.12	53.8	0.99	25.1	7/8"
3/8"	3VM3	3/8" - 18 NPTF	acero	2.32	58.9	1.18	30.0	1"
	3VM3-B	3/8" - 18 NPTF	latón	2.32	58.9	1.18	30.0	1"
	3VM3-SS	3/8" - 18 NPTF	A.I. 316	2.32	58.9	1.18	30.0	1"
1/2"	4VM4	1/2" - 14 NPTF	acero	2.54	64.5	1.36	34.5	1-3/16"
	4VM4-B	1/2" - 14 NPTF	latón	2.54	64.5	1.36	34.5	1-3/16"
	4VM4-SS	1/2" - 14 NPTF	A.I. 316	2.54	64.5	1.36	34.5	1-3/16"
3/4"	6VM6	3/4" - 14 NPTF	acero	3.07	78.0	1.67	42.4	1-1/2"
	6VM6-B	3/4" - 14 NPTF	latón	3.07	78.0	1.67	42.4	1-1/2"
	6VM6-SS	3/4" - 14 NPTF	A.I. 316	3.07	78.0	1.67	42.4	1-1/2"
1"	8VM8	1" - 11-1/2 NPTF	acero	3.32	84.3	2.06	52.3	1-7/8"
	8VM8-B	1" - 11-1/2 NPTF	latón	3.32	84.3	2.06	52.3	1-7/8"
	8VM8-SS	1" - 11-1/2 NPTF	A.I. 316	3.32	84.3	2.06	52.3	1-7/8"
1-1/4"	10VM10	1-1/4" - 11-1/2 NPTF	acero	3.59	91.2	2.19	55.6	2"
	10VM10-B	1-1/4" - 11-1/2 NPTF	latón	3.59	91.2	2.19	55.6	2"
	10VM10-SS	1-1/4" - 11-1/2 NPTF	A.I. 316	3.59	91.2	2.19	55.6	2"
1-1/2"	12VM12	1-1/2" - 11-1/2 NPTF	acero	4.01	101.9	2.74	69.6	2-1/2"
	12VM12-B	1-1/2" - 11-1/2 NPTF	latón	4.01	101.9	2.74	69.6	2-1/2"
	12VM12-SS	1-1/2" - 11-1/2 NPTF	A.I. 316	4.01	101.9	2.74	69.6	2-1/2"
2"	16VM16	2" - 11-1/2 NPTF	acero	4.54	115.3	3.83	97.3	3-1/2"
	16VM16-B	2" - 11-1/2 NPTF	latón	4.54	115.3	3.83	97.3	3-1/2"
	16VM16-SS	2" - 11-1/2 NPTF	A.I. 316	4.54	115.3	3.83	97.3	3-1/2"

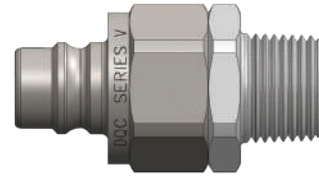
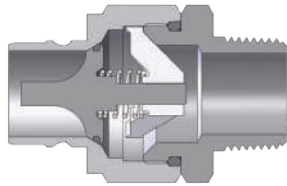

Medida	Serie-V Niple con Válvula MIL-C-51234 (Roscas Macho)							
	Detalle			Medida		DE Máximo		Hex pulg
	# Parte	Roscas	Material	pulg	mm	pulg	mm	
1/4"	V2M1	1/8" - 27 NPTF	acero	2.06	52.3	0.97	24.6	7/8"
	V2M2	1/4" - 18 NPTF	acero	2.06	52.3	0.97	24.6	7/8"
	V2M2-B	1/4" - 18 NPTF	latón	2.06	52.3	0.97	24.6	7/8"
	V2M2-SS	1/4" - 18 NPTF	A.I. 316	2.06	52.3	0.97	24.6	7/8"
3/8"	V3M3	3/8" - 18 NPTF	acero	2.25	57.2	1.10	27.9	1"
	V3M3-B	3/8" - 18 NPTF	latón	2.25	57.2	1.10	27.9	1"
	V3M3-SS	3/8" - 18 NPTF	A.I. 316	2.25	57.2	1.10	27.9	1"
1/2"	V4M4	1/2" - 14 NPTF	acero	2.40	61.0	1.31	33.3	1-3/16"
	V4M4-B	1/2" - 14 NPTF	latón	2.40	61.0	1.31	33.3	1-3/16"
	V4M4-SS	1/2" - 14 NPTF	A.I. 316	2.40	61.0	1.31	33.3	1-3/16"
3/4"	V6M6	3/4" - 14 NPTF	acero	2.91	73.9	1.65	41.9	1-1/2"
	V6M6-B	3/4" - 14 NPTF	latón	2.91	73.9	1.65	41.9	1-1/2"
	V6M6-SS	3/4" - 14 NPTF	A.I. 316	2.91	73.9	1.65	41.9	1-1/2"
1"	V8M8	1" - 11-1/2 NPTF	acero	3.22	81.8	2.06	52.3	1-7/8"
	V8M8-B	1" - 11-1/2 NPTF	latón	3.22	81.8	2.06	52.3	1-7/8"
	V8M8-SS	1" - 11-1/2 NPTF	A.I. 316	3.22	81.8	2.06	52.3	1-7/8"
1-1/4"	V10M10	1-1/4" - 11-1/2 NPTF	acero	3.46	87.9	2.19	55.6	2"
	V10M10-B	1-1/4" - 11-1/2 NPTF	latón	3.46	87.9	2.19	55.6	2"
	V10M10-SS	1-1/4" - 11-1/2 NPTF	A.I. 316	3.46	87.9	2.19	55.6	2"
1-1/2"	V12M12	1-1/2" - 11-1/2 NPTF	acero	3.85	97.8	2.74	69.6	2-1/2"
	V12M12-B	1-1/2" - 11-1/2 NPTF	latón	3.85	97.8	2.74	69.6	2-1/2"
	V12M12-SS	1-1/2" - 11-1/2 NPTF	A.I. 316	3.85	97.8	2.74	69.6	2-1/2"
2"	V16M16	2" - 11-1/2 NPTF	acero	4.34	110.2	3.83	97.3	3-1/2"
	V16M16-B	2" - 11-1/2 NPTF	latón	4.34	110.2	3.83	97.3	3-1/2"
	V16M16-SS	2" - 11-1/2 NPTF	A.I. 316	4.34	110.2	3.83	97.3	3-1/2"

Coples Hidráulicos: Serie-V

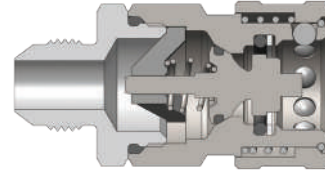
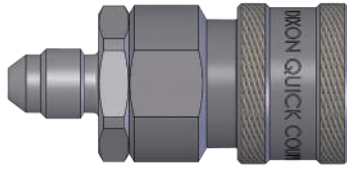

Serie-V Cople con Válvula MIL-C-51234 (Roscas Macho JIC)

Medida	Serie-V Cople con Válvula MIL-C-51234 (Roscas Macho JIC)							
	Detalle			Medida		DE Máximo		Hex pulg
	# Parte	Roscas	Material	pulg	mm	pulg	mm	
1/4"	2VJM2	7/16" - 20 JIC	acero	2.12	53.8	0.99	25.1	7/8"
3/8"	3VJM3	9/16" - 18 JIC	acero	2.32	58.9	1.18	30.0	1"
1/2"	4VJM4	3/4" - 16 JIC	acero	2.54	64.5	1.36	34.5	1-3/16"
3/4"	6VJM6	1-1/16" - 12 JIC	acero	3.07	78.0	1.67	42.4	1-1/2"
1"	8VJM8	1-5/16" - 12 JIC	acero	3.32	84.3	2.06	52.3	1-7/8"
1-1/4"	10VJM10	1-5/8" - 12 JIC	acero	3.59	91.2	2.19	55.6	2"

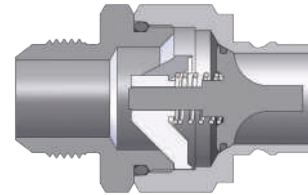
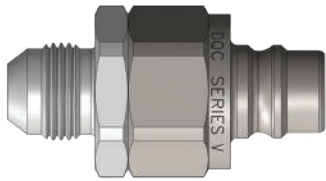

Serie-V Niple con Válvula MIL-C-51234 (Roscas Macho JIC)

Medida	Serie-V Niple con Válvula MIL-C-51234 (Roscas Macho JIC)							
	Detalle			Medida		DE Máximo		Hex pulg
	# Parte	Roscas	Material	pulg	mm	pulg	mm	
1/4"	V2JM2	7/16" - 20 JIC	acero	2.06	52.3	0.97	24.6	7/8"
3/8"	V3JM3	9/16" - 18 JIC	acero	2.25	57.2	1.1	27.9	1"
1/2"	V4JM4	3/4" - 16 JIC	acero	2.40	61.0	1.31	33.3	1-3/16"
3/4"	V6JM6	1-1/16" - 12 JIC	acero	2.91	73.9	1.65	41.9	1-1/2"
1"	V8JM8	1-5/16" - 12 JIC	acero	3.22	81.8	2.06	52.3	1-7/8"
1-1/4"	V10JM10	1-5/8" - 12 JIC	acero	3.46	87.9	2.19	55.6	2"

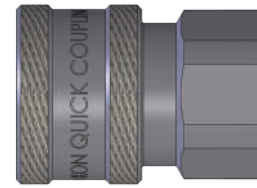
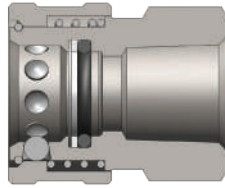

Serie-V Cople sin Válvula MIL-C-51234 (Roscas Hembra)								
Medida	Detalle			Medida		DE Máximo		Hex pulg
	# Parte	Roscas	Material	pulg	mm	pulg	mm	
1/4"	2VF2-E	1/4" - 18 NPTF	acero	1.36	34.5	0.99	25.1	7/8"
	2VF2-B-E	1/4" - 18 NPTF	latón	1.36	34.5	0.99	25.1	7/8"
	2VF2-SS-E	1/4" - 18 NPTF	A.I. 316	1.36	34.5	0.99	25.1	7/8"
	2VBF2-E	1/4" - 19 BSPP	acero	1.36	34.5	0.99	25.1	7/8"
	2VBF2-B-E	1/4" - 19 BSPP	latón	1.36	34.5	0.99	25.1	7/8"
	2VBF2-SS-E	1/4" - 19 BSPP	A.I. 316	1.36	34.5	0.99	25.1	7/8"
3/8"	3VF3-E	3/8" - 18 NPTF	acero	1.50	38.1	1.18	30.0	7/8"
	3VF3-B-E	3/8" - 18 NPTF	latón	1.50	38.1	1.18	30.0	7/8"
	3VF3-SS-E	3/8" - 18 NPTF	A.I. 316	1.50	38.1	1.18	30.0	7/8"
	3VBF3-E	3/8" - 19 BSPP	acero	1.50	38.1	1.18	30.0	7/8"
	3VBF3-B-E	3/8" - 19 BSPP	latón	1.50	38.1	1.18	30.0	7/8"
	3VBF3-SS-E	3/8" - 19 BSPP	A.I. 316	1.50	38.1	1.18	30.0	7/8"
1/2"	4VF4-E	1/2" - 14 NPTF	acero	1.64	41.7	1.37	34.8	1-3/16"
	4VF4-B-E	1/2" - 14 NPTF	latón	1.64	41.7	1.37	34.8	1-3/16"
	4VF4-SS-E	1/2" - 14 NPTF	A.I. 316	1.64	41.7	1.37	34.8	1-3/16"
	4VBF4-E	1/2" - 14 BSPP	acero	1.64	41.7	1.37	34.8	1-3/16"
	4VBF4-B-E	1/2" - 14 BSPP	latón	1.64	41.7	1.37	34.8	1-3/16"
	4VBF4-SS-E	1/2" - 14 BSPP	A.I. 316	1.64	41.7	1.37	34.8	1-3/16"
3/4"	6VF6-E	3/4" - 14 NPTF	acero	1.96	49.8	1.67	42.4	1-1/2"
	6VF6-B-E	3/4" - 14 NPTF	latón	1.96	49.8	1.67	42.4	1-1/2"
	6VF6-SS-E	3/4" - 14 NPTF	A.I. 316	1.96	49.8	1.67	42.4	1-1/2"
	6VBF6-E	3/4" - 14 BSPP	acero	1.96	49.8	1.67	42.4	1-1/2"
	6VBF6-B-E	3/4" - 14 BSPP	latón	1.96	49.8	1.67	42.4	1-1/2"
	6VBF6-SS-E	3/4" - 14 BSPP	A.I. 316	1.96	49.8	1.67	42.4	1-1/2"
1"	8VF8-E	1" - 11-1/2 NPTF	acero	2.10	53.3	1.99	50.5	1-13/16"
	8VF8-B-E	1" - 11-1/2 NPTF	latón	2.10	53.3	1.99	50.5	1-13/16"
	8VF8-SS-E	1" - 11-1/2 NPTF	A.I. 316	2.10	53.3	1.99	50.5	1-13/16"
	8VBF8-E	1" - 11 BSPP	acero	2.10	53.3	1.99	50.5	1-13/16"
	8VBF8-B-E	1" - 11 BSPP	latón	2.10	53.3	1.99	50.5	1-13/16"
	8VBF8-SS-E	1" - 11 BSPP	A.I. 316	2.10	53.3	1.99	50.5	1-13/16"
1-1/4"	10VF10-E	1-1/4" - 11-1/2 NPTF	acero	2.28	57.9	2.19	55.6	2"
	10VF10-B-E	1-1/4" - 11-1/2 NPTF	latón	2.28	57.9	2.19	55.6	2"
	10VF10-SS-E	1-1/4" - 11-1/2 NPTF	A.I. 316	2.28	57.9	2.19	55.6	2"
	10VBF10-E	1-1/4" - 11 BSPP	acero	2.28	57.9	2.19	55.6	2"
	10VBF10-B-E	1-1/4" - 11 BSPP	latón	2.28	57.9	2.19	55.6	2"
	10VBF10-SS-E	1-1/4" - 11 BSPP	A.I. 316	2.28	57.9	2.19	55.6	2"
1-1/2"	12VF12-E	1-1/2" - 11-1/2 NPTF	acero	2.57	65.3	2.74	69.6	2-1/2"
	12VF12-B-E	1-1/2" - 11-1/2 NPTF	latón	2.57	65.3	2.74	69.6	2-1/2"
	12VF12-SS-E	1-1/2" - 11-1/2 NPTF	A.I. 316	2.57	65.3	2.74	69.6	2-1/2"
2"	16VF16-E	2" - 11-1/2 NPTF	acero	2.48	63.0	3.56	90.4	3-1/4"
	16VF16-B-E	2" - 11-1/2 NPTF	latón	2.48	63.0	3.56	90.4	3-1/4"
	16VF16-SS-E	2" - 11-1/2 NPTF	A.I. 316	2.48	63.0	3.56	90.4	3-1/4"

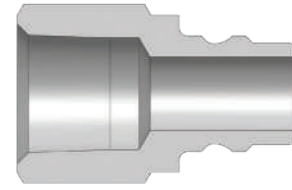
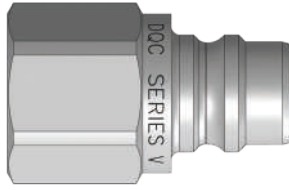

Serie-V Niple sin Válvula MIL-C-51234 (Roscas Hembra)

Medida	Detalle			Medida		DE Máximo		Hex pulg
	# Parte	Roscas	Material	pulg	mm	pulg	mm	
1/4"	V2F2-E	1/4" - 18 NPTF	acero	1.27	32.3	0.69	17.5	5/8"
	V2F2-B-E	1/4" - 18 NPTF	latón	1.27	32.3	0.69	17.5	5/8"
	V2F2-SS-E	1/4" - 18 NPTF	A.I. 316	1.27	32.3	0.69	17.5	5/8"
	V2BF2-E	1/4" - 19 BSPP	acero	1.27	32.3	0.69	17.5	5/8"
	V2BF2-B-E	1/4" - 19 BSPP	latón	1.27	32.3	0.69	17.5	5/8"
	V2BF2-SS-E	1/4" - 19 BSPP	A.I. 316	1.27	32.3	0.69	17.5	5/8"
3/8"	V3F3-E	3/8" - 18 NPTF	acero	1.41	35.8	0.90	22.9	13/16"
	V3F3-B-E	3/8" - 18 NPTF	latón	1.41	35.8	0.90	22.9	13/16"
	V3F3-SS-E	3/8" - 18 NPTF	A.I. 316	1.41	35.8	0.90	22.9	13/16"
	V3BF3-E	3/8" - 19 BSPP	acero	1.41	35.8	0.90	22.9	13/16"
	V3BF3-B-E	3/8" - 19 BSPP	latón	1.41	35.8	0.90	22.9	13/16"
1/2"	V4F4-E	1/2" - 14 NPTF	acero	1.72	43.7	1.10	27.9	1"
	V4F4-B-E	1/2" - 14 NPTF	latón	1.72	43.7	1.10	27.9	1"
	V4F4-SS-E	1/2" - 14 NPTF	A.I. 316	1.72	43.7	1.10	27.9	1"
	V4BF4-E	1/2" - 14 BSPP	acero	1.72	43.7	1.10	27.9	1"
	V4BF4-B-E	1/2" - 14 BSPP	latón	1.72	43.7	1.10	27.9	1"
	V4BF4-SS-E	1/2" - 14 BSPP	A.I. 316	1.72	43.7	1.10	27.9	1"
3/4"	V6F6-E	3/4" - 14 NPTF	acero	1.86	47.2	1.31	33.3	1-3/16"
	V6F6-B-E	3/4" - 14 NPTF	latón	1.86	47.2	1.31	33.3	1-3/16"
	V6F6-SS-E	3/4" - 14 NPTF	A.I. 316	1.86	47.2	1.31	33.3	1-3/16"
	V6BF6-E	3/4" - 14 BSPP	acero	1.86	47.2	1.31	33.3	1-3/16"
	V6BF6-B-E	3/4" - 14 BSPP	latón	1.86	47.2	1.31	33.3	1-3/16"
	V6BF6-SS-E	3/4" - 14 BSPP	A.I. 316	1.86	47.2	1.31	33.3	1-3/16"
1"	V8F8-E	1" - 11-1/2 NPTF	acero	2.08	52.8	1.65	41.9	1-1/2"
	V8F8-B-E	1" - 11-1/2 NPTF	latón	2.08	52.8	1.65	41.9	1-1/2"
	V8F8-SS-E	1" - 11-1/2 NPTF	A.I. 316	2.08	52.8	1.65	41.9	1-1/2"
	V8BF8-E	1" - 11 BSPP	acero	2.08	52.8	1.65	41.9	1-1/2"
	V8BF8-B-E	1" - 11 BSPP	latón	2.08	52.8	1.65	41.9	1-1/2"
	V8BF8-SS-E	1" - 11 BSPP	A.I. 316	2.08	52.8	1.65	41.9	1-1/2"
1-1/4"	V10F10-E	1-1/4" - 11-1/2 NPTF	acero	2.22	56.4	2.06	52.3	1-7/8"
	V10F10-B-E	1-1/4" - 11-1/2 NPTF	latón	2.22	56.4	2.06	52.3	1-7/8"
	V10F10-SS-E	1-1/4" - 11-1/2 NPTF	A.I. 316	2.22	56.4	2.06	52.3	1-7/8"
	V10BF10-E	1-1/4" - 11 BSPP	acero	2.22	56.4	2.06	52.3	1-7/8"
	V10BF10-B-E	1-1/4" - 11 BSPP	latón	2.22	56.4	2.06	52.3	1-7/8"
	V10BF10-SS-E	1-1/4" - 11 BSPP	A.I. 316	2.22	56.4	2.06	52.3	1-7/8"
1-1/2"	V12F12-E	1-1/2" - 11-1/2 NPTF	acero	2.44	62.0	2.33	59.2	2-1/8"
	V12F12-B-E	1-1/2" - 11-1/2 NPTF	latón	2.44	62.0	2.33	59.2	2-1/8"
	V12F12-SS-E	1-1/2" - 11-1/2 NPTF	A.I. 316	2.44	62.0	2.33	59.2	2-1/8"
2"	V16F16-E	2" - 11-1/2 NPTF	acero	2.60	66.0	3.01	76.5	2-3/4"
	V16F16-B-E	2" - 11-1/2 NPTF	latón	2.60	66.0	3.01	76.5	2-3/4"
	V16F16-SS-E	2" - 11-1/2 NPTF	A.I. 316	2.60	66.0	3.01	76.5	2-3/4"

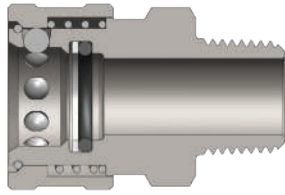

Medida	Serie-V Cople sin Válvula MIL-C-51234 (Roscas Macho)							
	Detalle			Medida		DE Máximo		Hex pulg
	# Parte	Roscas	Material	pulg	mm	pulg	mm	
1/4"	2VM2-E	1/4" - 18 NPTF	acero	1.82	46.2	0.99	25.1	5/8"
	2VM2-B-E	1/4" - 18 NPTF	latón	1.82	46.2	0.99	25.1	5/8"
	2VM2-SS-E	1/4" - 18 NPTF	A.I. 316	1.82	46.2	0.99	25.1	5/8"
3/8"	3VM3-E	3/8" - 18 NPTF	acero	1.76	44.7	1.18	30.0	13/16"
	3VM3-B-E	3/8" - 18 NPTF	latón	1.76	44.7	1.18	30.0	13/16"
	3VM3-SS-E	3/8" - 18 NPTF	A.I. 316	1.76	44.7	1.18	30.0	13/16"
1/2"	4VM4-E	1/2" - 14 NPTF	acero	2.03	51.6	1.37	34.8	1"
	4VM4-B-E	1/2" - 14 NPTF	latón	2.03	51.6	1.37	34.8	1"
	4VM4-SS-E	1/2" - 14 NPTF	A.I. 316	2.03	51.6	1.37	34.8	1"
3/4"	6VM6-E	3/4" - 14 NPTF	acero	2.29	58.2	1.67	42.4	1-3/16"
	6VM6-B-E	3/4" - 14 NPTF	latón	2.29	58.2	1.67	42.4	1-3/16"
	6VM6-SS-E	3/4" - 14 NPTF	A.I. 316	2.29	58.2	1.67	42.4	1-3/16"
1"	8VM8-E	1" - 11-1/2 NPTF	acero	2.39	60.7	1.99	50.5	1-1/2"
	8VM8-B-E	1" - 11-1/2 NPTF	latón	2.39	60.7	1.99	50.5	1-1/2"
	8VM8-SS-E	1" - 11-1/2 NPTF	A.I. 316	2.39	60.7	1.99	50.5	1-1/2"
1-1/4"	10VM10-E	1-1/4" - 11-1/2 NPTF	acero	2.78	70.6	2.19	55.6	1-7/8"
	10VM10-SS-E	1-1/4" - 11-1/2 NPTF	A.I. 316	2.78	70.6	2.19	55.6	1-7/8"
1-1/2"	12VM12-E	1-1/2" - 11-1/2 NPTF	acero	3.08	78.2	2.74	69.6	2-1/8"
	12VM12-SS-E	1-1/2" - 11-1/2 NPTF	A.I. 316	3.08	78.2	2.74	69.6	2-1/8"
2"	16VM16-E	2" - 11-1/2 NPTF	acero	3.10	78.7	3.56	90.4	2-1/2"
	16VM16-SS-E	2" - 11-1/2 NPTF	A.I. 316	3.10	78.7	3.56	90.4	2-1/2"

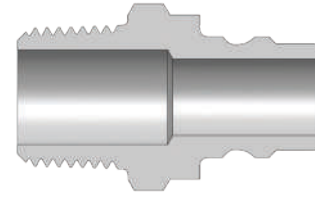
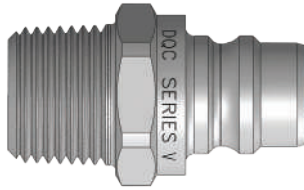

Serie-V Niple sin Válvula MIL-C-51234 (Roscas Macho)

Medida	Detalle							
	Detalle			Medida		DE Máximo		Hex pulg
	# Parte	Roscas	Material	pulg	mm	pulg	mm	
1/4"	V2M2-E	1/4" - 18 NPTF	acero	1.52	38.6	0.69	17.5	5/8"
	V2M2-B-E	1/4" - 18 NPTF	latón	1.52	38.6	0.69	17.5	5/8"
	V2M2-SS-E	1/4" - 18 NPTF	A.I. 316	1.52	38.6	0.69	17.5	5/8"
3/8"	V3M3-E	3/8" - 18 NPTF	acero	1.72	43.7	0.90	22.9	13-16"
	V3M3-B-E	3/8" - 18 NPTF	latón	1.72	43.7	0.90	22.9	13/16"
	V3M3-SS-E	3/8" - 18 NPTF	A.I. 316	1.72	43.7	0.90	22.9	13/16"
1/2"	V4M4-E	1/2" - 14 NPTF	acero	1.80	45.7	1.10	27.9	1"
	V4M4-B-E	1/2" - 14 NPTF	latón	1.80	45.7	1.10	27.9	1"
	V4M4-SS-E	1/2" - 14 NPTF	A.I. 316	1.80	45.7	1.10	27.9	1"
3/4"	V6M6-E	3/4" - 14 NPTF	acero	2.19	55.6	1.31	33.3	1-3/16"
	V6M6-B-E	3/4" - 14 NPTF	latón	2.19	55.6	1.31	33.3	1-3/16"
	V6M6-SS-E	3/4" - 14 NPTF	A.I. 316	2.19	55.6	1.31	33.3	1-3/16"
1"	V8M8-E	1" - 11-1/2 NPTF	acero	2.31	58.7	1.65	41.9	1-1/2"
	V8M8-B-E	1" - 11-1/2 NPTF	latón	2.31	58.7	1.65	41.9	1-1/2"
	V8M8-SS-E	1" - 11-1/2 NPTF	A.I. 316	2.31	58.7	1.65	41.9	1-1/2"
1-1/4"	V10M10-E	1-1/4" - 11-1/2 NPTF	acero	2.14	54.4	2.06	52.3	1-7/8"
	V10M10-SS-E	1-1/4" - 11-1/2 NPTF	A.I. 316	2.14	54.4	2.06	52.3	1-7/8"
1-1/2"	V12M12-E	1-1/2" - 11-1/2 NPTF	acero	2.34	59.4	2.33	59.2	2-1/8"
	V12M12-SS-E	1-1/2" - 11-1/2 NPTF	A.I. 316	2.34	59.4	2.33	59.2	2-1/8"
2"	V16M16-E	2" - 11-1/2 NPTF	acero	3.06	77.7	2.74	69.6	2-1/2"
	V16M16-SS-E	2" - 11-1/2 NPTF	A.I. 316	3.06	77.7	2.74	69.6	2-1/2"



Serie-V Tapas y Tapones Guarda Polvo

Medida	Detalle		
	Tapón Guarda Polvo	Tapa Guarda Polvo	Material
	1/4"	1HDP	V2DC
3/8"	3VDP-V3DC combinación tapa/tapón		nitrilo
1/2"	3KDP-K3DC combinación tapa/tapón		nitrilo
3/4"	6VDP-V6DC combinación tapa/tapón		nitrilo
1"	8VDP-V8DC combinación tapa/tapón		nitrilo



Medida	Serie-V Tapón Rígido para Cople		
	Detalle		
	# Parte	Cuerda	Cuerpo
1/4"	2VDP-A	cable de acero	aluminio
3/8"	3VDP-A	cable de acero	aluminio
1/2"	4VDP-A	cable de acero	aluminio
3/4"	6VDP-A	cable de acero	aluminio
1"	8VDP-A	cable de acero	aluminio
1-1/4"	10VDP-A	cable de acero	aluminio
1-1/2"	12VDP-A	cable de acero	aluminio
2"	16VDP-A	cable de acero	aluminio



Medida	Serie-V Tapa Rígida para Cople		
	Detalle		
	# Parte	Cuerda	Cuerpo
1/4"	V2DC-A	cable de acero	aluminio
3/8"	V3DC-A	cable de acero	aluminio
1/2"	V4DC-A	cable de acero	aluminio
3/4"	V6DC-A	cable de acero	aluminio
1"	V8DC-A	cable de acero	aluminio
1-1/4"	V10DC-A	cable de acero	aluminio
1-1/2"	V12DC-A	cable de acero	aluminio
2"	V16DC-A	cable de acero	aluminio

Medida	Serie-V Kit de Sellos para Acople MIL-C-51234			
	Detalle			Contenido de Kit de Sellos
	# Parte	Estilo de Cople	Material de Sello	
1/4"	2V-SKIT	Todos	Nitrilo	O-ring de Adaptador y Cuerpo y Refuerzo PTFE
	F-2V-SKIT	Todos	FKM	O-ring de Adaptador y Cuerpo y Refuerzo PTFE
	P-2V-SKIT	Todos	EPDM	O-ring de Adaptador y Cuerpo y Refuerzo PTFE
3/8"	3V-SKIT	Todos	Nitrilo	O-ring de Adaptador y Cuerpo y Refuerzo PTFE
	F-3V-SKIT	Todos	FKM	O-ring de Adaptador y Cuerpo y Refuerzo PTFE
	P-3V-SKIT	Todos	EPDM	O-ring de Adaptador y Cuerpo y Refuerzo PTFE
1/2"	4V-SKIT	Todos	Nitrilo	O-ring de Adaptador y Cuerpo y Refuerzo PTFE
	F-4V-SKIT	Todos	FKM	O-ring de Adaptador y Cuerpo y Refuerzo PTFE
	P-4V-SKIT	Todos	EPDM	O-ring de Adaptador y Cuerpo y Refuerzo PTFE
3/4"	6V-SKIT	Todos	Nitrilo	O-ring de Adaptador y Cuerpo y Refuerzo PTFE
	F-6V-SKIT	Todos	FKM	O-ring de Adaptador y Cuerpo y Refuerzo PTFE
	P-6V-SKIT	Todos	EPDM	O-ring de Adaptador y Cuerpo y Refuerzo PTFE
1"	8V-SKIT	Todos	Nitrilo	O-ring de Adaptador y Cuerpo y Refuerzo PTFE
	F-8V-SKIT	Todos	FKM	O-ring de Adaptador y Cuerpo y Refuerzo PTFE
	P-8V-SKIT	Todos	EPDM	O-ring de Adaptador y Cuerpo y Refuerzo PTFE
1-1/4"	10V-SKIT	Todos	Nitrilo	O-ring de Adaptador, Cuerpo y Válvula con Refuerzo PTFE
	F-10V-SKIT	Todos	FKM	O-ring de Adaptador, Cuerpo y Válvula con Refuerzo PTFE
	P-10V-SKIT	Todos	EPDM	O-ring de Adaptador, Cuerpo y Válvula con Refuerzo PTFE
1-1/2"	12V-SKIT	Todos	Nitrilo	O-ring de Adaptador, Cuerpo y Válvula con Refuerzo PTFE
	F-12V-SKIT	Todos	FKM	O-ring de Adaptador, Cuerpo y Válvula con Refuerzo PTFE
	P-12V-SKIT	Todos	EPDM	O-ring de Adaptador, Cuerpo y Válvula con Refuerzo PTFE
2"	16V-SKIT	Todos	Nitrilo	O-ring de Adaptador, Cuerpo y Válvula con Refuerzo PTFE
	F-16V-SKIT	Todos	FKM	O-ring de Adaptador, Cuerpo y Válvula con Refuerzo PTFE
	P-16V-SKIT	Todos	EPDM	O-ring de Adaptador, Cuerpo y Válvula con Refuerzo PTFE

Medida	Serie-V Kits de Reparación para Cople MIL-C-51234			
	Detalle			Contenido de Kits de Reparación (para un cople)
	# Parte	Material Cople	Material de Sello	
1/4"	2V-RKIT	acero	nitrilo	O-ring de válvula de acero y adaptador
	2V-BRKIT	latón	nitrilo	O-ring de válvula de latón y adaptador
	2V-SSRKIT	A.I. 316	nitrilo	O-ring de válvula de AI 316 y adaptador
3/8"	3V-RKIT	acero	nitrilo	O-ring de válvula de acero y adaptador
	3V-BRKIT	latón	nitrilo	O-ring de válvula de latón y adaptador
	3V-SSRKIT	A.I. 316	nitrilo	O-ring de válvula de AI 316 y adaptador
1/2"	4V-RKIT	acero	nitrilo	O-ring de válvula de acero y adaptador
	4V-BRKIT	latón	nitrilo	O-ring de válvula de latón y adaptador
	4V-SSRKIT	A.I. 316	nitrilo	O-ring de válvula de AI 316 y adaptador
3/4"	6V-RKIT	acero	nitrilo	O-ring de válvula de acero y adaptador
	6V-BRKIT	latón	nitrilo	O-ring de válvula de latón y adaptador
	6V-SSRKIT	A.I. 316	nitrilo	O-ring de válvula de AI 316 y adaptador
1"	8V-RKIT	acero	nitrilo	O-ring de válvula de acero y adaptador
	8V-BRKIT	latón	nitrilo	O-ring de válvula de latón y adaptador
	8V-SSRKIT	A.I. 316	nitrilo	O-ring de válvula de AI 316 y adaptador
1-1/4"	140030-10	acero	nitrilo	O-ring de válvula de acero y adaptador
	140032-10	A.I. 316	nitrilo	O-ring de válvula de AI 316 y adaptador
1-1/2"	140030-12	acero	nitrilo	O-ring de válvula de acero y adaptador
	140032-12	A.I. 316	nitrilo	O-ring de válvula de AI 316 y adaptador
2"	140030-16	acero	nitrilo	O-ring de válvula de acero y adaptador
	140032-16	A.I. 316	nitrilo	O-ring de válvula de AI 316 y adaptador

Medida	Serie-V Kits de Reparación para Niple MIL-C-51234			
	Detalle			Contenido de Kits de Reparación (para un niple)
	# Parte	Material Cople	Material de Sello	
1/4"	V2-RKIT	acero	nitrilo	O-ring de válvula de acero y adaptador
	V2-BRKIT	latón	nitrilo	O-ring de válvula de latón y adaptador
	V2-SSRKIT	A.I. 316	nitrilo	O-ring de válvula de AI 316 y adaptador
3/8"	V3-RKIT	acero	nitrilo	O-ring de válvula de acero y adaptador
	V3-BRKIT	latón	nitrilo	O-ring de válvula de latón y adaptador
	V3-SSRKIT	A.I. 316	nitrilo	O-ring de válvula de AI 316 y adaptador
1/2"	V4-RKIT	acero	nitrilo	O-ring de válvula de acero y adaptador
	V4-BRKIT	latón	nitrilo	O-ring de válvula de latón y adaptador
	V4-SSRKIT	A.I. 316	nitrilo	O-ring de válvula de AI 316 y adaptador
3/4"	V6-RKIT	acero	nitrilo	O-ring de válvula de acero y adaptador
	V6-BRKIT	latón	nitrilo	O-ring de válvula de latón y adaptador
	V6-SSRKIT	A.I. 316	nitrilo	O-ring de válvula de AI 316 y adaptador
1"	V8-RKIT	acero	nitrilo	O-ring de válvula de acero y adaptador
	V8-BRKIT	latón	nitrilo	O-ring de válvula de latón y adaptador
	V8-SSRKIT	A.I. 316	nitrilo	O-ring de válvula de AI 316 y adaptador
1-1/4"	140030-10	acero	nitrilo	O-ring de válvula de acero y adaptador
	140032-10	A.I. 316	nitrilo	O-ring de válvula de AI 316 y adaptador
1-1/2"	140030-12	acero	nitrilo	O-ring de válvula de acero y adaptador
	140032-12	A.I. 316	nitrilo	O-ring de válvula de AI 316 y adaptador
2"	140030-16	acero	nitrilo	O-ring de válvula de acero y adaptador
	140032-16	A.I. 316	nitrilo	O-ring de válvula de AI 316 y adaptador

Información de Intercambio

- Intercambio Europeo
- TEMA Serie 3800, 5000, 7500, 10000
- CEJN Serie 525

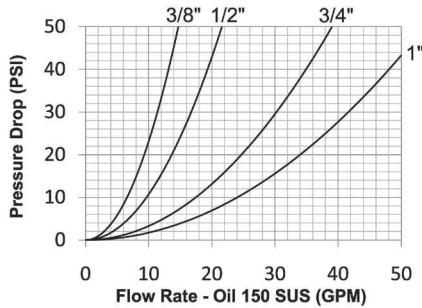

Materiales

- Los componentes son maquinados con barras sólidas de acero.
- Resortes de acero inoxidable, balines y anillo de retención de acero inoxidable
- Los componentes de acero son platinados con cromo trivalente y cumplen con la norma ROHS
- Las mangas de acople son endurecidas para resistir la deformación y maximizar la vida del servicio
- Los nipples de acero son endurecidos para brindar un desempeño de trabajo pesado y resistencia

Componentes del Sello

- Sellos de Nitrilo (Buna-N) estándar brindan un rango de temperatura de **-40°F a 250°F (-40°C a 121°C)**
- Los coples tienen un sistema de sellado O-ring (doble O-ring con anillo de PTFE)
- Los sellos de las válvulas poppet se crimpa para mantener la integridad durante condiciones de flujo excesivo y conexión presurizada

Tabla de Valores de Presión

Medida	Serie-TR Intercambio Europeo (Conectado)			
	Cople/Niple Acero			
	Trabajo Máximo		Reventón	
	PSI	Bar	PSI	Bar
3/8"	5,000	345	20,000	1,400
1/2"	4,000	275	16,500	1,100
3/4"	4,000	275	15,400	1,000
1"	3,200	220	12,800	900

Especificaciones Técnicas

Medida	Estándar Intercambio				Parámetros Funcionales				
	Ejército USA	Gobierno USA	Estántar Int	Estándar ANSI/NFPA	Cant Balines	Inclusión Aire	Pérdida Fluido	Vacío pulg HG	Flujo $\Delta P = 22$ PSI
3/8"	-	-	-	-	9	2.8cc	1.9cc	28	10 GPM
1/2"	-	-	-	-	9	3.9cc	3.1cc	28	15 GPM
3/4"	-	-	-	-	9	10.5cc	10.1cc	28	26 GPM
1"	-	-	-	-	9	14.7cc	14.2cc	28	36 GPM

Perfil Intercambio TR

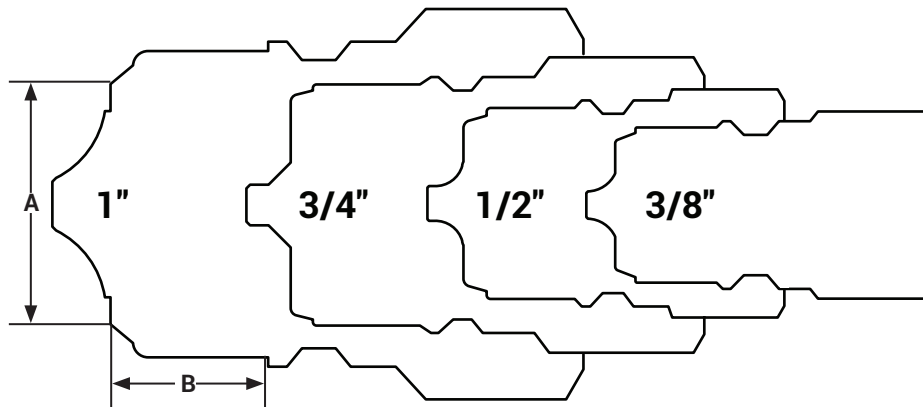

Tamaño	A	B
3/8"	0.78	0.53
1/2"	0.97	0.60
3/4"	1.29	0.75
1"	1.61	0.85

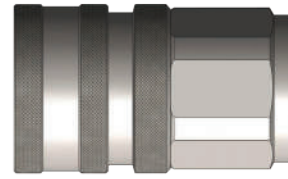
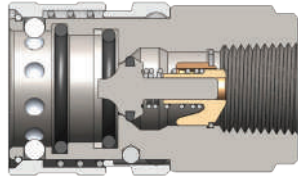

Medida	Serie-TR Cople Intercambio Europeo (Roscas Hembra)							
	Detalle			Medida		DE Máximo		Hex mm
	# Parte	Roscas	Material	pulg	mm	pulg	mm	
3/8"	3TRF3	3/8" - 18 NPTF	acero	2.52	64.0	1.38	35.0	30
	3TRBF3	3/8" - 19 BSPP	acero	2.52	64.0	1.38	35.0	30
1/2"	4TRF4	1/2" - 14 NPTF	acero	2.62	66.5	1.57	40.0	36
	4TRBF4	1/2" - 14 BSPP	acero	2.62	66.5	1.57	40.0	36
3/4"	6TRF6	3/4" - 14 NPTF	acero	3.35	85.0	2.05	52.0	41
	6TRBF6	3/4" - 14 BSPP	acero	3.35	85.0	2.05	52.0	41
1"	8TRF8	1" - 11-1/2 NPTF	acero	3.90	99.0	2.56	65.0	55
	8TRBF8	1" - 11 BSPP	acero	3.90	99.0	2.56	65.0	55

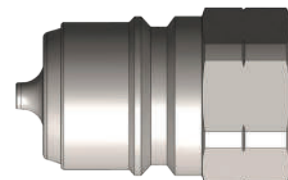
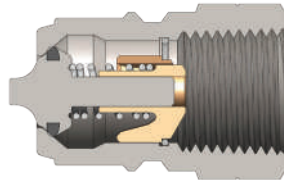

Medida	Serie-TR Niple Intercambio Europeo (Roscas Hembra)							
	Detalle			Medida		DE Máximo		Hex mm
	# Parte	Roscas	Material	pulg	mm	pulg	mm	
3/8"	TR3F3	3/8" - 18 NPTF	acero	1.59	40.5	1.00	25.4	22
	TR3BF3	3/8" - 19 BSPP	acero	1.59	40.5	1.00	25.4	22
1/2"	TR4F4	1/2" - 14 NPTF	acero	1.63	41.5	1.23	31.1	27
	TR4BF4	1/2" - 14 BSPP	acero	1.63	41.5	1.23	31.1	27
3/4"	TR6F6	3/4" - 14 NPTF	acero	2.20	56.0	1.63	41.5	36
	TR6BF6	3/4" - 14 BSPP	acero	2.20	56.0	1.63	41.5	36
1"	TR8F8	1" - 11-1/2 NPTF	acero	2.48	63.0	2.09	53.0	46
	TR8BF8	1" - 11 BSPP	acero	2.48	63.0	2.09	53.0	46

Medida	Serie-TR Kit de Sellos para Cople Intercambio Europeo			
	Detalle			Contenido de Kit de Sellos
	# Parte	Estilo de Cople	Material de Sello	
3/8"	3TR-SKIT	Todos	nitrilo	two O-rings and one PTFE back-up ring
1/2"	4TR-SKIT	Todos	nitrilo	two O-rings and one PTFE back-up ring
3/4"	6TR-SKIT	Todos	nitrilo	two O-rings and one PTFE back-up ring
1"	8TR-SKIT	Todos	nitrilo	two O-rings and one PTFE back-up ring

Please contact Dixon for dust caps and dust plugs.

Información de Intercambio

- Intercambio con ISO16028
- Parker Serie-FEM, Snap-Tite Serie-74, Hansen FF, Eaton/ Aeroquip FD89, Stucchi FIRG/Serie A, Faster FFH/FFN/FFI/2FFN/2FFI, Safeway Serie-FF49

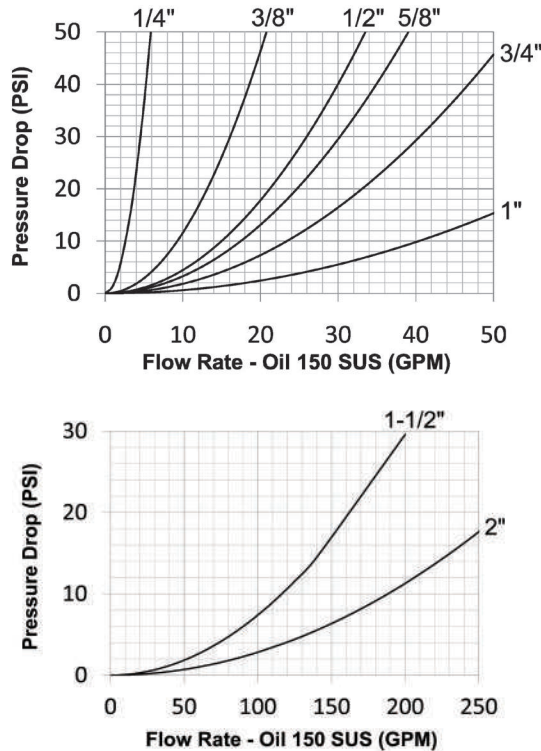

Materiales

- Los componentes son maquinados con barras sólidas de acero o acero inoxidable 316.
- Balines, anillos de retención, y resortes de acero inoxidable que extienden la vida del servicio
- Los componentes de acero son platinados con cromo trivalente y cumplen con la norma ROHS
- Las mangas de acople son endurecidas para resistir la deformación y maximizar la vida del servicio
- Los nipples de acero son endurecidos para brindar un desempeño de trabajo pesado y resistencia

Componentes del Sello

- Nipples 1/4", 3/8", 1/2", 3/4", y 1" tienen sellos de válvula de poliuretano, con un rango de temperatura de -65°F a 212°F (-54°C a 100°C)
- Nipples de 5/8" y 2" tienen sellos de válvula PTFE, con un rango de temperatura de -40°F a 250°F (-40°C a 121°C)
- Los coples tienen un O-ring de poliuretano con un rango de temperatura de -65°F a 212°F (-54°C a 100°C)
- Los sellos del cople y nipple auxiliares son de nitrilo (buna-N), con rango de temperatura de -40°F a 250°F (-40°C a 121°C)
- El anillo anti-extrusión PTFE o TPC-ET protege el sello de la válvula del cople del impulso dinámico por presión.

Serie-HT Correct Connect®

- Bandas de color azul estándar, otros colores se venden por separado.
- Contacta a Dixon para colores adicionales
- No requiere herramientas especiales
- Bandas de color de poliuretano

Tabla de Valores de Presión

Me- dida	Serie-HT ISO16028 Cara Plana															
	Cople/Niple Acero Conectado				Cople/Niple A.I. 316 Conectado				Acero Coupler Sin Conectar				Acero Plug Sin Conectar			
	Trabajo Max.		Reventón		Trabajo Max.		Reventón		Trabajo Max.		Reventón		Trabajo Max.		Reventón	
	PSI	Bar	PSI	Bar	PSI	Bar	PSI	Bar	PSI	Bar	PSI	Bar	PSI	Bar	PSI	Bar
1/4"	5,000	345	20,000	1,379	-	-	-	-	5,000	345	20,000	1,379	5,000	345	20,000	1,379
3/8"	5,000	345	20,000	1,379	3,500	241	17,500	1,207	5,000	345	20,000	1,379	5,000	345	20,000	1,379
1/2"	5,000	345	20,000	1,379	3,400	234	17,000	1,172	5,000	345	20,000	1,379	5,000	345	20,000	1,379
5/8"	5,000	345	20,000	1,379	2,920	201	14,600	1,007	5,000	345	20,000	1,379	5,000	345	20,000	1,379
3/4"	5,000	345	20,000	1,379	2,920	201	14,600	1,007	5,000	345	20,000	1,379	5,000	345	20,000	1,379
1"	5,000	345	20,000	1,379	2,920	201	14,600	1,007	5,000	345	20,000	1,379	5,000	345	20,000	1,379
1-1/2"	3,000	207	12,000	828	-	-	-	-	3,000	207	12,000	828	3,000	207	12,000	828
2"	3,000	207	12,000	828	-	-	-	-	3,000	207	12,000	828	3,000	207	12,000	828

Especificaciones Técnicas

Medida	Estándar Intercambio				Parámetros Funcionales					
	Ejército USA	Gobierno USA	Estántar Int	Estándar ANSI/NFPA	Cant Balines	Inclusión Aire	Pérdida Fluido	Vacío pulg HG	Flujo ΔP = 15 PSI	
1/4"	-	-	ISO16028	-	12	n/a	0.010cc	N/R	3.2 GPM	
3/8"	-	-	ISO16028	T3.20.15	12	n/a	0.010cc	N/R	11.0 GPM	
1/2"	-	-	ISO16028	-	12	n/a	0.010cc	N/R	18.0 GPM	
5/8"	-	-	ISO16028	-	12	n/a	0.020cc	N/R	21.0 GPM	
3/4"	-	-	ISO16028	-	12	n/a	0.030cc	N/R	28.0 GPM	
1"	-	-	ISO16028	-	12	n/a	0.030cc	N/R	50.0 GPM	
1-1/2"	-	-	-	-	18	n/a	0.050cc	N/R	140.0 GPM	
2"	-	-	-	-	20	n/a	0.070cc	N/R	225.0 GPM	



de Parte Bandas de Colores

Tamaño	Description	Azul # Parte	Naranja # Parte	Verde # Parte	Amarillo # Parte	Rojo # Parte
1/4"	banda cople	2HTBAND-B	2HTBAND-O	2HTBAND-G	2HTBAND-Y	2HTBAND-R
1/4"	banda niple	HT2BAND-B	HT2BAND-O	HT2BAND-G	HT2BAND-Y	HT2BAND-R
3/8"	banda cople	3HTBAND-B	3HTBAND-O	3HTBAND-G	3HTBAND-Y	3HTBAND-R
3/8"	banda niple	HT3BAND-B	HT3BAND-O	HT3BAND-G	HT3BAND-Y	HT3BAND-R
1/2"	banda cople	4HTBAND-B	4HTBAND-O	4HTBAND-G	4HTBAND-Y	4HTBAND-R
1/2"	banda niple	HT4BAND-B	HT4BAND-O	HT4BAND-G	HT4BAND-Y	HT4BAND-R
5/8"	banda cople	5HTBAND-B	5HTBAND-O	5HTBAND-G	5HTBAND-Y	5HTBAND-R
5/8"	banda niple	HT5BAND-B	HT5BAND-O	HT5BAND-G	HT5BAND-Y	HT5BAND-R
3/4"	banda cople	6HTBAND-B	6HTBAND-O	6HTBAND-G	6HTBAND-Y	6HTBAND-R
3/4"	banda niple	HT6BAND-B	HT6BAND-O	HT6BAND-G	HT6BAND-Y	HT6BAND-R
1"	banda cople	8HTBAND-B	8HTBAND-O	8HTBAND-G	8HTBAND-Y	8HTBAND-R
1"	banda niple	HT8BAND-B	HT8BAND-O	HT8BAND-G	HT8BAND-Y	HT8BAND-R

Opciones Disponibles

Medida	Opciones de Sellado Estándar						Opcion'es de Sello Kalrez®			Tratamiento
	FKM	EPDM	FDA FKM	Mil-Nitrilo	Nitrilo Combustible	Silicón	4079	6375	7075	Oxy-Clean
1/4"	F-	P-	D-	M-	JF-	S-	K4-	K6-	K7-	-C1
3/8"	F-	P-	D-	M-	JF-	S-	K4-	K6-	K7-	-C1
1/2"	F-	P-	D-	M-	JF-	S-	K4-	K6-	K7-	-C1
5/8"	F-	P-	D-	M-	JF-	S-	K4-	K6-	K7-	-C1
3/4"	F-	P-	D-	M-	JF-	S-	K4-	K6-	K7-	-C1
1"	F-	P-	D-	M-	JF-	S-	K4-	K6-	K7-	-C1
1-1/2"	F-	P-	D-	M-	JF-	S-	K4-	K6-	K7-	-C1
2"	F-	P-	D-	M-	JF-	S-	K4-	K6-	K7-	-C1

Perfil Serie-HT

Tamaño	A	B
1/4"	0.64	0.22
3/8"	0.78	0.19
1/2"	0.97	0.39
5/8"	1.06	0.39
3/4"	1.18	0.45
1"	1.42	0.43

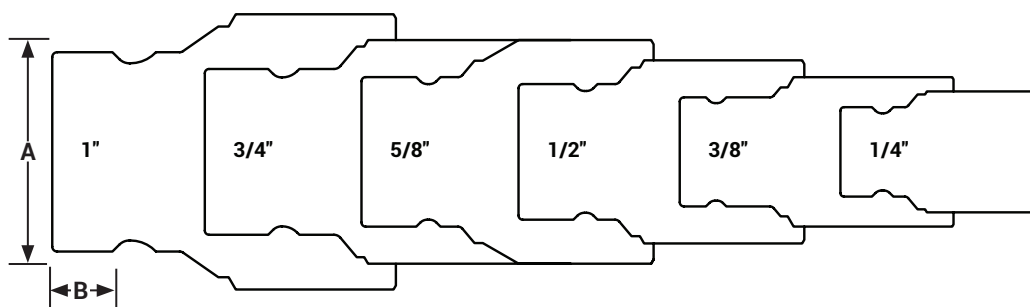

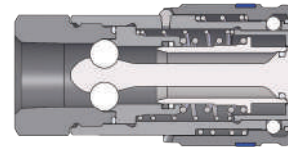

Medida	Serie-HT Cople Intercambio ISO16028 Cara Plana (Roscas Hembra)							
	Detalle			Medida		DE Máximo		Hex pulg
	# Parte	Roscas	Material	pulg	mm	pulg	mm	
1/4"	2HTF2	1/4" - 18 NPTF	acero	1.98	50.3	1.11	28.3	7/8"
	2HTBF2	1/4" - 19 BSPP	acero	1.98	50.3	1.11	28.3	7/8"
	2HTOF3	9/16" - 18 ORB	acero	1.98	50.3	1.11	28.3	7/8"
3/8"	3HTF3	3/8" - 18 NPTF	acero	2.50	63.5	1.24	31.5	1"
	3HTF3-SS	3/8" - 18 NPTF	A.I. 316	2.50	63.5	1.24	31.5	1"
	3HTBF3	3/8" - 19 BSPP	acero	2.50	63.5	1.24	31.5	1"
	3HTBF3-SS	3/8" - 19 BSPP	A.I. 316	2.50	63.5	1.24	31.5	1"
	3HTOF3	9/16" - 18 ORB	acero	2.50	63.5	1.24	31.5	1"
	3HTF4	1/2" - 14 NPTF	acero	2.72	69.1	1.24	31.5	1-1/8"
	3HTF4-SS	1/2" - 14 NPTF	A.I. 316	2.72	69.1	1.24	31.5	1-1/8"
	3HTBF4	1/2" - 14 BSPP	acero	2.72	69.1	1.24	31.5	1-1/8"
	3HTBF4-SS	1/2" - 14 BSPP	A.I. 316	2.72	69.1	1.24	31.5	1-1/8"
1/2"	3HTOF4	3/4" - 16 ORB	acero	2.72	69.1	1.24	31.5	1-1/8"
	4HTF4	1/2" - 14 NPTF	acero	3.02	76.7	1.54	39.1	1-3/16"
	4HTF4-SS	1/2" - 14 NPTF	A.I. 316	3.02	76.7	1.54	39.1	1-3/16"
	4HTBF4	1/2" - 14 BSPP	acero	3.02	76.7	1.54	39.1	1-3/16"
	4HTBF4-SS	1/2" - 14 BSPP	A.I. 316	3.02	76.7	1.54	39.1	1-3/16"
	4HTOF4	3/4" - 16 ORB	acero	3.02	76.7	1.54	39.1	1-3/16"
	4HTOF5	7/8" - 14 ORB	acero	3.12	79.2	1.54	39.1	1-5/16"
	4HTF6	3/4" - 14 NPTF	acero	3.22	81.8	1.54	39.1	1-5/16"
	4HTF6-SS	3/4" - 14 NPTF	A.I. 316	3.22	81.8	1.54	39.1	1-5/16"
	4HTBF6	3/4" - 14 BSPP	acero	3.22	81.8	1.54	39.1	1-5/16"
	4HTBF6-SS	3/4" - 14 BSPP	A.I. 316	3.22	81.8	1.54	39.1	1-5/16"
	4HTOF6	1-1/16" - 12 ORB	acero	3.42	86.9	1.54	39.1	1-5/16"
5/8"	5HTOF5	7/8" - 14 ORB	acero	3.32	84.3	1.67	42.4	1-1/2"
	5HTF6	3/4" - 14 NPTF	acero	3.32	84.3	1.67	42.4	1-1/2"
	5HTF6-SS	3/4" - 14 NPTF	A.I. 316	3.32	84.3	1.67	42.4	1-1/2"
	5HTBF6	3/4" - 14 BSPP	acero	3.32	84.3	1.67	42.4	1-1/2"
	5HTBF6-SS	3/4" - 14 BSPP	A.I. 316	3.32	84.3	1.67	42.4	1-1/2"
	5HTOF6	1-1/16" - 12 ORB	acero	3.32	84.3	1.67	42.4	1-1/2"
3/4"	6HTOF5	7/8" - 14 ORB	acero	3.70	94.0	1.85	47.0	1-1/2"
	6HTF6	3/4" - 14 NPTF	acero	3.70	94.0	1.85	47.0	1-1/2"
	6HTF6-SS	3/4" - 14 NPTF	A.I. 316	3.70	94.0	1.85	47.0	1-1/2"
	6HTBF6	3/4" - 14 BSPP	acero	3.70	94.0	1.85	47.0	1-1/2"
	6HTBF6-SS	3/4" - 14 BSPP	A.I. 316	3.70	94.0	1.85	47.0	1-1/2"
	6HTOF6	1-1/16" - 12 ORB	acero	3.70	94.0	1.85	47.0	1-1/2"
	6HTF8	1" - 11-1/2 NPTF	acero	3.82	97.0	1.92	48.8	1-3/4"
	6HTF8-SS	1" - 11-1/2 NPTF	A.I. 316	3.82	97.0	1.92	48.8	1-3/4"
	6HTBF8	1" - 11 BSPP	acero	3.82	97.0	1.92	48.8	1-3/4"
	6HTBF8-SS	1" - 11 BSPP	A.I. 316	3.82	97.0	1.92	48.8	1-3/4"
1"	6HTOF8	1-5/16" - 12 ORB	acero	3.82	97.0	1.92	48.8	1-3/4"
	8HTF8	1" - 11-1/2 NPTF	acero	4.24	107.7	2.29	58.2	1-3/4"
	8HTF8-SS	1" - 11-1/2 NPTF	A.I. 316	4.24	107.7	2.29	58.2	1-3/4"
	8HTBF8	1" - 11 BSPP	acero	4.24	107.7	2.29	58.2	1-3/4"
	8HTBF8-SS	1" - 11 BSPP	A.I. 316	4.24	107.7	2.29	58.2	1-3/4"
	8HTOF8	1-5/16" - 12 ORB	acero	4.24	107.7	2.29	58.2	1-3/4"
	8HTF10	1-1/4" - 11-1/2 NPTF	acero	4.34	110.2	2.29	58.2	2"
	8HTF10-SS	1-1/4" - 11-1/2 NPTF	A.I. 316	4.34	110.2	2.29	58.2	2"
	8HTBF10	1-1/4" - 11 BSPP	acero	4.29	109.0	2.29	58.2	2"
	8HTBF10-SS	1-1/4" - 11 BSPP	A.I. 316	4.29	109.0	2.29	58.2	2"
	8HTOF10	1-5/8" - 12 ORB	acero	4.24	107.7	2.29	58.2	2"

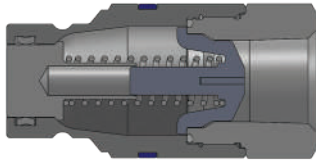

Medida	Serie-HT Niple Intercambio ISO16028 Cara Plana (Roscas Hembra)							
	Detalle			Medida		DE Máximo		Hex pulg
	# Parte	Roscas	Material	pulg	mm	pulg	mm	
1/4"	HT2F2	1/4" - 18 NPTF	acero	1.89	48.0	0.97	24.6	7/8"
	HT2BF2	1/4" - 19 BSPP	acero	1.89	48.0	0.97	24.6	7/8"
	HT2OF3	9/16" - 18 ORB	acero	1.89	48.0	0.97	24.6	7/8"
3/8"	HT3F3	3/8" - 18 NPTF	acero	2.48	63.0	1.10	27.9	1"
	HT3F3-SS	3/8" - 18 NPTF	A.I. 316	2.48	63.0	1.10	27.9	1"
	HT3BF3	3/8" - 19 BSPP	acero	2.48	63.0	1.10	27.9	1"
	HT3BF3-SS	3/8" - 19 BSPP	A.I. 316	2.48	63.0	1.10	27.9	1"
	HT3OF3	9/16" - 18 ORB	acero	2.48	63.0	1.10	27.9	1"
	HT3F4	1/2" - 14 NPTF	acero	2.70	68.6	1.24	31.5	1-1/8"
	HT3F4-SS	1/2" - 14 NPTF	A.I. 316	2.70	68.6	1.24	31.5	1-1/8"
	HT3BF4	1/2" - 14 BSPP	acero	2.70	68.6	1.24	31.5	1-1/8"
	HT3BF4-SS	1/2" - 14 BSPP	A.I. 316	2.70	68.6	1.24	31.5	1-1/8"
1/2"	HT3OF4	3/4" - 16 ORB	acero	2.70	68.6	1.24	31.5	1-1/8"
	HT4F4	1/2" - 14 NPTF	acero	2.63	66.8	1.31	33.3	1-3/16"
	HT4F4-SS	1/2" - 14 NPTF	A.I. 316	2.63	66.8	1.31	33.3	1-3/16"
	HT4BF4	1/2" - 14 BSPP	acero	2.63	66.8	1.31	33.3	1-3/16"
	HT4BF4-SS	1/2" - 14 BSPP	A.I. 316	2.63	66.8	1.31	33.3	1-3/16"
	HT4OF4	3/4" - 16 ORB	acero	2.63	66.8	1.31	33.3	1-3/16"
	HT4OF5	7/8" - 14 ORB	acero	2.63	69.3	1.31	33.3	1-5/16"
	HT4F6	3/4" - 14 NPTF	acero	2.73	71.9	1.44	36.6	1-5/16"
	HT4F6-SS	3/4" - 14 NPTF	A.I. 316	2.83	71.9	1.44	36.6	1-5/16"
	HT4BF6	3/4" - 14 BSPP	acero	2.83	71.9	1.44	36.6	1-5/16"
5/8"	HT4BF6-SS	3/4" - 14 BSPP	A.I. 316	2.83	71.9	1.44	36.6	1-5/16"
	HT4OF6	1-1/16" - 12 ORB	acero	3.03	77.0	1.44	36.6	1-5/16"
	HT5OF5	7/8" - 14 ORB	acero	2.88	73.2	1.65	41.9	1-1/2"
	HT5F6	3/4" - 14 NPTF	acero	2.88	73.2	1.65	41.9	1-1/2"
	HT5F6-SS	3/4" - 14 NPTF	A.I. 316	2.88	73.2	1.65	41.9	1-1/2"
	HT5BF6	3/4" - 14 BSPP	acero	2.88	73.2	1.65	41.9	1-1/2"
	HT5BF6-SS	3/4" - 14 BSPP	A.I. 316	2.88	73.2	1.65	41.9	1-1/2"
	HT5OF6	1-1/16" - 12 ORB	acero	2.88	73.2	1.65	41.9	1-1/2"
	HT6OF5	7/8" - 14 ORB	acero	3.42	86.9	1.65	41.9	1-1/2"
	HT6F6	3/4" - 14 NPTF	acero	3.42	86.9	1.65	41.9	1-1/2"
3/4"	HT6F6-SS	3/4" - 14 NPTF	A.I. 316	3.42	86.9	1.65	41.9	1-1/2"
	HT6BF6	3/4" - 14 BSPP	acero	3.42	86.9	1.65	41.9	1-1/2"
	HT6BF6-SS	3/4" - 14 BSPP	A.I. 316	3.42	86.9	1.65	41.9	1-1/2"
	HT6OF6	1-1/16" - 12 ORB	acero	3.42	86.9	1.65	41.9	1-1/2"
	HT6F8	1" - 11-1/2 NPTF	acero	3.54	89.9	1.92	48.8	1-3/4"
	HT6F8-SS	1" - 11-1/2 NPTF	A.I. 316	3.54	89.9	1.92	48.8	1-3/4"
	HT6BF8	1" - 11 BSPP	acero	3.54	89.9	1.92	48.8	1-3/4"
	HT6BF8-SS	1" - 11 BSPP	A.I. 316	3.54	89.9	1.92	48.8	1-3/4"
	HT6OF8	1-5/16" - 12 ORB	acero	3.54	89.9	1.92	48.8	1-3/4"
	HT8F8	1" - 11-1/2 NPTF	acero	3.50	88.9	1.96	49.8	1-3/4"
1"	HT8F8-SS	1" - 11-1/2 NPTF	A.I. 316	3.50	88.9	1.96	49.8	1-3/4"
	HT8BF8	1" - 11 BSPP	acero	3.50	88.9	1.96	49.8	1-3/4"
	HT8BF8-SS	1" - 11 BSPP	A.I. 316	3.50	88.9	1.96	49.8	1-3/4"
	HT8OF8	1-5/16" - 12 ORB	acero	3.50	88.9	1.96	49.8	1-3/4"
	HT8F10	1-1/4" - 11-1/2 NPTF	acero	3.61	91.7	2.19	55.6	2"
	HT8F10-SS	1-1/4" - 11-1/2 NPTF	A.I. 316	3.61	91.7	2.19	55.6	2"
	HT8BF10	1-1/4" - 11 BSPP	acero	3.55	90.2	2.19	55.6	2"
	HT8BF10-SS	1-1/4" - 11 BSPP	A.I. 316	3.55	90.2	2.19	55.6	2"
	HT8OF10	1-5/8" - 12 ORB	acero	3.51	89.2	2.19	55.6	2"

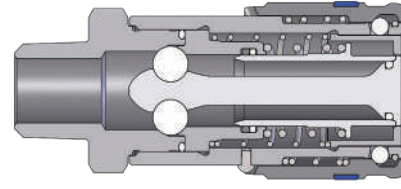

Serie-HT Cople Intercambio ISO16028 Cara Plana (Roscas Macho)

Medida	Detalle			Medida		DE Máximo		Hex pulg
	# Parte	Roscas	Material	pulg	mm	pulg	mm	
3/8"	3HTM3	3/8" - 18 NPTF	acero	2.88	73.2	1.24	31.5	1-1/8"
	3HTM4	1/2" - 14 NPTF	acero	2.97	75.4	1.24	31.5	1-1/8"
1/2"	4HTM4	1/2" - 14 NPTF	acero	3.42	86.9	1.54	39.1	1-5/16"

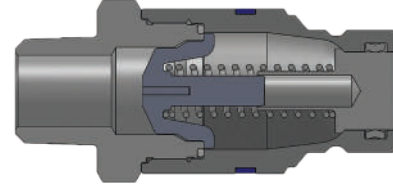
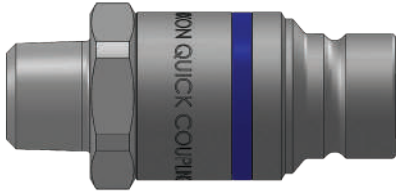

Serie-HT Niple Intercambio ISO16028 Cara Plana (Roscas Macho)

Medida	Detalle			Medida		DE Máximo		Hex pulg
	# Parte	Roscas	Material	pulg	mm	pulg	mm	
3/8"	HT3M3	3/8" - 18 NPTF	acero	2.87	72.9	1.24	31.5	1-1/8"
	HT3M4	1/2" - 14 NPTF	acero	2.96	75.2	1.24	31.5	1-1/8"
1/2"	HT4M4	1/2" - 14 NPTF	acero	3.03	77.0	1.44	36.6	1-5/16"

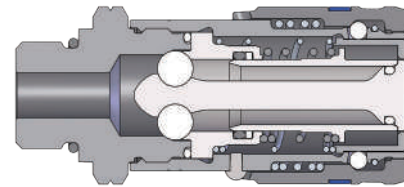
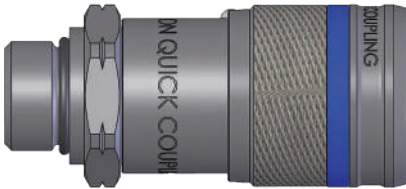

Serie-HT Cople Intercambio ISO16028 Cara Plana (Roscas Macho ORB)

Medida	Detalle			Medida		DE Máximo		Hex pulg
	# Parte	Roscas	Material	pulg	mm	pulg	mm	
3/8"	3HTOM3	9/16" - 18 ORB	acero	2.75	69.9	1.24	31.5	1-1/8"
	3HTOM4	3/4" - 16 ORB	acero	2.75	69.9	1.24	31.5	1-1/8"

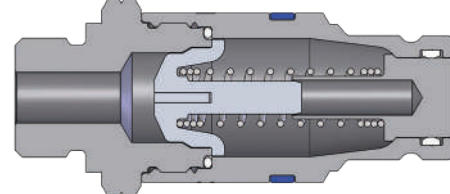

HT-Series ISO16028 Flushface Interchange Plug (Male ORB Roscas)

Medida	Detalle			Medida		DE Máximo		Hex pulg
	# Parte	Roscas	Material	pulg	mm	pulg	mm	
3/8"	HT30M3	9/16" - 18 ORB	acero	2.73	69.3	1.17	29.7	1-1/8"
	HT30M4	3/4" - 16 ORB	acero	2.73	69.3	1.17	29.7	1-1/8"

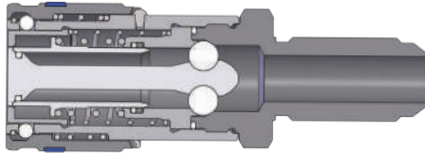

Medida	Serie-HT Cople Intercambio ISO16028 Cara Plana (Roscas Macho Pasamuros)							
	Detalle			Medida		DE Máximo		Hex pulg
	# Parte	Roscas	Material	pulg	mm	pulg	mm	
1/2"	4HTRB4	13/16"-16 ORFS BH	acero	4.19	106.4	1.54	39.1	1-5/16"
	4HTJB5	7/8" - 14 JIC BH	acero	4.38	111.3	1.54	39.1	1-5/16"
	4HTRB5	1" - 14 ORFS BH	acero	4.37	111.0	1.54	39.1	1-5/16"
	4HTRB6	1-3/16"-12 ORFS BH	acero	4.40	111.7	1.54	39.1	1-5/16"
	4HTJB6	1-1/16" - 12 JIC BH	acero	4.55	115.6	1.54	39.1	1-5/16"

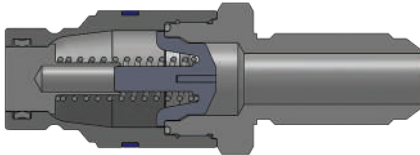

Medida	Serie-HT Niple Intercambio ISO16028 Cara Plana (Roscas Macho Pasamuros)							
	Detalle			Medida		DE Máximo		Hex pulg
	# Parte	Roscas	Material	pulg	mm	pulg	mm	
1/2"	HT4RB4	13/16"-16 ORFS BH	acero	3.83	97.2	1.44	36.5	1-5/16"
	HT4JB5	7/8" - 14 JIC BH	acero	3.99	101.3	1.44	36.6	1-5/16"
	HT4RB5	1" - 14 ORFS BH	acero	3.98	101.1	1.44	36.6	1-5/16"
	HT4RB6	1-3/16"-12 ORFS BH	acero	4.00	101.6	1.44	36.5	1-5/16"
	HT4JB6	1-1/16" - 12 JIC BH	acero	4.16	115.6	1.44	36.6	1-5/16"

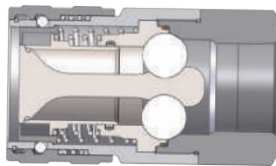

Medida	Serie-HT Cople Intercambio ISO16028 Cara Plana (Roscas Hembra)							
	Detalle			Medida		DE Máximo		Hex pulg
	# Parte	Roscas	Material	pulg	mm	pulg	mm	
1-1/2"	12HTF12	1-1/2" - 11-1/2 NPT	acero	5.23	132.7	3.37	85.5	2-1/2"
	12HTBF12	1-1/2 - 11 BSPP	acero	5.23	132.7	3.37	85.5	2-1/2"
	12HTOF12	1-7/8" - 12 ORB	acero	5.23	132.7	3.37	85.5	2-1/2"
2"	16HTF16	2" - 11-1/2 NPTF	acero	6.75	171.3	3.95	100.3	3-1/2"
	16HTBF16	2" - 11 BSPP	acero	6.75	171.3	3.95	100.3	3-1/2"
	16HTOF16	2-1/2" - 12 ORB	acero	6.75	171.3	3.95	100.3	3-1/2"

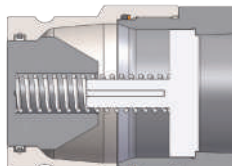

Medida	Serie-HT Niple Intercambio ISO16028 Cara Plana (Roscas Hembra)							
	Detalle			Medida		DE Máximo		Hex pulg
	# Parte	Roscas	Material	pulg	mm	pulg	mm	
1-1/2"	HT12F12	1-1/2" - 11-1/2 NPT	acero	4.25	107.9	2.75	69.8	2-1/2"
	HT12BF12	1-1/2 - 11 BSPP	acero	4.25	107.9	2.75	69.8	2-1/2"
	HT12OF12	1-7/8" - 12 ORB	acero	4.25	107.9	2.75	69.8	2-1/2"
2"	HT16F16	2" - 11-1/2 NPTF	acero	4.62	117.3	3.29	83.5	3"
	HT16BF16	2" - 11 BSPP	acero	4.62	117.3	3.29	83.5	3"
	HT16OF16	2-1/2" - 12 ORB	acero	4.62	117.3	3.29	83.5	3"

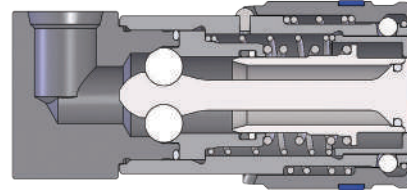

Serie-HT Cople Hembra Roscado Cara Plana 90°

Medida	Detalle			Medida		DE Máximo		Hex pulg
	# Parte	Roscas	Material	pulg	mm	pulg	mm	
1/2"	4HT90F3	9/16"-18 ORB	acero	3.30	83.82	1.53	38.86	1-3/8"
	4HT90F4	3/4"-16 ORB	acero	3.42	86.87	1.68	42.55	1-1/2"

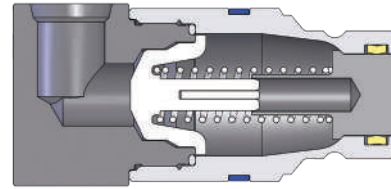

Serie-HT Niple Hembra Roscado Cara Plana 90°

Medida	Detalle			Medida		DE Máximo		Hex pulg
	# Parte	Roscas	Material	pulg	mm	pulg	mm	
1/2"	HT490F3	9/16"-18 ORB	acero	2.90	73.66	1.53	38.86	1-3/8"
	HT490F4	3/4"-16 ORB	acero	3.03	76.96	1.68	42.67	1-1/2"



Serie-HT Tapa Guarda Polvo ISO16028 Cara Plana

Medida	Detalle		Cuerpo
	# Parte		
1/4"	2HTDP		nitrilo
3/8"	3HTDP		nitrilo
1/2"	4HTDP		nitrilo
5/8"	5HTDP		nitrilo
3/4"	6HTDP		nitrilo
1"	8HTDP		nitrilo



Serie-HT Tapa Guarda Polvo ISO16028 Flushface 'Cara Plana'

Medida	Detalle		Cuerpo
	# Parte		
1/4"	HT2DC		nitrilo
3/8"	HT3DC		nitrilo
1/2"	HT4DC		nitrilo
5/8"	HT5DC		nitrilo
3/4"	HT6DC		nitrilo
1"	HT8DC		nitrilo

Medida	Serie-HT Kit de Sellos para Cople Intercambio ISO16028 Cara Plana			
	Detalle			Contenido de Kit de Sellos
	# Parte	Estilo de Cople	Material de Sello	
1/4"	2HT-SKIT	todos	nitrilo	Glándula O-ring de vástago/adaptador, glándula B.U.
3/8"	3HT-SKIT	todos	nitrilo	Glándula O-ring de vástago/adaptador, glándula B.U.
1/2"	4HT-SKIT	todos	nitrilo	Glándula O-ring de vástago/adaptador, glándula B.U.
5/8"	5HT-SKIT	todos	nitrilo	Glándula O-ring de vástago/adaptador, glándula B.U.
3/4"	6HT-SKIT	todos	nitrilo	Glándula O-ring de vástago/adaptador, glándula B.U.
1"	8HT-SKIT	todos	nitrilo	Glándula O-ring de vástago/adaptador, glándula B.U.

Medida	Serie-HT Kit de Sellos para Niple Intercambio ISO16028 Cara Plana			
	Detalle			Contenido de Kit de Sellos
	# Parte	Estilo de Niple	Material de Sello	
1/4"	HT2-SKIT-V2	todos	nitrilo	Sello de válvula principal y O-ring de adaptador
3/8"	HT3-SKIT-V2	todos	nitrilo	Sello de válvula principal y O-ring de adaptador
1/2"	HT4-SKIT-V2	todos	nitrilo	Sello de válvula principal y O-ring de adaptador
5/8"	HT5-SKIT-V2	todos	nitrilo	Sello de válvula principal y O-ring de adaptador
3/4"	HT6-SKIT-V2	todos	nitrilo	Sello de válvula principal y O-ring de adaptador
1"	HT8-SKIT-V2	todos	nitrilo	Sello de válvula principal y O-ring de adaptador

Información de Intercambio

- Parker FEC-Series, Stucchi APM-Series, Faster 3FFH-Series

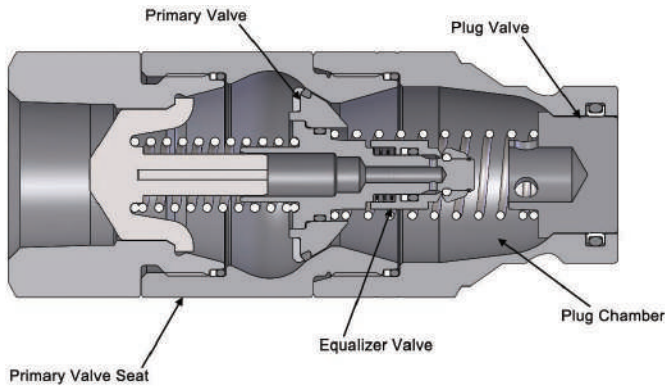
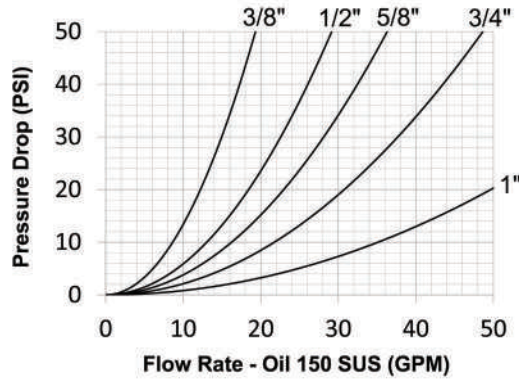

Materiales

- Los componentes son maquinados con barras sólidas de acero
- Los componentes de acero son platinados con zinc niquelado que cumple con la norma ROHS
- Anillos de retención y resortes de acero inoxidable maximizan la resistencia a la corrosión y extienden la vida del servicio.
- Los nipples son endurecidos para para brindar resistencia al efecto brinell durante el impulso del servicio.

Componentes del Sello

- Nipples de 3/8", 1/2", 3/4" y 1" tienen válvula con sellos de poliuretano, con un rango de temperatura de -65°F a 212°F (-54°C a 100°C)
- Los nipples de 5/8" tienen sello de válvula PTFE energizados con nitrilo con un rango de temperatura de -40°F a 250°F (-40°C a 121°C)
- Los sellos auxiliares del nipple son de nitrilo (buna-N), con un rango de temperatura de -40°F a 250°F (-40°C a 121°C)
- Los anillos de reemplazo en todas las medidas es de PTFE

Terminología del Componente

- Fuerza de conexión no-lineal en muchas presiones
- Sin restricciones máximas de presión para conectar
- El cabezal de presión o purga de la válvula tiene un mínimo efecto en la fuerza de conexión
- Menos susceptible a la contaminación del sistema
- El diseño escalado se desempeña de manera similar en muchas medidas
- Conexión suave

Tabla de Valores de Presión

Medida	Serie-HTE Niple ISO16028 "Conecte a Presión" Cara Plana											
	Cople Acero HT/ Niple HTE con Cople				Niple HTE Sin Cople				Inclusión de Aire	Pérdida de Fluido	Vacío pulg HG	Flujo ΔP = 14.5 PSI
	Trabajo Max.		Reventón		Trabajo Max.		Reventón					
	PSI	Bar	PSI	Bar	PSI	Bar	PSI	Bar				
3/8"	5,000	345	20,000	1,380	5,000	345	20,000	1,380	n/a	0.010cc	N/R	9.5 GPM
1/2"	5,000	345	20,000	1,380	5,000	345	20,000	1,380	n/a	0.010cc	N/R	15.0 GPM
5/8"	5,000	345	20,000	1,380	5,000	345	20,000	1,380	n/a	0.020cc	N/R	18.0 GPM
3/4"	5,000	345	20,000	1,380	5,000	345	20,000	1,380	n/a	0.030cc	N/R	24.0 GPM
1"	5,000	345	20,000	1,380	5,000	345	20,000	1,380	n/a	0.030cc	N/R	44.0 GPM

El Proceso de Conexión

Paso 1: Desconectado

El niple tiene presión residual atrapada detras de la válvula principal, mientras que el cople no tiene presión atrapada.

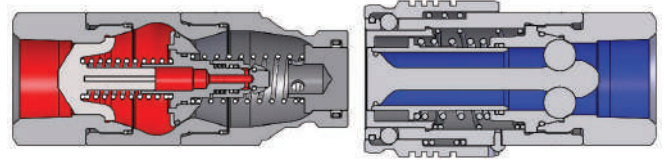

Paso 2: Cámara de Niple Evacuada

La válvula del niple se abre, entonces el socket de la válvula se abre, evacuando la cámara del niple al socket despresurizado.

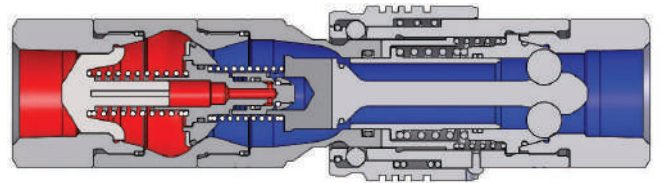

Paso 3: Liberación de Presión

La conexión continua con la válvula activada, liberando la presión atrapada dentro de la cámara del niple y al socket despresurizado.

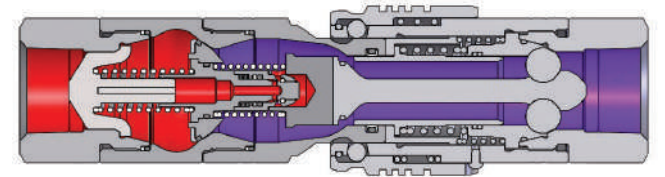

Paso 4: Completa la Conexión

La válvula principal puede abrirse fácilmente, ya que no hay presión atrapada, permitiendo al socket conectarse completamente al niple.

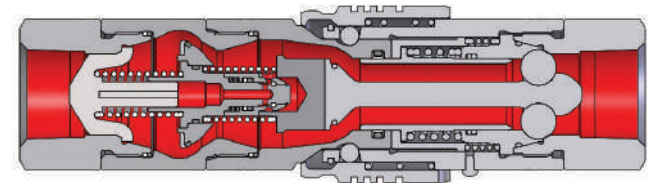

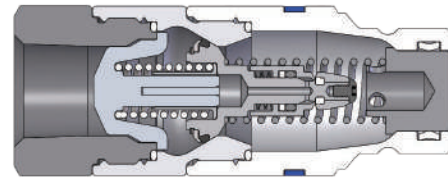

- Para usar con Coples Serie-HT

Medida	Serie-HTE Niple ISO 16028 "Conecte a Presión" Cara Plana (Roscas Hembra)							
	Detalle			Medida		DE Máximo		Hex pulg
	# Parte	Roscas	Material	pulg	mm	pulg	mm	
3/8"	HTE3F3	3/8" - 18 NPTF	acero	3.21	81.4	1.31	33.3	1-3/16"
	HTE3F4	1/2" - 14 NPTF	acero	3.25	82.6	1.30	33.0	1-1/8"
	HTE3BF4	1/2" - 14 BSPP	acero	3.25	82.6	1.30	33.0	1-1/8"
	HTE3OF4	3/4" - 16 ORB	acero	3.25	82.6	1.30	33.0	1-1/8"
1/2"	HTE4F4	1/2" - 14 NPTF	acero	3.40	86.4	1.30	33.0	1-3/16"
	HTE4BF4	1/2" - 14 BSPP	acero	3.40	86.4	1.30	33.0	1-3/16"
	HTE4OF4	3/4" - 16 ORB	acero	3.40	86.4	1.30	33.0	1-3/16"
	HTE4OF5	7/8" - 14 ORB	acero	3.40	86.4	1.30	33.0	1-1/2"
	HTE4F6	3/4" - 14 NPTF	acero	3.60	91.4	1.65	41.9	1-1/2"
	HTE4BF6	3/4" - 14 BPSS	acero	3.60	91.4	1.65	41.9	1-1/2"
	HTE4OF6	1-1/16" - 12 ORB	acero	3.60	91.4	1.65	41.9	1-1/2"
5/8"	HTE5OF5	7/8" - 14 ORB	acero	3.75	95.3	1.65	41.9	1-1/2"
	HTE5F6	3/4" - 14 NPTF	acero	3.75	95.3	1.65	41.9	1-1/2"
	HTE5BF6	3/4" - 14 BSPP	acero	3.75	95.3	1.65	41.9	1-1/2"
	HTE5OF6	1-1/16" - 12 ORB	acero	3.75	95.3	1.65	41.9	1-1/2"
3/4"	HTE6F6	3/4" - 14 NPTF	acero	4.25	108.0	1.96	49.8	1-1/2"
	HTE6BF6	3/4" - 14 BSPP	acero	4.25	108.0	1.96	49.8	1-1/2"
	HTE6OF6	1-1/16" - 12 ORB	acero	4.25	108.0	1.96	49.8	1-1/2"
	HTE6F8	1" - 11-1/2 NPTF	acero	4.40	111.8	1.96	49.8	1-3/4"
	HTE6BF8	1" - 11 BSPP	acero	4.40	111.8	1.96	49.8	1-3/4"
	HTE6OF8	1-5/16" - 12 ORB	acero	4.40	111.8	1.96	49.8	1-3/4"
1"	HTE8F8	1" - 11-1/2 NPTF	acero	4.88	124.0	1.96	49.8	1-3/4"
	HTE8BF8	1" - 11 BSPP	acero	4.88	124.0	1.96	49.8	1-3/4"
	HTE8OF8	1-5/16" - 12 ORB	acero	4.88	124.0	1.96	49.8	1-3/4"
	HTE8F10	1-1/4" - 11-1/2 NPTF	acero	5.00	127.0	2.47	62.7	2-3/16"
	HTE8BF10	1-1/4" - 11 BSPP	acero	5.00	127.0	2.47	62.7	2-3/16"
	HTE8OF10	1-5/8" - 12 ORB	acero	5.00	127.0	2.47	62.7	2-3/16"

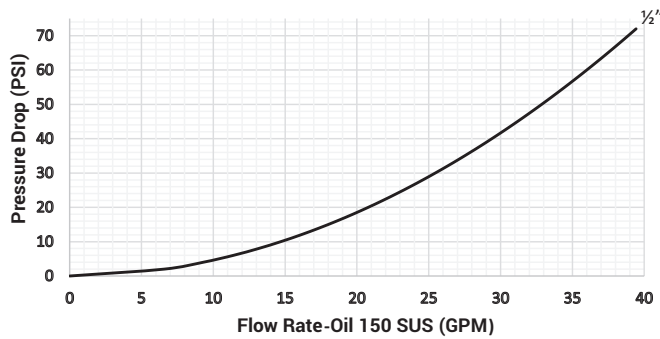

Información de Intercambio

- Intercambiable a ISO16028
- Parker FEM-Series, Snap-Tite 74-Series, Hansen FF, Eaton/Aeroquip FD89, Stucchi FIRG/Series A, Faster FFH/FFN/FFI/2FFN/2FFI, Safeway FF49-Series

Materiales

- Los componentes son maquinados con barras sólidas de acero o acero inoxidable 316
- Balines, anillos de retención, y resortes de acero inoxidable que extienden la vida del servicio
- Los componentes de acero son platinados con zinc niquelado que cumple con la norma ROHS
- Las mangas de acople son endurecidas para resistir la deformación y maximizar la vida del servicio
- Los nipples de acero son endurecidos para brindar un desempeño de trabajo pesado y resistencia

Componentes del Sello

- Nipples de 1/2" tienen válvula con sellos de poliuretano, con un rango de temperatura de -65°F a 212°F (-54°C a 100°C)
- Los coples tienen O-ring de poliuretano con un rango de temperatura de -65°F a 212°F (-54°C a 100°C)
- Los sellos auxiliares del nipple y cople son de nitrilo (buna-N), con un rango de temperatura de -40°F a 250°F (-40°C a 121°C)
- El anillo anti-extrusión PTFE o TPC-ET protege el sello de la válvula del cople del impulso dinámico por presión.

Tabla de Valores de Presión

Me- dida	Serie-HTZ ISO16028 Cara Plana															
	Cople/Niple Acero Conectado				Cople/Niple A.I. 316 Conectado				Cople Acero Sin Conectar				Niple Acero Sin Conectar			
	Trabajo Max.		Reventón		Trabajo Max.		Reventón		Trabajo Max.		Reventón		Trabajo Max.		Reventón	
	PSI	Bar	PSI	Bar	PSI	Bar	PSI	Bar	PSI	Bar	PSI	Bar	PSI	Bar	PSI	Bar
1/2"	5,000	345	20,000	1,379	3,400	234	17,000	1,172	5,000	345	20,000	1,379	5,000	345	20,000	1,379

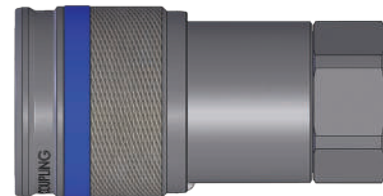
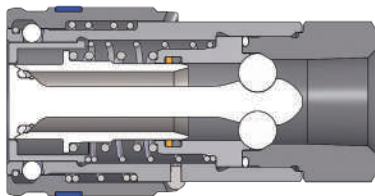

Medida	Serie-HTZ Cople ISO16028 "Conecta bajo presión" Cara Plana							
	Detalle			Medida		DE Máximo		Hex pulg
	# Parte	Roscas	Material	pulg	mm	pulg	mm	
1/2"	4HTZF4	1/2" -14 NPTF	acero	3.00	76.20	1.54	39.12	1-3/16"
	4HTZF6	3/4" - 14 NPTF	acero	3.22	81.79	1.65	41.91	1-1/2"
	4HTZOF4	3/4" - 16 ORB	acero	3.00	76.20	1.54	39.12	1-3/16"
	4HTZOF5	7/8" - 14 ORB	acero	3.22	81.79	1.65	41.91	1-1/2"
	4HTZOF6	1-1/16" - 12 ORB	acero	3.22	81.79	1.65	41.91	1-1/2"

Información de Intercambio

- Intercambio agrícola, Parker/Pioneer Serie 4000, Faster Serie NS/NV, Safeway Serie-S20, Stucchi Serie IR, Snap-Tite Serie-60
- Cumple con estándares de intercambio ISO16028 con Eaton/Hansen FF, Parker FEM, Snap-tite 74, Faster FFH/2FFN/2FFI, Stucchi A/FIRG, y Holmbury HQ/A/FIMC

Materiales

- Componentes maquinados con barras sólidas
- Balines, anillos de retención, y resortes de acero inoxidable que extienden la vida del servicio
- Los componentes de acero son platinados con cromo trivalente y cumplen con la norma ROHS
- Las mangas de acople son endurecidas para resistir la deformación y maximizar la vida del servicio.

Componentes del Sello

- Los coples Serie-HT tienen sellos O-ring de poliuretano con un rango de temperatura de **-65° a 212°F (-54°C a 100°C)**
- Los sellos auxiliares de la Serie-HT son de nitrilo (Buna-N), con un rango de temperatura de **-40°F a 250°F (-40°C a 121°C)**
- El anillo anti-extrusión PTFE o TPC-ET protege el sello de la válvula del cople del impulso dinámico por presión.
- Sellos de Nitrilo (Buna-N) son estándar en coples y nioples de serie-AG
- Los coples serie-AG tienen un anillo PTFE anti-extrusión

4AGHT4 Flow Chart

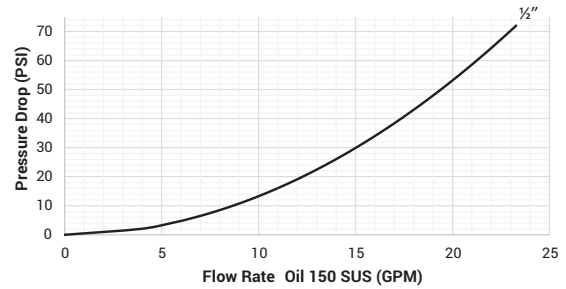

4HTAG4 Flow Chart

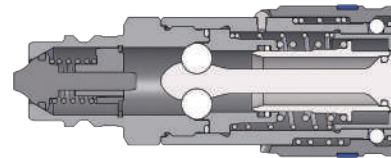
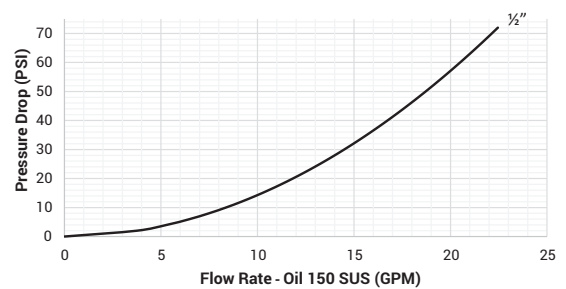

Serie HT-AG Cople ISO16028 Cara Plana x Adaptador Niple AG ISO7241-A

Medida	Detalle		Medida		DE Máximo	
	# Parte	Material	pulg	mm	pulg	mm
1/2"	4HTAG4	acero	3.89	98.81	1.57	39.88

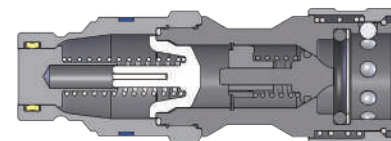

Serie HT-AG Cople ISO7241-A AG x Adaptador Niple ISO16028 Cara Plana

Medida	Detalle		Medida		DE Máximo	
	# Parte	Material	pulg	mm	pulg	mm
1/2"	4AGHT4	acero	4.15	105.41	1.51	38.35

Información de Intercambio

- Intercambiable con with Snap-Tite Serie-71

Materiales

- Los componentes son maquinados con barras sólidas de acero o acero inoxidable 316.
- Balines, anillos de retención, y resortes de acero inoxidable que extienden la vida del servicio
- Los componentes de acero son platinados con cromo trivalente y cumplen con la norma ROHS
- Las mangas de acople son endurecidas para resistir la deformación y maximizar la vida del servicio.
- Los nipples de acero son endurecidos para brindar un desempeño de trabajo pesado y resistencia

Componentes del Sello

- Sellos de Nitrilo (Buna-N) estándar brindan un rango de temperatura de **-40°F a 250°F (-40°C a 121°C)**
- Todos los acoples incorporan un anillo PTFE anti-extrusión para proteger los componentes del sello de daños por impulso dinámico



Tabla de Valores de Presión

Medida	Serie-ST Cara Plana Trabajo Pesado							
	Cople/Niple Acero Conectado				Cople/Niple A.I. 316 Conectado			
	Trabajo Máximo		Reventón		Trabajo Máximo		Reventón	
	PSI	Bar	PSI	Bar	PSI	Bar	PSI	Bar
1/4"	10,000	700	27,300	1,800	5,000	345	28,000	1,900
3/8"	10,000	700	27,300	1,800	5,000	345	28,000	1,900
1/2"	10,000	700	22,500	1,500	5,000	345	25,000	1,700
3/4"	7,500	500	20,200	1,400	5,000	345	22,800	1,550
1"	7,500	500	19,400	1,300	4,000	275	18,500	1,250
1"-V2	8,500	585	25,900	1,750	-	-	-	-
2"	5,000	345	16,000	1,100	3,000	200	10,000	700

Especificaciones Técnicas

Medida	Estándar Intercambio				Parámetros Funcionales				
	Ejército USA	Gobierno USA	Estántar Int	Estándar ANSI/NFPA	Cant Balines	Inclusión Aire	Pérdida Fluido	Vacío pulg HG	Flujo ΔP = 22 PSI
1/4"	-	-	-	-	10	0.01cc	0.02cc	N/R	3.1 GPM
3/8"	-	-	-	-	10	0.02cc	0.02cc	N/R	7.7 GPM
1/2"	-	-	-	-	12	0.03cc	0.03cc	N/R	15.0 GPM
3/4"	-	-	-	-	12	0.04cc	0.06cc	N/R	30.0 GPM
1"	-	-	-	-	12	0.06cc	0.07cc	N/R	45.0 GPM
1"-V2	-	-	-	-	12	0.09cc	0.10cc	N/R	50.0 GPM
2"	-	-	-	-	15	3.14cc	5.25cc	N/R	150.0 GPM

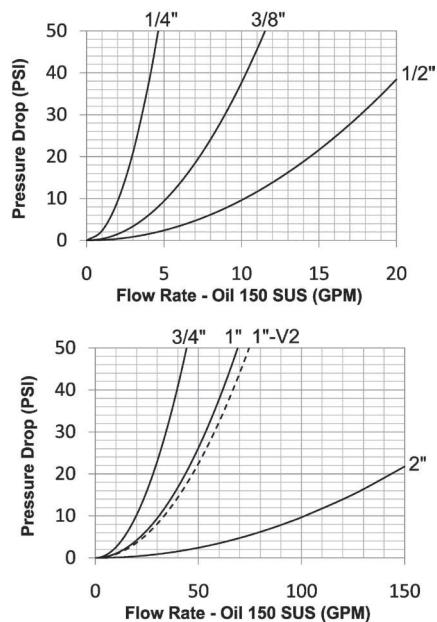
Opciones Disponibles

Medida	Opciones de Sellado Estándar				Opciones de Sello Kalrez®			Manga	Tratamiento
	FKM	EPDM	Mil-Nitrilo	Nitrilo Combustible	4079	6375	7075	Seguro	Oxy-Clean
1/4"	F-	P-	M-	JF-	K4-	K6-	K7-	-LS	-C1
3/8"	F-	P-	M-	JF-	K4-	K6-	K7-	-LS	-C1
1/2"	F-	P-	M-	JF-	K4-	K6-	K7-	-LS	-C1
3/4"	F-	P-	M-	JF-	K4-	K6-	K7-	-LS	-C1
1"	F-	P-	M-	JF-	K4-	K6-	K7-	-LS	-C1
1"-V2	F-	P-	M-	JF-	K4-	K6-	K7-	-LS	-C1
2"	F-	P-	M-	JF-	K4-	K6-	K7-	-LS	-C1

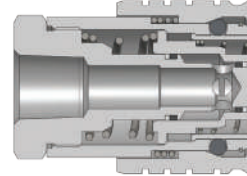
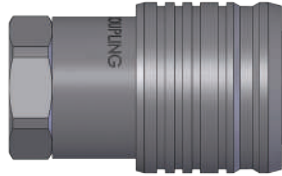

Serie-ST Cople Cara Plana Trabajo Pesado (Roscas Hembra)

Medida	Detalle			Medida		DE Máximo		Hex pulg
	# Parte	Roscas	Material	pulg	mm	pulg	mm	
1/4"	2STF2	1/4" - 18 NPTF	acero	1.96	49.8	1.23	31.2	15/16"
	2STF2-SS	1/4" - 18 NPTF	A.I. 316	1.96	49.8	1.23	31.2	15/16"
	2STBF2	1/4" - 19 BSPP	acero	1.96	49.8	1.23	31.2	15/16"
	2STBF2-SS	1/4" - 19 BSPP	A.I. 316	1.96	49.8	1.23	31.2	15/16"
3/8"	3STF2	1/4" - 18 NPTF	acero	2.36	59.9	1.60	40.6	1-3/16"
	3STF3	3/8" - 18 NPTF	acero	2.36	59.9	1.60	40.6	1-3/16"
	3STF3-SS	3/8" - 18 NPTF	A.I. 316	2.36	59.9	1.60	40.6	1-3/16"
	3STBF3	3/8" - 19 BSPP	acero	2.36	59.9	1.60	40.6	1-3/16"
	3STBF3-SS	3/8" - 19 BSPP	A.I. 316	2.36	59.9	1.60	40.6	1-3/16"
	3STF4	1/2" - 14 NPTF	acero	2.36	59.9	1.60	40.6	1-3/16"
	3STF4-SS	1/2" - 14 NPTF	A.I. 316	2.36	59.9	1.60	40.6	1-3/16"
	3STBF4	1/2" - 14 BSPP	acero	2.36	59.9	1.60	40.6	1-3/16"
1/2"	3STBF4-SS	1/2" - 14 BSPP	A.I. 316	2.36	59.9	1.60	40.6	1-3/16"
	4STF4	1/2" - 14 NPTF	acero	2.77	70.4	1.98	50.3	1-1/2"
	4STF4-SS	1/2" - 14 NPTF	A.I. 316	2.77	70.4	1.98	50.3	1-1/2"
	4STBF4	1/2" - 14 BSPP	acero	2.77	70.4	1.98	50.3	1-1/2"
	4STBF4-SS	1/2" - 14 BSPP	A.I. 316	2.77	70.4	1.98	50.3	1-1/2"
3/4"	4STOF4	3/4" - 16 ORB	acero	2.77	70.4	1.98	50.3	1-1/2"
	6STF6	3/4" - 14 NPTF	acero	3.03	77.0	2.35	59.7	1-3/4"
	6STF6-SS	3/4" - 14 NPTF	A.I. 316	3.03	77.0	2.35	59.7	1-3/4"
	6STBF6	3/4" - 14 BSPP	acero	3.03	77.0	2.35	59.7	1-3/4"
	6STBF6-SS	3/4" - 14 BSPP	A.I. 316	3.03	77.0	2.35	59.7	1-3/4"
1"	6STOF6	1-1/16" - 12 ORB	acero	3.03	77.0	2.35	59.7	1-3/4"
	8STF8	1" - 11-1/2 NPTF	acero	3.33	84.6	2.73	69.3	2"
	8STF8-SS	1" - 11-1/2 NPTF	A.I. 316	3.33	84.6	1.55	39.3	2"
	8STBF8	1" - 11 BSPP	acero	3.33	84.6	2.73	69.3	2"
	8STBF8-SS	1" - 11 BSPP	A.I. 316	3.33	84.6	2.73	69.3	2"
	8STOF8	1-5/16" - 12 ORB	acero	3.33	84.6	2.73	69.3	2"
	8STF10	1-1/4" - 11-1/2 NPTF	acero	3.67	93.2	2.73	69.3	2"
	8STF10-SS	1-1/4" - 11-1/2 NPTF	A.I. 316	3.67	93.2	2.73	69.3	2"
	8STBF10	1-1/4" - 11 BSPP	acero	3.67	93.2	2.73	69.3	2"
	8STBF10-SS	1-1/4" - 11 BSPP	A.I. 316	3.67	93.2	2.73	69.3	2"
	8STOF10	1-5/8" - 12 ORB	acero	3.67	93.2	2.73	69.3	2"

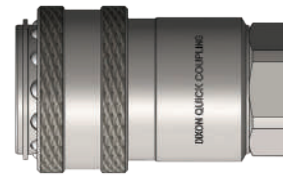
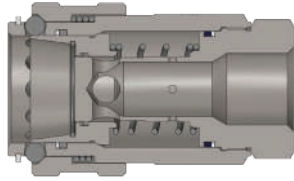

Medida	Serie-ST Cople Cara Plana Trabajo Pesado (Roscas Hembra)							
	Detalle			Medida		DE Máximo		Hex pulg
	# Parte	Roscas	Material	pulg	mm	pulg	mm	
2"	16STF12	1-1/2" - 11-1/2 NPTF	acero	6.20	157.5	4.47	113.5	3.78"
	16STBF12	1-1/2" - 11 BSPP	acero	6.20	157.5	4.47	113.5	3.78"
	16STOF12	1-7/8" - 12 ORB	acero	6.20	157.5	4.47	113.5	3.78"
	16STF16	2" - 11-1/2 NPTF	acero	6.20	157.5	4.47	113.5	3.78"
	16STF16-SS	2" - 11-1/2 NPTF	A.I. 316	6.20	157.5	4.47	113.5	3.78"
	16STBF16	2" - 11 BSPP	acero	6.20	157.5	4.47	113.5	3.78"
	16STOF16	2-1/2" - 12 ORB	acero	6.20	157.5	4.47	113.5	3.78"

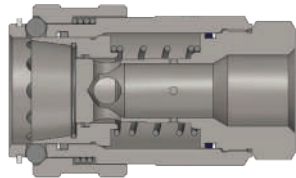

Medida	Serie-ST Cople Cara Plana Trabajo Pesado 'Estilo Antiguo' (Roscas Hembra)							
	Detalle			Medida		DE Máximo		Hex pulg
	# Parte	Roscas	Material	pulg	mm	pulg	mm	
1"	8STF8-V2	1" - 11-1/2 NPTF	acero	4.55	115.6	2.74	69.6	2"
	8STBF8-V2	1" - 11 BSPP	acero	4.55	115.6	2.74	69.6	2"
	8STF10-V2	1-1/4" - 11-1/2 NPTF	acero	4.90	124.5	2.74	69.6	2"

Serie-ST Perfil

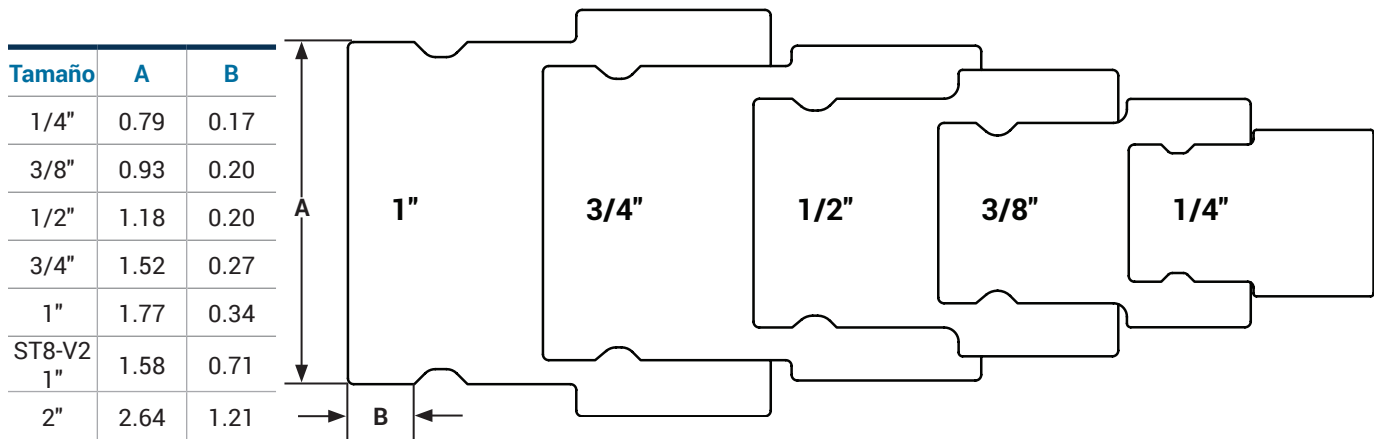

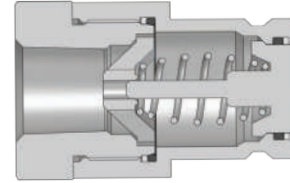

Serie-ST Niple Cara Plana Trabajo Pesado (Roscas Hembra)

Medida	Serie-ST Niple Cara Plana Trabajo Pesado (Roscas Hembra)							
	Detalle			Medida		DE Máximo		Hex pulg
	# Parte	Roscas	Material	pulg	mm	pulg	mm	
1/4"	ST2F2	1/4" - 18 NPTF	acero	1.84	46.7	0.90	22.9	13/16"
	ST2F2-SS	1/4" - 18 NPTF	A.I. 316	1.84	46.7	0.90	22.9	13/16"
	ST2BF2	1/4" - 19 BSPP	acero	1.84	46.7	0.90	22.9	13/16"
	ST2BF2-SS	1/4" - 19 BSPP	A.I. 316	1.84	46.7	0.90	22.9	13/16"
3/8"	ST3F2	1/4" - 18 NPTF	acero	2.32	58.9	1.48	37.6	1"
	ST3F3	3/8" - 18 NPTF	acero	2.32	58.9	1.48	37.6	1"
	ST3F3-SS	3/8" - 18 NPTF	A.I. 316	2.32	58.9	1.48	37.6	1"
	ST3BF3	3/8" - 19 BSPP	acero	2.32	58.9	1.48	37.6	1"
	ST3BF3-SS	3/8" - 19 BSPP	A.I. 316	2.32	58.9	1.48	37.6	1"
	ST3F4	1/2" - 14 NPTF	acero	2.32	58.9	1.48	37.6	1"
	ST3F4-SS	1/2" - 14 NPTF	A.I. 316	2.32	58.9	1.48	37.6	1"
	ST3BF4	1/2" - 14 BSPP	acero	2.32	58.9	1.48	37.6	1"
1/2"	ST4F4	1/2" - 14 NPTF	acero	2.37	60.2	1.65	41.9	1-1/2"
	ST4F4-SS	1/2" - 14 NPTF	A.I. 316	2.37	60.2	1.65	41.9	1-1/2"
	ST4BF4	1/2" - 14 BSPP	acero	2.37	60.2	1.65	41.9	1-1/2"
	ST4BF4-SS	1/2" - 14 BSPP	A.I. 316	2.37	60.2	1.65	41.9	1-1/2"
3/4"	ST4OF4	3/4" - 16 ORB	acero	2.37	60.2	1.65	41.9	1-1/2"
	ST6F6	3/4" - 14 NPTF	acero	2.96	75.2	1.92	48.8	1-3/4"
	ST6F6-SS	3/4" - 14 NPTF	A.I. 316	2.96	75.2	1.92	48.8	1-3/4"
	ST6BF6	3/4" - 14 BSPP	acero	2.96	75.2	1.92	48.8	1-3/4"
	ST6BF6-SS	3/4" - 14 BSPP	A.I. 316	2.96	75.2	1.92	48.8	1-3/4"
	ST6OF6	1-1/16" - 12 ORB	acero	2.96	75.2	1.92	48.8	1-3/4"
1"	ST8F8	1" - 11-1/2 NPTF	acero	3.22	81.8	2.10	53.3	1-7/8"
	ST8F8-SS	1" - 11-1/2 NPTF	A.I. 316	3.22	81.8	2.10	53.3	1-7/8"
	ST8BF8	1" - 11 BSPP	acero	3.22	81.8	2.10	53.3	1-7/8"
	ST8BF8-SS	1" - 11 BSPP	A.I. 316	3.22	81.8	2.10	53.3	1-7/8"
	ST8OF8	1-5/16" - 12 ORB	acero	3.22	81.8	2.10	53.3	1-7/8"
	ST8F10	1-1/4" - 11-1/2 NPTF	acero	3.48	88.4	2.20	55.9	2"
	ST8F10-SS	1-1/4" - 11-1/2 NPTF	A.I. 316	3.48	88.4	2.20	55.9	2"
	ST8BF10	1-1/4" - 11 BSPP	acero	3.48	88.4	2.20	55.9	2"
	ST8BF10-SS	1-1/4" - 11 BSPP	A.I. 316	3.48	88.4	2.20	55.9	2"
	ST8OF10	1-5/8" - 12 ORB	acero	3.48	88.4	2.20	55.9	2"

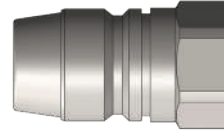
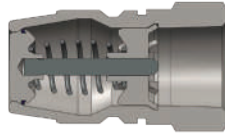

Medida	Serie-ST Niple Cara Plana Trabajo Pesado (Roscas Hembra)							
	Detalle			Medida		DE Máximo		Hex pulg
	# Parte	Roscas	Material	pulg	mm	pulg	mm	
2"	ST16F12	1-1/2" - 11-1/2 NPTF	acero	4.50	114.3	3.48	88.4	3-1/4"
	ST16BF12	1-1/2" - 11 BSPP	acero	4.50	114.3	3.48	88.4	3-1/4"
	ST16OF12	1-7/8" - 12 ORB	acero	4.50	114.3	3.48	88.4	3-1/4"
	ST16F16	2" - 11-1/2 NPTF	acero	4.50	114.3	3.48	88.4	3-1/4"
	ST16F16-SS	2" - 11-1/2 NPTF	A.I. 316	4.50	114.3	3.48	88.4	3-1/4"
	ST16BF16	2" - 11 BSPP	acero	4.50	114.3	3.48	88.4	3-1/4"
	ST16OF16	2-1/2" - 12 ORB	acero	4.50	114.3	3.48	88.4	3-1/4"

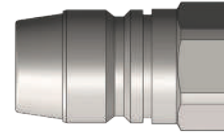
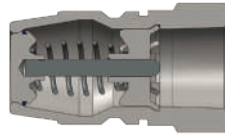

Medida	Serie-ST Niple Cara Plana Trabajo Pesado 'Estilo Antiguo' (Roscas Hembra)							
	Detalle			Medida		DE Máximo		Hex pulg
	# Parte	Roscas	Material	pulg	mm	pulg	mm	
1"	ST8F8-V2	1" - 11-1/2 NPTF	acero	3.26	82.8	1.92	48.8	1-3/4"
	ST8BF8-V2	1" - 11 BSPP	acero	3.26	82.8	1.92	48.8	1-3/4"
	ST8F10-V2	1-1/4" - 11-1/2 NPTF	acero	3.50	88.9	1.98	50.3	2"



Medida	Serie-ST Tapón Guarda Polvo			
	Detalle			Cuerpo
	# Parte	Cuerda		
1/4"	2STDP-A	cable de acero		aluminio
3/8"	3STDP-A	cable de acero		aluminio
1/2"	4STDP-A	cable de acero		aluminio
3/4"	6STDP-A	cable de acero		aluminio
1"	8STDP-A	cable de acero		aluminio
1"-V2	8STDP-A-V2	cable de acero		aluminio
2"	16STDP-A	cable de acero		aluminio



Medida	Serie-ST Tapa Guarda Polvo			
	Detalle			Cuerpo
	# Parte	Cuerda		
1/4"	ST2DC-A	cable de acero		aluminio
3/8"	ST3DC-A	cable de acero		aluminio
1/2"	ST4DC-A	cable de acero		aluminio
3/4"	ST6DC-A	cable de acero		aluminio
1"	ST8DC-A	cable de acero		aluminio
1"-V2	ST8DC-A-V2	cable de acero		aluminio
2"	ST16DC-A	cable de acero		aluminio

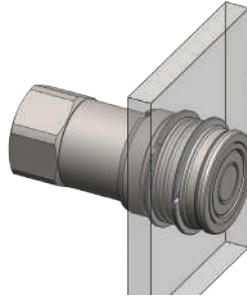

Medida	Serie-ST Kit Cople Pasamuro Cara Plana Trabajo Pesado			
	Detalle			Contenido de Kit Pasamuros
	# Parte	DI Montaje	Material	
1/4"	2ST-BMK	1.250"	acero	dos anillos de retención 360°
3/8"	3ST-BMK	1.625"	acero	dos anillos de retención 360°
1/2"	4ST-BMK	2.000"	acero	dos anillos de retención 360°
3/4"	6ST-BMK	2.375"	acero	dos anillos de retención 360°

Medida	Serie-ST Kit de Sellos para Cople Pasamuro Cara Plana Trabajo Pesado			
	Detalle			Contenido de Kit de Sellos
	# Parte	Estilo de Cople	Material de Sello	
1/4"	2ST-SKIT	Todos	nitrilo	dos sellos y anillos anti-extrusión
3/8"	3ST-SKIT	Todos	nitrilo	dos sellos y anillos anti-extrusión
1/2"	4ST-SKIT	Todos	nitrilo	dos sellos y anillos anti-extrusión
3/4"	6ST-SKIT	Todos	nitrilo	dos sellos y anillos anti-extrusión
1"	8ST-SKIT	Todos	nitrilo	dos sellos y anillos anti-extrusión
1"	8ST-SKIT-V2	Todos	nitrilo	tres sellos y dos anillos anti-extrusión
2"	16ST-SKIT	Todos	nitrilo	tres sellos y dos anillos anti-extrusión

Medida	Serie-ST Kit de Sellos para Niple Cara Plana Trabajo Pesado			
	Detalle			Contenido de Kit de Sellos
	# Parte	Estilo de Cople	Material de Sello	
1/4"	ST2-SKIT	Todos	nitrilo	O-ring de válvula y O-ring de adaptador
3/8"	ST3-SKIT	Todos	nitrilo	O-ring de válvula y O-ring de adaptador
1/2"	ST4-SKIT	Todos	nitrilo	O-ring de válvula y O-ring de adaptador
3/4"	ST6-SKIT	Todos	nitrilo	O-ring de válvula y O-ring de adaptador
1"	ST8-SKIT	Todos	nitrilo	O-ring de válvula y O-ring de adaptador
2"	ST16-SKIT	Todos	nitrilo	Sello principal de válvula

Información de Intercambio

- Intercambiable a ISO15171-1
- Parker Serie-PD, Eaton/Aeroquip FD90

Materiales

- Los componentes son maquinados con barras sólidas de acero
- Resortes de acero inoxidable, balines y anillos de retención de acero al carbón.
- Los nipples son maquinados con barras sólidas de acero y endurecidos
- Los componentes de acero son platinados con cromo trivalente y cumplen con la norma ROHS

Componentes del Sello

- Sellos de Nitrilo (Buna-N) estándar brindan un rango de temperatura de **-40°F a 250°F (-40°C a 121°C)**
- El anillo PTFE anti-extrusión protege el O-ring del cople principal de daños por impulso dinámico de presión



Tabla de Valores de Presión

Me- dida	Serie-PD ISO15171-1 Intercambio Diagnóstico							
	Cople/Niple Acero Conectado				Niple Acero Desconectado			
	Trabajo Máximo		Reventón		Trabajo Máximo		Reventón	
	PSI	Bar	PSI	Bar	PSI	Bar	PSI	Bar
1/8"	6,000	400	18,700	1,300	6,000	400	24,000	1,600

Especificaciones Técnicas

Medida	Estándar Intercambio				Parámetros Funcionales				
	Ejército USA	Gobierno USA	Estántar Int	Estándar ANSI/NFPA	Cant Ba- lines	Inclusión Aire	Pérdida Fluido	Vacío Rating	Flujo ΔP = 22 PSI
1/8"	-	-	ISO15171-1	SAE J1502	10	0.02	0.1	27.4	0.8

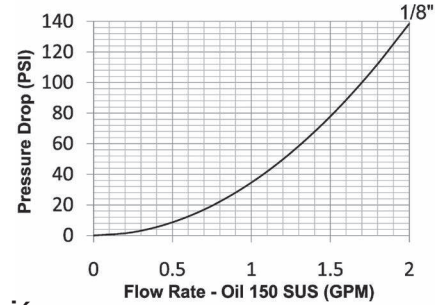
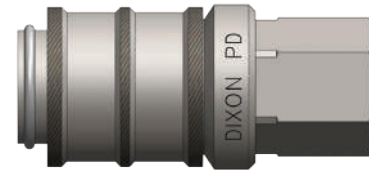
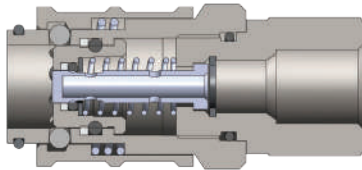

Serie-PD Cople Diagnóstico ISO15171-1 (Roscas Hembra)

Medida	Detalle			Medida		DE Máximo		Hex mm
	# Parte	Roscas	Material	pulg	mm	pulg	mm	
	1/8"	1PDF1	1/8" - 27 NPT	acero	2.13	54.1	0.98	
	1PDF2	1/4" - 18 NPT	acero	2.13	54.1	0.98	24.8	21

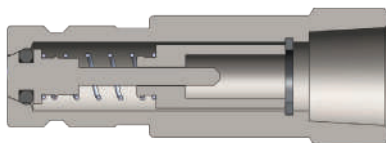

Serie-PD Niple Diagnóstico ISO15171-1 (Roscas Hembra)

Medida	Detalle			Medida		Mazimum OD		Hex mm
	# Parte	Roscas	Material	pulg	mm	pulg	mm	
	1/8"	PD1F1	1/8" - 27 NPT	acero	1.88	47.7	0.76	
	PD1F2	1/4" - 18 NPT	acero	1.88	47.7	0.76	19.3	17

Coples Hidráulicos: Serie-PD

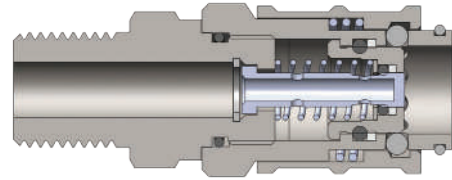

Serie-PD Cople Diagnóstico ISO15171-1 (Roscas Macho)

Medida	Detalle			Medida		DE Máximo		Hex mm
	# Parte	Roscas	Material	pulg	mm	pulg	mm	
1/8"	1PDM2	1/4" - 18 NPT	acero	2.28	57.9	0.98	24.9	21

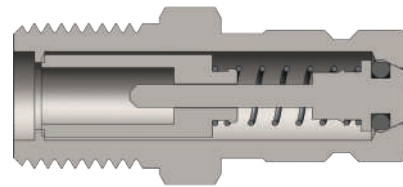

Serie-PD Niple Diagnóstico ISO15171-1 (Roscas Macho)

Medida	Detalle			Medida		DE Máximo		Hex mm
	# Parte	Roscas	Material	pulg	mm	pulg	mm	
1/8"	PD1M1	1/8" - 27 NPT	acero	1.98	50.2	0.76	19.3	17
	PD1M2	1/4" - 18 NPT	acero	1.48	37.5	0.76	19.3	17

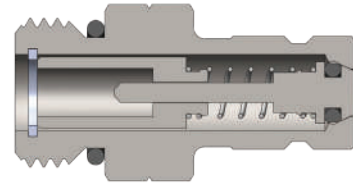

Serie-PD Niple Diagnóstico ISO15171-1 (Roscas Macho ORB)

Medida	Detalle			Medida		DE Máximo		Hex mm
	# Parte	Roscas	Material	pulg	mm	pulg	mm	
1/8"	PD10M2	7/16" - 20 ORB	acero	1.93	49.0	0.76	19.3	17
	PD10M3	9/16" - 18 ORB	acero	1.48	37.5	0.76	19.3	17

Serie-PD Tapa Guarda Polvo

Medida	Detalle	
	# Parte	Material
1/8"	H1DC	nitrilo

Serie-PF Perfil

Tamaño	A	B
1/8"	0.49	0.19

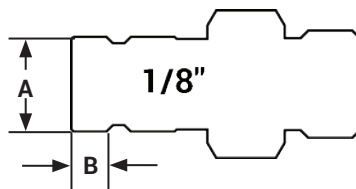

Información de Intercambio

- Stucchi Serie VEP-P/VEP-HD, Serie DNP PST4/FSI, Serie Voswinkel FT, Serie Parker FET y Holmbury Serie HFT

Componentes del Sellos

- Los nipples tienen sellos PTFE con rango de temperatura de -40°F a 250°F (-40°C a 121°C)
- Los nipples de 3/8" tienen sellos moldeados de poliuretano con un rango de temperatura de -65°F a 212°F (-54°C a 100°C)
- Los vástagos de 3/8" a 3/4" tienen sellos de acetal, con rango de temperatura de -65°F a 212°F (-54°C a 100°C)
- Los vástagos de 1" a 2" tienen sellos de poliuretano con un rango de temperatura de -65°F a 212°F (-54°C a 100°C)
- Los sellos auxiliares del cople y nipple son de nitrilo (buna-N), con rango de temperatura de -40°F a 250°F (-40°C a 121°C)
- El anillo anti-extrusión TPC-ET protege el sello de la válvula del cople del impulso dinámico por presión

Materiales

- Los componentes son maquinados con barras sólidas de acero
- Anillos de retención y resortes de acero inoxidable maximizan la resistencia a la corrosión y extienden la vida del servicio
- Los componentes de acero son platinados con cromo trivalente y cumplen con la norma ROHS

Válvula de dos niveles para proteger el sellado de los componentes durante conexiones presurizadas y desconexión.

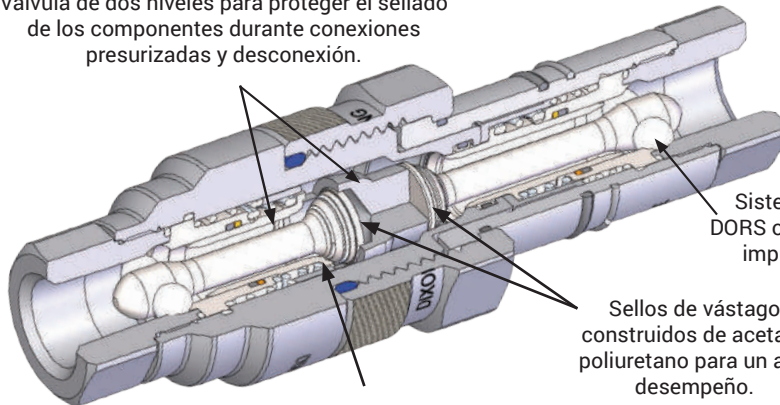

Sistema de retención DORS optimiza el flujo y el impulso de presión.

Sellos de vástago contruidos de acetal y poliuretano para un alto desempeño.

El sistema Posi-lock asegura la válvula durante las condiciones de flujo sobre-tensas para prevenir daños por exceso de flujo.



Tabla de Valores de Presión

Serie-VEP Intercambio

	Valor de Presión				Presión de Reventón						Presión Máxima Conectada ³		Presión Máxima Desconectada ³		Valor Flujo ΔP=21.75 PSI	
	Trabajo ISO ¹		Impulso Max ²		Conectado		Cople		Niple		PSI	Bar	PSI	Bar	GPM	L/min
	PSI	Bar	PSI	Bar	PSI	Bar	PSI	Bar	PSI	Bar	PSI	Bar	PSI	Bar		
1/4"	6,000	400	9,000	625	24,000	1,650	22,000	1,525	22,000	1,525	5,500	375	5,500	375	3.5	13
3/8"	5,500	375	8,000	550	22,000	1,525	18,000	1,250	20,000	1,375	4,500	300	4,500	300	10.5	40
1/2"	5,500	375	8,000	550	22,000	1,525	18,000	1,250	20,000	1,375	4,500	300	4,500	300	17.5	66
3/4"	5,500	375	8,000	550	22,000	1,525	18,000	1,250	20,000	1,375	4,500	300	4,500	300	22.7	85
1"	5,500	375	7,500	525	22,000	1,525	14,500	1,000	20,000	1,375	3,625	250	3,625	250	32.5	123
1-1/4"	5,000	350	7,000	475	20,000	1,375	14,500	1,000	16,000	1,100	3,625	250	3,625	250	46.4	174
1-1/2"	4,500	300	5,800	400	18,000	1,250	12,000	8,325	14,500	1,000	3,000	200	3,000	200	95.0	360
2"	4,000	275	5,000	350	18,000	1,250	12,000	8,325	14,500	1,000	3,000	200	3,000	200	172.5	653

¹El impulso de los acoples se probó de acuerdo con ISO18869 para 1,000,000 ciclos conectados y 100.000 ciclos desconectados a 133% de presión de trabajo ISO.

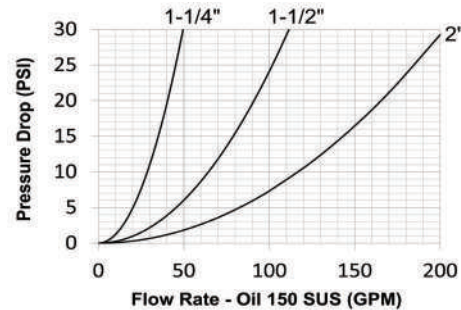
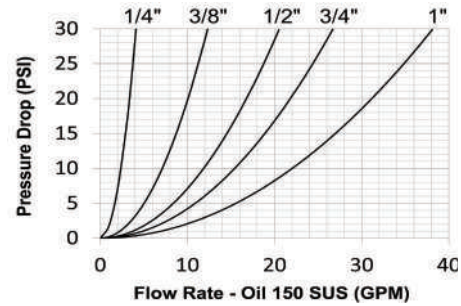
²El impulso de los acoples se probó de acuerdo con ISO18869 para 100,000 ciclos conectados y desconectados a un máximo de presión listado

³La temperatura máxima para conectar/desconectar no debe exceder los 150°F (65°C)

Como Conectar y Desconectar un Cople Serie-VEP

1. Antes de conectar, limpia todas las superficies y roscas en ambas partes, después tira de la manga del cople hacia adelante.
2. Para iniciar la conexión, alinea el cople y niple, empujando/girando la manga hacia el niple mientras se une a las roscas. Mantén ambas partes alineadas durante el proceso de conexión
3. Permite a las roscas tirar del cople hacia el niple; no empujes el cople dentro del niple.
4. La primera fase de la conexión debe ser roscada a mano, sin el uso de herramientas. Por favor nota que la conexión de la manga puede verse afectada cuando se acumula la suciedad y polvo en las roscas - remueve la suciedad con una tela, aire comprimido o un cepillo
5. La segunda fase de la conexión puede requerir una llave si la presión es mayor a la anticipada.
6. Continúa roscando la manga del cople dentro del niple hasta que el extremo de la manga se junte con el cuerpo del niple
7. Para desconectar, utiliza una llave para liberar la manga del cople y manten ambas partes alineadas durante el proceso de desconexión.

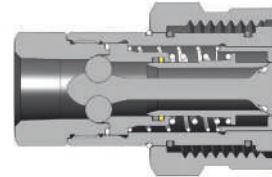
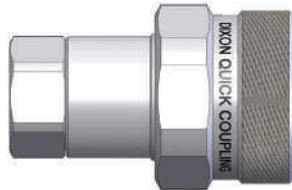

Medida	Serie-VEP Cople (Roscas Hembra)							
	Detalle			Medida		DE Máximo		Hex mm
	# Parte	Roscas	Materiales	pulg	mm	pulg	mm	
1/4"	2VEPF2	1/4" - 18 NPTF	acero	2.14	54.4	1.49	37.8	22
	2VEPBF2	1/4" - 19 BSPP	acero	2.14	54.4	1.49	37.8	22
	2VEPOF3	9/16" - 18 ORB	acero	2.14	54.4	1.49	37.8	22
3/8"	3VEPF3	3/8" - 18 NPTF	acero	2.55	64.8	1.62	41.1	25
	3VEPBF3	3/8" - 19 BSPP	acero	2.55	64.8	1.62	41.1	25
	3VEPOF4	3/4" - 16 ORB	acero	2.77	70.4	1.62	41.1	25
	3VEPF4	1/2" - 14 NPTF	acero	2.77	70.4	1.62	41.1	28
	3VEPBF4	1/2" - 14 BSPP	acero	2.77	70.4	1.62	41.1	28
1/2"	4VEPF4	1/2" - 14 NPTF	acero	3.08	78.2	1.98	50.3	30
	4VEPBF4	1/2" - 14 BSPP	acero	3.08	78.2	1.98	50.3	30
	4VEPOF4	3/4" - 16 ORB	acero	3.08	78.2	1.98	50.3	30
	4VEPOF5	7/8" - 14 ORB	acero	3.18	80.8	1.98	50.3	32
	4VEPF6	3/4" - 14 NPTF	acero	3.38	85.9	1.98	50.3	38
	4VEPBF6	3/4" - 14 BSPP	acero	3.38	85.9	1.98	50.3	38
	4VEPOF6	1-1/16" - 12 ORB	acero	3.58	90.9	1.98	50.3	38
3/4"	6VEPF6	3/4" - 14 NPTF	acero	3.37	85.6	2.19	55.6	38
	6VEPBF6	3/4" - 14 BSPP	acero	3.37	85.6	2.19	55.6	38
	6VEPOF6	1-1/16" - 12 ORB	acero	3.37	85.6	2.19	55.6	38
1"	8VEPF8	1" - 11-1/2 NPTF	acero	3.89	98.8	2.46	62.5	44
	8VEPF8-SS	1" - 11-1/2 NPTF	A.I. 316 acero	3.89	98.8	2.46	62.5	44
	8VEPBF8	1" - 11 BSPP	acero	3.89	98.8	2.46	62.5	44
	8VEPOF8	1-5/16" - 12 ORB	acero	3.89	98.8	2.46	62.5	44
1-1/4"	10VEPF10	1-1/4" - 11-1/2 NPTF	acero	4.40	111.8	2.70	68.6	55
	10VEPBF10	1-1/4" - 11 BSPP	acero	4.40	111.8	2.70	68.6	55
	10VEPOF10	1-5/8" - 12 ORB	acero	4.40	111.8	2.70	68.6	55
1-1/2"	12VEPF12	1-1/2" - 11-1/2 NPTF	acero	5.28	134.1	3.74	95.0	63
	12VEPBF12	1-1/2" - 11 BSPP	acero	5.28	134.1	3.74	95.0	63
	12VEPOF12	1-7/8" - 12 ORB	acero	5.28	134.1	3.74	95.0	63
2"	16VEPF16	2" - 11-1/2 NPTF	acero	9.42	239.3	7.39	187.7	89
	16VEPBF16	2" - 11 BSPP	acero	9.42	239.3	7.39	187.7	89
	16VEPOF16	2-1/2" - 12 ORB	acero	9.42	239.3	7.39	187.7	89

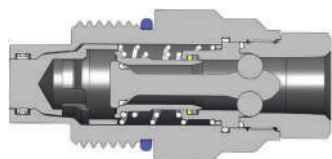

Medida	Serie-VEP Niple (Roscas Hembra)							
	Detalle			Medida		DE Máximo		Hex mm
	# Parte	Roscas	Material	pulg	mm	pulg	mm	
1/4"	VEP2F2	1/4" - 18 NPTF	acero	2.67	67.8	1.35	34.3	22
	VEP2BF2	1/4" - 19 BSPP	acero	2.67	67.8	1.35	34.3	22
	VEP2OF3	9/16" - 18 ORB	acero	2.67	67.8	1.35	34.3	22
3/8"	VEP3F3	3/8" - 18 NPTF	acero	3.28	83.3	1.48	37.6	25
	VEP3BF3	3/8" - 19 BSPP	acero	3.28	83.3	1.48	37.6	25
	VEP3OF4	3/4" - 16 ORB	acero	3.50	88.9	1.48	37.6	25
	VEP3F4	1/2" - 14 NPTF	acero	3.50	88.9	1.48	37.6	28
	VEP3BF4	1/2" - 14 BSPP	acero	3.50	88.9	1.48	37.6	28
1/2"	VEP4F4	1/2" - 14 NPTF	acero	3.87	98.3	1.86	47.2	30
	VEP4BF4	1/2" - 14 BSPP	acero	3.87	98.3	1.86	47.2	30
	VEP4OF4	3/4" - 16 ORB	acero	3.87	98.3	1.86	47.2	30
	VEP4OF5	7/8" - 14 ORB	acero	3.97	100.8	1.86	47.2	32
	VEP4F6	3/4" - 14 NPTF	acero	4.07	103.4	1.86	47.2	38
	VEP4BF6	3/4" - 14 BSPP	acero	4.07	103.4	1.86	47.2	38
	VEP4OF6	1-1/16" - 12 ORB	acero	4.27	108.5	1.86	47.2	38
3/4"	VEP6F6	3/4" - 14 NPTF	acero	4.12	104.6	1.98	50.3	38
	VEP6BF6	3/4" - 14 BSPP	acero	4.12	104.6	1.98	50.3	38
	VEP6OF6	1-1/16" - 12 ORB	acero	4.12	104.6	1.98	50.3	38
1"	VEP8F8	1" - 11-1/2 NPTF	acero	4.95	125.7	2.20	55.9	44
	VEP8F8-SS	1" - 11-1/2 NPTF	A.I. 316 acero	4.95	125.7	2.20	55.9	44
	VEP8BF8	1" - 11 BSPP	acero	4.95	125.7	2.20	55.9	44
	VEP8OF8	1-5/16" - 12 ORB	acero	4.95	125.7	2.20	55.9	44
1-1/4"	VEP10F10	1-1/4" - 11-1/2 NPTF	acero	5.43	137.9	2.73	69.3	55
	VEP10BF10	1-1/4" - 11 BSPP	acero	5.43	137.9	2.73	69.3	55
	VEP10OF10	1-5/8" - 12 ORB	acero	5.43	137.9	2.73	69.3	55
1-1/2"	VEP12F12	1-1/2" - 11-1/2 NPTF	acero	6.63	168.4	3.74	95.0	63
	VEP12BF12	1-1/2" - 11 BSPP	acero	6.63	168.4	3.74	95.0	63
	VEP12OF12	1-7/8" - 12 ORB	acero	6.63	168.4	3.74	95.0	63
2"	VEP16F16	2" - 11-1/2 NPTF	acero	11.08	281.4	5.70	144.8	89
	VEP16BF16	2" - 11 BSPP	acero	11.08	281.4	5.70	144.8	89
	VEP16OF16	2-1/2" - 12 ORB	acero	11.08	281.4	5.70	144.8	89

Coples Hidráulicos: Serie-VEP

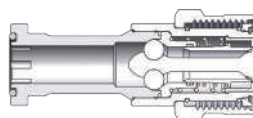

Serie-VEP Cople Código 62 Cabeza de Brida

Medida	Detalle			Medida		DE Máximo	
	# Parte	Roscas	Material	pulg	mm	pulg	mm
3/4"	6VEPFH6	3/4"	acero	4.95	125.63	2.20	55.88
1"	8VEPFH8	1"	acero	5.34	135.64	2.47	62.74
1-1/4"	10VEPFH10	1-1/4"	acero	6.26	158.88	2.70	68.58
1-1/2"	12VEPFH12	1-1/2"	acero	8.02	203.71	3.74	95.00

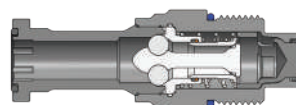

Serie-VEP Niple Código 62 Cabeza de Brida

Medida	Detalle			Medida		DE Máximo	
	# Parte	Roscas	Material	pulg	mm	pulg	mm
3/4"	VEP6FH6	3/4"	acero	5.70	144.78	1.98	50.29
1"	VEP8FH8	1"	acero	6.40	162.59	2.20	55.88
1-1/4"	VEP10FH10	1-1/4"	acero	7.30	185.42	2.73	69.34
1-1/2"	VEP12FH12	1-1/2"	acero	9.26	235.25	3.74	94.87

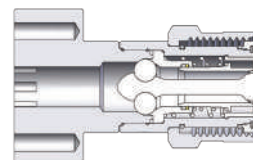

Serie-VEP Cople Código 62 con Brida

Medida	Detalle			Medida		DE Máximo	
	# Parte	Roscas	Material	pulg	mm	pulg	mm
3/4"	6VEFP6	3/4"	acero	4.45	112.93	3.02	76.71
1"	8VEFP8	1"	acero	5.34	135.64	3.44	87.38
1-1/4"	10VEFP10	1-1/4"	acero	5.56	141.10	4.03	102.29
1-1/2"	12VEFP12	1-1/2"	acero	6.52	165.71	4.76	120.93

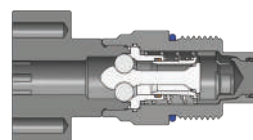

Serie-VEP Niple Código 62 con Brida

Medida	Detalle			Medida		DE Máximo	
	# Parte	Roscas	Material	pulg	mm	pulg	mm
3/4"	VEP6FP6	3/4"	acero	5.20	132.08	3.02	76.71
1"	VEP8FP8	1"	acero	6.40	162.59	3.44	87.38
1-1/4"	VEP10FP10	1-1/4"	acero	6.60	167.64	4.03	102.29
1-1/2"	VEP12FP12	1-1/2"	acero	7.76	197.15	4.76	120.93

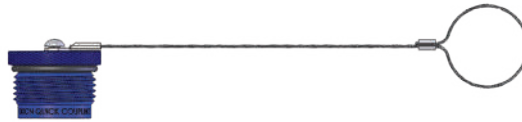

Medida	Serie-VEP Tapón rígido	
	# Parte	
1/4"	2VEPDP-A	
3/8"	3VEPDP-A	
1/2"	4VEPDP-A	
3/4"	6VEPDP-A	
1"	8VEPDP-A	
1-1/4"	10VEPDP-A	
1-1/2"	12VEPDP-A	
2"	16VEPDP-A	

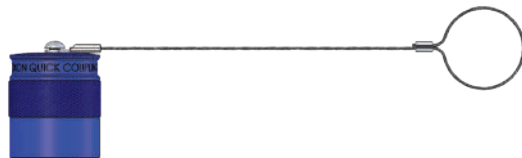

Medida	Serie-VEP Tapa rígido	
	# Parte	
1/4"	VEP2DC-A	
3/8"	VEP3DC-A	
1/2"	VEP4DC-A	
3/4"	VEP6DC-A	
1"	VEP8DC-A	
1-1/4"	VEP10DC-A	
1-1/2"	VEP12DC-A	
2"	VEP16DC-A	

NOTA: Tapas y tapones Serie-VEP son de aluminio con cable de acero

Tamaño	A	B
1/4"	0.64	0.49
3/8"	0.78	0.70
1/2"	0.96	0.74
3/4"	1.06	0.76
1"	1.18	0.94
1-1/4"	1.42	0.98
1-1/2"	2.25	1.25
2"	3.43	2.44

Serie-VEP Perfil

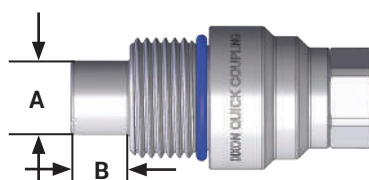

Información de Intercambio

- Stucchi Serie VEP/VEP-HD, DNP Serie FSI-BOP

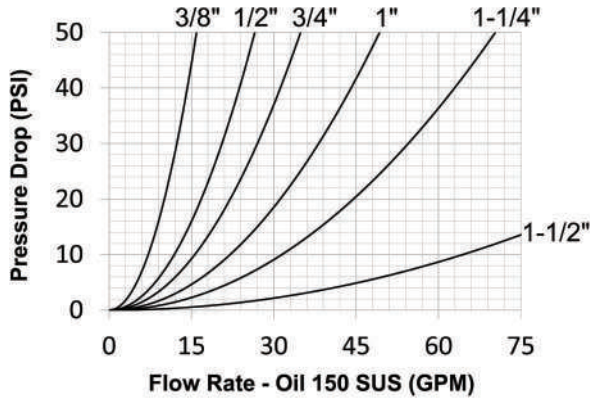

Componentes del Sello

- Los sellos del cople preventivo de reventón (BOP) son FKM para servicio severo.

Materiales

- Los componentes son maquinados con barras sólidas de acero
- Los anillos de retención y resortes maximizan la resistencia a la corrosión y extienden la vida del servicio
- Los componentes de acero son platinados con zinc niquelado que cumple con la norma ROHS
- Componentes con pintura roja en polvo y O-ring externo para fácil identificación del servicio BOP

- Los acoples BOP han sido probados con fuego y certificados por Lloyd a 1300°F (700°C) de acuerdo con API 16D. Certificado disponible bajo pedido.
- Utiliza las tapas y tapones VEP de la página 139.

Tabla de Valores de Presión

Serie VEP-BOP Intercambio																
Medida	Valor de Presión				Presión de Reventón						Max. Presión Conectado		Max. Presión Desconectado		Valor Flujo $\Delta P=21.75\text{PSI}$	
	Trabajo ISO		Impulso Max.		Conectado		Cople		Niple							
	PSI	Bar	PSI	Bar	PSI	Bar	PSI	Bar	PSI	Bar	PSI	Bar	PSI	Bar	GPM	L/min
3/8"	5,500	375	8,000	550	22,000	1,525	18,000	1,250	20,000	1,375	4,500	300	4,500	300	10.5	40
1/2"	5,500	375	8,000	550	22,000	1,525	18,000	1,250	20,000	1,375	4,500	300	4,500	300	17.5	66
3/4"	5,500	375	8,000	550	22,000	1,525	18,000	1,250	20,000	1,375	4,500	300	4,500	300	22.7	85
1"	5,500	375	7,500	525	22,000	1,525	14,500	1,000	20,000	1,375	3,625	250	3,625	250	32.5	123
1-1/4"	5,000	350	7,000	475	20,000	1,375	14,500	1,000	16,000	1,100	3,625	250	3,625	250	46.4	174
1-1/2"	5,000	300	5,800	400	18,000	1,250	12,000	8,325	14,500	1,000	3,000	200	3,000	200	95.0	360

Tamaño	A	B
3/8"	0.78	0.70
1/2"	0.96	0.74
3/4"	1.06	0.76
1"	1.18	0.94
1-1/4"	1.42	0.98
1-1/2"	2.25	1.25

Serie VEP-BOP Profile

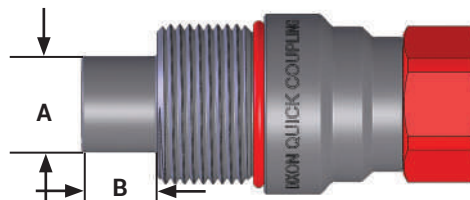

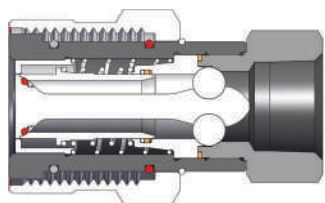

Medida	Serie VEP-BOP Cople de Seguridad Preventor de Reventón (Roscas Hembra)							
	Detalle			Medida		DE Máximo		Hex mm
	# Parte	Roscas	Material	pulg	mm	pulg	mm	
3/8"	3VEPF3-BOP	3/8" - 18 NPTF	acero	2.55	64.8	1.62	41.1	25
	3VEPF4-BOP	1/2" - 14 NPTF	acero	2.77	70.4	1.62	41.1	28
1/2"	4VEPF4-BOP	1/2" - 14 NPTF	acero	3.08	78.2	1.98	50.3	30
3/4"	6VEPF6-BOP	3/4" - 14 NPTF	acero	3.37	85.6	2.19	55.6	38
1"	8VEPF8-BOP	1" - 11-1/2 NPTF	acero	3.89	98.8	2.46	62.5	44
1-1/4"	10VEPF10-BOP	1-1/4" - 11-1/2 NPTF	acero	4.40	111.8	2.70	68.6	55
1-1/2"	12VEPF12-BOP	1-1/2" - 11-1/2 NPTF	acero	5.28	134.1	3.74	95.0	63

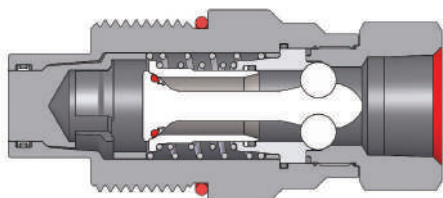

Medida	Serie VEP-BOP Niple de Seguridad Preventor de Reventón (Roscas Hembra)							
	Detalle			Medida		DE Máximo		Hex mm
	# Parte	Roscas	Material	pulg	mm	pulg	mm	
3/8"	VEP3F3-BOP	3/8" - 18 NPTF	acero	3.28	83.3	1.48	37.6	25
	VEP3F4-BOP	1/2" - 14 NPTF	acero	3.50	88.9	1.48	37.6	28
1/2"	VEP4F4-BOP	1/2" - 14 NPTF	acero	3.87	98.3	1.86	47.2	30
3/4"	VEP6F6-BOP	3/4" - 14 NPTF	acero	4.12	104.6	1.98	50.3	38
1"	VEP8F8-BOP	1" - 11-1/2 NPTF	acero	4.95	125.7	2.20	55.9	44
1-1/4"	VEP10F10-BOP	1-1/4" - 11-1/2 NPTF	acero	5.43	137.9	2.73	69.3	55
1-1/2"	VEP12F12-BOP	1-1/2" - 11-1/2 NPTF	acero	6.63	164.4	3.74	95.0	63

Información de Intercambio

- Eaton/Aeroquip Serie-5100, Parker Serie-6100
- Snap-Tite 78-Series, Faster Series-FB, Safeway S51-Series

Materiales

- Los componentes son maquinados con barras sólidas de acero o latón.
- Los anillos de retención y resortes de acero inoxidable maximizan la resistencia a la corrosión y extienden la vida del servicio.
- Los componentes de acero son platinados con cromo trivalente y cumplen con la norma ROHS
- Tuerca mariposa robusta para conexión y desconexión roscada
- Para modelos de acero, la válvula del cople y la válvula del niple están contruidos de latón.

Componentes del Sello

- Sellos de Nitrilo (Buna-N) estándar brindan un rango de temperatura de **-40°F a 250°F (-40°C a 121°C)**
- Los acoples tienen un anillo TPC-ET en la manga de la válvula principal para extender su vida de servicio
- La válvula principal del cople tiene un sello adherido para mejorar la integridad del sellado durante la conexión y desconexión presurizada
- El sello de la válvula del niple está crimpado para mejorar la integridad del sello y prolongar la vida del servicio
- El O-ring externo en el niple indica la conexión completa y actúa como un escudo cuando está conectado
- Un O-ring en el cuerpo del cople se une al niple para su sellado de soporte secundario.



Tabla de Valores de Presión

Medida	Serie-W Intercambio Wingstyle(Conectado)			
	Cople/Niple			
	Trabajo Máximo		Reventón	
	PSI	Bar	PSI	Bar
1/4"	3,000	207	14,000	965
3/8"	3,000	207	13,000	897
3/4"	3,000	207	13,000	897
1"	4,000	276	16,000	1,103
1-1/4"	3,000	207	12,000	828
1-1/2"	2,500	172	10,000	690

Especificaciones Técnicas

Medida	Estándar Intercambio				Parámetros Funcionales				
	Ejército USA	Gobierno USA	Estántar Int	Estándar ANSI/NFPA	Mecanismo Seguridad	Inclusión Aire	Pérdida Fluido	Vacío pulg HG	Flujo ΔP = 32 PSI
1/4"					roscado	0.03cc	0.01cc	27.4	6 GPM
3/8"					roscado	0.05cc	0.06cc	27.4	15 GPM
3/4"	-	-	-	-	roscado	0.34cc	0.26cc	27.4	31 GPM
1"	-	-	-	-	roscado	0.50cc	0.35cc	27.4	52 GPM
1-1/4"	-	-	-	-	roscado	0.68cc	0.70cc	27.4	85 GPM
1-1/2"	-	-	-	-	roscado	0.60cc	0.94cc	27.4	110 GPM

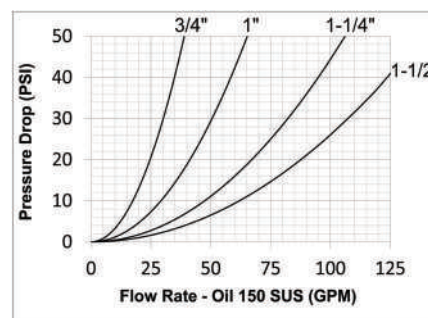
! Aunque los acoples estilo wingstyle son para conectarse y desconectarse mientras están bajo presión, se recomienda que el suministro hidráulico sea desenergizado durante la conexión por seguridad del operador. Si no es posible desenergizar el circuito, los operadores deben estar seguros que ninguna unión o herramienta los puede poner en riesgo, una vez que el poder hidráulico se aplique durante el proceso de conexión.

Los acoples Serie-W no son recomendados para aplicaciones de impulso hidráulico continuo.

Wingstyle Socket Features

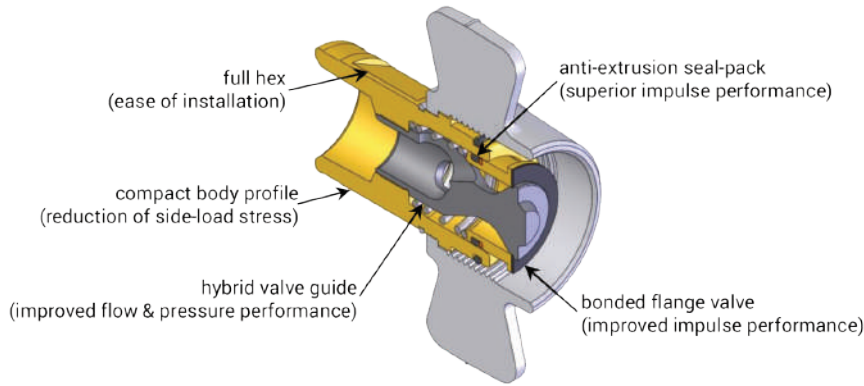

Wingstyle Plug Features

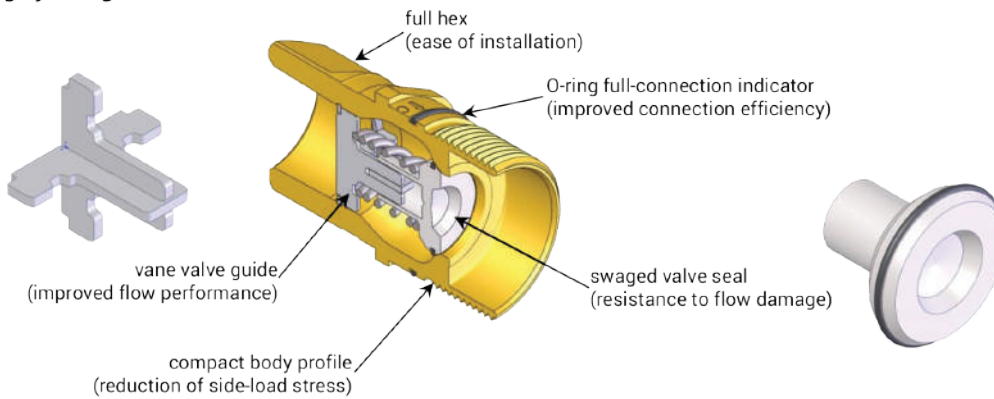

Hybrid valve design increases flow and pressure performance.



Tamaño	A	B
1/4"	0.93	0.94
3/8"	1.12	1.06
3/4"	1.49	0.95
1"	1.85	1.49
1-1/4"	2.12	1.62
1-1/2"	2.47	1.91

Perfil Serie-W

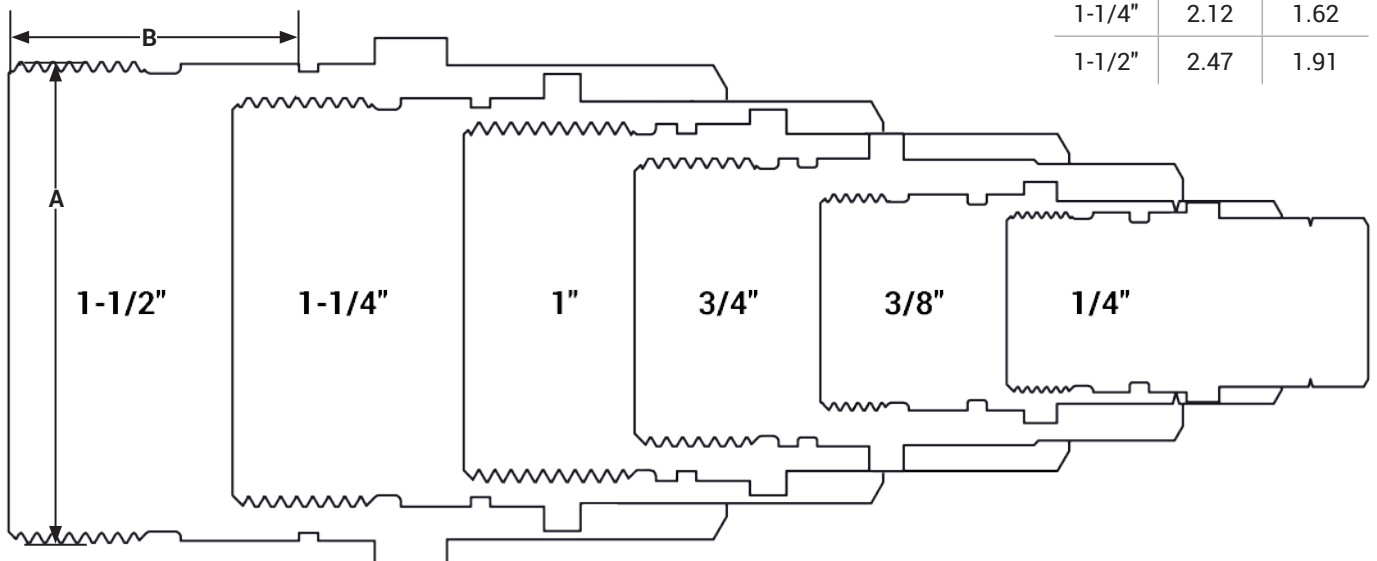

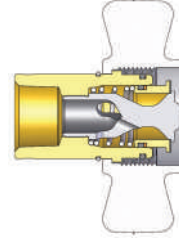

Serie-W Cople Intercambio Wingstyle (Roscas Hembra)

Medida	Detalle			Medida		DE Máximo		Cara pulg
	# Parte	Roscas	Material	pulg	mm	pulg	mm	
1/4"	2WF1-B	1/8" - 27 NPTF	latón	2.00	50.8	3.02	76.7	5/8"
3/8"	3WF2-B	1/4" - 18 NPTF	latón	2.33	59.1	3.46	87.8	13/16"
	3WF3-B	3/8" - 18 NPTF	latón	2.33	59.1	3.46	87.8	13/16"
3/4"	6WF4-B	1/2" - 14 NPTF	latón	2.73	69.3	4.09	103.9	1-5/32"
	6WBF4-B	1/2" - 14 BSPP	latón	2.73	69.3	4.09	103.9	1-5/32"
	6WF6-B	3/4" - 14 NPTF	latón	2.73	69.3	4.09	103.9	1-5/32"
	6WBF6-B	3/4" - 14 BSPP	latón	2.73	69.3	4.09	103.9	1-5/32"
1"	8WF8-B	1" - 11-1/2 NPTF	latón	3.33	84.6	4.49	114.0	1-15/32"
	8WF8	1" - 11-1/2 NPTF	acero	3.33	84.6	4.49	114.0	1-15/32"
	8WBF8-B	1" - 11 BSPP	latón	3.33	84.6	4.49	114.0	1-15/32"
1-1/4"	10WF10-B	1-1/4" - 11-1/2 NPTF	latón	3.64	92.5	5.27	133.9	1-25/32"
	10WBF10-B	1-1/4" - 11 BSPP	latón	3.64	92.5	5.27	133.9	1-25/32"
1-1/2"	12WF12-B	1-1/2" - 11-1/2 NPTF	latón	3.67	93.2	5.35	135.9	2-7/64"
	12WBF12-B	1-1/2" - 11 BSPP	latón	4.08	103.6	5.35	135.9	2-7/64"

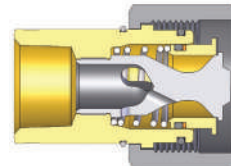
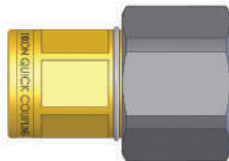

Serie-W Cople Intercambio Wingstyle Tuerca Hex (Roscas Hembra)

Medida	Detalle			Medida		DE Máximo		Hex pulg
	# Parte	Roscas	Material	pulg	mm	pulg	mm	
1/4"	2WF1-B-HN	1/8" - 27 NPTF	latón	2.00	50.8	3.00	76.2	0.63"
3/8"	3WF2-B-HN	1/4" - 18 NPTF	latón	2.33	59.2	3.45	87.6	0.81"
	3WF3-B-HN	3/8" - 18 NPTF	latón	2.33	59.2	3.45	87.6	0.81"
3/4"	6WF4-B-HN	1/2" - 14 NPTF	latón	2.73	69.3	1.92	48.8	1-5/32"
	6WBF4-B-HN	1/2" - 14 BSPP	latón	2.73	69.3	1.92	48.8	1-5/32"
	6WF6-B-HN	3/4" - 14 NPTF	latón	2.73	69.3	1.92	48.8	1-5/32"
	6WBF6-B-HN	3/4" - 14 BSPP	latón	2.73	69.3	1.92	48.8	1-5/32"
1"	8WF8-B-HN	1" - 11-1/2 NPTF	latón	3.33	84.6	2.33	59.2	1-15/32"
	8WF8-HN	1" - 11-1/2 NPTF	acero	3.33	84.6	2.33	59.2	1-15/32"
	8WBF8-B-HN	1" - 11 BSPP	latón	3.33	84.6	2.33	59.2	1-15/32"
1-1/4"	10WF10-B-HN	1-1/4" - 11-1/2 NPTF	latón	3.64	92.5	2.75	69.9	1-25/32"
	10WBF10-B-HN	1-1/4" - 11 BSPP	latón	3.64	92.5	2.75	69.9	1-25/32"
1-1/2"	12WF12-B-HN	1-1/2" - 11-1/2 NPTF	latón	3.67	93.2	3.01	76.5	2-7/64"
	12WBF12-B-HN	1-1/2" - 11 BSPP	latón	3.67	93.2	3.01	76.5	2-7/64"

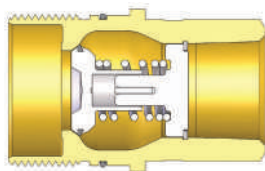

Medida	Serie-W Niple Intercambio Wingstyle (Roscas Hembra)							
	Detalle			Medida		DE Máximo		Hex pulg
	# Parte	Roscas	Material	pulg	mm	pulg	mm	
1/4"	W2F1-B	1/8"-27 NPTF	latón	1.88	47.8	1.04	26.3	15/16"
3/8"	W3F2-B	1/4"-18 NPTF	latón	2.30	58.4	1.25	31.8	1-1/4"
	W3F3-B	3/8"-18 NPTF	latón	2.40	61.0	1.25	31.8	1-1/4"
3/4"	W6F4-B	1/2" - 14 NPTF	latón	2.85	72.4	1.75	44.5	1-5/16"
	W6BF4-B	1/2" - 14 BSPP	latón	2.85	72.4	1.75	44.5	1-5/16"
	W6F6-B	3/4" - 14 NPTF	latón	2.85	72.4	1.75	44.5	1-5/16"
	W6BF6-B	3/4" - 14 BSPP	latón	2.85	72.4	1.75	44.5	1-5/16"
1"	W8F8-B	1" - 11-1/2 NPTF	latón	3.15	80.0	2.00	50.8	1-9/16"
	W8F8	1" - 11-1/2 NPTF	acero	3.15	80.0	2.00	50.8	1-9/16"
	W8BF8-B	1" - 11 BSPP	latón	3.15	80.0	2.00	50.8	1-9/16"
1-1/4"	W10F10-B	1-1/4" - 11-1/2 NPTF	latón	3.39	86.1	2.37	60.2	1-15/16"
	W10BF10-B	1-1/4" - 11 BSPP	latón	3.39	86.1	2.37	60.2	1-15/16"
1-1/2"	W12F12-B	1-1/2" - 11-1/2 NPTF	latón	3.74	95.0	2.73	69.3	2-1/4"
	W12BF12-B	1-1/2" - 11 BSPP	latón	3.74	95.0	2.73	69.3	2-1/4"

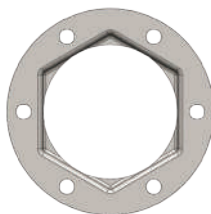

Niple no incluido con brida

Medida	Serie-W Niple Intercambio Wingstyle para Brida		
	Detalle		
	# Parte	Agujero	Material
3/4"	W6-BMF	0.201"	acero
1"	W8-BMF	0.201"	acero
1-1/4"	W10-BMF	0.201"	acero
1-1/2"	W12-BMF	0.201"	acero

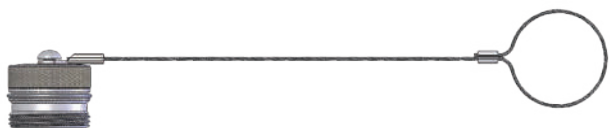

Medida	Serie-W Tapón Rígido para Cople Intercambio Wingstyle		
	Detalle		
	# Parte	Cuerda	Cuerpo
1/4"	2WDP	cable de acero	acero
3/8"	3WDP	cable de acero	acero
3/4"	6WDP	cable de acero	acero
1"	8WDP	cable de acero	acero
1-1/4"	10WDP	cable de acero	acero
1-1/2"	12WDP	cable de acero	acero

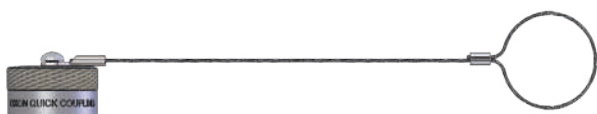

Medida	Serie-W Tapón Rígido para Niple Intercambio Wingstyle		
	Detalle		
	# Parte	Cuerda	Cuerpo
1/4"	W2DC	cable de acero	acero
3/8"	W3DC	cable de acero	acero
3/4"	W6DC	cable de acero	acero
1"	W8DC	cable de acero	acero
1-1/4"	W10DC	cable de acero	acero
1-1/2"	W12DC	cable de acero	acero

Medida	Serie-W Kit de Reparación de Cople Intercambio Wingstyle			
	Detalle			Contenido de Kits de Reparación (para un cople)
	# Parte	Estilo de Cople	Material de Sello	
3/4"	6W-RKIT-V2	Todos	nitrilo	Repuesto de Válvula, O-rings y Hytrel
1"	8W-RKIT-V2	Todos	nitrilo	Repuesto de Válvula, O-rings y Hytrel
1-1/4"	10W-RKIT-V2	Todos	nitrilo	Repuesto de Válvula, O-rings y Hytrel
1-1/2"	12W-RKIT-V2	Todos	nitrilo	Repuesto de Válvula, O-rings y Hytrel

Medida	Serie-W Kit de Reparación de Niple Intercambio Wingstyle			
	Detalle			Contenido de Kits de Reparación (para un cople)
	# Parte	Estilo de Cople	Material de Sello	
3/4"	W6-RKIT-V2	Todos	nitrilo	Ensamble de válvula y O-ring
1"	W8-RKIT-V2	Todos	nitrilo	Ensamble de válvula y O-ring
1-1/4"	W10-RKIT-V2	Todos	nitrilo	Ensamble de válvula y O-ring
1-1/2"	W12-RKIT-V2	Todos	nitrilo	Ensamble de válvula y O-ring

Información de Intercambio

- Snap-Tite Serie-75, Hydraulics Inc. Series-5TV, DNP VFF-HD, Stucchi VOF, FASTER OGV, Eaton FD85, Holmbury LC

Materiales

- Los componentes son maquinados con barras sólidas de acero o acero inoxidable 316.
- Anillos de retención y resortes de acero inoxidable maximizan la resistencia a la corrosión y extienden la vida del servicio.
- Los componentes de acero están platinados con cromo-sobre-níquel ROHS para resistencia a la corrosión
- Tuerca mariposa robusta para conexión roscada
- Las roscas de los nipples de acero inoxidable 316 están cubiertas para prevenir daños durante la conexión y desconexión

Componentes del Sello

- Sellos de Nitrilo (Buna-N) estándar brindan un rango de temperatura de **-40°F a 250°F (-40°C a 121°C)**
- Todos los acoples incorporan un anillo PTFE anti-extrusión para proteger los componentes del sello de daños por impulso dinámico.



Tabla de Valores de Presión

Medida	Serie-WS Wingstyle Trabajo Pesado (Conectado)							
	Cople/Niple Acero				Cople/Niple Acero A.I. 316			
	Trabajo Máximo		Reventón		Trabajo Máximo		Reventón	
	PSI	Bar	PSI	Bar	PSI	Bar	PSI	Bar
3/4"	5,000	345	32,800	2,200	3,000	200	20,000	1,400
1"	5,000	345	25,100	1,700	3,000	200	20,000	1,400
1-1/4"	5,000	345	25,100	1,700	3,000	200	15,000	1,000
1-1/2"	5,000	345	20,000	1,400	3,000	200	15,000	1,000
2"	5,000	345	15,000	1,000	3,000	200	15,000	1,000

Especificaciones Técnicas

Medida	Estándar Intercambio				Parámetros Funcionales				
	Ejército USA	Gobierno USA	Estántar Int	Estándar ANSI/NFPA	Mecanismo Seguridad	Inclusión Aire	Pérdida Fluido	Vacío pulg HG	Flujo ΔP = 30 PSI
3/4"	-	-	-	-	roscado	10cc	10cc	27.4	35 GPM
1"	-	-	-	-	roscado	23cc	15cc	27.4	65 GPM
1-1/4"	-	-	-	-	roscado	50cc	30cc	27.4	105 GPM
1-1/2"	-	-	-	-	roscado	100cc	60cc	27.4	160 GPM
2"					roscado	200cc	135cc	27.4	270 GPM

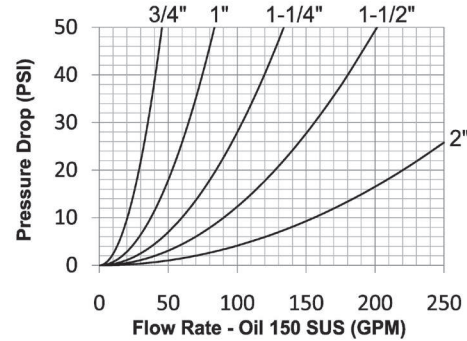
Opciones Disponibles

Medida	Opciones de Sellado Estándar					Standard Coupling Options		
	FKM	EPDM	Mil-Nitrilo	Nitrilo Combustible	Silicón	Wrench Flats	View Port	Oxy-Clean
	Pre	Pre	Pre	Pre	Pre	Suf	Suf	Suf
3/4"	F-	P-	M-	JF-	S-	-WF	-VP	-C1
1"	F-	P-	M-	JF-	S-	-WF	-VP	-C1
1-1/4"	F-	P-	M-	JF-	S-	-WF	-VP	-C1
1-1/2"	F-	P-	M-	JF-	S-	-WF	-VP	-C1
2"	F-	P-	M-	JF-	S-	-WF	-VP	-C1

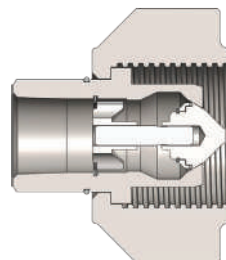

Medida	Serie-SW Cople Wingstyle Trabajo Pesado (Roscas Hembra)							
	Detalle			Medida		DE Máximo		Hex pulg
	# Parte	Roscas	Material	pulg	mm	pulg	mm	
3/4"	6WSF4	1/2" - 14 NPTF	acero	2.76	70.1	3.31	82.0	-
	6WSF6	3/4" - 14 NPTF	acero	2.76	70.1	3.31	82.0	-
	6WSF6-SS	3/4" - 14 NPTF	A.I. 316	2.76	70.1	3.31	82.0	-
	6WSBF6	3/4" - 14 BSPP	acero	2.76	70.1	3.31	82.0	-
	6WSBF6-SS	3/4" - 14 BSPP	A.I. 316	2.76	70.1	3.31	82.0	-
	6WSOF6	1-1/16" - 12 ORB	acero	2.76	70.1	3.31	82.0	-
1"	8WSF8	1" - 11-1/2 NPTF	acero	3.45	87.6	4.10	101.6	-
	8WSF8-SS	1" - 11-1/2 NPTF	A.I. 316	3.45	87.6	4.10	101.6	-
	8WSBF8	1" - 11 BSPP	acero	3.45	87.6	4.10	101.6	-
	8WSBF8-SS	1" - 11 BSPP	A.I. 316	3.45	87.6	4.10	101.6	-
	8WSOF8	1-5/16" - 12 ORB	acero	3.45	87.6	4.10	101.6	-
1-1/4"	10WSF10	1-1/4" - 11-1/2 NPTF	acero	4.40	111.8	4.78	118.1	-
	10WSF10-SS	1-1/4" - 11-1/2 NPTF	A.I. 316	4.40	111.8	4.78	118.1	-
	10WSBF10	1-1/4" - 11 BSPP	acero	4.40	111.8	4.78	118.1	-
	10WSBF10-SS	1-1/4" - 11 BSPP	A.I. 316	4.40	111.8	4.78	118.1	-
	10WSOF10	1-5/8" - 12 ORB	acero	4.40	111.8	4.78	118.1	-
1-1/2"	12WSF12	1-1/2" - 11-1/2 NPTF	acero	5.13	130.3	5.68	137.9	-
	12WSF12-SS	1-1/2" - 11-1/2 NPTF	A.I. 316	5.13	130.3	5.68	137.9	-
	12WSBF12	1-1/2" - 11 BSPP	acero	5.13	130.3	5.68	137.9	-
	12WSBF12-SS	1-1/2" - 11 BSPP	A.I. 316	5.13	130.3	5.68	137.9	-
	12WSOF12	1-7/8" - 12 ORB	acero	5.13	130.3	5.68	137.9	-
2"	16WSF16	2" - 11-1/2 NPTF	acero	6.09	154.7	6.90	170.9	-
	16WSF16-SS	2" - 11-1/2 NPTF	A.I. 316	6.09	154.7	6.90	170.9	-
	16WSBF16	2" - 11 BSPP	acero	6.09	154.7	6.90	170.9	-
	16WSBF16-SS	2" - 11 BSPP	A.I. 316	6.09	154.7	6.90	170.9	-
	16WSOF16	2-1/2" - 12 ORB	acero	6.09	154.7	6.90	170.9	-

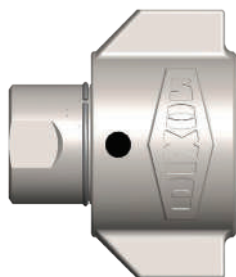

Cople WS con puerto de inspección



Cople WS con superficies para llave

Nota: Las superficies para llave pueden mostrar desempeño de presión reducido.

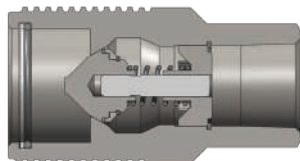

Medida	Serie-WS Niple Wingstyle Trabajo Pesado (Roscas Hembra)							
	Detalle			Medida		DE Máximo		Hex pulg
	# Parte	Roscas	Material	pulg	mm	pulg	mm	
3/4"	WS6F4	1/2" - 14 NPTF	acero	3.27	83.1	1.74	44.2	-
	WS6F6	3/4" - 14 NPTF	acero	3.27	83.1	1.74	44.2	-
	WS6F6-SS	3/4" - 14 NPTF	A.I. 316	3.27	83.1	1.74	44.2	-
	WS6BF6	3/4" - 14 BSPP	acero	3.27	83.1	1.74	44.2	-
	WS6BF6-SS	3/4" - 14 BSPP	A.I. 316	3.27	83.1	1.74	44.2	-
	WS6OF6	1-1/16" - 12 ORB	acero	3.27	83.1	1.74	44.2	-
1"	WS8F8	1" - 11-1/2 NPTF	acero	4.18	106.2	2.25	57.2	-
	WS8F8-SS	1" - 11-1/2 NPTF	A.I. 316	4.18	106.2	2.25	57.2	-
	WS8BF8	1" - 11 BSPP	acero	4.18	106.2	2.25	57.2	-
	WS8BF8-SS	1" - 11 BSPP	A.I. 316	4.18	106.2	2.25	57.2	-
	WS8OF8	1-5/16" - 12 ORB	acero	4.18	106.2	2.25	57.2	-
1-1/4"	WS10F10	1-1/4" - 11-1/2 NPTF	acero	5.38	136.7	2.63	66.8	-
	WS10F10-SS	1-1/4" - 11-1/2 NPTF	A.I. 316	5.38	136.7	2.63	66.8	-
	WS10BF10	1-1/4" - 11 BSPP	acero	5.38	136.7	2.63	66.8	-
	WS10BF10-SS	1-1/4" - 11 BSPP	A.I. 316	5.38	136.7	2.63	66.8	-
	WS10OF10	1-5/8" - 12 ORB	acero	5.38	136.7	2.63	66.8	-
1-1/2"	WS12F12	1-1/2" - 11-1/2 NPTF	acero	5.98	151.9	3.25	82.6	-
	WS12F12-SS	1-1/2" - 11-1/2 NPTF	A.I. 316	5.98	151.9	3.25	82.6	-
	WS12BF12	1-1/2" - 11 BSPP	acero	5.98	151.9	3.25	82.6	-
	WS12BF12-SS	1-1/2" - 11 BSPP	A.I. 316	5.98	151.9	3.25	82.6	-
	WS12OF12	1-7/8" - 12 ORB	acero	5.98	151.9	3.25	82.6	-
2"	WS16F16	2" - 11-1/2 NPTF	acero	7.05	179.1	4.00	101.6	-
	WS16F16-SS	2" - 11-1/2 NPTF	A.I. 316	7.05	179.1	4.00	101.6	-
	WS16BF16	2" - 11 BSPP	acero	7.05	179.1	4.00	101.6	-
	WS16BF16-SS	2" - 11 BSPP	A.I. 316	7.05	179.1	4.00	101.6	-
	WS16OF16	2-1/2" - 12 ORB	acero	7.05	179.1	4.00	101.6	-

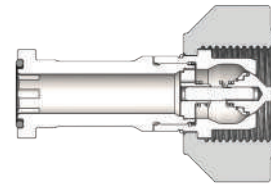
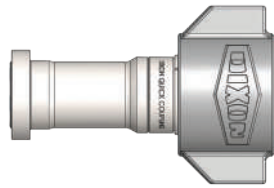

Serie-WS Cople Código 62 Wingstyle Trabajo Pesado con Brida

Medida	Detalle			Medida		DE Máximo	
	# Parte	Medida	Material	pulg	mm	pulg	mm
3/4"	6WSFH6	3/4" código 62 con brida	acero	4.79	121.67	3.31	84.07
1"	8WSFH8	1" código 62 con brida	acero	6.98	177.29	4.10	104.14
1-1/4"	10WSFH10	1-1/4" código 62 con brida	acero	8.27	210.06	4.78	121.41
1-1/2"	12WSFH12	1-1/2" código 62 con brida	acero	9.30	236.14	5.68	144.27
2"	16WSFH16	2" código 62 con brida	acero	10.82	274.93	6.90	175.26

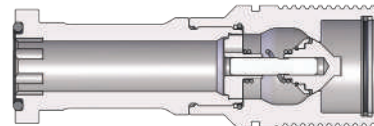

Serie-WS Niple Código 62 Wingstyle Trabajo Pesado con Brida

Medida	Detalle			Medida		DE Máximo	
	# Parte	Medida	Material	pulg	mm	pulg	mm
3/4"	WS6FH6	3/4" código 62 con brida	acero	5.23	132.84	1.74	44.20
1"	WS8FH8	1" código 62 con brida	acero	7.84	199.14	2.25	57.15
1-1/4"	WS10FH10	1-1/4" código 62 con brida	acero	9.39	238.61	2.63	66.68
1-1/2"	WS12FH12	1-1/2" código 62 con brida	acero	10.15	257.76	3.25	82.55
2"	WS16FH16	2" código 62 con brida	acero	11.78	299.31	4.00	101.60

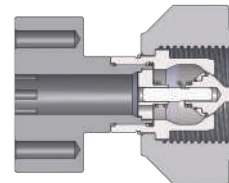

Serie-WS Cople Código 62 Wingstyle Trabajo Pesado con Brida

Medida	Detalle			Medida		DE Máximo	
	# Parte	Medida	Material	pulg	mm	pulg	mm
3/4"	6WSFP6	3/4" código 62 con brida	acero	4.04	102.62	3.31	84.07
1"	8WSFP8	1" código 62 con brida	acero	5.48	139.19	4.10	104.14
1-1/4"	10WSFP10	1-1/4" código 62 con brida	acero	6.79	172.47	4.78	121.41
1-1/2"	12WSFP12	1-1/2" código 62 con brida	acero	8.40	213.31	5.68	144.27
2"	16WSFP16	2" código 62 con brida	acero	9.40	238.73	6.90	175.26

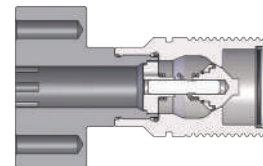
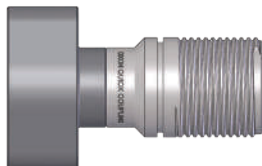

Serie-WS Niple Código 62 Wingstyle Trabajo Pesado con Brida

Medida	Detalle			Medida		DE Máximo	
	# Parte	Medida	Material	pulg	mm	pulg	mm
3/4"	WS6FP6	3/4" código 62 con brida	acero	4.48	113.79	3.02	76.71
1"	WS8FP8	1" código 62 con brida	acero	6.34	161.04	3.44	87.40
1-1/4"	WS10FP10	1-1/4" código 62 con brida	acero	7.91	201.02	4.03	102.41
1-1/2"	WS12FP12	1-1/2" código 62 con brida	acero	9.25	234.90	4.76	120.90
2"	WS16FP16	2" código 62 con brida	acero	10.36	263.12	5.67	144.12



Medida	Serie-WS Tapón Rígido para Cople Coupler		
	Detalle		
	# Parte	Cuerda	Cuerpo
3/4"	6WSDP-A	cable de acero	aluminio
1"	8WSDP-A	cable de acero	aluminio
1-1/4"	10WSDP-A	cable de acero	aluminio
1-1/2"	12WSDP-A	cable de acero	aluminio
2"	16WSDP-A	cable de acero	aluminio



Medida	Serie-WS Tapa Rígida para Niple		
	Detalle		
	# Parte	Cuerda	Cuerpo
3/4"	WS6DC-A	cable de acero	aluminio
1"	WS8DC-A	cable de acero	aluminio
1-1/4"	WS10DC-A	cable de acero	aluminio
1-1/2"	WS12DC-A	cable de acero	aluminio
2"	WS16DC-A	cable de acero	aluminio

Coples Hidráulicos: Serie-WS

Medida	Serie-WS Kit de Sellos para Cople Intercambio Wingstyle Trabajo Pesado			
	Detalle			Contenido Kit de Sellos
	# Parte	Estilo de Cople	Material de Sello	
3/4"	6WS-SKIT	Todos	nitrilo	Sellos de Válvula/Cuerpo y Anillos de Retención
1"	8WS-SKIT	Todos	nitrilo	Sellos de Válvula/Cuerpo y Anillos de Retención
1-1/4"	10WS-SKIT	Todos	nitrilo	Sellos de Válvula/Cuerpo y Anillos de Retención
1-1/2"	12WS-SKIT	Todos	nitrilo	Sellos de Válvula/Cuerpo y Anillos de Retención
2"	16WS-SKIT	Todos	nitrilo	Sellos de Válvula/Cuerpo y Anillos de Retención

Medida	Serie-WS Kit de Sellos para Cople Intercambio Wingstyle BOP			
	Detalle			Contenido Kit de Sellos
	# Parte	Estilo de Cople	Material de Sello	
3/4"	6BOP-SKIT	Todos	FR FKM	Sellos de Válvula/Cuerpo y Anillos de Retención
1"	8BOP-SKIT	Todos	FR FKM	Sellos de Válvula/Cuerpo y Anillos de Retención
1-1/4"	10BOP-SKIT	Todos	FR FKM	Sellos de Válvula/Cuerpo y Anillos de Retención
1-1/2"	12BOP-SKIT	Todos	FR FKM	Sellos de Válvula/Cuerpo y Anillos de Retención
2"	16BOP-SKIT	Todos	FR FKM	Sellos de Válvula/Cuerpo y Anillos de Retención

Medida	Serie-WS Kit de Reparación de Coples Intercambio Wingstyle Trabajo Pesado			
	Detalle			Contenido de Kits de Reparación (para un solo cople o niple)
	# Parte	Estilo de Cople	Material de Sello	
3/4"	6WS-RKIT	Todos	nitrilo	Ensamble de válvula O-ring y PTFE B.U.
1"	8WS-RKIT	Todos	nitrilo	Ensamble de válvula O-ring y PTFE B.U.
1-1/4"	10WS-RKIT	Todos	nitrilo	Ensamble de válvula O-ring y PTFE B.U.
1-1/2"	12WS-RKIT	Todos	nitrilo	Ensamble de válvula O-ring y PTFE B.U.
2"	16WS-RKIT	Todos	nitrilo	Ensamble de válvula O-ring y PTFE B.U.

Información de Intercambio

- Snap-Tite Serie-75, DNP VFF-HD Serie-BOP

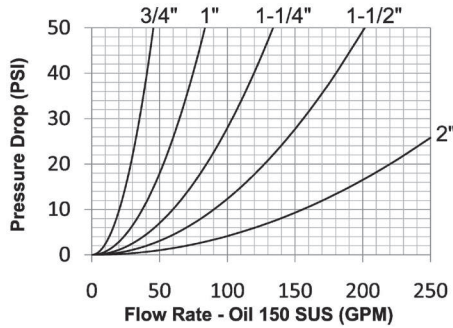

Componentes del Sello

- Los acoples para prevención de reventón (BOP) tiene sellos FKM para servicio severo.
- El anillo anti-extrusión PTFE protege el sello de la válvula principal de daños por la presión de impulso dinámico.

Materiales

- Los componentes son maquinados con barras sólidas de acero o acero inoxidable 316.
- Anillos de retención y resortes de acero inoxidable maximizan la resistencia a la corrosión y extienden la vida del servicio.
- Los componentes de acero están platinados con cromo-sobre-níquel ROHS para resistencia a la corrosión
- Tuerca mariposa robusta para conexión roscada
- Las roscas de los nipples de acero inoxidable 316 están cubiertas para prevenir daños durante la conexión y desconexión
- Tuerca del cople y nipple externo pintados con polvo rojo para fácil identificación de servicio BOP

- Los coples BOP han sido probados con fuego y están certificados por Lloyd a 1300°F (700°C) de acuerdo con API 16D.
- Utilice tapas y tapones WS de la página 151

Tabla de Valores de Presión

Medida	Serie WS-BOP Wingstyle Preventor de Reventón Trabajo Pesado							
	Cople/Niple Acero				Cople/Niple A.I. 316			
	Trabajo Máximo		Reventón		Trabajo Máximo		Reventón	
	PSI	Bar	PSI	Bar	PSI	Bar	PSI	Bar
3/4"	5,000	345	32,800	2,200	5,000	345	20,000	1,400
1"	5,000	345	25,100	1,700	5,000	345	20,000	1,400
1-1/4"	5,000	345	25,100	1,700	5,000	345	15,000	1,000
1-1/2"	5,000	345	20,000	1,400	5,000	345	15,000	1,000
2"	5,000	345	15,000	1,000	5,000	345	15,000	1,000

Especificaciones Técnicas

Medida	Parámetros Funcionales					Lloyd's Test Pressure
	Mecanismo Seguridad	Inclusión Aire	Pérdida Fluido	Vacío pulg HG	Flujo ΔP = 30 PSI	PSI
3/4"	roscado	10cc	10cc	27.4	35 GPM	5,000
1"	roscado	23cc	15cc	27.4	65 GPM	5,000
1-1/4"	roscado	50cc	30cc	27.4	105 GPM	5,000
1-1/2"	roscado	100cc	60cc	27.4	160 GPM	5,000
2"	roscado	200cc	135cc	27.4	270 GPM	5,000

Tamaño	A	B
3/4"	1.74	1.53
1"	2.25	1.90
1-1/4"	2.63	2.28
1-1/2"	3.25	2.80
2"	4.00	3.64

Perfil Serie WS-BOP

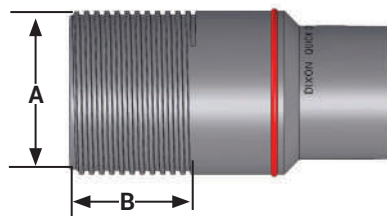

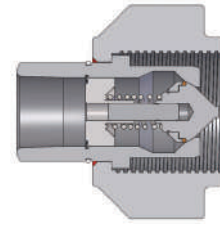

Medida	Serie WS-BOP Cople de Seguridad Previsor de Reventón (Roscas Hembra)							
	Detalle			Medida		DE Máximo		Hex pulg
	# Parte	Roscas	Material	pulg	mm	pulg	mm	
3/4"	6WSF4-BOP	1/2" - 14 NPTF	acero	2.76	70.1	3.31	82.0	-
	6WSF6-BOP	3/4" - 14 NPTF	acero	2.76	70.1	3.31	82.0	-
	6WSF6-SS-BOP	3/4" - 14 NPTF	A.I. 316	2.76	70.1	3.31	82.0	-
1"	8WSF8-BOP	1" - 11-1/2 NPTF	acero	3.45	87.6	4.10	101.6	-
	8WSF8-SS-BOP	1" - 11-1/2 NPTF	A.I. 316	3.45	87.6	4.10	101.6	-
1-1/4"	10WSF10-BOP	1-1/4" - 11-1/2 NPTF	acero	4.40	111.8	4.78	118.1	-
	10WSF10-SS-BOP	1-1/4" - 11-1/2 NPTF	A.I. 316	4.40	111.8	4.78	118.1	-
1-1/2"	12WSF12-BOP	1-1/2" - 11-1/2 NPTF	acero	5.13	130.3	5.68	137.9	-
	12WSF12-SS-BOP	1-1/2" - 11-1/2 NPTF	A.I. 316	5.13	130.3	5.68	137.9	-
2"	16WSF16-BOP	2" - 11-1/2 NPTF	acero	6.09	154.7	6.90	170.9	-
	16WSF16-SS-BOP	2" - 11-1/2 NPTF	A.I. 316	6.09	154.7	6.90	170.9	-

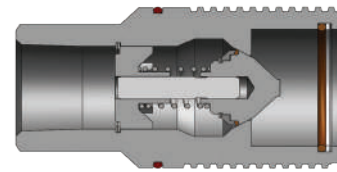

Medida	Serie WS-BOP Niple de Seguridad Previsor de Reventón (Roscas Hembra)							
	Detalle			Medida		DE Máximo		Hex pulg
	# Parte	Roscas	Material	pulg	mm	pulg	mm	
3/4"	WS6F4-BOP	1/2" - 14 NPTF	acero	3.27	83.1	1.74	44.2	-
	WS6F6-BOP	3/4" - 14 NPTF	acero	3.27	83.1	1.74	44.2	-
	WS6F6-SS-BOP	3/4" - 14 NPTF	A.I. 316	3.27	83.1	1.74	44.2	-
1"	WS8F8-BOP	1" - 11-1/2 NPTF	acero	4.18	106.2	2.25	57.2	-
	WS8F8-SS-BOP	1" - 11-1/2 NPTF	A.I. 316	4.18	106.2	2.25	57.2	-
1-1/4"	WS10F10-BOP	1-1/4" - 11-1/2 NPTF	acero	5.38	136.7	2.63	66.8	-
	WS10F10-SS-BOP	1-1/4" - 11-1/2 NPTF	A.I. 316	5.38	136.7	2.63	66.8	-
1-1/2"	WS12F12-BOP	1-1/2" - 11-1/2 NPTF	acero	5.98	151.9	3.25	82.6	-
	WS12F12-SS-BOP	1-1/2" - 11-1/2 NPTF	A.I. 316	5.98	151.9	3.25	82.6	-
2"	WS16F16-BOP	2" - 11-1/2 NPTF	acero	7.05	179.1	4.00	101.6	-
	WS16F16-SS-BOP	2" - 11-1/2 NPTF	A.I. 316	7.05	179.1	4.00	101.6	-

Información de Intercambio

- Intercambio screw-together para alta presión
- Parker/Pioneer Serie 3000, Enerpac C604, Stucchi IVHP
- Hansen WS56000, Snap-Tite 76-Series, DNP PVM
- Intercambiable a ISO 14540

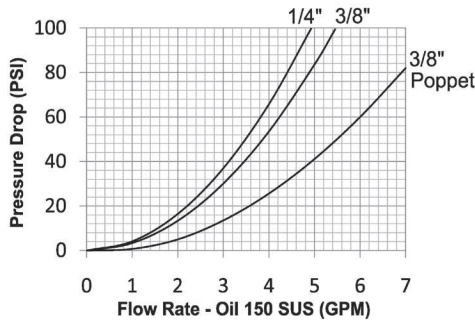

Componentes del Sello

- O-ring de nitrilo con refuerzo de TPC-ET es estándar con un rango de temperatura de -40°F a 250°F (-40°C a 121°C)

Materiales

- Los componentes son maquinados con barras sólidas de acero o acero inoxidable 316.
- Válvula de bola de cromo mecánicamente sentada para mejorar el sellado a presión
- Los nipples de acero son maquinados de una barra de acero sólido endurecido
- Los componentes de acero son platinados con cromo trivalente y cumplen con la norma ROHS

Tabla de Valores de Presión

Medida	Serie-T 10K Roscado (Conectado)															
	Cople/Niple Bola Acero				Cople/Niple Bola Al 316				Copler/Niple Poppet Acero				Copler/Niple Poppet Al 316			
	Trabajo Max.		Reventón		Trabajo Max.		Reventón		Trabajo Max.		Reventón		Trabajo Max.		Reventón	
	PSI	Bar	PSI	Bar	PSI	Bar	PSI	Bar	PSI	Bar	PSI	Bar	PSI	Bar	PSI	Bar
1/4"	10,000	700	34,300	2,350	-	-	-	-	-	-	-	-	-	-	-	-
3/8"	10,000	700	30,000	2,050	10,000	700	30,900	2,100	10,000	700	36,800	2,500	10,000	700	36,500	2,500

Especificaciones Técnicas

Medida	Estándar Intercambio				Parámetros Funcionales					
	Ejército USA	Gobierno USA	Estántar Int	Estándar ANSI/NFPA	Tipo Válvula	Inclusión Aire	Pérdida Fluido	Vacío pulg HG	Flujo ΔP = 60 PSI	
1/4"	-	-	ISO14540	-	ball	0.97	0.56	N/R	3.8 GPM	
3/8"	-	-	ISO14540	-	ball	2.04	0.98	N/R	4.2 GPM	
	-	-	ISO14540	-	poppet	1.56	0.77	N/R	6.0 GPM	

Opciones Disponibles

Medida	Opción de Sello		Opcion*s de Sello Kalrez®			Opciones de Válvula		Tratamiento
	FKM	Mil-Nitrilo	4079	6375	7075	Sin válvula	Al 316	Oxy-Clean
1/4"	F-	M-	K4-	K6-	K7-	-E	N/A	-C1
3/8"	F-	M-	K4-	K6-	K7-	-E	N/A	-C1

Perfil Serie-T

Tamaño	A	B
1/4"	0.62	0.44
3/8"	0.37	0.63

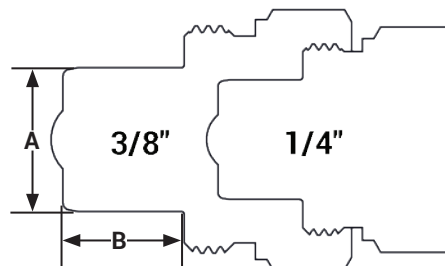

Coples Hidráulicos: Serie-T

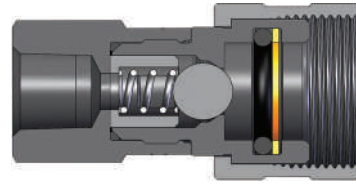

Serie-T Cople Bola 10K Roscado (Roscas Hembra)

Medida	Detalle			Medida		DE Máximo		Hex pulg
	# Parte	Roscas	Material	pulg	mm	pulg	mm	
1/4"	2TF2	1/4" - 18 NPTF	acero	2.09	53.09	1.13	28.70	13/16"
3/8"	3TF3	3/8" - 18 NPTF	acero	2.54	64.60	1.37	34.70	1"

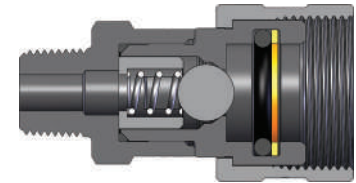

Serie-T Cople Bola 10K Roscado (Roscas Macho)

Medida	Detalle			Medida		DE Máximo		Hex pulg
	# Parte	Roscas	Material	pulg	mm	pulg	mm	
1/4"	2TM2	1/4" - 18 NPTF	acero	2.16	54.9	1.13	28.6	13/16"
3/8"	3TM3	3/8" - 18 NPTF	acero	2.59	65.8	1.37	34.7	1"
	3TM3-SS	3/8" - 18 NPT	A.I. 316	2.59	65.8	1.37	34.7	1"

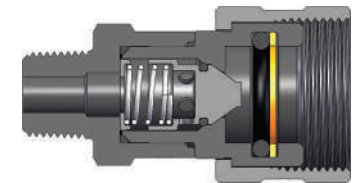

Serie-T Cople Poppet 10K Roscado (Roscas Macho)

Medida	Detalle			Medida		DE Máximo		Hex pulg
	# Parte	Roscas	Material	pulg	mm	pulg	mm	
3/8"	3TM3-PV	3/8" - 18 NPT	acero	2.78	70.7	1.36	34.5	1"
	3TM3-SS-PV	3/8" - 18 NPT	A.I. 316	2.78	70.7	1.36	34.5	1"

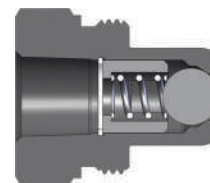

Serie-T Niple Bola 10K Roscado (Roscas Hembra)

Medida	Detalle			Medida		DE Máximo		Hex pulg
	# Parte	Roscas	Material	pulg	mm	pulg	mm	
1/4"	T2F2	1/4" - 18 NPTF	acero	1.29	32.9	1.07	27.2	1-1/16"
3/8"	T3F3	3/8" - 18 NPTF	acero	1.56	39.7	1.35	34.3	1-1/4"
	T3F3-SS	3/8" - 18 NPT	A.I. 316	1.56	39.7	1.35	34.3	1-1/4"

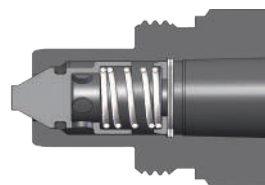
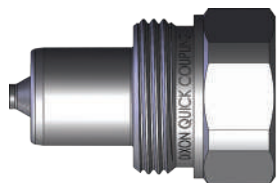

Medida	Serie-T Niple Poppet 10K Roscado (Roscas Hembra)							
	Detalle			Medida		DE Máximo		Hex pulg
	# Parte	Roscas	Material	pulg	mm	pulg	mm	
3/8"	T3F3-PV	3/8" - 18 NPT	acero	1.53	38.9	1.19	30.2	15/16"
	T3F3-SS-PV	3/8" - 18 NPT	A.I. 316	1.53	38.9	1.19	30.2	15/16"



Medida	Serie-T Tapón Rígido para Cople		
	Detalle		
	# Parte	Cuerda	Cuerpo
1/4"	2TDP	Hule	acero
3/8"	3TDP	Hule	acero



Medida	Serie-T Tapa Rígida para Cople		
	Detalle		
	# Parte	Cuerda	Cuerpo
1/4"	T2DC	cable de acero	acero
3/8"	T3DC	cable de acero	acero

Medida	Serie-T Kit de Sellos para Cople Roscado 10K			
	Detalle			Contenido de Kit de Sellos
	# Parte	Estilo de Cople	Material de Sello	
1/4"	2T-SKIT	Válvula Bola	nitrilo	O-ring nitrilo con anillo Hytrel de repuesto
3/8"	3T-SKIT	Válvula Bola	nitrilo	O-ring nitrilo con anillo Hytrel de repuesto

Información de Intercambio

- Intercambiable con ISO14541 1/4" - 3/4"
- Intercambio Europeo screw-together
- Inteva STG-Series, Faster Serie-CVV, DNP PVV3, Voswinkel Type-HS

Materiales

- Los componentes son maquinados con barras sólidas de acero
- Anillos de retención y resortes de acero maximizan la resistencia a la corrosión y extienden la vida del servicio
- Los componentes de acero son platinados con cromo trivalente y cumplen con la norma ROHS

Componentes del Sello

- Sellos de nitrilo (Buna-N) energizados neumáticamente son estándar, brinda un rango de temperatura de -13°F a 257°F (-25°C a 125°C)
- Los nipples tienen un anillo PTFE anti-extrusión para prevenir daños por presión de impulso dinámico.



Tabla de Valores de Presión

Medida	Serie-CVV Intercambio Europeo Screw-Together			
	Cople/Niple Conectado			
	Trabajo Máximo		Reventón	
	PSI	Bar	PSI	Bar
1/4"	6,500	450	26,000	1,800
3/8"	6,500	450	26,000	1,800
1/2"	5,800	400	23,200	1,600
3/4"	5,800	400	23,200	1,600
1"	4,400	300	17,600	1,200
1-1/4"	4,400	300	17,600	1,200

Especificaciones Técnicas

Medida	Estándar Intercambio				Parámetros Funcionales				
	Ejército USA	Gobierno USA	Estándar Int	Estándar ANSI/NFPA	Mecanismo Seguridad	Inclusión Aire	Pérdida Fluido	Vacío Pulg HG	Flujo ΔP = 22 PSI
1/4"	-	-	ISO14541	-	Roscado	N/A	N/A	27.4	7 GPM
3/8"	-	-	ISO14541	-	Roscado	N/A	N/A	27.4	10 GPM
1/2"	-	-	ISO14541	-	Roscado	N/A	N/A	27.4	15 GPM
3/4"	-	-	ISO14541	-	Roscado	N/A	N/A	27.4	26 GPM
1"	-	-	-	-	Roscado	N/A	N/A	27.4	45 GPM
1-1/4"	-	-	-	-	Roscado	N/A	N/A	27.4	70 GPM

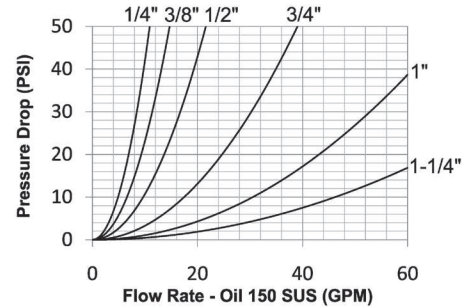
NOTA: Las mangas roscadas permiten una fácil conexión mientras el sistema está bajo presión residual.

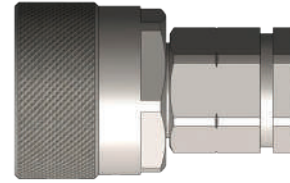
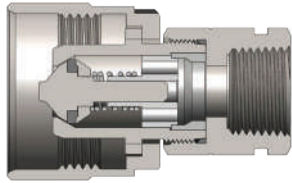

Medida	Serie-CVV Cople Intercambio Europeo (Roscas Hembra)							
	Detalle			Medida		DE Máximo		Hex mm
	# Parte	Roscas	Material	pulg	mm	pulg	mm	
1/4"	2CVVF2	1/4" - 18 NPTF	acero	2.33	59.3	1.34	34.0	19
	2CVVBF2	1/4" - 19 BSPP	acero	2.33	59.3	1.34	34.0	19
	2CVVFM1415	M14X1.5	acero	2.33	59.3	1.34	34.0	19
3/8"	3CVVF3	3/8" - 18 NPTF	acero	2.41	61.2	1.34	34.0	22
	3CVVBF3	3/8" - 19 BSPP	acero	2.41	61.2	1.34	34.0	22
	3CVVFM1615	M16X1.5	acero	2.41	61.2	1.34	34.0	22
1/2"	4CVVF4	1/2" - 14 NPTF	acero	2.66	67.5	1.65	41.8	27
	4CVVOF4	3/4" - 16 ORB	acero	2.66	67.5	1.65	41.8	27
	4CVVBF4	1/2" - 14 BSPP	acero	2.66	67.5	1.65	41.8	27
	4CVVFM1815	M18X1.5	acero	2.66	67.5	1.65	41.8	27
	4CVVOF5	7/8" - 14ORB	acero	2.66	67.5	1.65	41.8	27
	4CVVFM2215	M22X1.5	acero	2.66	67.5	1.65	41.8	27
3/4"	6CVVF6	3/4" - 14 NPTF	acero	3.15	80.0	1.89	48.0	36
	6CVVBF6	3/4" - 14 BSPP	acero	3.15	80.0	1.89	48.0	36
	6CVVFM2215	M22X1.5	acero	3.15	80.0	1.89	48.0	36
1"	8CVVF8	1" - 11-1/2 NPTF	acero	3.30	83.9	2.35	59.8	41
	8CVVBF8	1" - 11 BSPP	acero	3.30	83.9	2.35	59.8	41
1-1/4"	10CVVF10	1-1/4" - 11-1/2 NPTF	acero	5.59	142.0	3.14	79.8	50
	10CVVBF10	1-1/4" - 11 BSPP	acero	5.59	142.0	3.14	79.8	50

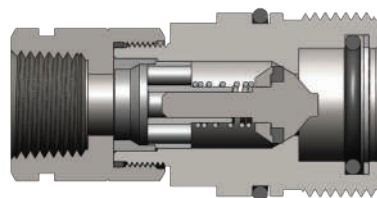
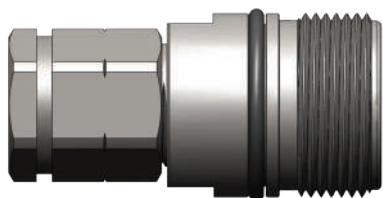

Medida	Serie-CVV Niple Intercambio Europeo (Roscas Hembra)							
	Detalle			Medida		DE Máximo		Hex mm
	# Parte	Roscas	Material	pulg	mm	pulg	mm	
1/4"	CVV2F2	1/4" - 18 NPTF	acero	2.36	60.0	0.94	24.0	19
	CVV2BF2	1/4" - 19 BSPP	acero	2.36	60.0	0.94	24.0	19
	CVV2FM1415	M14X1.5	acero	2.36	60.0	0.94	24.0	19
3/8"	CVV3F3	3/8" - 18 NPTF	acero	2.52	64.0	1.10	28.0	22
	CVV3BF3	3/8" - 19 BSPP	acero	2.52	64.0	1.10	28.0	22
	CVV3FM1615	M16X1.5	acero	2.52	64.0	1.10	28.0	22
1/2"	CVV4F4	1/2" - 14 NPTF	acero	2.76	70.0	1.42	36.0	27
	CVV4OF4	3/4" - 16 ORB	acero	2.76	70.0	1.42	36.0	27
	CVV4BF4	1/2" - 14 BSPP	acero	2.76	70.0	1.42	36.0	27
	CVV4FM1815	M18X1.5	acero	2.76	70.0	1.42	36.0	27
	CVV4OF5	7/8" - 14ORB	acero	2.76	70.0	1.42	36.0	27
	CVV4FM2215	M22X1.5	acero	2.76	70.0	1.42	36.0	27
3/4"	CVV6F6	3/4" - 14 NPTF	acero	3.39	86.0	1.65	42.0	36
	CVV6BF6	3/4" - 14 BSPP	acero	3.39	86.0	1.65	42.0	36
	CVV6FM2215	M22X1.5	acero	3.39	86.0	1.65	42.0	36
1"	CVV8F8	1" - 11-1/2 NPTF	acero	3.94	100.0	1.89	48.0	41
	CVV8BF8	1" - 11 BSPP	acero	3.94	100.0	1.89	48.0	41
1-1/4"	CVV10F10	1-1/4" - 11-1/2 NPTF	acero	5.91	150.0	2.76	70.0	50
	CVV10BF10	1-1/4" - 11 BSPP	acero	5.91	150.0	2.76	70.0	50



Medida	Serie-CVV Tapón Intercambio Europeo		
	Detalle		
	# Parte	Cuerda	Cuerpo
1/4"	2CVVDP	plástico	plástico
3/8"	3CVVDP	plástico	plástico
1/2"	4CVVDP	plástico	plástico
3/4"	6CVVDP	plástico	plástico
1"	8CVVDP	plástico	plástico
1-1/4"	10CVVDP	plástico	plástico



Medida	Serie-CVV Tapa Intercambio Europeo		
	Detalle		
	# Parte	Cuerda	Cuerpo
1/4"	CVV2DC	plástico	plástico
3/8"	CVV3DC	plástico	plástico
1/2"	CVV4DC	plástico	plástico
3/4"	CVV6DC	plástico	plástico
1"	CVV8DC	plástico	plástico
1-1/4"	CVV10DC	plástico	plástico

Perfil Serie-CVV

Tamaño	A	B
1/4"	0.94	0.50
3/8"	1.10	0.57
1/2"	1.41	0.66
3/4"	1.64	0.77
1"	1.88	0.77
1-1/4"	2.75	1.28

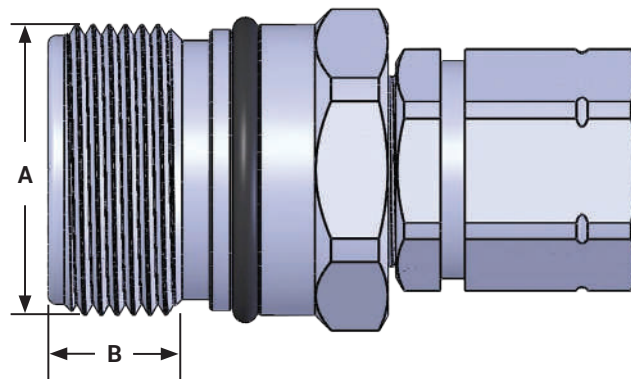

Coples Hidráulicos: Serie-TD

Información de Intercambio

- Spir Star CQD Series, DNP CRS Series, Jetstream Tipo tornillo

Materiales

- Los componentes son maquinados con barras sólidas de acero o acero inoxidable 316.
- Anillos de retención y resortes de acero inoxidable maximizan la resistencia a la corrosión y extienden la vida del servicio.

Componentes del Sello

- Sellos de Nitrilo (Buna-N) estándar brindan un rango de temperatura de **-40°F a 250°F (-40°C a 121°C)**
- Los coples tiene anillo anti-extrusión, brindando resistencia al O-ring de daños por impulso dinámico.



Tabla de Valores de Presión

Medida	Serie-TD Acoples Roscados 15K y 20K	
	Trabajo Máximo	
	PSI	Bar
1/2" x 1/2" NPTF	15,000	1,034
1/2" x 9/16" MP	20,000	1,379

Especificaciones Técnicas

Medida	Estándar Intercambio				Parámetros Funcionales				
	Ejército USA	Gobierno USA	Estántar Int	Estándar ANSI/NFPA	Roscado	Inclusión Aire	Pérdida Fluido	Vacío pulg HG	Flujo ΔP = 40 PSI
1/2"	-	-	-	-	Maxi-Latch	N/A	N/A	N/R	40 GPM

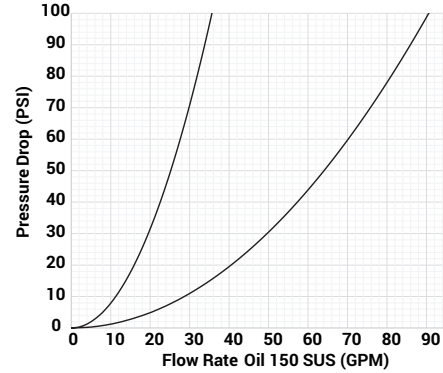
Tamaño	A	B
1/2"	.75	.63

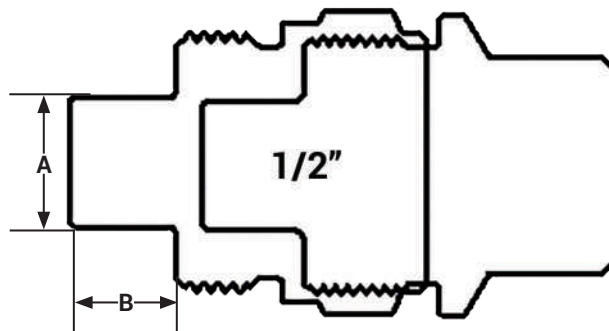

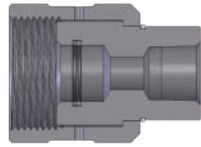

Medida	T-Series 15K Roscado Coupler (Roscas Hembra)							
	Detalle			Medida		DE Máximo		Hex mm
	# Parte	Roscas	Material	pulg	mm	pulg	mm	
1/2"	4TDF4-SS	1/2" - 14 NPTF	A.I. 316 acero	2.57	65.28	1.85	46.99	1.13

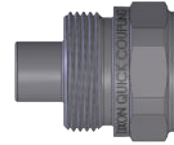
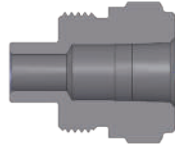

Medida	Serie-T Niple Roscado 15K (Roscas Hembra)							
	Detalle			Medida		DE Máximo		Hex mm
	# Parte	Roscas	Material	pulg	mm	pulg	mm	
1/2"	TD4F4-SS	1/2" - 14 NPTF	A.I. 316 acero	2.06	52.32	1.75	44.45	1.63



Medida	Serie-T Cople Roscado 20K (Roscas Hembra MP)							
	Detalle			Medida		DE Máximo		Hex mm
	# Parte	Roscas	Material	pulg	mm	pulg	mm	
1/2"	4TDPF4.5-SS	9/16" MP	A.I. 316 acero	2.85	72.39	1.88	47.75	1.13

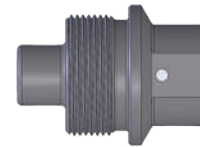
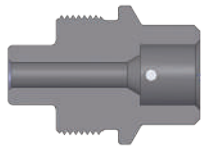

Medida	Serie-T Niple Roscado 20K (Roscas Hembra MP)							
	Detalle			Medida		DE Máximo		Hex mm
	# Parte	Roscas	Material	pulg	mm	pulg	mm	
1/2"	TD4PF4.5-SS	9/16" MP	A.I. 316 acero	2.40	60.96	1.74	44.20	1.13

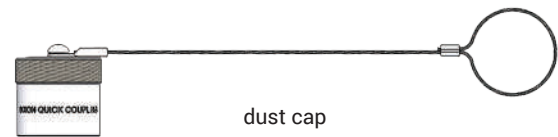
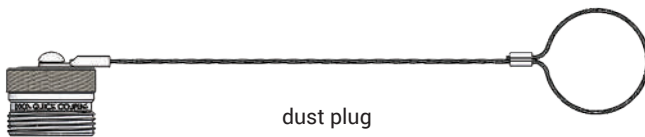

Medida	Serie-T Tapa y Tapón Guardapolvo							
	Detalle				Medida		DE Máximo	
	# Parte	Description	Roscas	Material	pulg	mm	pulg	mm
1/2"	TD4DC-A	tapa	1/2" - 14 NPTF	aluminio	10	254	1.73	43.94
	TD4.5DC-A	tapa	9/16" MP	aluminio	10	254	1.69	42.93
	4TDDP-A	tapón	1/2" - 14 NPTF	aluminio	10	254	1.50	38.10
	4.5TDDP-A	tapón	9/16" MP	aluminio	10	254	1.50	38.10

Coples Hidráulicos: Serie-E

Información de Intercambio

- Intercambio Straight-through pressure-wash
- Parker Serie-ST, Foster Serie-FST, Hansen Serie-ST

Componentes del Sello

- Sellos de Nitrilo (Buna-N) estándar brindan un rango de temperatura de -40°F a 250°F (-40°C a 121°C)

Materiales

- Los componentes son maquinados con barras sólidas de acero o acero inoxidable 303.
- Balines, anillos de retención, y resortes de acero inoxidable que extienden la vida del servicio
- Los componentes de acero son platinados con cromo trivalente y cumplen con la norma ROHS
- Los coples de 1-1/4" a 2" de latón tienen mangas de acero para maximizar la vida del servicio y están endurecidos para resistir la deformación.
- Los nipples de acero están endurecidos para brindar un desempeño de trabajo pesado.



Tabla de Valores de Presión

Medida	Serie-E Intercambio Straight-Through (Conectado)											
	Cople Latón/Niple Acero				Cople/Niple Latón				Cople/Niple A.I. 303			
	Trabajo Max.		Reventón		Trabajo Max.		Reventón		Trabajo Max.		Reventón	
	PSI	Bar	PSI	Bar	PSI	Bar	PSI	Bar	PSI	Bar	PSI	Bar
1/8"	2,600	179	10,400	717	2,500	172	10,000	689	4,200	290	16,800	1,158
1/4"	5,500	379	22,000	1,517	5,200	359	20,800	1,434	6,700	462	26,800	1,848
3/8"	3,500	241	14,000	966	2,700	186	10,800	745	5,500	379	22,000	1,517
1/2"	2,700	186	10,800	745	2,200	152	8,800	607	3,000	207	12,000	827
3/4"	2,700	186	10,800	745	1,700	117	6,800	469	3,000	207	12,000	827
1"	2,000	138	8,000	552	1,200	83	4,800	331	1,700	117	6,800	469
1-1/4"	2,000	138	8,000	552	1,700	117	6,800	469	2,000	138	8,000	552
1-1/2"	2,000	138	8,000	552	1,400	97	5,600	386	2,000	138	8,000	552
2"	2,000	138	8,000	552	1,400	97	5,600	386	2,000	138	8,000	552

Especificaciones Técnicas

Medida	Estándar Intercambio				Parámetros Funcionales				
	Ejército USA	Gobierno USA	Estántar Int	Estándar ANSI/NFPA	Cant Balines	Inclusión Aire	Pérdida Fluido	Vacío pulg HG	Flujo ΔP = 15 PSI
1/8"	-	-	-	-	6	N/A	N/A	N/R	3 GPM
1/4"	-	-	-	-	6	N/A	N/A	N/R	6 GPM
3/8"	-	-	-	-	8	N/A	N/A	N/R	14 GPM
1/2"	-	-	-	-	8	N/A	N/A	N/R	24 GPM
3/4"	-	-	-	-	8	N/A	N/A	N/R	58 GPM
1"	-	-	-	-	8	N/A	N/A	N/R	100 GPM
1-1/4"	-	-	-	-	8	N/A	N/A	N/R	150 GPM
1-1/2"	-	-	-	-	8	N/A	N/A	N/R	250 GPM
2"	-	-	-	-	8	N/A	N/A	N/R	350 GPM

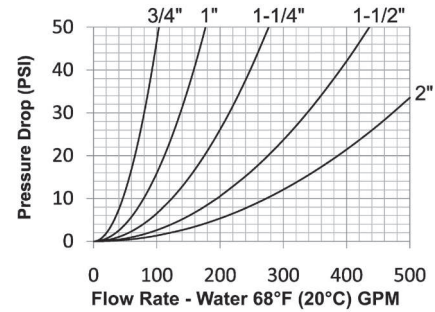
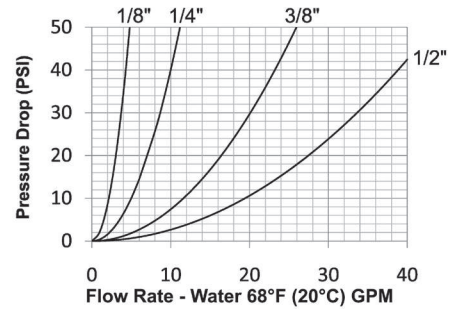
Opciones Disponibles

Medida	Opciones de Sellado Estándar				Opcion*s de Sello Kalrez®			Otras Opciones	
	FKM	EPDM	Mil-Nitrilo	Silicón	4079	6375	7075	Sleeve-Lock	Oxy-Clean
1/8"	F-	P-	M-	S-	N/A	N/A	N/A	-LS	-C1
1/4"	F-	P-	M-	S-	N/A	N/A	N/A	-LS	-C1
3/8"	F-	P-	M-	S-	N/A	N/A	N/A	-LS	-C1
1/2"	F-	P-	M-	S-	N/A	N/A	N/A	-LS	-C1
3/4"	F-	P-	M-	S-	N/A	N/A	N/A	-LS	-C1
1"	F-	P-	M-	S-	N/A	N/A	N/A	-LS	-C1
1-1/4"	F-	P-	M-	S-	N/A	N/A	N/A	-LS	-C1
1-1/2"	F-	P-	M-	S-	N/A	N/A	N/A	-LS	-C1
2"	F-	P-	M-	S-	N/A	N/A	N/A	-LS	-C1

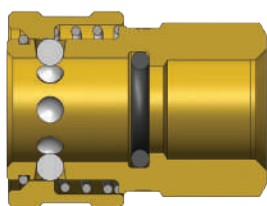

Serie-E Cople Intercambio Straight-Through (Roscas Hembra)

Medida	Detalle							
	# Parte	Roscas	Material	Medida		DE Máximo		Hex pulg
				pulg	mm	pulg	mm	
1/8"	1EF1-B	1/8" - 27 NPTF	latón	1.01	25.7	0.65	16.5	9-16"
	1EF1-S	1/8" - 27 NPTF	Al 303	1.01	25.7	0.65	16.5	9/16"
1/4"	2EF2-B	1/4" - 18 NPTF	latón	1.40	35.6	0.96	24.4	13/16"
	2EF2-S	1/4" - 18 NPTF	Al 303	1.40	35.6	0.96	24.4	13/16"
	2EBF2-B	1/4" - 19 BSPP	latón	1.40	35.6	0.96	24.4	13/16"
3/8"	3EF3-B	3/8" - 18 NPTF	latón	1.60	40.6	1.13	28.7	1"
	3EF3-S	3/8" - 18 NPTF	Al 303	1.60	40.6	1.13	28.7	1"
	3EBF3-B	3/8" - 19 BSPP	latón	1.60	40.6	1.13	28.7	1"
1/2"	4EF4-B	1/2" - 14 NPTF	latón	1.96	49.8	1.27	32.3	1-1/8"
	4EF4-S	1/2" - 14 NPTF	Al 303	1.96	49.8	1.27	32.3	1-1/8"
	4EBF4-B	1/2" - 14 BSPP	latón	1.96	49.8	1.27	32.3	1-1/8"
3/4"	6EF6-B	3/4" - 14 NPTF	latón	2.10	53.3	1.65	41.9	1-1/2"
	6EF6-S	3/4" - 14 NPTF	Al 303	2.10	53.3	1.65	41.9	1-1/2"
	6EBF6-B	3/4" - 14 BSPP	latón	2.10	53.3	1.65	41.9	1-1/2"
1"	8EF8-B	1" - 11-1/2 NPTF	latón	2.36	59.9	2.02	51.3	1-3/4"
	8EF8-S	1" - 11-1/2 NPTF	Al 303	2.36	59.9	2.02	51.3	1-3/4"
	8EBF8-B	1" - 11 BSPP	latón	2.36	59.9	2.02	51.3	1-3/4"
1-1/4"	10EF10-B	1-1/4" - 11-1/2 NPTF	latón	2.36	59.9	2.59	65.8	2-1/4"
	10EF10-S	1-1/4" - 11-1/2 NPTF	Al 303	2.36	59.9	2.59	65.8	2-1/4"
1-1/2"	12EF12-B	1-1/2" - 11-1/2 NPTF	latón	2.89	73.4	3.18	80.8	2-3/4"
	12EF12-S	1-1/2" - 11-1/2 NPTF	Al 303	2.89	73.4	3.18	80.8	2-3/4"
2"	16EF16-B	2" - 11-1/2 NPTF	latón	3.00	76.2	4.04	102.6	3-1/2"
	16EF16-S	2" - 11-1/2 NPTF	Al 303	3.00	76.2	4.04	102.6	3-1/2"

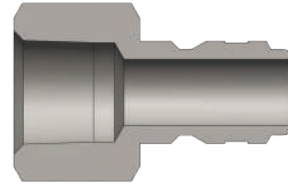

Medida	Serie-E Niple Intercambio Straight-Through (Roscas Hembra)							
	Detalle			Medida		DE Máximo		Hex pulg
	# Parte	Roscas	Material	pulg	mm	pulg	mm	
1/8"	E1F1	1/8" - 27 NPTF	acero	0.98	24.9	0.65	16.5	9/16"
	E1F1-B	1/8" - 27 NPTF	latón	0.98	24.9	0.65	16.5	9/16"
	E1F1-S	1/8" - 27 NPTF	Al 303	0.98	24.9	0.65	16.5	9/16"
1/4"	E2F2	1/4" - 18 NPTF	acero	1.47	37.3	0.79	20.1	11/16"
	E2F2-B	1/4" - 18 NPTF	latón	1.47	37.3	0.79	20.1	11/16"
	E2F2-S	1/4" - 18 NPTF	Al 303	1.47	37.3	0.79	20.1	11/16"
	E2BF2-B	1/4" - 19 BSPP	latón	1.47	37.3	0.79	20.1	11/16"
3/8"	E3F3	3/8" - 18 NPTF	acero	1.60	40.6	1.01	25.7	7/8"
	E3F3-B	3/8" - 18 NPTF	latón	1.60	40.6	1.01	25.7	7/8"
	E3F3-S	3/8" - 18 NPTF	Al 303	1.60	40.6	1.01	25.7	7/8"
	E3BF3-B	3/8" - 19 BSPP	latón	1.60	40.6	1.01	25.7	7/8"
1/2"	E4F4	1/2" - 14 NPTF	acero	1.82	46.2	1.16	29.5	1"
	E4F4-B	1/2" - 14 NPTF	latón	1.82	46.2	1.16	29.5	1"
	E4F4-S	1/2" - 14 NPTF	Al 303	1.82	46.2	1.16	29.5	1"
	E4BF4-B	1/2" - 14 BSPP	latón	1.82	46.2	1.16	29.5	1"
3/4"	E6F6	3/4" - 14 NPTF	acero	2.05	52.1	1.37	34.8	1-3/16"
	E6F6-B	3/4" - 14 NPTF	latón	2.05	52.1	1.37	34.8	1-3/16"
	E6F6-S	3/4" - 14 NPTF	Al 303	2.05	52.1	1.37	34.8	1-3/16"
	E6BF6-B	3/4" - 14 BSPP	latón	2.05	52.1	1.37	34.8	1-3/16"
1"	E8F8	1" - 11-1/2 NPTF	acero	2.36	59.9	1.73	43.9	1-1/2"
	E8F8-B	1" - 11-1/2 NPTF	latón	2.36	59.9	1.73	43.9	1-1/2"
	E8F8-S	1" - 11-1/2 NPTF	Al 303	2.36	59.9	1.73	43.9	1-1/2"
	E8BF8-B	1" - 11 BSPP	latón	2.36	59.9	1.73	43.9	1-1/2"
1-1/4"	E10F10	1-1/4" - 11-1/2 NPTF	acero	2.47	62.7	2.31	58.7	2"
	E10F10-B	1-1/4" - 11-1/2 NPTF	latón	2.47	62.7	2.31	58.7	2"
	E10F10-S	1-1/4" - 11-1/2 NPTF	Al 303	2.47	62.7	2.31	58.7	2"
1-1/2"	E12F12	1-1/2" - 11-1/2 NPTF	acero	2.74	69.6	2.60	66.0	2-1/4"
	E12F12-B	1-1/2" - 11-1/2 NPTF	latón	2.74	69.6	2.60	66.0	2-1/4"
	E12F12-S	1-1/2" - 11-1/2 NPTF	Al 303	2.74	69.6	2.60	66.0	2-1/4"
2"	E16F16	2" - 11-1/2 NPTF	acero	3.00	76.2	3.03	77.0	2-5/8"
	E16F16-B	2" - 11-1/2 NPTF	latón	3.00	76.2	3.03	77.0	2-5/8"
	E16F16-S	2" - 11-1/2 NPTF	Al 303	3.00	76.2	3.03	77.0	2-5/8"

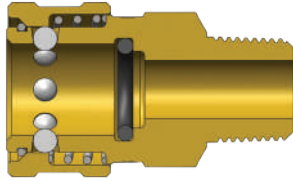

Medida	Serie-E Cople Intercambio Straight-Through (Roscas Macho)							
	Detalle			Medida		DE Máximo		Hex pulg
	# Parte	Roscas	Material	pulg	mm	pulg	mm	
1/8"	1EM1-B	1/8" - 27 NPTF	latón	1.01	25.7	0.65	16.5	9/16"
	1EM1-S	1/8" - 27 NPTF	Al 303	1.01	25.7	0.65	16.5	9/16"
1/4"	2EM2-B	1/4" - 18 NPTF	latón	1.66	42.2	0.96	24.4	13/16"
	2EM2-S	1/4" - 18 NPTF	Al 303	1.66	42.2	0.96	24.4	13/16"
3/8"	3EM3-B	3/8" - 18 NPTF	latón	1.70	43.2	1.13	28.7	1"
	3EM3-S	3/8" - 18 NPTF	Al 303	1.70	43.2	1.13	28.7	1"
1/2"	4EM4-B	1/2" - 14 NPTF	latón	2.00	50.8	1.27	32.3	1-1/8"
	4EM4-S	1/2" - 14 NPTF	Al 303	2.00	50.8	1.27	32.3	1-1/8"
3/4"	6EM6-B	3/4" - 14 NPTF	latón	2.24	56.9	1.65	41.9	1-1/2"
	6EM6-S	3/4" - 14 NPTF	Al 303	2.24	56.9	1.65	41.9	1-1/2"
1"	8EM8-B	1" - 11-1/2 NPTF	latón	2.61	66.3	2.02	51.3	1-3/4"
	8EM8-S	1" - 11-1/2 NPTF	Al 303	2.61	66.3	2.02	51.3	1-3/4"
1-1/4"	10EM10-B	1-1/4" - 11-1/2 NPTF	latón	2.91	73.9	2.59	65.8	2-1/4"
1-1/2"	12EM12-B	1-1/2" - 11-1/2 NPTF	latón	3.44	87.4	3.18	80.8	2-3/4"
2"	16EM16-B	2" - 11-1/2 NPTF	latón	3.70	94.0	4.04	102.6	3-1/2"

Perfil Serie-E

Tamaño	A	B
1/8"	0.26	0.08
1/4"	0.40	0.11
3/8"	0.49	0.13
1/2"	0.64	0.13
3/4"	0.89	0.17
1"	1.20	0.17
1-1/4"	1.45	0.12
1-1/2"	1.79	0.17
2"	2.27	0.17

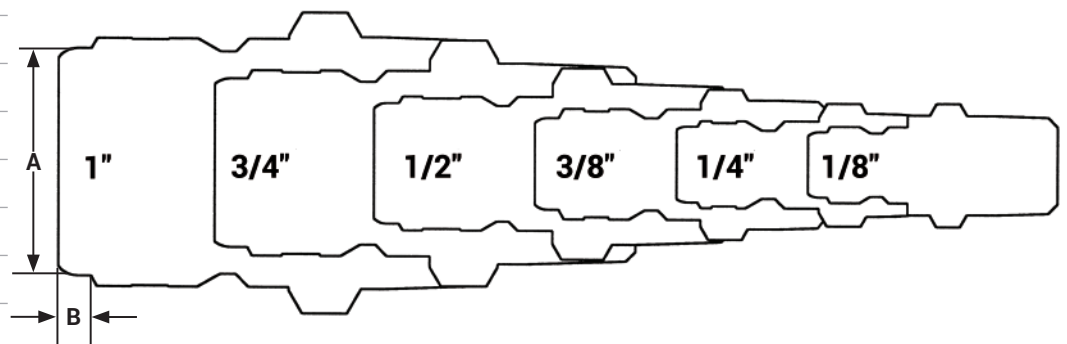

Coples Hidráulicos: Serie-E

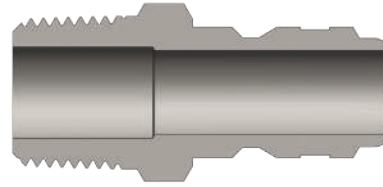
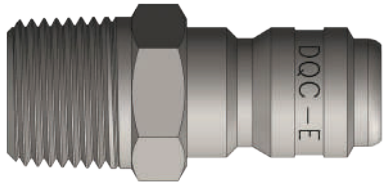

Medida	Serie-E Niple Intercambio Straight-Through (Roscas Macho)							
	Detalle			Medida		DE Máximo		Hex pulg
	# Parte	Roscas	Material	pulg	mm	pulg	mm	
1/8"	E1M1	1/8" - 27 NPTF	acero	1.15	29.2	0.58	14.7	1/2"
	E1M1-B	1/8" - 27 NPTF	latón	1.15	29.2	0.58	14.7	1/2"
	E1M1-S	1/8" - 27 NPTF	Al 303	1.15	29.2	0.58	14.7	1/2"
1/4"	E2M2	1/4" - 18 NPTF	acero	1.50	38.1	0.65	16.5	9/16"
	E2M2-B	1/4" - 18 NPTF	latón	1.50	38.1	0.65	16.5	9/16"
	E2M2-S	1/4" - 18 NPTF	Al 303	1.50	38.1	0.65	16.5	9/16"
3/8"	E3M3	3/8" - 18 NPTF	acero	1.69	42.9	0.79	20.1	11/16"
	E3M3-B	3/8" - 18 NPTF	latón	1.69	42.9	0.79	20.1	11/16"
	E3M3-S	3/8" - 18 NPTF	Al 303	1.69	42.9	0.79	20.1	11/16"
1/2"	E4M4	1/2" - 14 NPTF	acero	1.91	48.5	1.01	25.7	7/8"
	E4M4-B	1/2" - 14 NPTF	latón	1.91	48.5	1.01	25.7	7/8"
	E4M4-S	1/2" - 14 NPTF	Al 303	1.91	48.5	1.01	25.7	7/8"
3/4"	E6M6	3/4" - 14 NPTF	acero	2.25	57.2	1.23	31.2	1-1/16"
	E6M6-B	3/4" - 14 NPTF	latón	2.25	57.2	1.23	31.2	1-1/16"
	E6M6-S	3/4" - 14 NPTF	Al 303	2.25	57.2	1.23	31.2	1-1/16"
1"	E8M8	1" - 11-1/2 NPTF	acero	2.45	62.2	1.59	40.4	1-3/8"
	E8M8-B	1" - 11-1/2 NPTF	latón	2.45	62.2	1.59	40.4	1-3/8"
	E8M8-S	1" - 11-1/2 NPTF	Al 303	2.45	62.2	1.59	40.4	1-3/8"
1-1/4"	E10M10	1-1/4" - 11-1/2 NPTF	acero	2.80	71.1	2.02	51.3	1-3/4"
	E10M10-B	1-1/4" - 11-1/2 NPTF	latón	2.80	71.1	2.02	51.3	1-3/4"
1-1/2"	E12M12	1-1/2" - 11-1/2 NPTF	acero	3.38	85.9	2.60	66.0	2-1/4"
	E12M12-B	1-1/2" - 11-1/2 NPTF	latón	3.38	85.9	2.60	66.0	2-1/4"
2"	E16M16	2" - 11-1/2 NPTF	acero	3.58	90.9	3.03	77.0	2-5/8"
	E16M16-B	2" - 11-1/2 NPTF	latón	3.58	90.9	3.03	77.0	2-5/8"

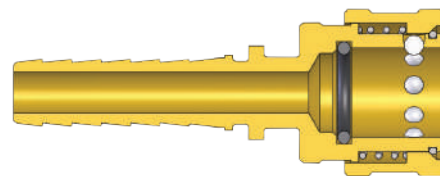
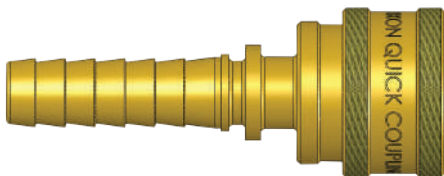

Medida	Serie-E Cople Intercambio Straight-Through (Barba para Manguera)							
	Detalle			Medida		DE Máximo		Hex pulg
	# Parte	DI Manguera	Material	pulg	mm	pulg	mm	
1/4"	2ES2-B	1/4"	latón	2.06	52.2	1.00	25.4	-
3/8"	3ES3-B	3/8"	latón	2.03	51.6	1.13	28.6	-
1/2"	4ES4-B	1/2"	latón	3.45	87.6	1.34	34.0	-
3/4"	6ES6-B	3/4"	latón	3.64	92.3	1.64	41.7	-
1"	8ES8-B	1"	latón	4.58	116.2	1.99	50.5	-

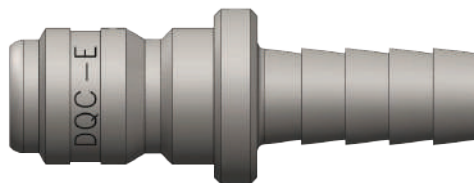
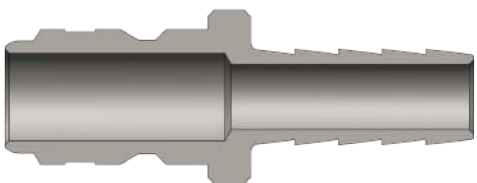

Medida	Serie-E Niple Intercambio Straight-Through (Barba para Manguera)							
	Detalle			Medida		DE Máximo		Hex pulg
	# Parte	DI Manguera	Material	pulg	mm	pulg	mm	
1/4"	E2S2	1/4"	acero	1.90	48.3	0.56	14.2	-
	E2S2-B	1/4"	latón	1.90	48.3	0.56	14.2	-
3/8"	E3S3	3/8"	acero	2.03	51.6	0.63	16.0	-
	E3S3-B	3/8"	latón	2.03	51.6	0.63	16.0	-
1/2"	E4S4	1/2"	acero	2.09	53.1	0.75	19.1	-
	E4S4-B	1/2"	latón	2.09	53.1	0.75	19.1	-
3/4"	E6S6	3/4"	acero	2.28	57.9	1.13	28.7	-
	E6S6-B	3/4"	latón	2.28	57.9	1.13	28.7	-
1"	E8S8	1"	acero	3.28	83.3	1.38	35.1	-
	E8S8-B	1"	latón	3.28	83.3	1.38	35.1	-

Medida	Serie-E Kit de Sellos para Cople Intercambio Straight-Through				
	Detalle			Contenido de Kit de Sellos	
	# Parte	Estilo de Cople	Material		
1/4"	2E-SKIT	Todos	Nitrilo	O-ring de Cuerpo	
	F-2E-SKIT	Todos	FKM	O-ring de Cuerpo	
	P-2E-SKIT	Todos	EPDM	O-ring de Cuerpo	
3/8"	3E-SKIT	Todos	Nitrilo	O-ring de Cuerpo	
	F-3E-SKIT	Todos	FKM	O-ring de Cuerpo	
	P-3E-SKIT	Todos	EPDM	O-ring de Cuerpo	
1/2"	4E-SKIT	Todos	Nitrilo	O-ring de Cuerpo	
	F-4E-SKIT	Todos	FKM	O-ring de Cuerpo	
	P-4E-SKIT	Todos	EPDM	O-ring de Cuerpo	
3/4"	6E-SKIT	Todos	Nitrilo	O-ring de Cuerpo	
	F-6E-SKIT	Todos	FKM	O-ring de Cuerpo	
	P-6E-SKIT	Todos	EPDM	O-ring de Cuerpo	
1"	8E-SKIT	Todos	Nitrilo	O-ring de Cuerpo	
	F-8E-SKIT	Todos	FKM	O-ring de Cuerpo	
	P-8E-SKIT	Todos	EPDM	O-ring de Cuerpo	
1-1/4"	10E-SKIT	Todos	Nitrilo	O-ring de Cuerpo	
	F-10E-SKIT	Todos	FKM	O-ring de Cuerpo	
	P-10E-SKIT	Todos	EPDM	O-ring de Cuerpo	
1-1/2"	12E-SKIT	Todos	Nitrilo	O-ring de Cuerpo	
	F-12E-SKIT	Todos	FKM	O-ring de Cuerpo	
	P-12E-SKIT	Todos	EPDM	O-ring de Cuerpo	
2"	16E-SKIT	Todos	Nitrilo	O-ring de Cuerpo	
	F-16E-SKIT	Todos	FKM	O-ring de Cuerpo	
	P-16E-SKIT	Todos	EPDM	O-ring de Cuerpo	

Coples Hidráulicos: Serie-EA

Información de Intercambio

- Intercambio Water-blast
- Parker Series-WB, Eaton/Aeroquip FD69, Snap-Tite Serie-56

Componentes del Sello

- Sellos de Nitrilo (Buna-N) estándar brindan un rango de temperatura de **-40°F a 250°F (-40°C a 121°C)**
- Los coples tienen un anillo PTFE anti-extrusión protege el O-ring del cople principal de daños por impulso dinámico de presión

Materiales

- Los componentes son maquinados con barras sólidas de acero de alta dureza.
- Anillos de retención, y resortes de acero inoxidable que extienden la vida del servicio
- Los componentes de acero están endurecidos y platinados con níquel sin tensión eléctrica
- Los nipples de acero son endurecidos para brindar un desempeño de trabajo
- Los componentes de acero son platinados con cromo trivalente y cumplen con la norma ROHS



Tabla de Valores de Presión

Medida	Serie-EA Intercambio Water-Blast 'Chorro de Agua' (Conectado)			
	Cople/Niple			
	Trabajo Máximo		Reventón	
	PSI	Bar	PSI	Bar
1/2"	10,000	700	30,000	2,100

Especificaciones Técnicas

Medida	Estándar Intercambio				Parámetros Funcionales				
	Ejército USA	Gobierno USA	Estántar Int	Estándar ANSI/NFPA	Mecanismo Seguridad	Inclusión Aire	Pérdida Fluido	Vacío pulg HG	Flujo ΔP = 40 PSI
1/2"	-	-	-	-	Maxi-Latch	N/A	N/A	N/R	40 GPM

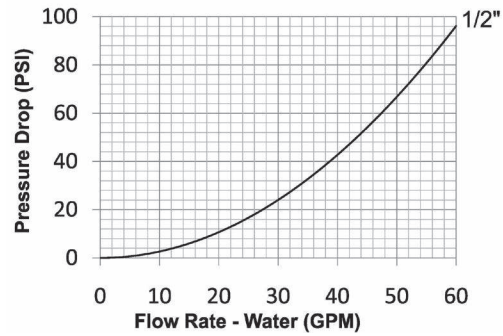
Opciones Disponibles

Medida	Opciones de Sellado Estándar					Opciones de Sello Kalrez®			Otras Opciones	
	FKM	EPDM	FDA FKM	Mil-Nitrilo	Silicón	4079	6375	7075	No Pin-Lock	Oxy-Clean
	Pre	Pre	Pre	Pre	Pre	Pre	Pre	Pre	Suf	Suf
1/2"	F-	P-	D-	M-	S-	K4-	K6-	K7-	-NL	-C1

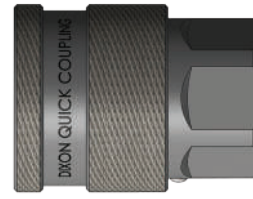
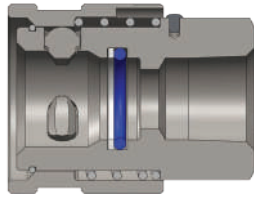

Medida	Serie-EA Cople Intercambio Water-Blast 'Chorro de Agua' (Roscas Hembra)							
	Detalle			Medida		DE Máximo		Hex pulg
	# Parte	Roscas	Material	pulg	mm	pulg	mm	
1/2"	4EAF3	3/8" - 18 NPTF	acero	2.20	55.9	1.62	41.1	1-1/4"
	4EAF4	1/2" - 14 NPTF	acero	2.20	55.9	1.62	41.1	1-1/4"

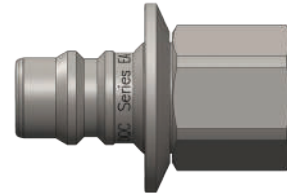
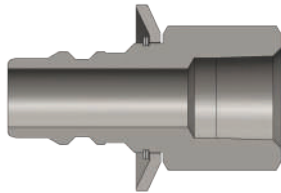

Medida	Serie-EA Niple Intercambio Water-Blast 'Chorro de Agua' (Roscas Hembra)							
	Detalle			Medida		DE Máximo		Hex pulg
	# Parte	Roscas	Material	pulg	mm	pulg	mm	
1/2"	EA4F3	3/8" - 18 NPTF	acero	2.35	59.7	1.62	41.1	1-1/8"
	EA4F4	1/2" - 14 NPTF	acero	2.35	59.7	1.62	41.1	1-1/8"

Medida	Serie-EA Kit de Sellos para Cople Intercambio Water-Blast 'Chorro de Agua'			
	Detalle			Kit de Sellos
	# Parte	Estilo de Cople	Material	Contenido
1/2"	4EA-SKIT	Todos	Nitrilo	O-ring de Cuerpo y Repuesto PTFE
	F-4EA-SKIT	Todos	FKM	O-ring de Cuerpo y Repuesto PTFE
	P-4EA-SKIT	Todos	EPDM	O-ring de Cuerpo y Repuesto PTFE

Serie-EA Profile

Tamaño	A	B
1/2"	0.69	0.35

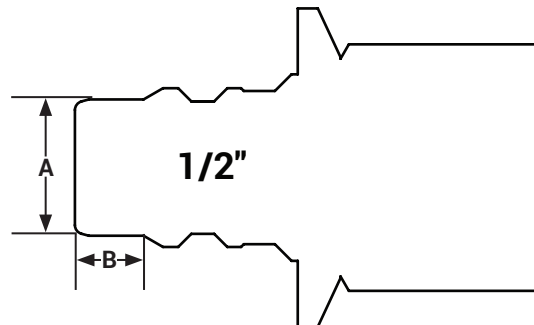

Coples Hidráulicos: Serie-CM

Información de Intercambio

- Intercambio molde enfriador
- Foster Series-FJT, Hansen Flo-Temp, Parker Moldmate, DME Jiffy-Tite

Componentes del Sello

- Empaques y O-rings de silicón estándar con rango de temperatura de -90°F a 400°F (-68°C a 205°C)

Materiales

- Los componentes son maquinados con barras sólidas de acero o latón.
- Balines, anillos de retención y resortes de acero inoxidable maximizan la resistencia a la corrosión y prolongan la vida del servicio
- Los componentes de acero son platinados con cromo trivalente y cumplen con la norma ROHS



Tabla de Valores de Presión

Medida	Serie-CM Intercambio Molde Industrial (Conectado)															
	Cople Sin válvula /Niple Latón				Cople Sin válvula /Niple Acero				Cople con válvula /Niple Latón				Cople con válvula /Niple Acero			
	Trabajo Max.		Reventón		Trabajo Max.		Reventón		Trabajo Max.		Reventón		Trabajo Max.		Reventón	
	PSI	Bar	PSI	Bar	PSI	Bar	PSI	Bar	PSI	Bar	PSI	Bar	PSI	Bar	PSI	Bar
1/4"	300	20	10,000	700	500	35	10,700	750	300	20	6,000	400	300	20	6,100	400
3/8"	300	20	14,500	1,000	500	35	14,200	1,000	300	20	6,700	450	300	20	6,100	400
1/2"	300	20	4,900	340	-	-	-	-	-	-	-	-	-	-	-	-

Especificaciones Técnicas

Medida	Estándar Intercambio				Parámetros Funcionales				
	Ejército USA	Gobierno USA	Estántar Int	Estándar ANSI/NFPA	Cant Balines	Inclusión Aire	Pérdida Fluido	Vacío pulg HG	Flujo ΔP = 7 PSI
1/4"	-	-	-	-	6	N/A	N/A	N/R	3 GPM
3/8"	-	-	-	-	8	N/A	N/A	N/R	9 GPM
1/2"	-	-	-	-	8	N/A	N/A	N/R	15 GPM

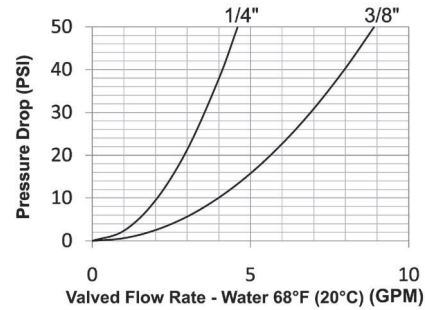
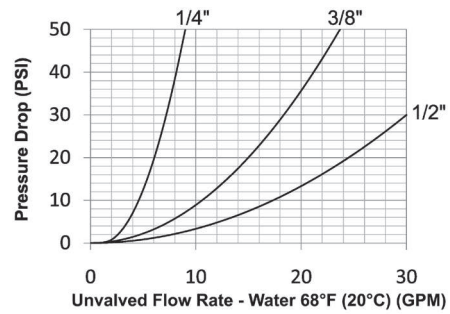
Perfil Serie-CM

Tamaño	A	B
1/4"	0.37	0.32
3/8"	0.53	0.49
1/2"	0.78	0.65

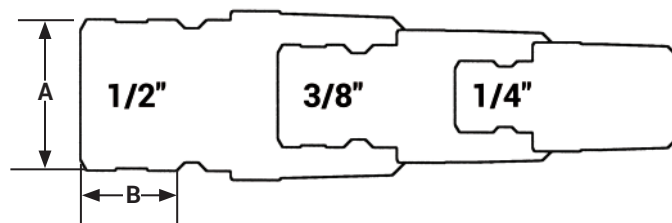

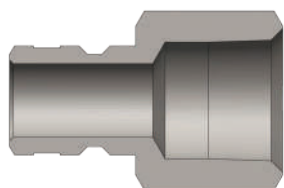

Medida	Serie-CM Niple Intercambio Molde Industrial (Roscas Hembra)							
	Detalle			Medida		DE Máximo		Hex pulg
	# Parte	Roscas	Material	pulg	mm	pulg	mm	
1/4"	CM2F1	1/8" - 27 NPTF	acero	0.90	22.9	0.58	14.7	1/2"
	CM2F1-B	1/8" - 27 NPTF	latón	0.90	22.9	0.58	14.7	1/2"
	CM2F2	1/4" - 18 NPTF	acero	1.12	28.4	0.72	18.3	5/8"
	CM2F2-B	1/4" - 18 NPTF	latón	1.12	28.4	0.72	18.3	5/8"
	CM2F3	3/8" - 18 NPTF	acero	1.12	28.4	0.87	22.1	3/4"
	CM2F3-B	3/8" - 18 NPTF	latón	1.12	28.4	0.87	22.1	3/4"
3/8"	CM3F2	1/4" - 18 NPTF	acero	1.34	34.0	0.72	18.3	5/8"
	CM3F2-B	1/4" - 18 NPTF	latón	1.34	34.0	0.72	18.3	5/8"
	CM3F3	3/8" - 18 NPTF	acero	1.34	34.0	0.87	22.1	3/4"
	CM3F3-B	3/8" - 18 NPTF	latón	1.34	34.0	0.87	22.1	3/4"
1/2"	CM4F4-B	1/2" - 14 NPTF	latón	1.69	42.9	1.16	29.5	1"
	CM4F6-B	3/4" - 14 NPTF	latón	1.69	42.9	1.37	34.8	1-3/16"

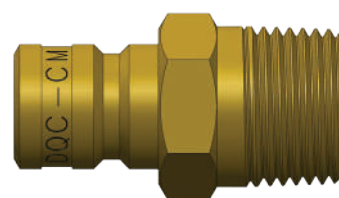
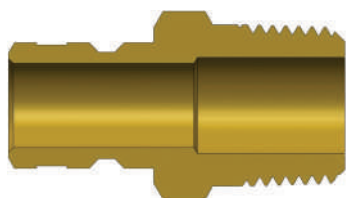

Medida	Serie-CM Niple Intercambio Molde Industrial (Roscas Macho)							
	Detalle			Medida		DE Máximo		Hex pulg
	# Parte	Roscas	Material	pulg	mm	pulg	mm	
1/4"	CM2M1-B	1/8" - 27 NPTF	latón	1.00	25.4	0.65	16.5	9/16"
	CM2M2-B	1/4" - 18 NPTF	latón	1.26	32.0	0.65	16.5	9/16"
	CM2M3-B	3/8" - 18 NPTF	latón	1.20	30.5	0.79	20.1	11/16"
3/8"	CM3M2-B	1/4" - 18 NPTF	latón	1.37	34.8	0.65	16.5	9/16"
	CM3M3-B	3/8" - 18 NPTF	latón	1.43	36.3	0.79	20.1	11/16"
	CM3M4-B	1/2" - 14 NPTF	latón	1.58	40.1	1.01	25.7	7/8"
1/2"	CM4M4-B	1/2" - 14 NPTF	latón	1.69	42.9	1.01	25.7	7/8"
	CM4M6-B	3/4" - 14 NPTF	latón	1.79	45.5	1.23	31.2	1-1/16"

Coples Hidráulicos: Serie-CM



Medida	Serie-CM Niple Extensión Intercambio Molde Industrial (Roscas Macho)							
	Detalle			Medida		DE Máximo		Hex pulg
	# Parte	Roscas	Material	pulg	mm	pulg	mm	
1/4"	CM2M1-B-L2.5	1/8" - 27 NPTF	latón	2.50	63.5	0.51	13.0	7/16"
	CM2M1-B-L4	1/8" - 27 NPTF	latón	4.00	101.6	0.51	13.0	7/16"
	CM2M1-B-L5.5	1/8" - 27 NPTF	latón	5.50	139.7	0.51	13.0	7/16"
	CM2M2-B-L2.5	1/4" - 18 NPTF	latón	2.50	63.5	0.65	16.5	9/16"
	CM2M2-B-L4	1/4" - 18 NPTF	latón	4.00	101.6	0.65	16.5	9/16"
	CM2M2-B-L5.5	1/4" - 18 NPTF	latón	5.50	139.7	0.65	16.5	9/16"
	CM2M2-B-L7	1/4" - 18 NPTF	latón	7.00	177.8	0.65	16.5	9/16"
3/8"	CM3M1-B-L2.5	1/8" - 27 NPTF	latón	2.50	63.5	0.65	16.5	9/16"
	CM3M1-B-L4	1/8" - 27 NPTF	latón	4.00	101.6	0.65	16.5	9/16"
	CM3M1-B-L5.5	1/8" - 27 NPTF	latón	5.50	139.7	0.65	16.5	9/16"
	CM3M1-B-L7	1/8" - 27 NPTF	latón	7.00	177.8	0.65	16.5	9/16"
	CM3M2-B-L2.5	1/4" - 18 NPTF	latón	2.50	63.5	0.65	16.5	9/16"
	CM3M2-B-L4	1/4" - 18 NPTF	latón	4.00	101.6	0.65	16.5	9/16"
	CM3M2-B-L5.5	1/4" - 18 NPTF	latón	5.50	139.7	0.65	16.5	9/16"
	CM3M2-B-L7	1/4" - 18 NPTF	latón	7.00	177.8	0.65	16.5	9/16"
	CM3M2-B-L8.5	1/4" - 18 NPTF	latón	8.50	215.9	0.65	16.5	9/16"
	CM3M2-B-L11.5	1/4" - 18 NPTF	latón	11.50	292.1	0.65	16.5	9/16"

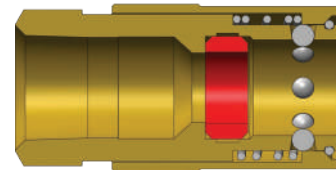

Medida	Serie-CM Cople sin Válvula Intercambio Molde Industrial (Roscas Hembra)							
	Detalle			Medida		DE Máximo		Hex pulg
	# Parte	Roscas	Material	pulg	mm	pulg	mm	
1/4"	2CMF1-B-E	1/8" - 27 NPTF	latón	1.35	34.3	0.69	17.5	9/16"
	2CMF2-B-E	1/4" - 18 NPTF	latón	1.35	34.3	0.79	20.1	11/16"
3/8"	3CMF2-B-E	1/4" - 18 NPTF	latón	1.84	46.7	0.95	24.1	3/4"
	3CMF3-B-E	3/8" - 18 NPTF	latón	1.84	46.7	1.01	25.7	7/8"
1/2"	4CMF4-B-E	1/2" - 14 NPTF	latón	2.02	51.3	1.24	31.5	1-1/8"

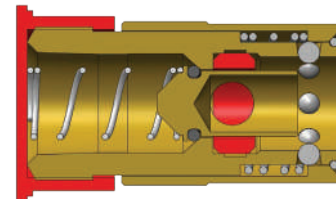
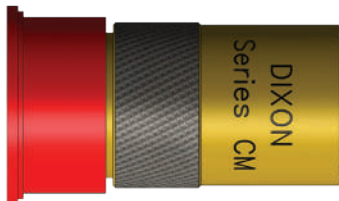

Medida	Serie-CM Cople con Válvula Intercambio Molde Industrial (Roscas Hembra)							
	Detalle			Medida		DE Máximo		Hex pulg
	# Parte	Roscas	Material	pulg	mm	pulg	mm	
1/4"	2CMF1-B	1/8" - 27 NPTF	latón	1.35	34.3	0.69	17.5	9/16"
3/8"	3CMF2-B	1/4" - 18 NPTF	latón	1.84	46.7	0.95	24.1	3/4"

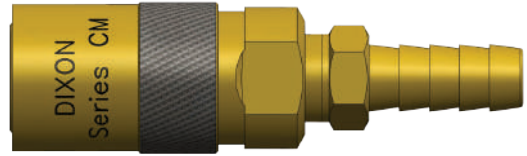
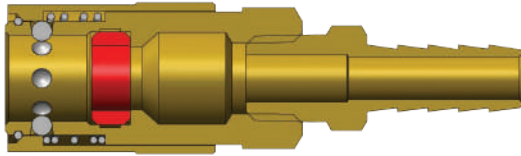

Serie-CM Cople sin Válvula Intercambio Molde Industrial (Barba para Manguera)

Medida	Detalle			Medida		DE Máximo		Hex pulg
	# Parte	DI Manguera	Material	pulg	mm	pulg	mm	
1/4"	2CMS2-B-E	1/4"	latón	2.11	53.6	0.69	17.5	-
	2CMS2.5-B-E	5/16"	latón	2.10	53.3	0.69	17.5	-
	2CMS3-B-E	3/8"	latón	2.10	53.3	0.69	17.5	-
3/8"	3CMS3-B-E	3/8"	latón	2.55	64.8	0.95	24.1	-
	3CMS4-B-E	1/2"	latón	2.55	64.8	0.95	24.1	-
1/2"	4CMS4-B-E	1/2"	latón	2.98	75.7	1.18	30.0	-
	4CMS6-B-E	3/4"	latón	2.98	75.7	1.18	30.0	-

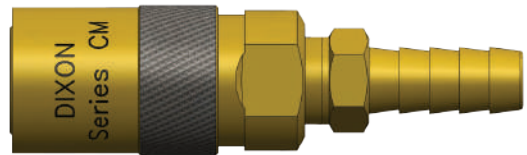
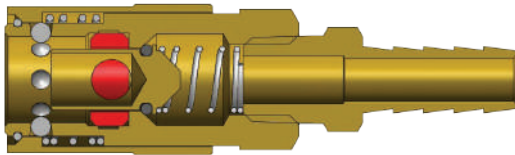

Serie-CM Cople con Válvula Intercambio Molde Industrial (Barba para Manguera)

Medida	Detalle			Medida		DE Máximo		Hex pulg
	# Parte	DI Manguera	Material	pulg	mm	pulg	mm	
1/4"	2CMS2-B	1/4"	latón	2.66	67.6	0.69	17.5	-
	2CMS2.5-B	5/16"	latón	2.66	67.6	0.69	17.5	-
	2CMS3-B	3/8"	latón	2.66	67.6	0.69	17.5	-
3/8"	3CMS3-B	3/8"	latón	3.30	83.8	0.95	24.1	-
	3CMS4-B	1/2"	latón	3.28	83.3	0.95	24.1	-

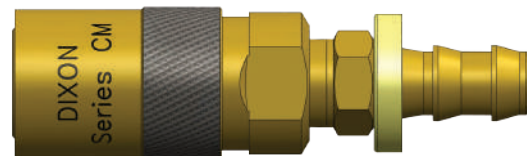
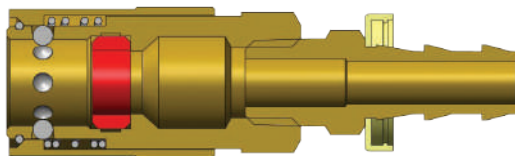

Serie-CM Cople sin Válvula Intercambio Molde Industria (Barbas Push-Loc)

Medida	Detalle			Medida		DE Máximo		Hex pulg
	# Parte	DI Manguera	Material	pulg	mm	pulg	mm	
1/4"	2CMB2-B-E	1/4"	latón	2.08	52.8	0.69	17.5	-
	2CMB3-B-E	3/8"	latón	2.08	52.8	0.69	17.5	-
3/8"	3CMB3-B-E	3/8"	latón	2.53	64.3	0.95	24.1	-
	3CMB4-B-E	1/2"	latón	2.69	68.3	0.95	24.1	-
1/2"	4CMB4-B-E	1/2"	latón	3.12	79.2	1.18	30.0	-
	4CMB6-B-E	3/4"	latón	3.12	79.2	1.18	30.0	-

Coples Hidráulicos: Serie-CM

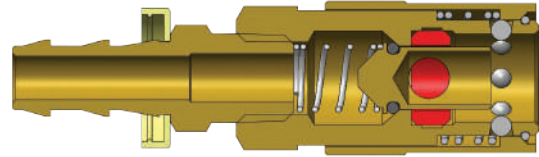
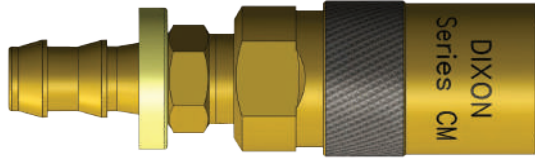

Serie-CM Cople con Válvula Intercambio Molde Industrial (Barba Push-Loc)

Medida	Detalle			Medida		DE Máximo		Hex pulg
	# Parte	DI Manguera	Material	pulg	mm	pulg	mm	
1/4"	2CMB2-B	1/4"	latón	2.64	67.1	0.69	17.5	-
	2CMB3-B	3/8"	latón	2.67	67.8	0.69	17.5	-
3/8"	3CMB3-B	3/8"	latón	3.28	83.3	0.95	24.1	-
	3CMB4-B	1/2"	latón	3.44	87.4	0.95	24.1	-

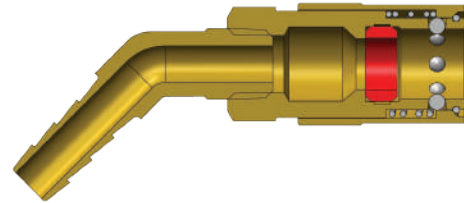
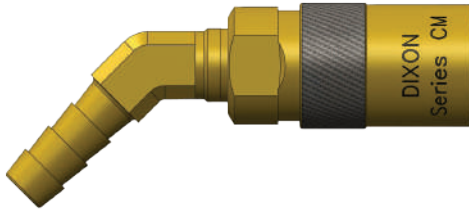

Serie-CM Cople sin Válvula Intercambio Molde Industrial (45° Barba para Manguera)

Medida	Detalle			Medida		DE Máximo		Hex pulg
	# Parte	DI Manguera	Material	pulg	mm	pulg	mm	
1/4"	2CM4S2-B-E	1/4"	latón	2.87	72.9	0.69	17.5	-
	2CM4S2.5-B-E	5/16"	latón	2.89	73.4	0.69	17.5	-
	2CM4S3-B-E	3/8"	latón	2.91	73.9	0.69	17.5	-
3/8"	3CM4S3-B-E	3/8"	latón	3.83	97.3	0.95	24.1	-
	3CM4S4-B-E	1/2"	latón	3.86	98.0	0.95	24.1	-
1/2"	4CM4S4-B-E	1/2"	latón	4.18	106.2	1.18	30.0	-
	4CM4S6-B-E	3/4"	latón	4.56	115.8	1.18	30.0	-

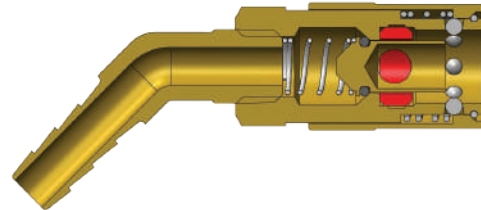
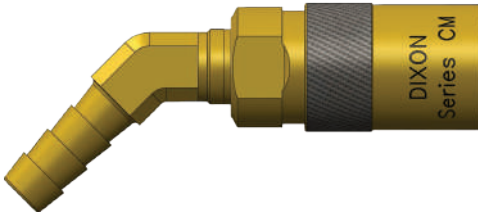

Serie-CM Cople con Válvula Intercambio Molde Industrial (45° Barba para Manguera)

Medida	Detalle			Medida		DE Máximo		Hex pulg
	# Parte	DI Manguera	Material	pulg	mm	pulg	mm	
1/4"	2CM4S2-B	1/4"	latón	2.87	72.9	0.69	17.5	-
	2CM4S2.5-B	5/16"	latón	2.89	73.4	0.69	17.5	-
	2CM4S3-B	3/8"	latón	2.91	73.9	0.69	17.5	-
3/8"	3CM4S3-B	3/8"	latón	3.83	97.3	0.95	24.1	-
	3CM4S4-B	1/2"	latón	3.86	98.0	0.95	24.1	-

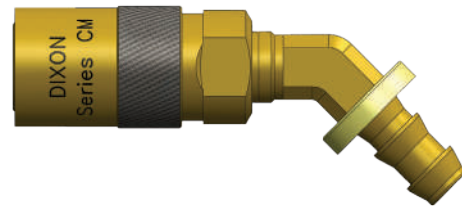
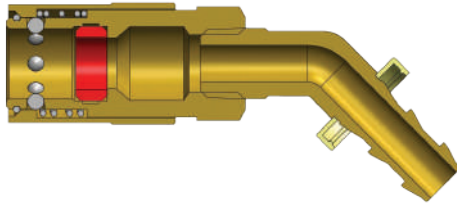

Serie-CM Cople sin Válvula Intercambio Molde Industrial (45° Barba Push-Loc)

Medida	Detalle			Medida		DE Máximo		Hex pulg
	# Parte	DI Manguera	Material	pulg	mm	pulg	mm	
1/4"	2CM4B2-B-E	1/4"	latón	2.86	72.6	0.69	17.5	-
	2CM4B3-B-E	3/8"	latón	2.92	74.2	0.69	17.5	-
3/8"	3CM4B3-B-E	3/8"	latón	3.82	97.0	0.95	24.1	-
	3CM4B4-B-E	1/2"	latón	3.98	101.1	0.95	24.1	-
1/2"	4CM4B4-B-E	1/2"	latón	4.28	108.7	1.18	30.0	-
	4CM4B6-B-E	3/4"	latón	4.56	115.8	1.18	30.0	-

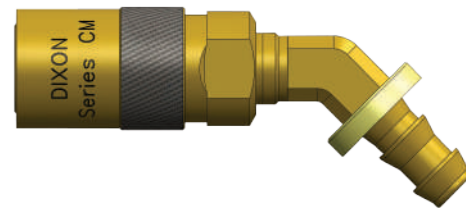
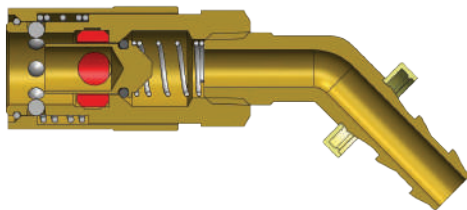

Serie-CM Cople con Válvula Intercambio Molde Industrial (45° Barba Push-Loc)

Medida	Detalle			Medida		DE Máximo		Hex pulg
	# Parte	DI Manguera	Material	pulg	mm	pulg	mm	
1/4"	2CM4B2-B	1/4"	latón	2.86	72.6	0.69	17.5	-
	2CM4B3-B	3/8"	latón	2.92	74.2	0.69	17.5	-
3/8"	3CM4B3-B	3/8"	latón	3.82	97.0	0.95	24.1	-
	3CM4B4-B	1/2"	latón	3.98	101.1	0.95	24.1	-

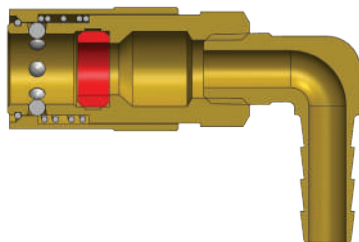

Serie-CM Cople sin Válvula Intercambio Molde Industrial (90° Barba para Manguera)

Medida	Detalle			Medida		DE Máximo		Hex pulg
	# Parte	DI Manguera	Material	pulg	mm	pulg	mm	
1/4"	2CM9S2-B-E	1/4"	latón	1.98	50.3	0.69	17.5	-
	2CM9S2.5-B-E	5/16"	latón	1.98	50.3	0.69	17.5	-
	2CM9S3-B-E	3/8"	latón	2.17	55.1	0.69	17.5	-
3/8"	3CM9S3-B-E	3/8"	latón	2.84	72.1	0.95	24.1	-
	3CM9S4-B-E	1/2"	latón	2.85	72.4	0.95	24.1	-
1/2"	4CM9S4-B-E	1/2"	latón	3.50	88.9	1.18	30.0	-
	4CM9S6-B-E	3/4"	latón	3.50	88.9	1.18	30.0	-

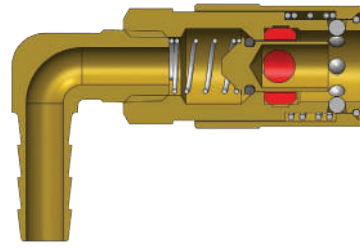

Serie-CM Cople con Válvula Intercambio Molde Industrial (90° Barba para Manguera)

Medida	Detalle			Medida		DE Máximo		Hex pulg
	# Parte	DI Manguera	Material	pulg	mm	pulg	mm	
1/4"	2CM9S2-B	1/4"	latón	1.98	50.3	0.69	17.5	-
	2CM9S2.5-B	5/16"	latón	1.98	50.3	0.69	17.5	-
	2CM9S3-B	3/8"	latón	2.17	55.1	0.69	17.5	-
3/8"	3CM9S3-B	3/8"	latón	2.84	72.1	0.95	24.1	-
	3CM9S4-B	1/2"	latón	2.85	72.4	0.95	24.1	-

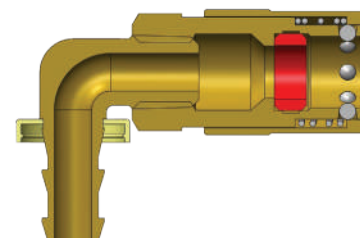
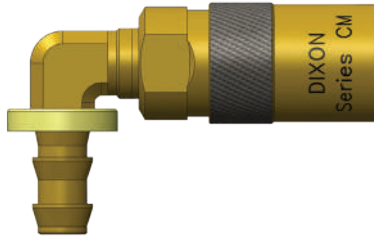

Serie-CM Cople sin Válvula Intercambio Molde Industrial (90° Barba Push-Loc)

Medida	Detalle			Medida		DE Máximo		Hex pulg
	# Parte	DI Manguera	Material	pulg	mm	pulg	mm	
1/4"	2CM9B2-B-E	1/4"	latón	2.07	52.6	0.69	17.5	-
	2CM9B3-B-E	3/8"	latón	2.17	55.1	0.69	17.5	-
3/8"	3CM9B3-B-E	3/8"	latón	2.93	74.4	0.95	24.1	-
	3CM9B4-B-E	1/2"	latón	2.98	75.7	0.95	24.1	-
1/2"	4CM9B4-B-E	1/2"	latón	3.50	88.9	1.18	30.0	-
	4CM9B6-B-E	3/4"	latón	3.50	88.9	1.18	30.0	-

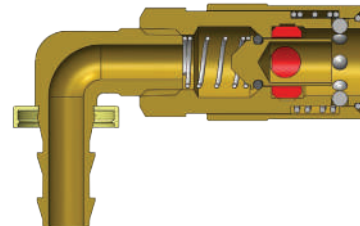
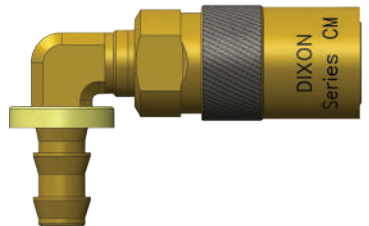

Serie-CM Cople con Válvula Intercambio Molde Industrial (90° Barba Push-Loc)

Medida	Detalle			Medida		DE Máximo		Hex pulg
	# Parte	DI Manguera	Material	pulg	mm	pulg	mm	
1/4"	2CM9B2-B	1/4"	latón	2.07	52.6	0.69	17.5	-
	2CM9B3-B	3/8"	latón	2.17	55.1	0.69	17.5	-
3/8"	3CM9B3-B	3/8"	latón	2.93	74.4	0.95	24.1	-
	3CM9B4-B	1/2"	latón	2.98	75.7	0.95	24.1	-

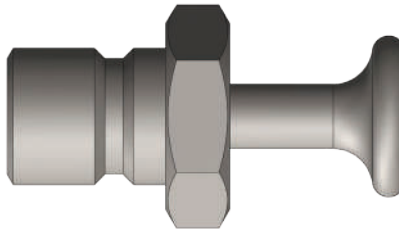

Medida	Serie-CM Tapón Rígido para Cople		
	Detalle		
	# Parte	Cuerda	Cuerpo
1/4"	2CMPC-B	N/A	latón
3/8"	3CMPC-B	N/A	latón
1/2"	4CMPC-B	N/A	latón

Medida	Serie-CM Kit de Sellos para Cople Intercambio Molde Industrial			
	Detalle			Contenido de Kit de Sellos
	# Parte	Estilo de Cople	Material de Sello	
1/4"	2CM-SKIT	Todos	Silicón	Sello de Cuerpo
3/8"	3CM-SKIT	Todos	Silicón	Sello de Cuerpo
1/2"	4CM-SKIT	Todos	Silicón	Sello de Cuerpo

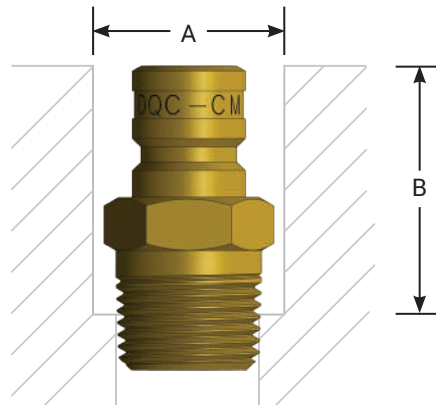

Los puertos están diseñados para proteger el niple macho roscado, permitiendo al niple ser montado debajo de la superficie, facilitando el almacenamiento y el manejo de moldes. Los niples macho roscados Dixon están construidos con latón resistente para maximizar la longevidad en la mayoría de los ambientes húmedos.

Medida	Detalle		Dimension A	Dimension B
	# Parte	Roscas		
1/4"	CM2M1-B	1/8" - 27 NPTF	17.5 mm (0.69")	17.5 mm (0.69")
	CM2M2-B	1/4" - 18 NPTF	21.3 mm (0.84")	23.9 mm (0.94")
	CM2M3-B	3/8" - 18 NPTF	25.4 mm (1.00")	24.6 mm (0.97")
3/8"	CM3M2-B	1/4" - 18 NPTF	17.5 mm (0.69")	23.9 mm (0.94")
	CM3M3-B	3/8" - 18 NPTF	21.3 mm (0.84")	28.7 mm (1.13")
	CM3M4-B	1/2" - 14 NPTF	25.4 mm (1.00")	31.8 mm (1.25")
1/2"	CM4M4-B	1/2" - 14 NPTF	31.8 mm (1.25")	38.1 mm (1.50")
	CM4M6-B	3/4" - 14 NPTF	38.1 mm (1.50")	39.6 mm (1.56")

Coples para Prevención de Reventón Dixon

Aplicación

- Diseñado específicamente para sistemas de prevención de reventón en equipos de perforación

Características

- Probado con fuego y certificado Lloyd a **1300°F (700°C)** de acuerdo con API 16D, certificados bajo pedido.
- Certificado a una presión de prueba de **5,000 PSI**
- Componentes y sellos externos pintados de polvo rojo para fácil identificación de servicio BOP.
- Los sellos críticos son de FKM

Oferta de Producto

- Serie VEP-BOP. (pg. 140)
 - Intercambio cara plana roscable
 - 3/8" a 1-1/2" en acero
- Serie H-BOP. (pg. 80)
 - Intercambio ISO-B
 - 3/8" a 1" en acero y a.i. 316
- Serie WS-BOP. (pg. 153)
 - El mismo mecanismo de tuerca que conoces solo con componentes rojos
 - 3/4" a 2" en acero y a.i. 316



# Parte	# Página	# Parte	# Página	# Parte	# Página	# Parte	# Página
10BOP-SKIT	152	12BOP-SKIT	152	12WSFH12	150	1BRM1-B-7	64
10CVVBF10	159	12E-SKIT	169	12WSFP12	150	1BRM2-B-7	64
10CVVDP	161	12EF12-B	165	12WSOF12	148	1BRS1.25-B-7	64
10CVVF10	159	12EF12-S	165	140030-10	111	1BRS1.86-B-7	64
10E-SKIT	169	12EM12-B	167	140030-12	111	1BRS2.83-B-7	64
10EF10-B	165	12H-BRKIT	79	140030-16	111	1EF1-B	165
10EF10-S	165	12H-RKIT	79	140032-10	111	1EF1-S	165
10EM10-B	167	12H-SKIT	78	140032-12	111	1EM1-B	167
10H-BRKIT	79	12H-SRKIT	79	140032-16	111	1EM1-S	167
10H-RKIT	79	12H-SSRKIT	79	16BOP-SKIT	152	1H-SKIT	78
10H-SKIT	78	12HBF12	73	16E-SKIT	169	1HDP	108, 77
10H-SRKIT	79	12HBF12-B	73	16EF16-B	165	1HF1	71
10H-SSRKIT	79	12HBF12-S	73	16EF16-S	165	1HF1-B	71
10HBF10	73	12HBF12-SS	73	16EM16-B	167	1HF1-S	71
10HBF10-B	73	12HDP-A	77	16HTBF16	119	1HF1-SS	71
10HBF10-S	73	12HF10	73	16HTF16	119	1HOF2	71
10HBF10-SS	73	12HF10-B	73	16HTOF16	119	1PDF1	133
10HF10	73	12HF10-S	73	16K-SKIT	90	1PDF2	133
10HF10-B	73	12HF10-SS	73	16KBF16	87	1PDM2	134
10HF10-S	73	12HF12	73	16KDP-A	90	20HDP-A	77
10HF10-SS	73	12HF12-B	73	16KF16	87	20HF16	73
10K-SKIT	90	12HF12-S	73	16ST-SKIT	132	20HF16-B	73
10KBF10	87	12HF12-SS	73	16STBF12	129	20HF20	73
10KDP-A	90	12HOF10	73	16STBF16	129	2AGF2	73
10KF10	87	12HOF12	73	16STDP-A	131	2AE2-B	67
10V-SKIT	110	12HTBF12	119	16STF12	129	2AF1-B	65
10VBF10	100	12HTF12	119	16STF16	129	2AF2-B	65
10VBF10-B	100	12HTOF12	119	16STF16-SS	129	2AGDP	94
10VBF10-B-E	105	12K-SKIT	90	16STOF12	129	2AGF2	92
10VBF10-E	105	12KBF12	87	16STOF16	129	2AGF2-PV	92
10VBF10-SS	100	12KDP-A	90	16V-SKIT	110	2AM1-B	66
10VBF10-SS-E	105	12KF12	87	16VBF16	100	2AM2-B	66
10VDP-A	109	12V-SKIT	110	16VBF16-B	100	2AS2-B	66
10VEPBF10	136	12VBF12	100	16VBF16-SS	100	2CJBF2-B	39
10VEPDP-A	139	12VBF12-B	100	16VDP-A	109	2CJBF3-B	39
10VEPF10	136	12VBF12-SS	100	16VEPBF16	136	2CJBM2-B	40
10VEPF10-BOP	141	12VDP-A	109	16VEPDP-A	139	2CJBM3-B	40
10VEPFH10	138	12VEPBF12	136	16VEPF16	136	2CJF2-B	39
10VEPPF10	138	12VEPDP-A	139	16VEPOF16	136	2CJF3-B	39
10VEPOF10	136	12VEPF12	136	16VF16	100	2CJM2-B	40
10VF10	100	12VEPF12-BOP	141	16VF16-B	100	2CJM3-B	40
10VF10-B	100	12VEPFH12	138	16VF16-B-E	105	2CM-SKIT	179
10VF10-B-E	105	12VEPPF12	138	16VF16-E	105	2CM4B2-B	177
10VF10-E	105	12VEPOF12	136	16VF16-SS	100	2CM4B2-B-E	177
10VF10-SS	100	12VF12	100	16VF16-SS-E	105	2CM4B3-B	177
10VF10-SS-E	105	12VF12-B	100	16VM16	102	2CM4B3-B-E	177
10VJM10	104	12VF12-B-E	105	16VM16-B	102	2CM4S2-B	176
10VM10	102	12VF12-E	105	16VM16-E	107	2CM4S2-B-E	176
10VM10-B	102	12VF12-SS	100	16VM16-SS	102	2CM4S2.5-B	176
10VM10-E	107	12VF12-SS-E	105	16VM16-SS-E	107	2CM4S2.5-B-E	176
10VM10-SS	102	12VM12	102	16WS-RKIT	152	2CM4S3-B	176
10VM10-SS-E	107	12VM12-B	102	16WS-SKIT	152	2CM4S3-B-E	176
10VOF10	100	12VM12-E	107	16WSBF16	148	2CM9B2-B	178
10W-RKIT-V2	146	12VM12-SS	102	16WSBF16-SS	148	2CM9B2-B-E	178
10WBF10-B	144	12VM12-SS-E	107	16WSDP-A	151	2CM9B3-B	178
10WBF10-B-HN	144	12VOF12	100	16WSF16	148	2CM9B3-B-E	178
10WDP	146	12W-RKIT-V2	146	16WSF16-BOP	154	2CM9S2-B	178
10WF10-B	144	12WBF12-B	144	16WSF16-SS	148	2CM9S2-B-E	177
10WF10-B-HN	144	12WBF12-B-HN	144	16WSF16-SS-BOP	154	2CM9S2.5-B	178
10WS-RKIT	152	12WDP	146	16WSFH16	150	2CM9S2.5-B-E	177
10WS-SKIT	152	12WF12-B	144	16WSFP16	150	2CM9S3-B	178
10WSBF10	148	12WF12-B-HN	144	16WSOF16	148	2CM9S3-B-E	177
10WSBF10-SS	148	12WS-RKIT	152	1AF1-B	65	2CMB2-B	176
10WSDP-A	151	12WS-SKIT	152	1AM1-B	66	2CMB2-B-E	175
10WSF10	148	12WSBF12	148	1AS1-B	66	2CMB3-B	176
10WSF10-BOP	154	12WSBF12-SS	148	1BRBF1-B-7	63	2CMB3-B-E	175
10WSF10-SS	148	12WSDP-A	151	1BRBF2-B-7	63	2CMF1-B	174
10WSF10-SS-BOP	154	12WSF12	148	1BRF1-B-7	63	2CMF1-B-E	174
10WSFH10	150	12WSF12-BOP	154	1BRF2-B-7	63	2CMF2-B-E	174
10WSFP10	150	12WSF12-SS	148	1BRGM1-B-7	64	2CMPC-B	179
10WSOF10	148	12WSF12-SS-BOP	154	1BRGM2-B-7	64	2CMS2-B	175

Índice Alfanumérico de Productos

# Parte	# Página	# Parte	# Página	# Parte	# Página	# Parte	# Página
2CMS2-B-E.....	175	2H-SSRKIT.....	79	2ST-SKIT.....	132	3CM4S3-B-E.....	176
2CMS2.5-B.....	175	2HBF2.....	71	2STBF2.....	128	3CM4S4-B.....	176
2CMS2.5-B-E.....	175	2HBF2-B.....	71	2STBF2-SS.....	128	3CM4S4-B-E.....	176
2CMS3-B.....	175	2HBF2-S.....	71	2STDP-A.....	131	3CM9B3-B.....	178
2CMS3-B-E.....	175	2HBF2-SS.....	71	2STF2.....	128	3CM9B3-B-E.....	178
2CVVBF2.....	159	2HDP-A.....	77	2STF2-SS.....	128	3CM9B4-B.....	178
2CVVDP.....	161	2HDP-H2DC.....	77	2T-SKIT.....	157	3CM9B4-B-E.....	178
2CVVF2.....	159	2HF2.....	71	2TDP.....	157	3CM9S3-B.....	178
2CVVFM1415.....	159	2HF2-B.....	71	2TF2.....	156	3CM9S3-B-E.....	177
2DB2-B.....	27	2HF2-S.....	71	2TM2.....	156	3CM9S4-B.....	178
2DB3-B.....	27	2HF2-SS.....	71	2UB2-B.....	48	3CM9S4-B-E.....	177
2DBF2-B.....	21	2HOF3.....	71	2UB3-B.....	48	3CMB3-B.....	176
2DBF3-B.....	21	2HSBF2-B.....	83	2UF2-B.....	48	3CMB3-B-E.....	175
2DBM2-B.....	23	2HSBF2-S.....	83	2UF3-B.....	48	3CMB4-B.....	176
2DBM3-B.....	23	2HSF2-B.....	83	2UM2-B.....	48	3CMB4-B-E.....	175
2DE2-B.....	28	2HSF2-S.....	83	2UM3-B.....	48	3CMF2-B.....	174
2DF1-B.....	21	2HT-SKIT.....	121	2US2-B.....	48	3CMF2-B-E.....	174
2DF2-B.....	21	2HTBAND-B.....	115	2US3-B.....	48	3CMF3-B-E.....	174
2DF2-S.....	21	2HTBAND-G.....	115	2V-BRKIT.....	111	3CMPC-B.....	179
2DF3-B.....	21	2HTBAND-O.....	115	2V-RKIT.....	111	3CMS3-B.....	175
2DF3-S.....	21	2HTBAND-R.....	115	2V-SKIT.....	110	3CMS3-B-E.....	175
2DH2-B.....	28	2HTBAND-Y.....	115	2V-SSRKIT.....	111	3CMS4-B.....	175
2DK3-B.....	28	2HTBF2.....	116	2VBF2.....	98	3CMS4-B-E.....	175
2DL3-B.....	28	2HTDP.....	120	2VBF2-B.....	98	3CVVBF3.....	159
2DM1-B.....	23	2HTF2.....	116	2VBF2-B-E.....	105	3CVVDP.....	161
2DM2-B.....	23	2HTOF3.....	116	2VBF2-E.....	105	3CVVF3.....	159
2DM2-S.....	23	2JB2-B.....	34	2VBF2-SS.....	98	3CVVFM1615.....	159
2DM3-B.....	23	2JB3-B.....	34	2VBF2-SS-E.....	105	3DB3-B.....	27
2DM3-S.....	23	2JF1-B.....	31	2VDP-A.....	109	3DBF3-B.....	21
2DS2-B.....	26	2JF2-B.....	31	2VEPBF2.....	136	3DBM3-B.....	23
2DS2-S.....	26	2JF3-B.....	31	2VEPDP-A.....	139	3DF2-B.....	21
2DS3-B.....	26	2JM1-B.....	32	2VEPF2.....	136	3DF3-B.....	21
2DS3-S.....	26	2JM2-B.....	32	2VEPOF3.....	136	3DF3-S.....	21
2E-SKIT.....	169	2JM3-B.....	32	2VF1.....	98	3DF4-B.....	21
2EBF2-B.....	165	2JS2-B.....	33	2VF2.....	98	3DM2-B.....	23
2EF2-B.....	165	2JS3-B.....	33	2VF2-B.....	98	3DM3-B.....	23
2EF2-S.....	165	2K-SKIT.....	90	2VF2-B-E.....	105	3DM3-S.....	23
2EM2-B.....	167	2KBF2.....	86	2VF2-E.....	105	3DM4-B.....	23
2EM2-S.....	167	2KBF2-SS.....	86	2VF2-SS.....	98	3DS2-B.....	26
2ES2-B.....	168	2KDP-K2DC.....	89	2VF2-SS-E.....	105	3DS3-B.....	26
2FB2-B.....	28	2KF1.....	86	2VJM2.....	104	3DS3-S.....	26
2FB3-B.....	28	2KF2.....	86	2VM1.....	102	3DS4-B.....	26
2FBF1-B.....	21	2KF2-SS.....	86	2VM2.....	102	3E-SKIT.....	169
2FBF2-B.....	21	2KOF2.....	86	2VM2-B.....	102	3EBF3-B.....	165
2FBF3-B.....	21	2LF2-B.....	45	2VM2-B-E.....	107	3EF3-B.....	165
2FBM1-B.....	24	2LM2-B.....	46	2VM2-E.....	107	3EF3-S.....	165
2FBM2-B.....	24	2MF2-B.....	36	2VM2-SS.....	102	3EM3-B.....	167
2FBM3-B.....	24	2MF2-PL.....	35	2VM2-SS-E.....	107	3EM3-S.....	167
2FF1-B.....	21	2MF3-B.....	36	2VOF2.....	98	3ES3-B.....	168
2FF2.....	21	2MF3-PL.....	35	2WDP.....	146	3FB2.....	28
2FF2-B.....	21	2MM2-B.....	37	2WF1-B.....	144	3FB3.....	28
2FF2-S.....	21	2MM2-PL.....	36	2WF1-B-HN.....	144	3FB4.....	28
2FF3-B.....	21	2MM3-B.....	37	3AGDP.....	94	3FBF3.....	21
2FF3-S.....	21	2MM3-PL.....	36	3AGF3.....	92	3FBM3.....	24
2FM1-B.....	24	2MS2-B.....	38	3AGF3-PS.....	93	3FF2.....	21
2FM1-S.....	24	2MS2-PL.....	37	3AGF3-PV.....	92	3FF3.....	21
2FM2.....	24	2MS2.5-PL.....	37	3AGF3-PV-PS.....	93	3FF3-S.....	21
2FM2-B.....	24	2MS3-B.....	38	3CJBF3-B.....	39	3FF4.....	21
2FM2-S.....	24	2MS3-PL.....	37	3CJBF4-B.....	39	3FM2.....	24
2FM3-B.....	24	2NKBF2.....	61	3CJBM3-B.....	40	3FM3.....	24
2FM3-S.....	24	2NKBM2.....	62	3CJBM4-B.....	40	3FM3-S.....	24
2FS2.....	26	2NKF2.....	61	3CJF3-B.....	39	3FM4.....	24
2FS2-B.....	26	2NKM2.....	62	3CJF4-B.....	39	3FS2.....	26
2FS2-S.....	26	2NKS2.....	62	3CJM3-B.....	40	3FS3.....	26
2FS2.5-B.....	26	2SHDF2.....	42	3CJM4-B.....	40	3FS3-S.....	26
2FS3-B.....	26	2SHDF3.....	42	3CM-SKIT.....	179	3FS4.....	26
2FS3-S.....	26	2SHDM2.....	43	3CM4B3-B.....	177	3H-BRKIT.....	79
2H-BRKIT.....	79	2SHDM3.....	43	3CM4B3-B-E.....	177	3H-RKIT.....	79
2H-RKIT.....	79	2SHDS2.....	44	3CM4B4-B.....	177	3H-SKIT.....	78
2H-SKIT.....	78	2SHDS3.....	44	3CM4B4-B-E.....	177	3H-SRKIT.....	79
2H-SRKIT.....	79	2ST-BMK.....	132	3CM4S3-B.....	176	3H-SSRKIT.....	79

# Parte	# Página	# Parte	# Página	# Parte	# Página	# Parte	# Página
3HBF3	71	3STDP-A	131	4AGOF4	92	4H-BRKIT	79
3HBF3-B	71	3STF2	128	4AGOF4-PS	93	4H-RKIT	79
3HBF3-S	71	3STF3	128	4AGOF4-PV	92	4H-SKIT	78
3HBF3-SS	71	3STF3-SS	128	4AGOF4-PV-PS	93	4H-SRKIT	79
3HDP-A	77	3STF4	128	4AGOF5	92	4H-SSRKIT	79
3HDP-H3DC	77	3STF4-SS	128	4AGOF5-PS	93	4HBF4	71
3HF3	71	3T-SKIT	157	4AGOF5-PV	92	4HBF4-B	71
3HF3-B	71	3TDP	157	4AGOF5-PV-PS	93	4HBF4-S	71
3HF3-BOP	81	3TF3	156	4CM-SKIT	179	4HBF4-SS	71
3HF3-S	71	3TM3	156	4CM4B4-B-E	177	4HDP-A	77
3HF3-SS	71	3TM3-PV	156	4CM4B6-B-E	177	4HDP-H4DC	77
3HF3-SS-BOP	81	3TM3-SS	156	4CM4S4-B-E	176	4HF4	71
3HOF4	71	3TM3-SS-PV	156	4CM4S6-B-E	176	4HF4-B	71
3HSBF3-B	83	3TR-SKIT	113	4CM9B4-B-E	178	4HF4-BOP	81
3HSBF3-S	83	3TRBF3	113	4CM9B6-B-E	178	4HF4-HV	75
3HSF3-B	83	3TRF3	113	4CM9S4-B-E	177	4HF4-S	71
3HSF3-S	83	3UF3-B	48	4CM9S6-B-E	177	4HF4-SS	71
3HT-SKIT	121	3UM3-B	48	4CMB4-B-E	175	4HF4-SS-BOP	81
3HTBAND-B	115	3US3-B	48	4CMB6-B-E	175	4HOF5	71
3HTBAND-G	115	3V-BRKIT	111	4CMF4-B-E	174	4HSBF4-B	83
3HTBAND-O	115	3V-RKIT	111	4CMPC-B	179	4HSBF4-S	83
3HTBAND-R	115	3V-SKIT	110	4CMS4-B-E	175	4HSF4-B	83
3HTBAND-Y	115	3V-SSRKIT	111	4CMS6-B-E	175	4HSF4-S	83
3HTBF3	116	3VBF3	98	4CVVBF4	159	4HT-SKIT	121
3HTBF3-SS	116	3VBF3-B	98	4CVVDP	161	4HT90F3	120
3HTBF4	116	3VBF3-B-E	105	4CVVF4	159	4HT90F4	120
3HTBF4-SS	116	3VBF3-E	105	4CVVFM1815	159	4HTAG4	126
3HTDP	120	3VBF3-SS	98	4CVVFM2215	159	4HTBAND-B	115
3HTF3	116	3VBF3-SS-E	105	4CVVOF4	159	4HTBAND-G	115
3HTF3-SS	116	3VDP-A	109	4CVVOF5	159	4HTBAND-O	115
3HTF4	116	3VDP-V3DC	108	4DB4-B	27	4HTBAND-R	115
3HTF4-SS	116	3VEPBF3	136	4DBF4-B	21	4HTBAND-Y	115
3HTM3	118	3VEPBF4	136	4DBM4-B	23	4HTBF4	116
3HTM4	118	3VEPDP-A	139	4DF3-B	21	4HTBF4-SS	116
3HTOF3	116	3VEPF3	136	4DF4-B	21	4HTBF6	116
3HTOF4	116	3VEPF3-BOP	141	4DF4-S	21	4HTBF6-SS	116
3HTOM3	118	3VEPF4	136	4DF6-B	21	4HTDP	120
3HTOM4	118	3VEPF4-BOP	141	4DM3-B	23	4HTF4	116
3JB2	34	3VEPOF4	136	4DM4-B	23	4HTF4-SS	116
3JB3	34	3VF3	98	4DM4-S	23	4HTF6	116
3JB4	34	3VF3-B	98	4DM6-B	23	4HTF6-SS	116
3JF2	31	3VF3-B-E	105	4DS3-B	26	4HTJB5	119
3JF3	31	3VF3-E	105	4DS4-B	26	4HTJB6	119
3JF4	31	3VF3-SS	98	4DS4-S	26	4HTM4	118
3JM2	32	3VF3-SS-E	105	4DS6-B	26	4HTOF4	116
3JM3	32	3VF4	98	4E-SKIT	169	4HTOF5	116
3JM4	32	3VJM3	104	4EA-SKIT	171	4HTOF6	116
3JS2	33	3VM3	102	4EAF3	171	4HTRB4	119
3JS3	33	3VM3-B	102	4EAF4	171	4HTRB5	119
3JS4	33	3VM3-B-E	107	4EBF4-B	165	4HTRB6	119
3K-SKIT	90	3VM3-E	107	4EF4-B	165	4HTZF4	125
3KBF3	86	3VM3-SS	102	4EF4-S	165	4HTZF6	125
3KBF3-SS	86	3VM3-SS-E	107	4EM4-B	167	4HTZOF4	125
3KDP-K3DC	108, 89	3VOF3	98	4EM4-S	167	4HTZOF5	125
3KF3	86	3WDP	146	4ES4-B	168	4HTZOF6	125
3KF3-SS	86	3WF2-B	144	4FB3	28, 34	4K-B-DP	89
3KOF3	86	3WF2-B-HN	144	4FB4	28, 34	4K-G-DP	89
3MF3-PL	35	3WF3-B	144	4FBF4	21	4K-O-DP	89
3MM3-PL	36	3WF3-B-HN	144	4FBM4	24	4K-R-DP	89
3MM4-PL	36	4.5TDDP-A	163	4FF3	21, 31	4K-SKIT	90
3MS3-PL	37	4AGBF4	92	4FF4	21, 31	4K-Y-DP	89
3N-SKIT	56	4AGBF4-PV	92	4FF4-S	21	4KBF4	86
3NBM4	52	4AGF4	92	4FF6	21, 31	4KBF4-SS	86
3NCS4	54	4AGF4-PS	93	4FM3	24, 32	4KDP	89
3NM4	52	4AGF4-PV	92	4FM4	24, 32	4KF4	86
3ST-BMK	132	4AGF4-PV-PS	93	4FM4-S	24	4KF4-SS	86
3ST-SKIT	132	4AGF6	92	4FM6	24, 32	4KF6	86
3STBF3	128	4AGF6-PS	93	4FS3	26, 33	4KOF4	86
3STBF3-SS	128	4AGF6-PV	92	4FS4	26, 33	4KOF5	86
3STBF4	128	4AGF6-PV-PS	93	4FS4-S	26	4N-SKIT	56
3STBF4-SS	128	4AGHT4	126	4FS6	26, 33	4N4N	56

Índice Alfanumérico de Productos

# Parte	# Página	# Parte	# Página	# Parte	# Página	# Parte	# Página
4NBF3	50	4PS6-B	60	5HTDP	120	6K-SKIT	90
4NBF4	50	4PS6-B-WF	60	5HTF6	116	6KBF6	87
4NBF4-B	50	4PS6-S	60	5HTF6-SS	116	6KBF6-SS	87
4NBF6	50	4PS6-S-WF	60	5HTOF5	116	6KDP-K6DC	89
4NBF6-B	50	4PS6-WF	60	5HTOF6	116	6KF6	87
4NBF8	50	4PS8	60	6AGDP	94	6KF6-SS	87
4NBF8-B	50	4PS8-B	60	6AGF6	92	6KOF6	87
4NBM3	52	4SHDF3	42	6AGF6-PS	93	6ST-BMK	132
4NBM4	52	4SHDF4	42	6AGF6-PV	92	6ST-SKIT	132
4NBM4-B	52	4SHDF6	42	6AGF6-PV-PS	93	6STBF6	128
4NBM6	52	4SHDM3	43	6BOP-SKIT	152	6STBF6-SS	128
4NBM6-B	52	4SHDM4	43	6CVVBF6	159	6STDP-A	131
4NBM8	52	4SHDS3	44	6CVVDP	161	6STF6	128
4NBM8-B	52	4SHDS4	44	6CVVF6	159	6STF6-SS	128
4NF3	50	4ST-BMK	132	6CVVFM2215	159	6STOF6	128
4NF3-B	50	4ST-SKIT	132	6DF4-B	21	6TR-SKIT	113
4NF4	50	4STBF4	128	6DF6-B	21	6TRBF6	113
4NF4-B	50	4STBF4-SS	128	6DF8-B	21	6TRF6	113
4NF6	50	4STDP-A	131	6DM4-B	23	6V-BRKIT	111
4NF6-B	50	4STF4	128	6DM6-B	23	6V-RKIT	111
4NF6-S	50	4STF4-SS	128	6DM8-B	23	6V-SKIT	110
4NF6-SS	50	4STOF4	128	6DS4-B	26	6V-SSRKIT	111
4NF8	50	4TDDP-A	163	6DS6-B	26	6VBF6	98
4NF8-B	50	4TDF4-SS	163	6DS8-B	26	6VBF6-B	98
4NF8-SS	50	4TDPF4.5-SS	163	6E-SKIT	169	6VBF6-B-E	105
4NM3	52	4TR-SKIT	113	6EBF6-B	165	6VBF6-E	105
4NM3-B	52	4TRBF4	113	6EF6-B	165	6VBF6-SS	98
4NM4	52	4TRF4	113	6EF6-S	165	6VBF6-SS-E	105
4NM4-B	52	4V-BRKIT	111	6EM6-B	167	6VDP-A	109
4NM6	52	4V-RKIT	111	6EM6-S	167	6VDP-V6DC	108
4NM6-B	52	4V-SKIT	110	6ES6-B	168	6VEPBF6	136
4NM6-S	52	4V-SSRKIT	111	6H-BRKIT	79	6VEPDP-A	139
4NM6-SS	52	4VBF4	98	6H-RKIT	79	6VEPF6	136
4NM8	52	4VBF4-B	98	6H-SKIT	78	6VEPF6-BOP	141
4NM8-B	52	4VBF4-B-E	105	6H-SRKIT	79	6VEPFH6	138
4NM8-SS	52	4VBF4-E	105	6H-SSRKIT	79	6VEPPF6	138
4NS3	54	4VBF4-SS	98	6HBF6	71	6VEPOF6	136
4NS3-B	54	4VBF4-SS-E	105	6HBF6-B	71	6VF6	98
4NS4	54	4VDP-A	109	6HBF6-S	71	6VF6-B	98
4NS4-B	54	4VEPBF4	136	6HBF6-SS	71	6VF6-B-E	105
4NS4-B-WF	56	4VEPBF6	136	6HDP-A	77	6VF6-E	105
4NS4-WF	56	4VEPDP-A	139	6HDP-H6DC	77	6VF6-SS	98
4NS6	54	4VEPF4	136	6HF6	71	6VF6-SS-E	105
4NS6-B	54	4VEPF4-BOP	141	6HF6-B	71	6VJM6	104
4NS6-B-WF	56	4VEPF6	136	6HF6-BOP	81	6VM6	102
4NS6-S	54	4VEPOF4	136	6HF6-S	71	6VM6-B	102
4NS6-SS	54	4VEPOF5	136	6HF6-SS	71	6VM6-B-E	107
4NS6-WF	56	4VEPOF6	136	6HF6-SS-BOP	81	6VM6-E	107
4NS8	54	4VF4	98	6HOF6	71	6VM6-SS	102
4NS8-B	54	4VF4-B	98	6HSBF6-B	83	6VM6-SS-E	107
4NS8-S	54	4VF4-B-E	105	6HSBF6-S	83	6VOF6	98
4NS8-SS	54	4VF4-E	105	6HSF6-B	83	6W-RKIT-V2	146
4P-SKIT	60	4VF4-SS	98	6HSF6-S	83	6WBF4-B	144
4PDC-A	59	4VF4-SS-E	105	6HT-SKIT	121	6WBF4-B-HN	144
4PF4	58	4VF6	98	6HTBAND-B	115	6WBF6-B	144
4PF6	58	4VJM4	104	6HTBAND-G	115	6WBF6-B-HN	144
4PF6-B	58	4VM4	102	6HTBAND-O	115	6WDP	146
4PF6-S	58	4VM4-B	102	6HTBAND-R	115	6WF4-B	144
4PM3	59	4VM4-B-E	107	6HTBAND-Y	115	6WF4-B-HN	144
4PM4	59	4VM4-E	107	6HTBF6	116	6WF6-B	144
4PM6	59	4VM4-SS	102	6HTBF6-SS	116	6WF6-B-HN	144
4PM6-9	59	4VM4-SS-E	107	6HTBF8	116	6WS-RKIT	152
4PM6-S	59	4VOF4	98	6HTBF8-SS	116	6WS-SKIT	152
4PM8	59	5HT-SKIT	121	6HTDP	120	6WSBF6	148
4PS3	60	5HTBAND-B	115	6HTF6	116	6WSBF6-SS	148
4PS4	60	5HTBAND-G	115	6HTF6-SS	116	6WSDP-A	151
4PS4-B	60	5HTBAND-O	115	6HTF8	116	6WSF4	148
4PS4-B-WF	60	5HTBAND-R	115	6HTF8-SS	116	6WSF4-BOP	154
4PS4-WF	60	5HTBAND-Y	115	6HTOF5	116	6WSF6	148
4PS6	60	5HTBF6	116	6HTOF6	116	6WSF6-BOP	154
4PS6-9	60	5HTBF6-SS	116	6HTOF8	116	6WSF6-SS	148

# Parte	# Página	# Parte	# Página	# Parte	# Página	# Parte	# Página
6WSF6-SS-BOP	154	8STDP-A	131	A2E2-B	67	CJ3M4-B	41
6WSFH6	150	8STDP-A-V2	131	A2F1-B	66	CM2F1	173
6WSFP6	150	8STF10	128	A2F2	66	CM2F1-B	173
6WSOF6	148	8STF10-SS	128	A2F2-B	66	CM2F2	173
8AGDP	94	8STF10-V2	129	A2M2	66	CM2F2-B	173
8AGF8	92	8STF8	128	A2M2-B	66	CM2F3	173
8AGF8-PV	92	8STF8-SS	128	A2S2	67	CM2F3-B	173
8BOP-SKIT	152	8STF8-V2	129	AG2DC	94	CM2M1-B	173, 179
8CVVBF8	159	8STOF10	128	AG2F2	93	CM2M1-B-L2.5	174
8CVVDP	161	8STOF8	128	AG2F2-PV	94	CM2M1-B-L4	174
8CVVF8	159	8TR-SKIT	113	AG3DC	94	CM2M1-B-L5.5	174
8E-SKIT	169	8TRBF8	113	AG3F3	93	CM2M2-B	173, 179
8EBF8-B	165	8TRF8	113	AG3F3-PV	94	CM2M2-B-L2.5	174
8EF8-B	165	8V-BRKIT	111	AG4BF4	93	CM2M2-B-L4	174
8EF8-S	165	8V-RKIT	111	AG4BF4-PV	94	CM2M2-B-L5.5	174
8EM8-B	167	8V-SKIT	110	AG4F4	93	CM2M2-B-L7	174
8EM8-S	167	8V-SSRKIT	111	AG4F4-PV	94	CM2M3-B	173, 179
8ES8-B	168	8VBF8	98	AG4F6	93	CM3F2	173
8H-BRKIT	79	8VBF8-B	98	AG4F6-PV	94	CM3F2-B	173
8H-RKIT	79	8VBF8-B-E	105	AG4OF4	93	CM3F3	173
8H-SKIT	78	8VBF8-E	105	AG4OF4-PV	94	CM3F3-B	173
8H-SSRKIT	79	8VBF8-SS	98	AG4OF5	93	CM3M1-B-L2.5	174
8H-SSRKIT	79	8VBF8-SS-E	105	AG4OF5-PV	94	CM3M1-B-L4	174
8HBF8	71	8VDP-A	109	AG6DC	94	CM3M1-B-L5.5	174
8HBF8-B	71	8VDP-V8DC	108	AG6F6	93	CM3M1-B-L7	174
8HBF8-S	71	8VEPBF8	136	AG6F6-PV	94	CM3M2-B	173, 179
8HBF8-SS	71	8VEPDP-A	139	AG8DC	94	CM3M2-B-L11.5	174
8HDP-A	77	8VEPF8	136	AG8F8	93	CM3M2-B-L2.5	174
8HDP-H8DC	77	8VEPF8-BOP	141	AG8F8-PV	94	CM3M2-B-L4	174
8HF8	71	8VEPF8-SS	136	BR1BF1-B-E-7	63	CM3M2-B-L5.5	174
8HF8-B	71	8VEPFH8	138	BR1BF2-B-E-7	63	CM3M2-B-L7	174
8HF8-BOP	81	8VEFPF8	138	BR1F1-B-E-7	63	CM3M2-B-L8.5	174
8HF8-S	71	8VEPOF8	136	BR1F2-B-E-7	63	CM3M3-B	173, 179
8HF8-SS	71	8VF8	98	BR1GM1-B-E-7	64	CM3M4-B	173, 179
8HF8-SS-BOP	81	8VF8-B	98	BR1GM2-B-E-7	64	CM4F4-B	173
8HOF8	71	8VF8-B-E	105	BR1M1-B-E-7	64	CM4F6-B	173
8HSBF8-B	83	8VF8-E	105	BR1M2-B-E-7	64	CM4M4-B	173, 179
8HSBF8-S	83	8VF8-SS	98	BR1S1.25-B-E-7	64	CM4M6-B	173, 179
8HSF8-B	83	8VF8-SS-E	105	BR1S1.86-B-E-7	64	CVV10BF10	160
8HSF8-S	83	8VJM8	104	BR1S2.83-B-E-7	64	CVV10DC	161
8HT-SKIT	121	8VM8	102	CJ2BF2-B	40	CVV10F10	160
8HTBAND-B	115	8VM8-B	102	CJ2BF2-LG	40	CVV2BF2	160
8HTBAND-G	115	8VM8-B-E	107	CJ2BF3-B	40	CVV2DC	161
8HTBAND-O	115	8VM8-E	107	CJ2BF3-LG	40	CVV2F2	160
8HTBAND-R	115	8VM8-SS	102	CJ2BM2-B	41	CVV2FM1415	160
8HTBAND-Y	115	8VM8-SS-E	107	CJ2BM2-LG	41	CVV3BF3	160
8HTBF10	116	8VOF8	98	CJ2BM3-B	41	CVV3DC	161
8HTBF10-SS	116	8W-RKIT-V2	146	CJ2BM3-LG	41	CVV3F3	160
8HTBF8	116	8WBF8-B	144	CJ2F2-B	40	CVV3FM1615	160
8HTBF8-SS	116	8WBF8-B-HN	144	CJ2F2-LG	40	CVV4BF4	160
8HTDP	120	8WDP	146	CJ2F3-B	40	CVV4DC	161
8HTF10	116	8WF8	144	CJ2F3-LG	40	CVV4F4	160
8HTF10-SS	116	8WF8-B	144	CJ2M2-B	41	CVV4FM1815	160
8HTF8	116	8WF8-B-HN	144	CJ2M2-LG	41	CVV4FM2215	160
8HTF8-SS	116	8WF8-HN	144	CJ2M3-B	41	CVV4OF4	160
8HTOF10	116	8WS-RKIT	152	CJ2M3-LG	41	CVV4OF5	160
8HTOF8	116	8WS-SKIT	152	CJ3BF3	40	CVV6BF6	160
8K-SKIT	90	8WSBF8	148	CJ3BF3-B	40	CVV6DC	161
8KBF8	87	8WSBF8-SS	148	CJ3BF4	40	CVV6F6	160
8KBF8-SS	87	8WSDP-A	151	CJ3BF4-B	40	CVV6FM2215	160
8KDP-K8DC	89	8WSF8	148	CJ3BM3	41	CVV8BF8	160
8KF8	87	8WSF8-BOP	154	CJ3BM3-B	41	CVV8DC	161
8KF8-SS	87	8WSF8-SS	148	CJ3BM4	41	CVV8F8	160
8KOF8	87	8WSF8-SS-BOP	154	CJ3BM4-B	41	D-4HF4-S-FNS	75
8ST-SKIT	132	8WSFH8	150	CJ3F3	40	D-4HF4-S-FSB	75
8ST-SKIT-V2	132	8WSFP8	150	CJ3F3-B	40	D-4HF4-SS-FNS	75
8STBF10	128	8WSOF8	148	CJ3F4	40	D-4HF4-SS-FSB	75
8STBF10-SS	128	A1F1-B	66	CJ3F4-B	40	D-H4F4-S	76
8STBF8	128	A1M1-B	66	CJ3M3	41	D-H4F4-SS	76
8STBF8-SS	128	A1S1-B	67	CJ3M3-B	41	D-H4F4-SV-8	76
8STBF8-V2	129	A2E2	67	CJ3M4	41	D2B2	28

Índice Alfanumérico de Productos

# Parte	# Página	# Parte	# Página	# Parte	# Página	# Parte	# Página
D2B2-B	28	D4S4-B	27	E8BF8-B	166	H20F16-B	74
D2B3	28	D4S4-S	27	E8F8	166	H20F20	74
D2BF2	22	D4S6	27	E8F8-B	166	H20F24	74
D2BF3	22	D4S6-B	27	E8F8-S	166	H2BF2	72
D2BM2	25	D6B6	28	E8M8	168	H2BF2-B	72
D2BM3	25	D6F4	22	E8M8-B	168	H2BF2-S	72
D2E2	28	D6F6	22	E8M8-S	168	H2BF2-SS	72
D2F1	22	D6F8	22	E8S8	169	H2DC-A	77
D2F2	22	D6M4	25	E8S8-B	169	H2F2	72
D2F2-B	22	D6M6	25	EA4F3	171	H2F2-B	72
D2F2-S	22	D6M8	25	EA4F4	171	H2F2-S	72
D2F3	22	D6S4	27	F-10-SKIT	78	H2F2-SS	72
D2F3-B	22	D6S6	27	F-10E-SKIT	169	H2M3	74
D2F3-S	22	D6S8	27	F-10V-SKIT	110	H2OF3	72
D2H2	28	E10F10	166	F-12E-SKIT	169	H3BF3	72
D2K3	28	E10F10-B	166	F-12H-SKIT	78	H3BF3-B	72
D2L3	28	E10F10-S	166	F-12V-SKIT	110	H3BF3-S	72
D2M1	25	E10M10	168	F-16E-SKIT	169	H3BF3-SS	72
D2M1-B	25	E10M10-B	168	F-16V-SKIT	110	H3DC-A	77
D2M1-S	25	E12F12	166	F-1H-SKIT	78	H3F3	72
D2M2	25	E12F12-B	166	F-2E-SKIT	169	H3F3-B	72
D2M2-B	25	E12F12-S	166	F-2H-SKIT	78	H3F3-BOP	81
D2M2-S	25	E12M12	168	F-2V-SKIT	110	H3F3-S	72
D2M3	25	E12M12-B	168	F-3E-SKIT	169	H3F3-SS	72
D2M3-B	25	E16F16	166	F-3H-SKIT	78	H3F3-SS-BOP	81
D2M3-S	25	E16F16-B	166	F-3V-SKIT	110	H3OF4	72
D2S2	27	E16F16-S	166	F-4E-SKIT	169	H4BF4	72
D2S2-B	27	E16M16	168	F-4EA-SKIT	171	H4BF4-B	72
D2S2-S	27	E16M16-B	168	F-4H-SKIT	78	H4BF4-S	72
D2S2.5	27	E1F1	166	F-4HF4-HV	75	H4BF4-SS	72
D2S3	27	E1F1-B	166	F-4N-SKIT	56	H4DC-A	77
D2S3-B	27	E1F1-S	166	F-4P-SKIT	60	H4F4	72
D2S3-S	27	E1M1	168	F-4V-SKIT	110	H4F4-B	72
D3B2	28	E1M1-B	168	F-6E-SKIT	169	H4F4-BOP	81
D3B3	28	E1M1-S	168	F-6H-SKIT	78	H4F4-HV	75
D3B4	28	E2BF2-B	166	F-6V-SKIT	110	H4F4-S	72
D3BF3	22	E2F2	166	F-8E-SKIT	169	H4F4-SS	72
D3BM3	25	E2F2-B	166	F-8H-SKIT	78	H4F4-SS-BOP	81
D3F2	22	E2F2-S	166	F-8V-SKIT	110	H4M6-S	74
D3F3	22	E2M2	168	F-H4F4-HV	75	H4OF5	72
D3F3-B	22	E2M2-B	168	H10BF10	74	H6BF6	72
D3F3-S	22	E2M2-S	168	H10BF10-B	74	H6BF6-B	72
D3F4	22	E2S2	169	H10BF10-S	74	H6BF6-S	72
D3M2	25	E2S2-B	169	H10BF10-SS	74	H6BF6-SS	72
D3M3	25	E3BF3-B	166	H10F10	74	H6DC-A	77
D3M3-B	25	E3F3	166	H10F10-B	74	H6F6	72
D3M3-S	25	E3F3-B	166	H10F10-S	74	H6F6-B	72
D3M4	25	E3F3-S	166	H10F10-SS	74	H6F6-BOP	81
D3S2	27	E3M3	168	H12BF12	74	H6F6-S	72
D3S3	27	E3M3-B	168	H12BF12-B	74	H6F6-SS	72
D3S3-B	27	E3M3-S	168	H12BF12-S	74	H6F6-SS-BOP	81
D3S3-S	27	E3S3	169	H12BF12-SS	74	H6OF6	72
D3S4	27	E3S3-B	169	H12DC-A	77	H8BF8	72
D4B4	28	E4BF4-B	166	H12F10	74	H8BF8-B	72
D4BF4	22	E4F4	166	H12F10-B	74	H8BF8-S	72
D4BM4	25	E4F4-B	166	H12F10-S	74	H8BF8-SS	72
D4F3	22	E4F4-S	166	H12F10-SS	74	H8DC-A	77
D4F4	22	E4M4	168	H12F12	74	H8F8	72
D4F4-B	22	E4M4-B	168	H12F12-B	74	H8F8-B	72
D4F4-S	22	E4M4-S	168	H12F12-S	74	H8F8-BOP	81
D4F6	22	E4S4	169	H12F12-SS	74	H8F8-S	72
D4F6-B	22	E4S4-B	169	H12OF10	74	H8F8-SS	72
D4M2	25	E6BF6-B	166	H12OF12	74	H8F8-SS-BOP	81
D4M3	25	E6F6	166	H1DC	134, 77	H8OF8	72
D4M4	25	E6F6-B	166	H1F1	72	HS2BF2	84
D4M4-B	25	E6F6-S	166	H1F1-B	72	HS2BF2-B	84
D4M4-S	25	E6M6	168	H1F1-S	72	HS2BF2-S	84
D4M6	25	E6M6-B	168	H1F1-SS	72	HS2F2	84
D4S3	27	E6M6-S	168	H10F2	72	HS2F2-B	84
D4S3-B	27	E6S6	169	H20DC-A	77	HS2F2-S	84
D4S4	27	E6S6-B	169	H20F16	74	HS3BF3	84

# Parte	# Página	# Parte	# Página	# Parte	# Página	# Parte	# Página
HS3BF3-B	84	HT4BF6-SS	117	HTE40F4	124	K4-B-DC	89
HS3BF3-S	84	HT4DC	120	HTE40F5	124	K4-G-DC	89
HS3F3	84	HT4F4	117	HTE40F6	124	K4-O-DC	89
HS3F3-B	84	HT4F4-SS	117	HTE5BF6	124	K4-R-DC	89
HS3F3-S	84	HT4F6	117	HTE5F6	124	K4-Y-DC	89
HS4BF4	84	HT4F6-SS	117	HTE5OF5	124	K4BF4	88
HS4BF4-B	84	HT4JB5	119	HTE5OF6	124	K4BF4-SS	88
HS4BF4-S	84	HT4JB6	119	HTE6BF6	124	K4DC	89
HS4F4	84	HT4M4	118	HTE6BF8	124	K4F4	88
HS4F4-B	84	HT4OF4	117	HTE6F6	124	K4F4-SS	88
HS4F4-S	84	HT4OF5	117	HTE6F8	124	K4F6	88
HS6BF6	84	HT4OF6	117	HTE6OF6	124	K4OF4	88
HS6BF6-B	84	HT4RB4	119	HTE6OF8	124	K4OF5	88
HS6BF6-S	84	HT4RB5	119	HTE8BF10	124	K6BF6	88
HS6F6	84	HT4RB6	119	HTE8BF8	124	K6BF6-SS	88
HS6F6-B	84	HT5-SKIT-V2	121	HTE8F10	124	K6F6	88
HS6F6-S	84	HT5BAND-B	115	HTE8F8	124	K6F6-SS	88
HS8BF8	84	HT5BAND-G	115	HTE8OF10	124	K6OF6	88
HS8BF8-B	84	HT5BAND-O	115	HTE8OF8	124	K8BF8	88
HS8BF8-S	84	HT5BAND-R	115	J2B2	34	K8BF8-SS	88
HS8F8	84	HT5BAND-Y	115	J2B3	34	K8F8	88
HS8F8-B	84	HT5BF6	117	J2F1	31	K8F8-SS	88
HS8F8-S	84	HT5BF6-SS	117	J2F2	31	K8OF8	88
HT12BF12	119	HT5DC	120	J2F2-B	31	L2F2	45
HT12F12	119	HT5F6	117	J2F3	31	L2M2	46
HT12OF12	119	HT5F6-SS	117	J2M1	32	M2B2	38
HT16BF16	119	HT5OF5	117	J2M2	32	M2F2	36
HT16F16	119	HT5OF6	117	J2M2-B	32	M2F2-B	36
HT16OF16	119	HT6-SKIT-V2	121	J2M3	32	M2F3	36
HT2-SKIT-V2	121	HT6BAND-B	115	J2S2	33	M2M1	37
HT2BAND-B	115	HT6BAND-G	115	J2S3	33	M2M2	37
HT2BAND-G	115	HT6BAND-O	115	J3B3	34	M2M2-B	37
HT2BAND-O	115	HT6BAND-R	115	J3F2	31	M2M3	37
HT2BAND-R	115	HT6BAND-Y	115	J3F3	31	M2S2	38
HT2BAND-Y	115	HT6BF6	117	J3F4	31	M2S3	38
HT2BF2	117	HT6BF6-SS	117	J3M2	32	M3F3	36
HT2DC	120	HT6BF8	117	J3M3	32	M3M3	37
HT2F2	117	HT6BF8-SS	117	J3M4	32	M3S3	38
HT2OF3	117	HT6DC	120	J3S2	33	N3BM4	53
HT3-SKIT-V2	121	HT6F6	117	J3S3	33	N3CS4	54
HT3BAND-B	115	HT6F6-SS	117	J3S4	33	N3M4	53
HT3BAND-G	115	HT6F8	117	J4B4	34	N4BF3	51
HT3BAND-O	115	HT6F8-SS	117	J4F3	31	N4BF4	51
HT3BAND-R	115	HT6OF5	117	J4F4	31	N4BF4-B	51
HT3BAND-Y	115	HT6OF6	117	J4F6	31	N4BF6	51
HT3BF3	117	HT6OF8	117	J4M3	32	N4BF6-B	51
HT3BF3-SS	117	HT8-SKIT-V2	121	J4M4	32	N4BF8	51
HT3BF4	117	HT8BAND-B	115	J4M6	32	N4BF8-B	51
HT3BF4-SS	117	HT8BAND-G	115	J4S3	33	N4BM3	53
HT3DC	120	HT8BAND-O	115	J4S4	33	N4BM4	53
HT3F3	117	HT8BAND-R	115	J4S6	33	N4BM4-B	53
HT3F3-SS	117	HT8BAND-Y	115	K10BF10	88	N4BM4-LS	53
HT3F4	117	HT8BF10	117	K10DC-A	90	N4BM6	53
HT3F4-SS	117	HT8BF10-SS	117	K10F10	88	N4BM6-B	53
HT3M3	118	HT8BF8	117	K12BF12	88	N4BM6-LS	53
HT3M4	118	HT8BF8-SS	117	K12DC-A	90	N4BM8	53
HT3OF3	117	HT8DC	120	K12F12	88	N4BM8-B	53
HT3OF4	117	HT8F10	117	K16BF16	88	N4DC	56
HT3OM3	118	HT8F10-SS	117	K16DC-A	90	N4DC-B	56
HT3OM4	118	HT8F8	117	K16F16	88	N4F3	51
HT4-SKIT-V2	121	HT8F8-SS	117	K2BF2	88	N4F3-B	51
HT49OF3	120	HT8OF10	117	K2BF2-SS	88	N4F4	51
HT49OF4	120	HT8OF8	117	K2F1	88	N4F4-B	51
HT4BAND-B	115	HTE3BF4	124	K2F2	88	N4F4-B-LS	51
HT4BAND-G	115	HTE3F3	124	K2F2-SS	88	N4F6	51
HT4BAND-O	115	HTE3F4	124	K2OF2	88	N4F6-B	51
HT4BAND-R	115	HTE3OF4	124	K3BF3	88	N4F6-B-LS	51
HT4BAND-Y	115	HTE4BF4	124	K3BF3-SS	88	N4F6-LS	51
HT4BF4	117	HTE4BF6	124	K3F3	88	N4F6-S	51
HT4BF4-SS	117	HTE4F4	124	K3F3-SS	88	N4F6-SS	51
HT4BF6	117	HTE4F6	124	K3OF3	88	N4F6-ZLS	51

Índice Alfanumérico de Productos

# Parte	# Página	# Parte	# Página	# Parte	# Página	# Parte	# Página
N4F8	51	P-6E-SKIT	169	SHD4S3	44	TR4BF4	113
N4F8-B	51	P-6H-SKIT	78	SHD4S4	44	TR4F4	113
N4F8-SS	51	P-6V-SKIT	110	ST16-SKIT	132	TR6BF6	113
N4M3	53	P-8E-SKIT	169	ST16BF12	131	TR6F6	113
N4M3-B	53	P-8H-SKIT	78	ST16BF16	131	TR8BF8	113
N4M4	53	P-8V-SKIT	110	ST16DC-A	131	TR8F8	113
N4M4-B	53	P4F3	58	ST16F12	131	V10BF10	101
N4M4-B-LS	53	P4F4	58	ST16F16	131	V10BF10-B	101
N4M4-LS	53	P4F4-B	58	ST16F16-SS	131	V10BF10-B-E	106
N4M6	53	P4F6	58	ST16OF12	131	V10BF10-E	106
N4M6-B	53	P4F6-9	58	ST16OF16	131	V10BF10-SS	101
N4M6-B-LS	53	P4F6-B	58	ST2-SKIT	132	V10BF10-SS-E	106
N4M6-LS	53	P4F6-S	58	ST2BF2	130	V10DC-A	109
N4M6-S	53	P4F8	58	ST2BF2-SS	130	V10F10	101
N4M6-S-LS	53	P4F8-B	58	ST2DC-A	131	V10F10-B	101
N4M6-SS	53	P4M3	59	ST2F2	130	V10F10-B-E	106
N4M6-ZLS	52	P4M4	59	ST2F2-SS	130	V10F10-E	106
N4M8	53	P4M4-B	59	ST3-SKIT	132	V10F10-SS	101
N4M8-B	53	P4M6	59	ST3BF3	130	V10F10-SS-E	106
N4M8-SS	53	P4M6-9	59	ST3BF3-SS	130	V10JM10	104
N4S3	54	P4M6-B	59	ST3BF4	130	V10M10	103
N4S3-B	54	P4M6-S	59	ST3BF4-SS	130	V10M10-B	103
N4S4	54	P4M8	59	ST3DC-A	131	V10M10-E	108
N4S4-B	54	P4M8-B	59	ST3F2	130	V10M10-SS	103
N4S4-B-LS	55	PD1F1	133	ST3F3	130	V10M10-SS-E	108
N4S4-B-LS-WF	55	PD1F2	133	ST3F3-SS	130	V10OF10	101
N4S4-B-WF	55	PD1M1	134	ST3F4	130	V12BF12	101
N4S4-LS	55	PD1M2	134	ST3F4-SS	130	V12BF12-B	101
N4S4-LS-WF	55	PD1OM2	134	ST4-SKIT	132	V12BF12-SS	101
N4S4-WF	55	PD1OM3	134	ST4BF4	130	V12DC-A	109
N4S6	54	SCVH10	69	ST4BF4-SS	130	V12F12	101
N4S6-B	54	SCVH12	69	ST4DC-A	131	V12F12-B	101
N4S6-B-LS	55	SCVH16	69	ST4F4	130	V12F12-B-E	106
N4S6-B-LS-WF	55	SCVH24	69	ST4F4-SS	130	V12F12-E	106
N4S6-B-WF	55	SCVH6	69	ST4OF4	130	V12F12-SS	101
N4S6-LS	55	SCVH8	69	ST6-SKIT	132	V12F12-SS-E	106
N4S6-LS-WF	55	SCVJ6	69	ST6BF6	130	V12M12	103
N4S6-S	54	SCVL10	69	ST6BF6-SS	130	V12M12-B	103
N4S6-S-LS	55	SCVL12	69	ST6DC-A	131	V12M12-E	108
N4S6-S-WF	55	SCVL16	69	ST6F6	130	V12M12-SS	103
N4S6-SS	54	SCVL2	69	ST6F6-SS	130	V12M12-SS-E	108
N4S6-WF	55	SCVL24	69	ST6OF6	130	V12OF12	101
N4S6-ZLS	55	SCVL3	69	ST8-SKIT	132	V16BF16	101
N4S8	54	SCVL6	69	ST8BF10	130	V16BF16-B	101
N4S8-B	54	SCVL8	69	ST8BF10-SS	130	V16BF16-SS	101
N4S8-S	54	SCVM10	69	ST8BF8	130	V16DC-A	109
N4S8-SS	54	SCVM12	69	ST8BF8-SS	130	V16F16	101
NK2BF2	61	SCVM16	69	ST8BF8-V2	131	V16F16-B	101
NK2BM2	62	SCVM3	69	ST8DC-A	131	V16F16-B-E	106
NK2F2	61	SCVM4	69	ST8DC-A-V2	131	V16F16-E	106
NK2M2	62	SCVM6	69	ST8F10	130	V16F16-SS	101
NK2S2	62	SCVM8	69	ST8F10-SS	130	V16F16-SS-E	106
P-10-SKIT	78	SCVR6	69	ST8F10-V2	131	V16M16	103
P-10E-SKIT	169	SCVS10	69	ST8F8	130	V16M16-B	103
P-10V-SKIT	110	SCVS12	69	ST8F8-SS	130	V16M16-E	108
P-12E-SKIT	169	SCVS16	69	ST8F8-V2	131	V16M16-SS	103
P-12H-SKIT	78	SCVS24	69	ST8OF10	130	V16M16-SS-E	108
P-12V-SKIT	110	SCVS3	69	ST8OF8	130	V2-BRKIT	111
P-16E-SKIT	169	SCVS4	69	T2DC	157	V2-RKIT	111
P-16V-SKIT	110	SCVS6	69	T2F2	156	V2-SSRKIT	111
P-1H-SKIT	78	SCVS8	69	T3DC	157	V2BF2	99
P-2E-SKIT	169	SCVX12	69	T3F3	156	V2BF2-B	99
P-2H-SKIT	78	SHD2F1	43	T3F3-PV	157	V2BF2-B-E	106
P-2V-SKIT	110	SHD2F2	43	T3F3-SS	156	V2BF2-E	106
P-3E-SKIT	78	SHD2M1	43	T3F3-SS-PV	157	V2BF2-SS	99
P-3H-SKIT	78	SHD2M2	43	TD4.5DC-A	163	V2BF2-SS-E	106
P-3V-SKIT	110	SHD2S2	44	TD4DC-A	163	V2DC	108
P-4E-SKIT	169	SHD2S3	44	TD4F4-SS	163	V2DC-A	109
P-4EA-SKIT	171	SHD4F3	43	TD4PF4.5-SS	163	V2F1	99
P-4H-SKIT	78	SHD4M3	43	TR3BF3	113	V2F2	99
P-4V-SKIT	110	SHD4M4	43	TR3F3	113	V2F2-B	99

# Parte	# Página	# Parte	# Página	# Parte	# Página	# Parte	# Página
V2F2-B-E	106	V6BF6-SS-E	106	VEP4BF6	137	WS16BF16	149
V2F2-E	106	V6DC-A	109	VEP4DC-A	139	WS16BF16-SS	149
V2F2-SS	99	V6F6	99	VEP4F4	137	WS16DC-A	151
V2F2-SS-E	106	V6F6-B	99	VEP4F4-BOP	141	WS16F16	149
V2JM2	104	V6F6-B-E	106	VEP4F6	137	WS16F16-BOP	154
V2M1	103	V6F6-E	106	VEP4OF4	137	WS16F16-SS	149
V2M2	103	V6F6-SS	99	VEP4OF5	137	WS16F16-SS-BOP	154
V2M2-B	103	V6F6-SS-E	106	VEP4OF6	137	WS16FH16	150
V2M2-B-E	108	V6JM6	104	VEP6BF6	137	WS16FP16	150
V2M2-E	108	V6M6	103	VEP6DC-A	139	WS16OF16	149
V2M2-SS	103	V6M6-B	103	VEP6F6	137	WS6BF6	149
V2M2-SS-E	108	V6M6-B-E	108	VEP6F6-BOP	141	WS6BF6-SS	149
V2OF2	99	V6M6-E	108	VEP6FH6	138	WS6DC-A	151
V3-BRKIT	111	V6M6-SS	103	VEP6FP6	138	WS6F4	149
V3-RKIT	111	V6M6-SS-E	108	VEP6OF6	137	WS6F4-BOP	154
V3-SSRKIT	111	V6OF6	99	VEP8BF8	137	WS6F6	149
V3BF3	99	V8-BRKIT	111	VEP8DC-A	139	WS6F6-BOP	154
V3BF3-B	99	V8-RKIT	111	VEP8F8	137	WS6F6-SS	149
V3BF3-B-E	106	V8-SSRKIT	111	VEP8F8-BOP	141	WS6F6-SS-BOP	154
V3BF3-E	106	V8BF8	99	VEP8F8-SS	137	WS6FH6	150
V3BF3-SS	99	V8BF8-B	99	VEP8FH8	138	WS6FP6	150
V3BF3-SS-E	106	V8BF8-B-E	106	VEP8FP8	138	WS6OF6	149
V3DC-A	109	V8BF8-E	106	VEP8OF8	137	WS8BF8	149
V3F3	99	V8BF8-SS	99	W10-BMF	145	WS8BF8-SS	149
V3F3-B	99	V8BF8-SS-E	106	W10-RKIT-V2	146	WS8DC-A	151
V3F3-B-E	106	V8DC-A	109	W10BF10-B	145	WS8F8	149
V3F3-E	106	V8F8	99	W10DC	146	WS8F8-BOP	154
V3F3-SS	99	V8F8-B	99	W10F10-B	145	WS8F8-SS	149
V3F3-SS-E	106	V8F8-B-E	106	W12-BMF	145	WS8F8-SS-BOP	154
V3F4	99	V8F8-E	106	W12-RKIT-V2	146	WS8FH8	150
V3JM3	104	V8F8-SS	99	W12BF12-B	145	WS8FP8	150
V3M3	103	V8F8-SS-E	106	W12DC	146	WS8OF8	149
V3M3-B	103	V8JM8	104	W12F12-B	145		
V3M3-B-E	108	V8M8	103	W2DC	146		
V3M3-E	108	V8M8-B	103	W2F1-B	145		
V3M3-SS	103	V8M8-B-E	108	W3DC	146		
V3M3-SS-E	108	V8M8-E	108	W3F2-B	145		
V3OF3	99	V8M8-SS	103	W3F3-B	145		
V4-BRKIT	111	V8M8-SS-E	108	W6-BMF	145		
V4-RKIT	111	V8OF8	99	W6-RKIT-V2	146		
V4-SSRKIT	111	VEP10BF10	137	W6BF4-B	145		
V4BF4	99	VEP10DC-A	139	W6BF6-B	145		
V4BF4-B	99	VEP10F10	137	W6DC	146		
V4BF4-B-E	106	VEP10F10-BOP	141	W6F4-B	145		
V4BF4-E	106	VEP10FH10	138	W6F6-B	145		
V4BF4-SS	99	VEP10FP10	138	W8-BMF	145		
V4BF4-SS-E	106	VEP10OF10	137	W8-RKIT-V2	146		
V4DC-A	109	VEP12BF12	137	W8BF8-B	145		
V4F4	99	VEP12DC-A	139	W8DC	146		
V4F4-B	99	VEP12F12	137	W8F8	145		
V4F4-B-E	106	VEP12F12-BOP	141	W8F8-B	145		
V4F4-E	106	VEP12FH12	138	WS10BF10	149		
V4F4-SS	99	VEP12FP12	138	WS10BF10-SS	149		
V4F4-SS-E	106	VEP12OF12	137	WS10DC-A	151		
V4F6	99	VEP16BF16	137	WS10F10	149		
V4JM4	104	VEP16DC-A	139	WS10F10-BOP	154		
V4M4	103	VEP16F16	137	WS10F10-SS	149		
V4M4-B	103	VEP16OF16	137	WS10F10-SS-BOP	154		
V4M4-B-E	108	VEP2BF2	137	WS10FH10	150		
V4M4-E	108	VEP2DC-A	139	WS10FP10	150		
V4M4-SS	103	VEP2F2	137	WS10OF10	149		
V4M4-SS-E	108	VEP2OF3	137	WS12BF12	149		
V4OF4	99	VEP3BF3	137	WS12BF12-SS	149		
V6-BRKIT	111	VEP3BF4	137	WS12DC-A	151		
V6-RKIT	111	VEP3DC-A	139	WS12F12	149		
V6-SSRKIT	111	VEP3F3	137	WS12F12-BOP	154		
V6BF6	99	VEP3F3-BOP	141	WS12F12-SS	149		
V6BF6-B	99	VEP3F4	137	WS12F12-SS-BOP	154		
V6BF6-B-E	106	VEP3F4-BOP	141	WS12FH12	150		
V6BF6-E	106	VEP3OF4	137	WS12FP12	150		
V6BF6-SS	99	VEP4BF4	137	WS12OF12	149		

Glosario

Presión Absoluta: La suma de la presión del manómetro y la presión atmosférica.

Desconexión Accidental: La desconexión de un acople durante la operación debido a un fallo del mecanismo de acoplamiento (desconexión inintencionada)

Acumulador: Un contenedor donde se almacena el fluido bajo presión para un suministro de reserva de fluido.

Aereación: Aire en un fluido.

Inclusión de aire: El aire forzado dentro del sistema durante la conexión de un cople rápido.

Presión atmosférica: Presión que emite la atmósfera en cualquier lugar. La presión al nivel del mar es aproximadamente 14.7 PSI.

Contrapresión: Se refiere a la presión que existe en el lado de descarga de un sistema.

Bar: Unidad estándar internacional de presión igual a 100,000 Pascals, aproximadamente 1.5 PSI.

Blind-Mate: Cuando un acople puede ser conectado sin intervención humana o visibilidad.

Break-Away: Desconexión automática de un acople cuando una fuerza axial de separación se aplica.

Efecto Brinell: Abolladuras en los hombros del cople macho hechas por balines en el acople hembra. Esta terminología se deriva de una prueba para evaluar la dureza de los metales. El metalurgista sueco Johan August Brinell (1849-1925), desarrolló una prueba para medir la dureza relativa de los metales y aleaciones, forzando una bola de acero de 10mm con una carga de 3,000 kg por 30 segundos. Después de completarse la prueba, la superficie del área afectada se media.

Presión de Reventón: La presión en la cual un dispositivo pierde su capacidad de retener la presión.

Endurecimiento de Caja: Endurecimiento de la superficie completa de un acero bajo en carbón a una densidad específica.

Cavitación: Una condición gaseosa que se encuentra dentro de un flujo líquido y que ocurre donde la presión se reduce a la presión del vapor.

Presión de Carga: La presión en la que se abastece el fluido dentro del sistema hidráulico (arriba de la presión atmosférica).

Válvula Check: Una válvula que permite que el flujo de un medio en una sola dirección.

Flujo Frío: Deformación continua bajo carga.

Connect Under Pressure: La habilidad de conectar un acople con presión interna aplicada en ambos lados del ensamble.

Contaminación: Cualquier material foráneo que entra en un medio y que puede afectar su desempeño dentro de un sistema.

Acople, Mitad Hembra: cople, socket, receptor

Acople, Mitad Macho: niple, adaptador

Acople de Desconexión Rápida: Un componente que puede unirse y separarse rápidamente sin la necesidad de herramientas o dispositivos especiales.

Presión Diferencial: (DP) La diferencia de presión entre dos puntos de un sistema o un componente, también conocido como Delta-P o caída de presión.

Desconexión Seca: Un acople que permite una conexión y desconexión sin derrames o inclusión de aire (cara plana, libre-de-fugas)

Manga de Doble Acción: Permite las acciones push-to-connect y pull-to-connect cuando la mitad hembra se monta sobre la manga.

Tapa: Protector de un niple contra polvo o suciedad

Tapón: Protector de un cople contra polvo o suciedad

Presión Dinámica: Presión que una vez liberada permite ser inmediatamente reabastecida.

Glosario

Check de flujo: Ocurre cuando una válvula cierra durante condiciones de flujo, como cuando se baja rápidamente una herramienta.

Posición Flush 'al ras' (válvula): Una válvula libre de fugas que permite una conexión y desconexión sin derrames o inclusión de aire.

Force to Connect o 'Fuerza para Conectar': Fuerza axial o giratoria requerida para completar la conexión.

Force to Disconnect o 'Fuerza para Desconectar': Lo contrario a lo anterior.

GPM: Acrónimo de Galones por Minuto, una medida de flujo.

Fuga: El medio que sin intención se libera de un acople debido a una falla en el componente o debilidad de retención.

LPM: Acrónimo de Litros por Minuto, una medida de flujo.

Endurecimiento por Inducción: El endurecimiento de una área con medio o alto contenido de carbón.

Presión de Operación: La presión a la que el sistema opera.

Pico de Presión: Presión máxima momentánea que se encuentra durante la operación de un componente.

Tapa de presión: Una tapa que incorpora un sello capaz de soportar los valores de presión en el acople macho.

Prueba de impulso de presión: Proceso de sumisión de un componente a una presión específica en un rango específico de incrementos y decrecimientos en un límite de tiempo y ciclo.

Presión de prueba: La presión no-destructiva de una prueba en exceso, generalmente 1.5 veces la presión estándar de operación.

PSI: Acrónimo de 'Pounds per Square Pulg' o Libras por pulgada cubica, una medida de presión.

Push to Connect o 'Empuja para Conectar': Un mecanismo de cierre que permite la conexión con una sola mano empujando el niple dentro del cople. (Manga automática, collar automático, conexión automática).

Rotación: El acto de girar el cople y niple en direcciones opuestas de manera continua en 360°.

Manga Acción Sencilla: Hacer conexión requiere tirar manualmente la manga de la hembra, insertando la punta macho (manga semi-automática, manga manual)

Manga de Seguridad: Un dispositivo que brinda un seguro adicional y que se activa antes de que la manga de seguridad sea retraída (pin-lock, manga de seguridad).

Derrames: Fluido liberado del sistema debido a una desconexión de un cople rápido. Este fluido está atrapado entre el sello y la válvula del sello en las mitades del acople.

Presión estática: La presión que una vez liberada y no se puede re-abastecer inmediatamente.

Flujo de Sobretensión: Un rápido incremento de flujo.

Giratorio: El acto de girar el acople y el niple en direcciones opuestas a un grado menor a 360°.

Construcción Térmica: La presión causada por la expansión del producto debido al calor de una fuente externa como luz del sol (expansión térmica).

Presión Atrapada: Fluido presurizado atrapado dentro de una válvula cerrada.

Turbulencia: Es la condición donde el producto no se mueve suavemente hacia la dirección del flujo. El flujo turbulento es causa de cambios abruptos en dirección, cambios en secciones transversales o por alta velocidad. El resultado es incremento de fricción que genera el calor, decrecimiento de presión operativa y pérdida de poder.

Twist Lock: Una acción giratoria que libera el seguro de las mitades del acople.

Vacío: Aire, gas o productos completa o parcialmente exhaustos para crear presión negativa. Teóricamente, un vacío perfecto debe ser medido con 20 pulgadas de mercurio, pero eso es casi imposible. El vacío perfecto es 29.7 pulgadas de mercurio.

F - 4 - H - F - 4 - B - E - LS - 7

Tamaño

1	1/8"
1.25	4mm
1.5	3/16"
1.88	6mm
2	1/4"
2.5	5/16"
2.83	9mm
3	3/8"
4	1/2"
5	5/8"
6	3/4"
8	1"
10	1-1/4"
12	1-1/2"
16	2"
20	2-1/2"
24	3"

Extremo

1	1/8"
1.25	4mm
1.5	3/16"
1.88	6mm
2	1/4"
2.5	5/16"
2.83	9mm
3	3/8"
4	1/2"
5	5/8"
6	3/4"
8	1"
10	1-1/4"
12	1-1/2"
16	2"
20	2-1/2"
24	3"

Materiales

S	Al 303
SS	A.I. 316
A	aluminio
B	latón

Material estándar acero.
No es necesario designar para configuraciones estándar..

Opciones de Válvula

SSV	Válvula Al 316
SV	Válvula Al 303
BTV	Válvula Latón
BV	Válvula latón
E	Sin válvula
HV	Trabajo Pesado
PV	Válvula Poppet
RV	Válvula Prong
TV	Válvula Tubo
V	Con Válvula
VA	Actuador de Válvula

Sellos

H	Aflas™
C	Repuestos Celazole
CZ	Chemrez
P	EPDM
PS	EPDM (Vapor)
D	FDA FKM
F	FKM
FS	Fluoro Silicón
JF	Combustible
Hidrocarbano Nitrilo	
K4	Kalrez® 4079
K6	Kalrez® 6375
K7	Kalrez® 7075
M	Military low temp nitrilo
E	Neoprene
M1	Nitrilo (FDA)
T	PTFE
TS	PTFE / Silicón
S	Silicón
U	Uretano

Sello estándar de Nitrilo.
No es necesario designar para configuraciones estándar.

Serie

T	10K Roscable
AG	Intercambio Agrícola Hidráulico
M	Intercambio ARO 210/310
J	Intercambio Automotriz
N	Intercambio Bowes
A	Compacto
CJ	Intercambio Europeo Alto Flujo
CVV	Screw Together Europeo
ST	Cara Plana Trabajo Pesado
WS	Wingstyle Trabajo Pesado
WS-BOP	Wingstyle Trabajo Pesado Preventor de Reventón
TD	Coples Alta Presión
DF	Intercambio Industrial Neumático
HTZ	Cople ISO16028 Conecta-presión
HTE	Niple ISO16028 Conecta-bajo-presión
HT	Intercambio ISO16028 Cara Plana
K	Intercambio ISO-A Móvil
H	Intercambio Industrial ISO-B
HS	Intercambio ISO-B Vapor
NK	Intercambio Industrial Japones
L	Intercambio Lincoln Vástago Largo
V	MIL-C-51234
CM	Intercambio Molde Enfriador
SHD	Intercambio Rectus 17/Schrader
BR	Intercambio Rectus 21
SCV	Válvula de Seguridad Check
E	Intercambio Paso Libre Lavado a Presión
EA	Intercambio Paso Libre Chorro de Agua
TR	Intercambio TEMA Europeo
P	Intercambio Thor
U	Coples Combo Neumáticos Universales
VEP-BOP	Intercambio Preventor de Reventón
VEP	Intercambio Hidráulico VEP
W	Intercambio Wingstyle

End Connection

4B	45° Barba Push-loc
4S	45° Barba para Manguera
9B	90° Barba Push-loc
9S	90° Barba para Manguera
RB	Pasamuros ORFS
FH	Código 62 Brida
FP	Código 62 Brida
CS	Collar Barba para Manguera
JF	Hembra 37° JIC
BF	Hembra BSPP
FM	Hembra metrica
PF	Hembra Roscas MP
F	Hembra NPT(F)
OF	Hembra ORB
S	Barba para Manguera
JM	Macho 37° JIC
GM	Macho BSPP
BM	Macho BSPT
JB	Macho pasamuros 37° JIC
MM	Macho Metrico
M	Macho NPT(F)
OM	Macho ORB
RM	Macho ORFS
MBM	Pasamuros Métrico
B	Barba Push-loc
P	Conexión de tubo

Opciones de Manga

HNS	Al 303 manga tuerca
XLS	Al 303 manga seguridad
XS	Al 303 manga
YLS	Al 316 manga seguridad
YS	Al 316 manga
PB	Lazo bola automático
PL	Lazo pin automático
BFS	Manga Latón Bridado
BLS	Manga seguridad Latón
BS	Manga Latón
FLS	Manga de Seguridad Bridada
FNS	Bridado nylon sleeve
FS	Bridado sleeve
HN	Manga Tuerca Hex
LS	Manga de Seguridad
NLS	Sin Manga de Seguridad
FSB	Silicón para Freidora
ZFS	Manga Acero Bridada
ZLS	Manga Seguridad Bridada
ZS	Manga de Acero
TP	Preventor de enredo

Otras Opciones

4	Platinado Óxido Negro
7	Niquel Brillante
11	Cromo sobre Niquel
8	Niquelado sin electricidad
HL	Hexagono extendido
BMF	Bracket para Brida
L##	Medida
C1	Limpiado con Oxygen
9	Cobertura PTFE
10	Niquelado estándar
WF	Superficies para llave

Para Designar Coples
La designación numérica del tamaño precede la designación alfa. Ejemplo: 2HF2 (Cople 1/4" ISO-B)

Para Designar Niples
La designación alfa precede la designación numerica del tamaño. Ejemplo: H2F2 (Niple 1/4" ISO-B)

Aflas™ es una marca de Asahi Glass Limited
Kalrez® es una marca de Dupont Polymers, Inc.
Teflon® es una marca de The Chemours Company FC, LLC
Viton® es una marca de The Chemours Company FC, LLC

! Muchas variaciones de numeros de parte están contenidas dentro de esta guía, puede ordenarlas utilizando el formato mostrado arriba. Algunas variaciones pueden requerir cantidades mínimas para ordenar, mayor tiempo de entrega y ajustes de precio basados en la construcción. Por favor contacte su representante de ventas Dixon para cualquier detalle que envuelva tu configuración de acople.

Garantía Limitada

DIXVA, S. de R.L. de C.V. subsidiaria de DIXON VALVE AND COUPLING COMPANY (aquí llamada "Dixon") garantiza que los productos descritos en este catálogo y manufacturados por Dixon están libres de defectos de material y de mano de obra bajo uso y servicio normales por un periodo de un año a partir de la fecha de envío por Dixon. Su única obligación bajo esta garantía limitada, a su opción, a reparar o a reemplazar, como a continuación se estipula, cualquier producto que se encuentre defectuoso a satisfacción de Dixon después de ser examinado por Dixon, considerando que dicho producto debe ser devuelto para inspección a Dixon dentro de los (3) meses siguientes al descubrimiento del defecto. La reparación o reposición de productos defectuosos se hará sin cargo por partes o mano de obra. Esta garantía no aplica a: a) partes o productos no manufacturados por Dixon, la garantía de dichos artículos está limitada a la garantía actual ofrecida a Dixon por su proveedor; b) cualquier producto alterado o reparado que haya sido sujeto a abuso, negligencia, accidente o mala aplicación; c) cualquier producto alterado o reparado por otros distintos a Dixon; d) a servicios normales de mantenimiento y el reemplazo de artículos de servicio (tales como arandelas, empaques y lubricantes) hecho en conexión con dichos servicios. Hasta donde lo permita la ley, esta garantía limitada se extiende solo al comprador directo y cualquier otra persona que demuestre ser usuario o consumidor de los productos y que se lastimado en su persona por cualquier incumplimiento de esta garantía. Ninguna acción podrá ser formulada en contra de Dixon por un supuesto incumplimiento de garantía a menos que dicha acción sea instituida dentro del periodo de garantía del producto. Esta garantía limitada se interpretará y se aplicará en toda medida permitida por la ley.

A parte de la obligación de Dixon aquí expuesta, Dixon desconoce toda garantía, expresa o implícita, incluyendo pero no limitada a cualquier garantía implícita de comerciabilidad o conveniencia para un propósito particular, y cualquier otra obligación o responsabilidad. Lo precedente constituye la única obligación de Dixon con relación a daños, ya sean directos, incidentales o por consecuencia, que resulten del uso o desempeño del producto.

Algunos productos y medidas pueden ser descontinuadas cuando el inventario sea agotado, o pueden requerir de una cantidad mínima para ordenar.

Responsabilidad Limitada

Este catálogo se ofrece como un producto más, no está destinado para utilizarse como manual técnico. La información de este catálogo está sujeta a cambios sin previo aviso. Todos los usuarios y distribuidores de productos vendidos mediante este catálogo deben contactar a Dixon para aclarar cualquier duda sobre el producto, uso, compatibilidad, procedimientos y tiempo de vida. Nuestro equipo de ingeniería y pruebas está siempre disponible para asesorar a distribuidores y usuarios.



Seguridad



Nuestro catálogo cuenta con avisos de seguridad que le recuerdan al usuario su deber de revisar cuidadosamente la compatibilidad del producto con el medio que fluye, las aplicaciones y el medio ambiente en el que será utilizado.

NOTA: Debido a los riesgos a la salud asociados con el contenido de plomo y otros contaminantes en los sistemas de agua potable. A menos que se especifique lo contrario, Dixon no recomienda el uso de sus productos para sistemas de agua potable y no deben utilizarse donde el agua para consumo esté en contacto con las superficies de los adaptadores.

Advertencia: Los productos Dixon pueden contener químicos identificados por el estado de California como causantes de cáncer, defectos de nacimiento, o problemas de reproducción.



Marcas Registradas

Delrin® y Zytel® con marcas de E.I. duPont Nemours and Company.

Kalrez® es una marca registrada de DuPont Dow Elastomers.

Todas las marcas que aparecen ilustradas en la lista de precios Dixon son propiedad de sus respectivos dueños.

Copyright

Copyright © 2020 por Dixon Valve and Coupling, LLC

Todos los derechos reservados. Este libro es un material protegido. El uso, reproducción o copia de este por alguien más que Dixon está estrictamente prohibido sin el consentimiento por escrito.

NOTA: Se ha puesto mucho cuidado preparando este catálogo. Dixon Valve & Coupling Company, LLC se reserva el derecho de hacer correcciones.

