

Índice

NÚMERO DE SERIE	PÁGINA
CONEXIONES PARA MANGUERA ESTÁNDAR	
102	Tubería Macho..... 2
102-SS	Tubería Macho Inoxidable 2
102-BSPT	Macho BSPT..... 2
103	Tubería Macho Giratorio 3
104	Tubería Hembra..... 3
104-SS	Tubería Hembra Inoxidable 3
105	Tubería Hembra Giratoria 4
124	Hembra Giratoria-Asiento de Bola 4
126	Hembra Giratoria-Asiento de Empaque..... 4
129	Codo 90°, Tubería Macho..... 5
129-SS	Codo 90°, Tubería Macho-Acero Inoxidable..... 5
134	Codo 90°, Tubería Hembra..... 5
139	Codo 45°, Tubería Macho..... 6
142	Macho 45° SAE 6
143	Hembra Giratoria 45° SAE/37° JIC Asiento de Ángulo Dual 6
144	Hembra Giratoria 45° SAE 7
145	Hembra Giratoria 37° JIC 7
177	Codo 90° de unión 7
177-SS	Codo 90° de unión en acero inoxidable..... 8
178	Unión para Manguera 8
178-SS	Unión para Manguera-Acero Inoxidable 8
179	Tee Unión..... 9
179-SS	Tee Unión-Acero Inoxidable..... 9

CONECTORES PARA SOLDAR	
152	Rosca Mano Derecha (Línea de Oxígeno)..... 10
154	Rosca Mano Izquierda (Línea de Acetileno)..... 10
156	Adaptador-Rosca Mano Derecha x Rosca NPTF 11
158	Adaptador-Rosca Mano Izquierda x Rosca NPTF 11

FÉRULAS DE LATÓN Y PRENSA	
200	Férulas de Latón..... 12
200-FC	Prensa para Férulas 12

CONEXIONES REUTILIZABLES	
180	Férula..... 14
180-SS	Férula-Acero Inoxidable..... 14
182	Vástago Macho..... 14
182-SS	Vástago Macho-Acero Inoxidable..... 14
183	Set Reutilizable-Férula y Vástago Macho..... 15
183-SS	Set Reutilizable- Acero Inoxidable 15
184	Vástago Hembra Giratorio 16
185	Set Reutilizable-Férula y Vástago Hembra..... 16
186	Unión de Vástago Reutilizable..... 17
187	Unión de Manguera (Férulas y Unión)..... 17

NÚMERO DE SERIE	PÁGINA
CONEXIONES PARA ABRAZADERA	
268B	Tubería Macho..... 17

CONEXIONES PARA MANGUERA LOK-ON (Estilo Push-on)	
270-AT	Herramienta de Ensamble 18
271	Tubería Macho Giratorio 18
272	Tubería Macho..... 19
272W	Tapa Lok-on Amarilla 19
272-SS	Tubería Macho-Acero Inoxidable..... 19
273	Codo 90°, Tubería Macho..... 20
274	Tubería Hembra..... 20
572	Macho GHT 21
574	Hembra GHT 21
575	Set para Manguera de Jardín 21
278	Hembra Giratoria-Asiento de Bola 22
280	Hembra Giratoria-Asiento de Empaque..... 22
282	Macho 45° SAE 22
284	Hembra Giratoria 45° SAE 23
286	Macho 37° JIC 23
287	Hembra Giratoria 45° SAE/37° JIC Asiento de Ángulo Dual 23
287-SS	Hembra Giratoria 45° SAE/37° JIC Asiento de Ángulo dual-Acero Inoxidable..... 23
288	Hembra Giratoria 37° JIC 24
288-SS	Hembra Giratoria 37° JIC-Acero Inoxidable 24
289	Hembra Giratoria Codo 90° 24
290	Macho Giratorio SAE Biselado Invertido 24
292	Hembra SAE Biselado Invertido 25
294	Vástago de Tubo Rígido 25
294-SS	Vástago de Tubo Rígido - Acero Inoxidable 25
296	Unión de Manguera 25
296-SS	Unión de Manguera-Acero Inoxidable 25

CONEXIONES PARA TUBERÍA DE LATÓN	
163	Niple de Cabeza Hexagonal 26
165	Niple Corto..... 26
166	Niple Largo 26-27
169	Codos 90° Macho 27
172	Unión Macho-NPSM x NPTF..... 27
174	Adaptador Macho NPSM x Hembra NPTF 27
176	Unión Macho-NPSM 28
207-BH	Acople Pasamuros..... 28
211	Niple de cabeza Cuadrada - Plomo bajo 28
213	Tapa para tubería..... 29
219	Niple Hexagonal - Plomo bajo 29
228	Cruceta Hembra 29
302	Codo 90° Hembra 30
304	Codo 90° 30
306	Codo 45° 30
322	Tee Hembra 31
324	Tee de Ramificación Macho..... 31
326	Tee 31
370	Niple Hexagonal Macho..... 32
371	Acople Hexagonal Hembra..... 32
373	Bushing Reductor 32
375	Adaptador-Hembra x Macho..... 33
377	Acople Reductor-Hembra Doble..... 33
379	Niple Hexagonal Reductor Macho 33

ÍNDICE

NÚMERO DE SERIE	PÁGINA
CONEXIONES PARA MANGUERA DE JARDÍN	
500	Accesorios para Manguera de Jardín..... 34
501	Hembra GHT x Macho NPTF, no-giratoria..... 35
501-SS	Hembra GHT x Macho NPTF, no-giratoria Acero Inoxidable..... 35
502	Hembra GHT x Macho NPTF, giratoria..... 35
502-SS	Hembra GHT x Macho NPTF, giratoria Acero Inoxidable..... 35
503	Hembra GHT x Macho NPTF, no-giratoria..... 35
503-SS	Hembra GHT x Macho NPTF, no-giratoria Acero Inoxidable..... 35
504	Hembra GHT x Macho NPTF, giratoria..... 35
504-SS	Hembra GHT x Macho NPTF, giratoria Acero Inoxidable..... 35
506	Hembra GHT x Hembra GHT, giratoria..... 36
507	Macho GHT x Hembra NPTF 36
507-SS	Macho GHT x Hembra NPTF - Acero Inox 36
508	Macho GHT x Macho NPTF 36
508-SS	Macho GHT x Macho NPTF - Acero Inoxidable..... 36
509	Macho GHT x Macho GHT 36
509-SS	Macho GHT x Macho GHT - Acero Inoxidable..... 36
513	Tapón para Manguera..... 37
514	Macho GHT x Macho NPTF x Hembra NPTF 37
514-SS	Macho GHT x Macho NPTF x Hembra NPTF - Acero Inoxidable..... 37
578	Unión GHT..... 37
585	Vástago Corto Macho..... 37
586	Vástago Corto Hembra Giratoria, Tuerca Red 38
587	Vástago Corto (hembra y macho giratorio), Tuerca Redonda. 38
588	Vástago Corto Hembra Giratoria, Tuerca hex. 38
589	Vástago Corto (hembra y macho giratorio), Tuerca hex..... 38
590	Macho GHT 39
590-SS	Macho GHT - Acero Inoxidable..... 39
591	Hembra GHT Giratoria..... 39
591-SS	Hembra GHT - Acero Inoxidable..... 39
592	Set de Manguera de Jardín (hembra y macho giratorio)..... 39
592-SS	Set de Manguera de Jardín (hembra y macho giratorio) Acero Inoxidable. 39
593	Macho Vástago Largo..... 40
594	Vástago Largo Hembra Giratoria..... 40
595	Set de Vástago Largo (hembra y macho giratoria)..... 40
833	Válvula de Rocío..... 41
832	Válvula de Rocío..... 41

GWH	Ensamblados, Acoples y Conexiones de Manguera Engrasadora..... 42
GWHZ	Conexiones Zerk..... 42

Debido a los peligros asociados con la contaminación y contenido de plomo en sistemas de agua potable, los acoples Dixon, a menos que indique lo contrario, no son recomendados para servicios de agua potable y no deben ser usados en aplicaciones donde el agua para tomar esté en contacto con superficies de los acoples.

NÚMERO DE SERIE	PÁGINA
CONEXIONES DE COMPRESIÓN	
60C	Manga..... 43
60PT	Manga de Acetal..... 43
61C	Tuerca..... 43
61CL	Tuerca Larga 43
62C	Unión 44
62CBH	Unión Pasamuros 44
63PT	Inserto de Latón..... 44
66C	Conector Hembra 45
68C	Conector Macho 45
164C/	
264C	Te Unión..... 46
165C	Codo Unión..... 46
169C/	
269C	Codo Macho 47
170C	Codo Hembra 47
171C	Te de Flujo Macho 47
172C	Te de Ramificación Macho..... 48
176C	Te Adaptador..... 48
177C	Te de Ramificación Hembra..... 48
179C	Codo 45° 48
639C	Tapón Sellador..... 49
682C	Acople para Tanque de Paso Directo 49

CONEXIONES PARA FRENOS DE AIRE D.O.T.

60NAB	Barril 50
61NAB	Tuerca..... 51
62NAB	Unión 51
62NABH	Unión Pasamuros 51
62NBH	Unión Pasamuros 51
62NFBH	Unión Pasamuros 52
63NAB	Inserto Inoxidable 52
64NAB	Te Unión..... 52
65NAB	Codo Unión..... 53
66NBH	Unión Pasamuros 53
66NAB	Conector Hembra 53
68NAB	Conector Macho 54
69NAB	Codo Macho 54
70NAB	Codo Hembra 55
71NAB	Te de Flujo Macho 55
72NAB	Te de Ramificación Macho..... 56
79NAB	Codo 45° 56
NAB	Tubing Nailon..... 50
TC97	Cortadora de Tubing 50

CONEXIONES PARA FRENOS DE AIRE D.O.T. - MANGUERA DE HULE

56RBSG	Resorte 57
60RB	Manga..... 57
61RB	Tuerca..... 57
61RBSG	Tuerca con Guarda de Resorte 57
67RBSG	Tuerca Macho con Resorte Protector..... 57
68RB	Conector Macho (Cuerpo) 58
68RBSG	Conector Macho con Resorte Protector 58

CONEXIONES LIBRES DE PLOMO

LIBRE DE PLOMO 59-63
-----------------------	-------------

En orden de servirte mejor, Dixon Brass continua produciendo medidas fuera del catálogo y productos bajo pedido y entrega especiales. Por favor contacte a Dixon para más detalles.

Conexiones de Latón

Como usar los números de parte de las conexiones de latón

1020406C

IDENTIFICACIÓN DE LA SERIE

1020406C

D.I. MANGUERA (Medido en deciseisavos)

1020406C

MEDIDA DE ROSCA (Medido en deciseisavos)

1020406C

MATERIAL/TIPO DE ROSCA

Todas las conexiones son maquinadas de aleaciones de latón CDA, 360 y 377, y aleaciones de acero inoxidable 316, 303 ó 304.

Serie 102

Latón 360 CDA

Serie 102-SS

Tipo 316 inoxidable



Serie 102-BSPT

British Standard Pipe Thread
Latón 360 CDA

Para Al contacte a Dixon para precio y disponibilidad

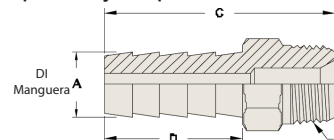

MACHO ROSCA NPTF

National Pipe Tapered - Dryseal

Latón Número de Parte	SS	BSPT	DI manguera A	Rosca NPTF ** B	Longitud C	Hex	Barbas	Longitud de barba D	Cant. por Caja	Lbs. por 100 pzs.
1020202C	SS		1/8	1/8-27	1.06	7/16	3	.46	100 *	1.8
1020204C				1/4-18	1.16	9/16	3	.46	100	3.1
1020302C	SS		3/16	1/8-27	1.35	7/16	3	.75	100 *	2.2
1020304C	SS			1/4-18	1.54	9/16	3	.75	100 *	4.0
1020402C	SS	BSPT		1/8-27	1.57	1/2	4	.97	100 *	2.9
1020404C	SS	BSPT	1/4	1/4-18	1.76	9/16	4	.97	100 *	4.3
1020406C	SS			3/8-18	1.76	11/16	4	.97	100 *	5.4
1020408C				1/2-14	1.97	7/8	4	.97	50	13.8
1020502C	SS		5/16	1/8-27	1.57	1/2	4	.97	100 *	2.9
1020504C	SS			1/4-18	1.76	9/16	4	.97	50 *	4.3
1020506C	SS			3/8-18	1.76	11/16	4	.97	50 *	5.6
1020602C	SS			1/8-27	1.57	1/2	4	.97	100 *	3.8
1020604C	SS	BSPT		1/4-18	1.76	9/16	4	.97	100 *	4.8
1020606C	SS	BSPT	3/8	3/8-18	1.76	11/16	4	.97	50 *	6.1
1020608C	SS	BSPT		1/2-14	1.97	7/8	4	.97	25 *	10.8
1020612C				3/4-14	1.97	1-1/16	4	.97	25	14.9
1020804C	SS		1/2	1/4-18	1.76	5/8	4	.97	50 *	6.7
1020806C	SS	BSPT		3/8-18	1.76	11/16	4	.97	50 *	6.9
1020808C	SS	BSPT		1/2-14	1.97	7/8	4	.97	25 *	12.0
1020812C	SS			3/4-14	1.97	1-1/16	4	.97	25 *	15.7
1021006C	SS		5/8	3/8-18	1.76	11/16	4	.97	50 *	7.8
1021008C	SS			1/2-14	1.97	7/8	4	.97	25 *	11.6
1021012C	SS			3/4-14	1.97	1-1/16	4	.97	25 *	15.7
1021208C	SS		3/4	1/2-14	2.19	7/8	4	1.19	25 *	16.4
1021212C	SS	BSPT		3/4-14	2.19	1-1/16	4	1.19	20 *	18.0
1021612C	SS		1	3/4-14	2.19	1-1/16	5	1.19	20 *	25.0
1021616C		BSPT		1-11-1/2++	2.54	1-3/8	5	1.19	10	37.1
1022012C			1-1/4	3/4-14	2.37	1-3/8	5	1.19	10	38.7
1022016C				1-11-1/2++	2.54	1-3/8	5	1.19	5	46.9

* Para Acero Inoxidable, quitar la terminación 'C' y añadir 'SS'

** Rosca NPT en 102-SS

++ roscas disminuidas

Serie 103

NPTF- MACHO GIRATORIO BARBA PARA MANGUERA *National Pipe Tapered - Dryseal*

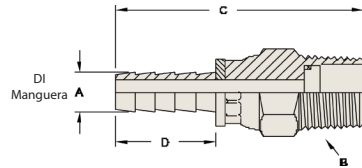

Latón Número de Parte	DI manguera A	Rosca NPTF B	Longitud C	Hex	Barbas	Longitud de barba D	Cant. por Caja	Lbs. por 100 pzs.
1030402C	1/4	1/8-27	2.19	9/16	4	.97	100	3.5
1030404C		1/4-18	2.12	9/16	4	.97	100	6.0
1030604C	3/8	1/4-18	2.12	9/16	4	.97	100	6.6
1030606C		3/8-18	2.12	11/16	4	.97	50	8.4
1030806C	1/2	3/8-18	2.12	11/16	4	.97	50	9.7
1030808C		1/2-14	2.33	7/8	4	.97	25	14.1
1031212C	3/4	3/4-14	2.33	1-1/16	4	.97	20	20.7
1031616C	1	1-11-1/2 +	3.43	1-3/8	5	1.19	10	40.0

Nota: La giratoria es únicamente para comodidad en el montaje. Máximo 120 PSI
+ roscas disminuidas

Serie 104

Latón 360 CDA

NPTF- HEMBRA BARBA PARA MANGUERA - RÍGIDA *National Pipe Tapered - Dryseal*

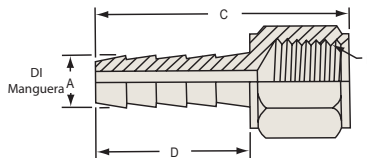

Número de Parte	SS 303	DI manguera A	Rosca NPTF ** B	Longitud C	Hex	Barbas	Longitud de barba D	Cant. por Caja	Lbs. por 100 pzs.
1040202C		1/8	1/8-27	.96	1/2	3	.46	100	2.1
1040204C			1/4-18	1.15	5/8	3	.46	100	4.0
1040302C		3/16	1/8-27	1.25	1/2	3	.75	100	2.4
1040304C			1/4-18	1.44	5/8	3	.75	100	4.3
1040402C	SS	1/4	1/8-27	1.47	1/2	4	.97	100	2.8
1040404C			1/4-18	1.66	5/8	4	.97	100 *	4.6
1040406C			3/8-18	1.66	3/4	4	.97	50	5.6
1040408C			1/2-14	1.66	15/16	4	.97	50	8.1
1040502C		5/16	1/8-27	1.47	9/16	4	.97	100	3.6
1040504C			1/4-18	1.66	5/8	4	.97	100	4.7
1040506C			3/8-18	1.66	3/4	4	.97	50	5.7
1040602C	SS	3/8	1/8-27	1.47	9/16	4	.97	100	4.2
1040604C			1/4-18	1.66	5/8	4	.97	50 *	5.4
1040606C	SS	3/8	3/8-18	1.66	3/4	4	.97	50 *	6.3
1040608C	1/2-14		1.66	15/16	4	.97	50	8.8	
1040612C	SS	1/2	3/4-14	1.97	1-3/16	4	.97	25	20.6
1040804C			1/4-18	1.66	5/8	4	.97	50	6.2
1040806C			3/8-18	1.66	3/4	4	.97	50	7.3
1040808C			1/2-14	1.66	15/16	4	.97	50 *	9.3
1040812C		3/4	3/4-14	1.97	1-3/16	4	.97	25	25.8
1041006C			3/8-18	1.66	3/4	4	.97	50	7.5
1041008C		5/8	1/2-14	1.66	3/4	4	.97	25	10.0
1041012C			3/4-14	1.97	1-3/16	4	.97	25	20.6
1041208C		3/4	1/2-14	1.88	15/16	4	1.19	25	12.5
1041212C			3/4-14	2.19	1-3/16	4	1.19	20	22.6
1041612C		1	3/4-14	2.19	1-3/16	5	1.19	20	26.1
1041616C			1-11-1/2	2.32	1-3/16	5	1.19	10	34.7
1042016C		1-1/4	1-11-1/2	2.32	1-7/16	5	1.19	10	43.7

* Para Acero Inoxidable, quitar la terminación 'C' y añadir 'SS'

**Rosca NPT en 104-SS

Serie 105

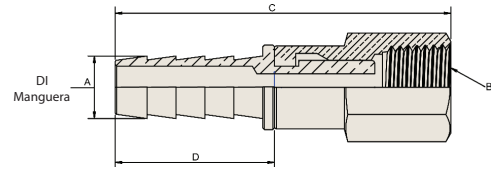

HEMBRA NPTF GIRATORIA X BARBAS PARA MANGUERA *Tubería Corta Cónica - Dryseal*

Número de Parte	DI manguera A	Rosca PTF-SAE B	Longitud C	Hex	Barbas	Longitud de Barba D	Cant. por Caja	Lbs. por 100 pzs.
1050404C	1/4	1/4-18	2.20	5/8	4	.97	50	5.6
1050604C	3/8	1/4-18	2.20	5/8	4	.97	50	6.2
1050606C		3/8-18	2.20	3/4	4	.97	50	8.7
1050806C	1/2	3/8-18	2.20	3/4	4	.97	50	8.7
1050808C		1/2-14	2.40	15/16	4	.97	25	14.3

Nota: La giratoria es únicamente para comodidad en el montaje.

Serie 124

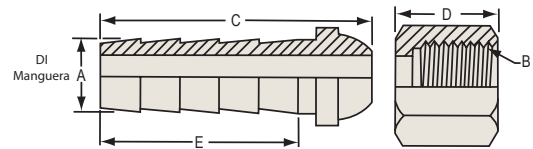

HEMBRA NPSM GIRATORIA X BARBAS PARA MANGUERA *National Pipe Straight - Tipo Ball Seat*

Número de Parte	DI manguera A	Rosca NPSM B	Longitud de Vástago C	Longitud de Rosca D	Hex	Barbas	Longitud de Barba E	Cant. por Caja	Lbs. por 100 pzs.
1240202K	1/8	1/8-27	.79	.44	1/2	3	.46	100	2.3
1240302K	3/16	1/8-27	1.08	.44	1/2	3	.75	100	2.6
1240304K		1/4-18	1.17	.53	5/8	3	.75	100	4.5
1240402K	1/4	1/8-27	1.30	.44	1/2	4	.97	100	3.0
1240404K		1/4-18	1.39	.53	5/8	4	.97	100	4.8
1240406K	5/16	3/8-18	1.41	.63	3/4	4	.97	100	6.7
1240504K		1/4-18	1.39	.53	5/8	4	.97	100	5.0
1240506K	3/8	3/8-18	1.41	.63	3/4	4	.97	50	6.6
1240604K		1/4-18	1.37	.53	5/8	4	.97	100	4.9
1240606K	1/2	3/8-18	1.45	.63	3/4	4	.97	100	7.1
1240608K		1/2-14	1.54	.69	15/16	4	.97	100	12.4
1240806K	3/4	3/8-18	1.42	.63	3/4	4	.97	50	7.5
1240808K		1/2-14	1.54	.69	15/16	4	.97	100	12.7
1241212K	1	3/4-14	1.69	.75	1-1/8	4	1.19	50	17.4

Serie 126

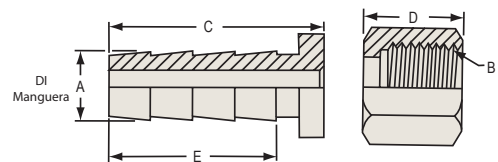

HEMBRA NPSM GIRATORIA X BARBAS PARA MANGUERA *National Pipe Straight - Asiento de Empaque*

Número de Parte	DI manguera A	Rosca NPSM B	Longitud de Vástago C	Longitud de Rosca D	Hex	Barbas	Longitud de Barba E	Cant. por Caja	Lbs. por 100 pzs.
1260202C	1/8	1/8-27	.69	.44	1/2	3	.46	100	2.2
1260302C	3/16	1/8-27	.98	.44	1/2	3	.75	100	2.5
1260304C		1/4-18	.98	.53	5/8	3	.75	100	4.0
1260402C	1/4	1/8-27	1.20	.44	1/2	4	.97	100	2.7
1260404C		1/4-18	1.20	.53	5/8	4	.97	100	4.3
1260406C	5/16	3/8-18	1.22	.63	3/4	4	.97	100	6.0
1260504C		1/4-18	1.20	.53	5/8	4	.97	100	4.2
1260604C	3/8	1/4-18	1.20	.53	5/8	4	.97	100	4.6
1260606C		3/8-18	1.22	.63	3/4	4	.97	50	6.4
1260608C	1/2	1/2-14	1.22	.69	15/16	4	.97	50	10.4
1260806C		3/8-18	1.22	.63	3/4	4	.97	50	7.0
1260808C	3/4	1/2-14	1.22	.69	15/16	4	.97	50	11.0
1261212C		3/4-14	1.47	.75	1-1/8	4	1.19	25	15.6

No es recomendable para agua

Serie 129

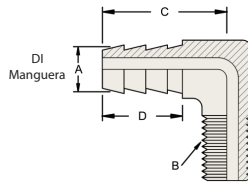

CODO 90° - INSERTO X MACHO ROSCA NPTF
Barba para manguera Macho NPTF

Número de Parte	DI manguera A	Rosca NPTF B	Longitud Línea central C	Barbas	Longitud de Barba D	Cant. por Caja	Lbs. por 100 pzs.
1290302C	3/16	1/8-27	1.05	3	.79	50	3.3
1290402C		1/8-27	1.05	3	.79	50	3.4
1290404C	1/4	1/4-18	1.14	3	.79	50	6.2
1290406C		3/8-18	1.16	3	.79	50	7.3
1290502C		1/8-27	1.05	3	.79	25	3.1
1290504C	5/16	1/4-18	1.14	3	.79	50	6.1
1290506C		3/8-18	1.16	3	.79	50	6.5
1290602C		1/8-27	1.09	3	.87	50	3.6
1290604C	3/8	1/4-18	1.14	3	.87	50	6.6
1290606C		3/8-18	1.22	3	.87	50	8.9
1290608C		1/2-14	1.29	3	.87	25	13.1
1290804C		1/4-18	1.17	3	.87	50	6.3
1290806C	1/2	3/8-18	1.24	3	.87	50	8.3
1290808C		1/2-14	1.29	3	.87	25	12.3
1291006C	5/8	3/8-18	1.31	3	.87	25	17.2
1291008C		1/2-14	1.36	3	.87	25	18.6
1291208C	3/4	1/2-14	1.36	3	.87	25	23.2
1291212C		3/4-14	1.44	3	.87	25	21.5
1291612C	1	3/4-14	1.65	4	.98	10	37.1
1291616C		1-11-1/2 ++	1.69	4	.98	10	42.5

++Roscas disminuidas

Serie 129-SS (316 inoxidable)

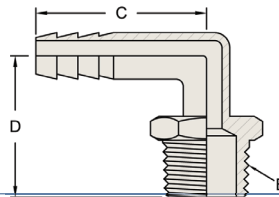

CODO 90° - INSERTO X MACHO ROSCA NPTF
Barba para Manguera a Macho NPT

Número de Parte	DI manguera A	Rosca NPT B	Longitud Línea central C	Barbas	Altura de Línea Central D	Lbs. por 100 pzs.
1290402SS	1/4	1/8-27	1.1	3	.85	3.5
1290404SS	1/4	1/4-18	1.47	4	1.11	7.0
1290604SS	3/8	1/4-18	1.25	3	1.01	7.4
1290606SS	3/8	3/8-18	1.38	3	1.17	9.3
1290804SS	1/2	1/4-18	1.45	4	1.50	6.6
1290806SS	1/2	3/8-18	1.60	4	1.25	8.8
1290808SS	1/2	1/2-14	1.64	4	1.42	12.6
1291208SS	3/4	1/2-14	1.87	4	1.45	23.6
1291212SS	3/4	3/4-14	1.96	4	1.65	21.7

Serie 134

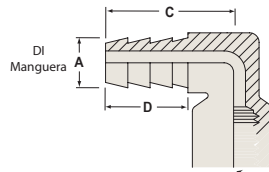

CODO A 90° - INSERTO X ROSCA HEMBRA NPTF
Barba para Manguera a Hembra NPTF

Número de Parte	DI manguera A	Rosca NPTF B	Longitud Línea central C	Barbas	Longitud de Barba D	Cant. por Caja	Lbs. por 100 pzs.
1340402C	1/4	1/8-27	1.05	3	.79	50	6.9
1340404C	1/4	1/4-18	1.14	3	.79	50	8.1
1340604C	3/8	1/4-18	1.14	3	.79	50	9.4
1340606C	3/8	3/8-18	1.22	3	.79	50	12.5
1340804C	1/2	1/4-18	1.17	3	.87	25	9.4
1340806C	1/2	3/8-18	1.24	3	.89	25	12.5
1340808C	1/2	1/2-14	1.29	3	.87	25	28.1
1341212C	3/4	3/4-14	1.52	3	.97	25	50.1

Serie 139

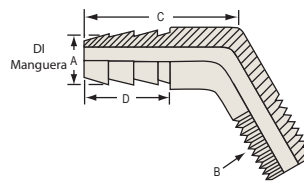

CODO 45°- INSERTO X ROSCA MACHO NPTF
Barba para Manguera a Macho NPTF

Número de Parte	DI manguera A	Rosca NPTF B	Longitud Línea central C	Barbas	Longitud de Barba D	Cant. por Caja	Lbs. por 100 pzs.
1390402C	1/4	1/8-27	.96	3	.79	100	3.4
1390404C		1/4-18	1.01	3	.79	25	6.2
1390602C	3/8	1/8-27	1.03	3	.87	100	3.6
1390604C		1/4-18	1.05	3	.87	100	6.6
1390606C		3/8-18	1.10	3	.87	25	8.9
1390804C	1/2	1/4-18	1.10	3	.87	25	6.3
1390806C		3/8-18	1.10	3	.87	25	8.3
1390808C		1/2-14	1.15	3	.87	50	12.3
1391208C		3/4	1/2-14	1.15	3	.87	25

Serie 142

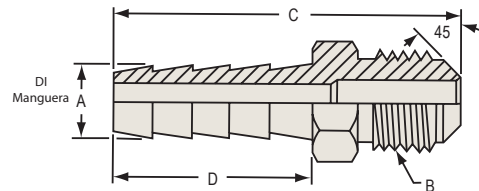

MACHO X BARBAS PARA MANGUERA
45° SAE

Número de Parte	DI manguera A	DE Tubo	Rosca UNF B	Longitud C	Hex	Barbas	Longitud de Barba D	Cant. por Caja	Lbs. por 100 pzs.
1420307C	3/16	1/4	7/16-20	1.50	7/16	3	.75	100	2.7
1420407C	1/4	1/4	7/16-20	1.72	7/16	4	.97	100	3.2
1420410C		3/8	5/8-18	1.82	5/8	4	.97	100	6.6
1420508C	5/16	5/16	1/2-20	1.75	1/2	4	.97	100	4.5
1420610C	3/8	3/8	5/8-18	1.82	5/8	4	.97	50	7.6
1420612C		1/2	3/4-16	1.97	3/4	4	.97	50	9.9
1420812C		1/2	1/2	3/4-16	1.97	3/4	4	.97	50

Serie 143

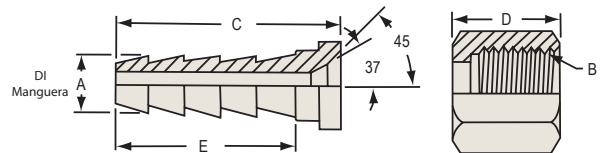
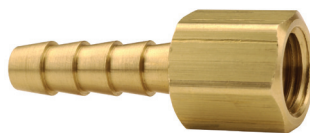

HEMBRA GIRATORIA X BARBAS PARA MANGUERA
45° SAE / 37° JIC (Doble Asiento)

Número de Parte	DI manguera A	DE Tubo	Rosca UNF B	Longitud de vástago C	Longitud de Tuerca D	Hex	Barbas	Longitud de Barba E	Cant. por Caja	Lbs. por 100 pzs.
1430307K	3/16	1/4	7/16-20	1.03	.60	9/16	3	.75	100	3.8
1430407K	1/4	1/4	7/16-20	1.25	.60	9/16	4	.97	100	4.1
1430408K		5/16	1/2-20	1.31	.68	5/8	4	.97	100	5.1
1430508K	5/16	5/16	1/2-20	1.31	.68	5/8	4	.97	100	5.1
1430612K	3/8	1/2	3/4-16	1.34	.84	7/8	4	.97	100	10.2
1430812K	1/2	1/2	3/4-16	1.34	.84	7/8	4	.97	100	10.9
1430814K		5/8	7/8-14	1.34	.96	1-1/16	4	.97	50	17.7

Serie 144

HEMBRA GIRATORIA X BARBAS PARA MANGUERA 45° SAE

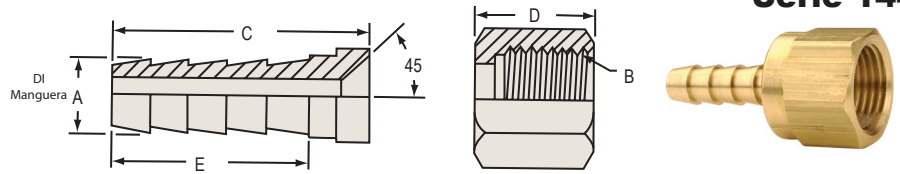

Número de Parte	DI manguera A	DE Tubo	Rosca UNF B	Longitud de Vástago C	Longitud de Tuerca D	Hex	Barbas	Longitud de Barba E	Cant. por Caja	Lbs. por 100 pzs.
1440306K	3/16	3/16	3/8-24	1.03	.45	7/16	3	.75	100	2.0
1440410K	1/4	3/8	5/8-18	1.27	.68	3/4	4	.97	100	6.7
1440510K	5/16	3/8	5/8-18	1.27	.68	3/4	4	.97	100	6.7
1440610K	3/8	3/8	5/8-18	1.27	.68	3/4	4	.97	100	7.2
1440812K	1/2	1/2	3/4-16	1.34	.84	7/8	4	.97	100	10.9
1441217K	3/4	3/4	1-1/16 - 14	1.47	1.03 *	1-1/4	4	.97	25	25.0

* Muesca en el hexágono para identificación SAE

Serie 145

HEMBRA GIRATORIA X BARBAS PARA MANGUERA 37° JIC

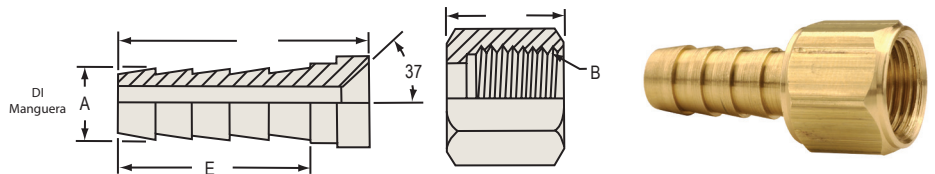

Número de Parte	DI manguera A	DE Tubo	Rosca UNF B	Longitud de Vástago C	Longitud de Tuerca D	Hex	Barbas	Longitud de Barba E	Cant. por Caja	Lbs. por 100 pzs.
1450609K	3/8	3/8	9/16-18	1.24	.63	11/16	4	.97	100	6.0
1451217K	3/4	3/4	1-1/16 - 12	1.47	1.03	1-1/4	4	.97	25	25.0

Serie 177

CODO UNIÓN 90°

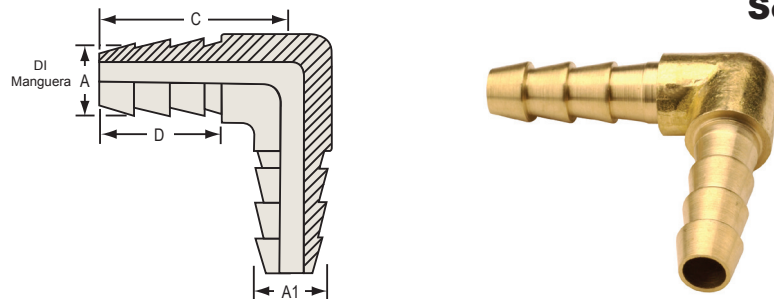

Número de Parte	DI manguera A	DI manguera A1	Longitud de Línea Central C	Barbas	Longitud de Barbas D	Cant. por Caja	Lbs. por 100 pzs.
1770202C	1/8	1/8	.73	3	.46	25	2.5
1770303C	3/16	3/16	1.05	3	.79	25	3.1
1770402C	1/4	1/8	1.05	3	.79	25	3.1
1770404C		1/4	1.05	3	.79	25	3.0
1770505C	5/16	5/16	1.15	3	.79	25	4.9
1770604C	3/8	1/4	1.15	3	.79	25	6.2
1770606C		3/8	1.15	3	.79	25	5.0
1770806C	1/2	3/8	1.25	3	.87	25	8.7
1770808C		1/2	1.25	3	.87	25	9.3
1771010C	5/8	5/8	1.30	3	.87	25	15.6
1771208C	3/4	1/2	1.41	3	.89	25	20.6
1771212C		3/4	1.41	3	.89	25	20.6

Serie 177-SS (Acero Inoxidable 304)

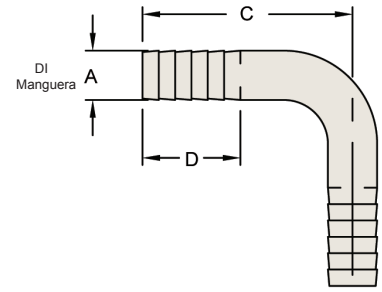

CODO UNIÓN 90°

Número de Parte	DI Manguera A	Longitud de Barba D	Longitud de Línea Central C	Barbas	Lbs. por 100 pzs.
1770202SS	1/8	.36	.85	3	0.6
1770303SS	3/16	.54	1.68	5	1.9
1770404SS	1/4	.54	1.14	5	2.5
1770606SS	3/8	.56	1.46	5	4.0
1770808SS	1/2	.58	2.24	5	8.2

Serie 178 y 178-SS (Acero Inoxidable 316)

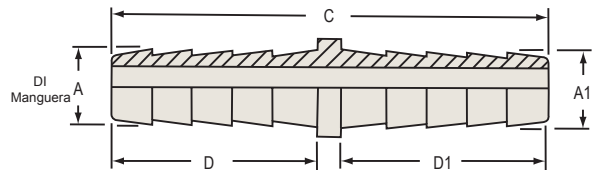

UNIÓN PARA MANGUERA

Número de Parte	SS	DI Manguera A	DI Manguera A1	Longitud C	Barbas	Longitud de Barbas D	Longitud de Barbas D1	Cant. por Caja	Lbs. por 100 pzs.
1780202C		1/8	1/8	.97	3	.46	.46	100	0.6
1780303C		3/16	3/16	1.56	3	.75	.75	100	1.3
1780402C		1/4	1/8	1.55	4	.97	.46	100	2.0
1780404C	SS	1/4	1/4	2.03	4	.97	.97	100 *	2.3
1780505C		5/16	5/16	2.06	4	.97	.97	100	2.5
1780604C		3/8	1/4	2.06	4	.97	.97	100	3.7
1780606C	SS	3/8	3/8	2.06	4	.97	.97	100 *	4.0
1780806C		1/2	3/8	2.06	4	.97	.97	100	6.2
1780808C	SS	1/2	1/2	2.06	4	.97	.97	50 *	6.5
1781006C			3/8	2.06	4	.97	.97	50	6.2
1781008C		5/8	1/2	2.06	4	.97	.97	50	6.8
1781010C			5/8	2.06	4	.97	.97	50	7.0
1781208C		3/4	1/2	2.28	4	1.19	.97	25	10.6
1781212C	SS	3/4	3/4	2.50	4	1.19	1.19	25 *	12.8
1781616C		1	1	3.00	5	1.44	1.44	10	22.5

* Para Acero Inoxidable, quitar la terminación 'C' y añadir 'SS'

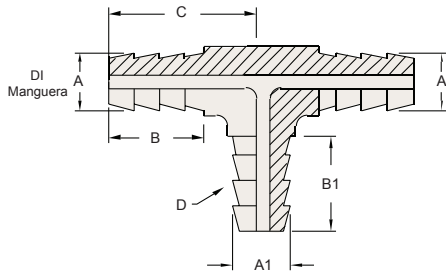

1790604C

TE UNIÓN

Número de Parte	DI Manguera A	DI Manguera A1	Longitud de Barba B	Longitud de Barba B1	Longitud de Línea Central C	Rosca NPTF	Barbas	Cant. por Caja	Lbs. por 100 pzs.
1790202C	1/8	1/8	.46	.46	.71	--	3	25	3.1
1790303C	3/16	3/16	.71	.71	.94	--	3	100	3.1
1790402C	1/4	1/8	.71	.46	.94	--	3	25	4.4
1790404C		1/4	.71	.71	.94	--	3	25	3.4
1790505C	5/16	5/16	.79	.79	1.18	--	3	25	6.4
1790604C *		--	.86	--	1.26	1/4-18	3	25	11.2
1790604BARB	3/8	1/4	.86	.71	1.26	--	3	25	6.5
1790606C		3/8	.86	.86	1.26	--	3	25	8.0
1790806C	1/2	3/8	.90	.90	1.26	--	3	25	10.0
1790808C		1/2	.86	.86	1.26	--	3	25	10.4
1791010C	5/8	5/8	.90	.90	1.33	--	3	25	15.8
1791208C	3/4	1/2	.90	.90	1.41	--	3	25	22.5
1791212C		3/4	.90	.90	1.41	--	3	20	37.0

* Como la imagen arriba.

Serie 179-SS (Acero Inoxidable 304)

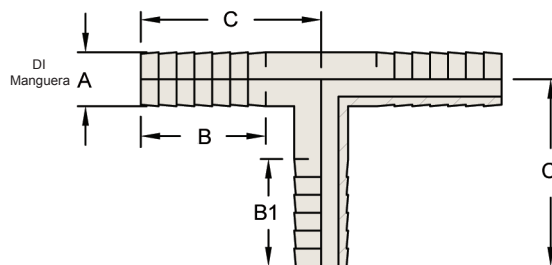

TÉ UNIÓN

Número de Parte	DI Manguera A	Longitud de Barba B	Longitud de Barba B1	Longitud de Línea Central C	Barbas	Lbs. por 100 pzs.
1790202SS	1/8	.50	.50	.62	4	1.3
1790303SS	3/16	.56	.56	.70	5	1.5
1790404SS	1/4	.63	.56 *	.94	6 / 5 *	2.5
1790606SS	3/8	.55	.55	1.01	5	3.2
1790808SS	1/2	.59	.55	1.01	5	5.6

* En caída - 5 Barbas

Conexiones Soldables para Manguera

Características:

- Dixon Brass ofrece 16 conexiones para soldar en 4 diferentes series
- Nuestras conexiones de manguera para soldadura son fabricadas con especificaciones exactas
- Todas las conexiones de manguera para soldadura están empacadas para fácil almacenamiento e identificación. Las conexiones hembra giratorias (serie 152 y 154) son vendidas en sets de vástago y tuerca giratoria. La información de costos de los componentes por separado está disponible bajo pedido.

- Se recomienda que todos los ensambles para manguera se fabriquen usando abrazaderas o férulas crimpadas en conjunto con las barbas.
- La siguiente designación de letras son comúnmente usadas para identificar conexiones de oxígeno y gas combustible:

Medida - A- 3/8-24 UNF

Medida - B 9/16-18 UNF

Serie 152

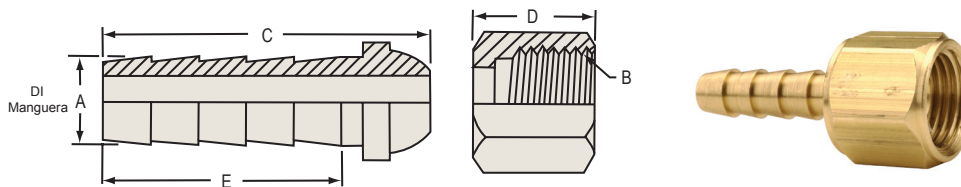

COPLES PARA OXÍGENO

Rosca mano derecha para línea de oxígeno x vástago para manguera

Número de Parte	DI Manguera A	Rosca Derecha UNF B	Longitud de Vástago C	Longitud de Tuerca D	Hex	Barbas	Longitud de Barbas E	Cant. por Caja	Lbs. por 100 pzs.
1520306K	3/16	3/8-24	1.32	.45	7/16	4	.97	100	2.3
1520309K		9/16-18	1.43	.63	11/16	4	.97	100	6.1
1520409K	1/4	9/16-18	1.43	.63	11/16	4	.97	100	6.2
1520509K	5/16	9/16-18	1.43	.63	11/16	4	.97	100	6.6
1520609K	3/8	9/16-18	1.43	.63	11/16	4	.97	100	6.9

Serie 154

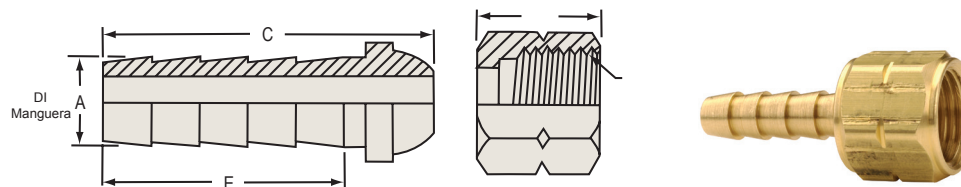

COPLES DE ACETILENO

Rosca mano izquierda para línea de acetileno x vástago para manguera

Número de Parte	DI Manguera A	Rosca Izquierda UNF B	Longitud de Vástago C	Longitud de Tuerca D	Hex	Barbas	Longitud de Barbas E	Cant. por Caja	Lbs. por 100 pzs.
1540306K	3/16	3/8-24	1.32	.45	7/16	4	.97	100	2.3
1540309K		9/16-18	1.43	.63	11/16	4	.97	100	6.1
1540409K	1/4	9/16-18	1.43	.63	11/16	4	.97	100	6.2
1540509K	5/16	9/16-18	1.43	.63	11/16	4	.97	100	6.6
1540609K	3/8	9/16-18	1.43	.63	11/16	4	.97	100	6.9

Serie 156

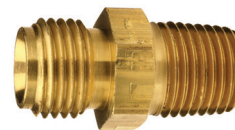
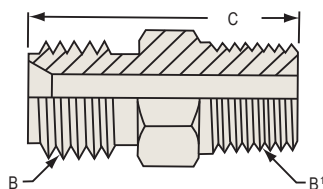

ADAPTADOR PARA OXI-ACETILENO

Rosca Mano Derecha

Número de Parte	Rosca Derecha UNF B	Rosca NPTF B'	Longitud C	Hex	Cant. por Caja	Lbs. por 100 pzs.
1560904C	9/16-18	1/4-18	1.30	5/8	100	5.8
1560906C	9/16-18	3/8-18	1.30	11/16	50	8.9

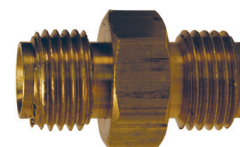
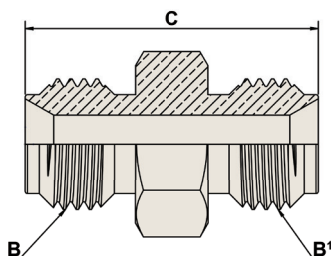

SPUD DE CONEXIÓN PARA OXI-ACETILENO

Rosca Mano Derecha

Número de Parte	Rosca Derecha UNF B	Rosca Derecha UNF B'	Longitud C	Hex	Cant. por Caja	Lbs. por 100 pzs.
1560909C	9/16-18	9/16-18	1.25	11/16	100	6.9

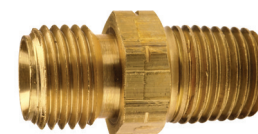
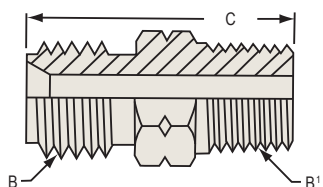

Serie 158

ADAPTADOR PARA OXI-ACETILENO

Rosca Mano Izquierda

Número de Parte	Rosca Izquierda UNF B	Rosca NPTF B'	Longitud C	Hex	Cant. por Caja	Lbs. por 100 pzs.
1580904C	9/16-18	1/4-18	1.30	5/8	100	5.8
1580906C	9/16-18	3/8-18	1.30	11/16	50	8.9

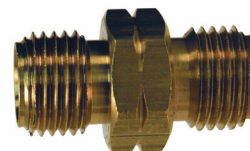
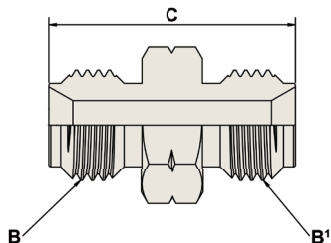

SPUD DE CONEXIÓN PARA OXI-ACETILENO

Rosca Mano Izquierda

Número de Parte	Rosca Izquierda UNF B	Rosca Izquierda UNF B'	Longitud C	Hex	Cant. por Caja	Lbs. por 100 pzs.
1580909C	9/16-18	9/16-18	1.25	11/16	100	6.9

Férulas de Latón y Prensa para Crimpar

Serie BFM

FÉRULAS PARA AIRE

Mangueras de Peso Mediano

Número de Parte	No. de Referencia.	DI Férula	Longitud de Férula	Tamaño Agujero	Calibre	Cant. por Caja	Lbs. por 100 pzs.
BFM478	4750	.478"	11/16"	21/64"	.024"	50	
BFM500	7322	.500"	1"	11/32"	.024"	50	
BFM525	7323	.525"	1"	3/8"	.024"	50	
BFM531	7324	.531"	1"	7/16"	.024"	50	
BFM562	7325	.562"	1"	7/16"	.024"	50	
BFM593	7326	.593"	1"	7/16"	.024"	50	
BFM625	7327	.625"	1"	7/16"	.024"	50	
BFM656	7328	.656"	1"	7/16"	.024"	50	
BFM687	7329	.687"	1"	1/2"	.024"	50	
BFM718	7330	.718"	1"	5/8"	.024"	50	
BFM718B	7330B	.718"	1"	1/2"	.024"	50	
BFM750	7331	.750"	1"	5/8"	.024"	50	
BFM750B	7331B	.750"	1"	1/2"	.024"	50	
BFM781	7332	.781"	1"	5/8"	.024"	50	
BFM781B	7332B	.781"	1"	1/2"	.024"	50	
BFM812	7333	.812"	1"	5/8"	.024"	50	

Serie BFL

FÉRULAS PARA AIRE

Mangueras de Peso Liviano

Número de Parte	No. de Referencia.	DI Férula	Longitud de Férula	Tamaño Agujero	Calibre	Cant. por Caja	Lbs. por 100 pzs.
BFL380	622	.380"	1/2"	17/64"	.016"	50	
BFL400	619	.400"	15/32"	17/64"	.020"	50	
BFL410	620	.410"	1/2"	17/64"	.016"	50	
BFL450	769	.450"	9/16"	11/32"	.016"	50	
BFL500	624	.500"	1/2"	11/32"	.016"	50	
BFL525	625	.525"	1/2"	11/32"	.016"	50	
BFL548	626	.548"	31/64"	3/8"	.015"	50	
BFL564	3588	.564"	3/4"	3/8"	.019"	50	
BFL575	KK	.575"	31/64"	15/32"	.019"	50	
BFL600	JJ	.600"	1/2"	1/2"	.019"	50	
BFL625	II	.625"	1/2"	1/2"	.019"	50	
BFL650	HH	.650"	1/2"	1/2"	.019"	50	
BFL625	GG	.675"	33/64"	1/2"	.019"	50	
BFL725	EE	.725"	17/32"	1/2"	.019"	50	
BFL750	DD	.750"	17/32"	1/2"	.019"	50	
BFL775	CC	.775"	17/32"	1/2"	.016"	50	

Serie BFMW

FÉRULAS PARA FLUIDOS

Mangueras para Agua de peso mediano

Número de Parte	No. de Referencia.	DI Férula	Longitud de Férula	Tamaño Agujero	Calibre	Cant. por Caja	Lbs. por 100 pzs.
BF800	---	.800"	.844"	.688"	.024"	25	
BF825	---	.825"	.844"	.688"	.024"	25	
BF850	Z	.850"	.568"	.688"	.019"	25	
BFW875	7244A	.875"	.844"	.688"	.024"	25	
BFW900	5029A	.900"	.844"	.688"	.024"	25	
BFW925	7113	.925"	.840"	.690"	.025"	25	
BFW975	5028A	.975"	.844"	.688"	.024"	25	
BFW1025	7114A	1.025"	.844"	.693"	.024"	25	
BFW1175	7088A	1.175"	.844"	.875"	.024"	25	
BFMW1050	3605	1.050"	.625"	.750"	.025"	25	
BFMW1100	5027	1.100"	.843"	.812"	.023"	25	
BFMW1150	7104A	1.150"	.844"	.880"	.024"	25	
BFMW1225	875-K	1.225"	.875"	.875"	.025"	25	
BFMW1275	875-1	1.275"	.875"	1.000"	.025"	25	
BFMW1400	D	1.400"	.687"	1.120"	.020"	25	
BFMW1500	1500	1.500"	.875"	1.120"	.025"	25	

SERIE 856
PRENSA MANUAL PARA FÉRULAS DE MANGUERA



Características:

- Calidad profesional, brinda producción en montaje fijo o en sitio
- Se envía con 5 dados para mangueras de trenza sencilla 1/4" a doble trenza de 3/8"
- Dados opcionales para mangueras de 3/16" y 1/2"

# de Parte Opcional	DI Dado*	DE Manguera **
856-10	.375	.385 - .406
856-8	.750	.760 - .781
856-9	.812	.820 - .843

# de Parte Estándar	DI Dado *	DE Manguera**
856-1	.625	.640 - .671
856-2	.578	.590 - .625
856-3	.531	.540 - .562
856-4	.484	.490 - .520
856-5	.687	.690 - .710

* Verifica el Diámetro Interior de la Manguera

** Diámetro con inserto barbado instalado

Conexiones para Manguera Reutilizables

Aplicaciones:

Las conexiones reutilizables son usadas cuando se requiere una conexión de manguera mas resistente o se considera hacer una reparación considerable.

Características:

- Dixon Brass brinda hasta 110 conexiones reutilizables en 10 diferentes series.
- Todas las conexiones reutilizables son de construcción para trabajo pesado

Tres variables deben considerarse antes de ordenar

1. **Diámetro Interior de la manguera que se usará con la conexión**
2. **Diámetro Exterior de la manguera que se usará con la conexión**
3. **La medida de la rosca para la conexión deseada**

Los números de parte de los sets de conexiones reutilizables para manguera (183, 185 y 187) son de fácil compresión y uso. Los tres primeros dígitos del número de parte especifican la serie. El cuarto dígito es el diámetro interior de la manguera usada con la conexión (medida en dieciseisavos de pulgada). El quinto y sexto dígito significan el diámetro exterior de la manguera usado en la conexión (medida en dieciseisavos de pulgada).

Nota: Recomendado para mangueras con cubierta de hule solamente

Como Usar los Números de Parte de las Conexiones Reutilizables Dixon Brass

1836116

1836116

1836116

1836116

IDENTIFICACIÓN DE SERIE

I.D. DE MANGUERA (Medida en dieciseisavos de pulgada)

D.E. DE MANGUERA (Medida en dieciseisavos de pulgada)

MEDIDA DE ROSCA (Medida en dieciseisavos de pulgada)

Como Instalar Conexiones Reutilizables sin Crimpar y Reducir el Contorno de Manguera.

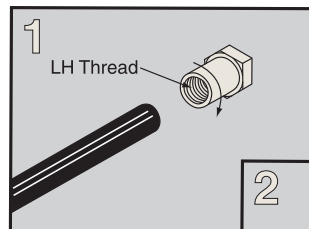

1
 Simplemente deslice y gire la férula en el extremo que ha sido cortado. No es necesario reducir su contorno.

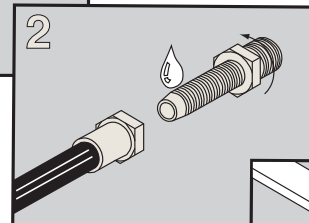

2
 Aplique una o dos gotas de lubricante en la conexión antes de instalar la férula.

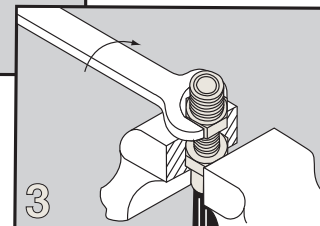

3
 Gira la conexión reutilizable dentro de la férula. La manguera se expande dentro de la férula para embonar perfectamente.

Serie 180 y 180-SS

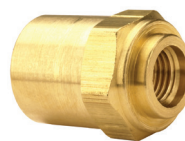
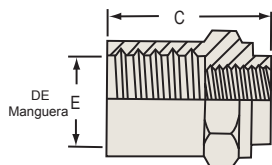

FÉRULA REUTILIZABLE

Número de Parte Latón	SS 303	DI Manguera	DE Manguera E	Longitud C	Hex	Cant. por Caja	Lbs. por 100 pzs.
1800408F	SS		1/2	1.02	11/16	100 *	5.3
1800409F	SS	1/4	9/16	1.02	3/4	50 *	6.3
1800410F	SS		5/8	1.02	13/16	50 *	7.3
1800509F	SS		9/16	1.10	3/4	100 *	6.6
1800510F	SS	5/16	5/8	1.10	13/16	50 *	7.8
1800511F	SS		11/16	1.10	7/8	50	8.6
1800610F	SS		5/8	1.10	13/16	50 *	7.2
1800611F	SS	3/8	11/16	1.10	7/8	50 *	8.3
1800612F	SS		3/4	1.10	7/8	50 *	6.7
1800814F	SS		7/8	1.69	1-1/16	25 *	15.8
1800815F	SS	1/2	15/16	1.69	1-1/8	25 *	17.5
1800816F	SS		1	1.69	1-3/16	20	19.5

* Para Acero Inoxidable añadir 'SS'

Serie 182 y 182-SS

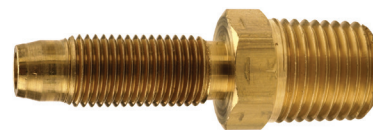
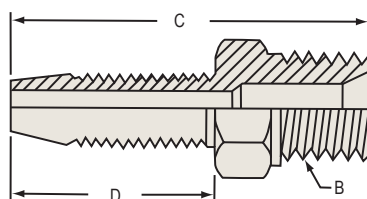

VÁSTAGO MACHO REUTILIZABLE

Número de Parte Latón	303 SS	DI Manguera	Rosca NPTF ** B	Longitud C	Longitud de vástago D	Hex	Cant. por Caja	Lbs. por 100 pzs.
1820402S	SS		1/8-27	1.68	1.07	9/16	100 *	4.1
1820404S	SS	1/4	1/4-18	1.86	1.07	9/16	100 *	5.1
1820406S	SS		3/8-18	1.86	1.07	11/16	50	6.5
1820504S	SS		1/4-18	1.96	1.17	9/16	50 *	5.5
1820506S	SS	5/16	3/8-18	1.96	1.17	11/16	50	6.9
1820604S	SS		1/4-18	1.96	1.17	9/16	100 *	6.4
1820606S	SS	3/8	3/8-18	1.96	1.17	11/16	50 *	7.8
1820608S	SS		1/2-14	2.17	1.17	7/8	25	12.7
1820804S	SS		1/4-18	2.43	1.64	11/16	50	12.3
1820806S	SS	1/2	3/8-18	2.43	1.64	11/16	50 *	11.0
1820808S	SS		1/2-14	2.64	1.64	7/8	25 *	16.3

* Para Acero Inoxidable, quitar la terminación 'S' y añadir 'SS'

** Rosca NPT en 182-SS

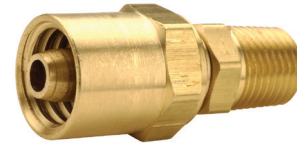
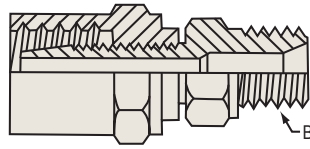

CONEXIÓN MACHO REUTILIZABLE - DESENSAMBLADA

Número de Parte Latón	303 SS	DI Manguera	DE Manguera	Rosca NPTF ** B	Vástago Hex	Férula Hex	Cant. por Caja	Lbs. por 100 pzs.
1834082K	SS		1/2	1/8-27	9/16	11/16	100 *	9.4
1834092K	SS	1/4	9/16	1/8-27	9/16	3/4	100 *	10.5
1834102K	SS		5/8	1/8-27	9/16	13/16	100 *	11.4
1834084K	SS		1/2	1/4-18	9/16	11/16	50 *	10.4
1834094K	SS	1/4	9/16	1/4-18	9/16	3/4	50 *	11.4
1834104K	SS		5/8	1/4-18	9/16	13/16	50 *	12.3
1834086K			1/2	3/8-18	11/16	11/16	50	11.8
1834096K		1/4	9/16	3/8-18	11/16	3/4	50	12.8
1834106K			5/8	3/8-18	11/16	13/16	50	13.8
1835094K	SS		9/16	1/4-18	9/16	3/4	50 *	12.1
1835104K	SS	5/16	5/8	1/4-18	9/16	13/16	50 *	13.4
1835114K			11/16	1/4-18	9/16	7/8	50	14.1
1835096K			9/16	3/8-18	11/16	3/4	50	13.5
1835106K		5/16	5/8	3/8-18	11/16	13/16	50	14.7
1835116K			11/16	3/8-18	11/16	7/8	50	15.5
1836104K	SS		5/8	1/4-18	9/16	13/16	50 *	13.6
1836114K	SS	3/8	11/16	1/4-18	9/16	7/8	50 *	14.7
1836124K	SS		3/4	1/4-18	9/16	7/8	50 *	13.1
1836106K	SS		5/8	3/8-18	11/16	13/16	50 *	15.0
1836116K	SS	3/8	11/16	3/8-18	11/16	13/16	50 *	16.1
1836126K	SS		3/4	3/8-18	11/16	7/8	50 *	14.6
1836108K			5/8	1/2-14	7/8	13/16	50	19.9
1836118K		3/8	11/16	1/2-14	7/8	7/8	50	21.0
1836128K			3/4	1/2-14	7/8	7/8	50	19.4
1838144K			7/8	1/4-18	11/16	1-1/16	25	28.1
1838154K		1/2	15/16	1/4-18	11/16	1-1/8	25	29.8
1838164K			1	1/4-18	11/16	1-3/16	25	31.8
1838146K	SS		7/8	3/8-18	11/16	1-1/16	25 *	26.8
1838156K	SS	1/2	15/16	3/8-18	11/16	1-1/8	25 *	28.5
1838166K			1	3/8-18	11/16	1-3/16	25	30.5
1838148K	SS		7/8	1/2-14	7/8	1-1/16	20 *	32.1
1838158K	SS	1/2	15/16	1/2-14	7/8	1-1/8	20 *	33.8
1838168K			1	1/2-14	7/8	1-3/16	20	35.8

* Para Acero Inoxidable, añadir la terminación 'SS'

** Rosca NPT en 183-SS

Serie 184

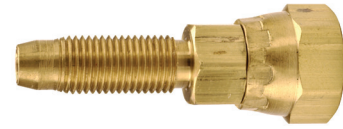
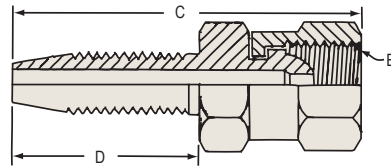

**HEMBRA GIRATORIA REUTILIZABLE
VÁSTAGO NPSM**

Número de Parte	DI Manguera A	Rosca NPSM B	Longitud C	Longitud de vástago D	Giratoria Hex	Cant. por Caja	Lbs. por 100 pzs.
1840404A	1/4	1/4-18	1.94	1.07	11/16	50	7.8
1840406A		3/8-18	2.07	1.07	13/16	50	11.3
1840504A	5/16	1/4-18	2.12	1.17	11/16	50	9.4
1840604A	3/8	1/4-18	2.12	1.17	11/16	50	9.1
1840606A		3/8-18	2.20	1.17	13/16	50	12.5
1840808A	1/2	1/2-14	2.86	1.64	15/16	25	19.0

Serie 185

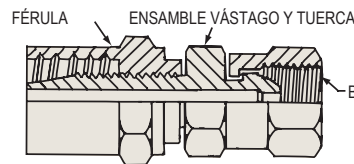

HEMBRA GIRATORIA REUTILIZABLE

Número de Parte	DI Manguera A	DE Manguera	Rosca NPSM B	Giratoria Hex	Férula Hex	Cant. por Caja	Lbs. por 100 pzs.
1854084K	1/4	1/2	1/4-18	11/16	11/16	50	13.2
1854094K		9/16	1/4-18	11/16	3/4	50	14.2
1854104K		5/8	1/4-18	11/16	13/16	50	15.1
1854086K	1/4	1/2	3/8-18	13/16	11/16	50	16.6
1854096K		9/16	3/8-18	13/16	3/4	50	17.6
1854106K		5/8	3/8-18	13/16	13/16	50	18.6
1855094K	5/16	9/16	1/4-18	11/16	3/4	50	16.0
1855104K		5/8	1/4-18	11/16	13/16	50	17.3
1855114K		11/16	1/4-18	11/16	7/8	50	18.0
1856104K	3/8	5/8	1/4-18	11/16	13/16	50	16.3
1856114K		11/16	1/4-18	11/16	7/8	50	17.4
1856124K		3/4	1/4-18	11/16	7/8	50	15.8
1856106K	3/8	5/8	3/8-18	13/16	13/16	50	19.7
1856116K		11/16	3/8-18	13/16	7/8	50	20.8
1856126K		3/4	3/8-18	13/16	7/8	50	19.3
1858148K	1/2	7/8	1/2-14	15/16	1-1/16	20	34.8
1858158K		15/16	1/2-14	15/16	1-1/8	20	36.5
1858168K		1	1/2-14	15/16	1-3/16	20	38.5

Serie 186

VÁSTAGO UNIÓN REUTILIZABLE

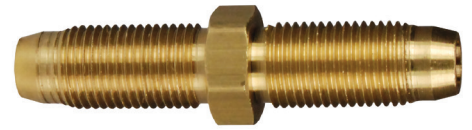
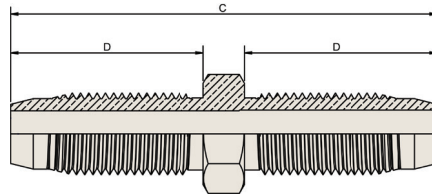

Número de Parte	DI Manguera	Longitud C	Longitud de Vástago	Hex	Cant. por Caja	Lbs. por 100 pzs.
1860404S	1/4	2.39	1.07	9/16	100	6
1860606S	3/8	2.59	1.17	5/8	50	9

Serie 187

UNIÓN REUTILIZABLE PARA MANGUERA

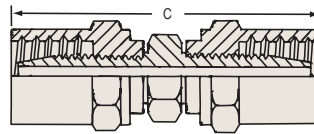

Número de Parte	DI Manguera	DE Manguera	Longitud C	Unión Hex	Férula Hex	Cant. por Caja	Lbs. por 100 pzs.
1870408K	1/4	1/2	2.39	9/16	11/16	50	16.2
1870409K		9/16	2.39	9/16	3/4	50	18.2
1870410K		5/8	2.39	9/16	13/16	50	20.1
1870610K	3/8	5/8	2.59	5/8	13/16	25	23.1
1870611K		11/16	2.59	5/8	7/8	25	25.5
1870612K		3/4	2.59	5/8	7/8	25	22.3

Serie 268B

CONEXIÓN CON ESPIGA

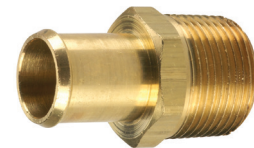
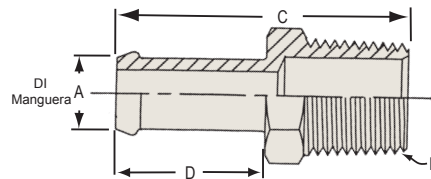

Número de Parte	DI Manguera A	Rosca NPTF B	Longitud C	Hex	Longitud de Barba D	Cant. por Caja	Lbs. por 100 pzs.
268B0402	1/4	1/8-27	1.18	1/2	.62	100	2.4
268B0404		1/4-18	1.41	9/16	.62	100	3.6
268B0502	5/16	1/8-27	1.22	1/2	.62	100	2.5
268B0504		1/4-18	1.41	9/16	.62	50	3.9
268B0602	3/8	1/8-27	1.48	1/2	.88	100	3.7
268B0604		1/4-18	1.67	9/16	.88	100	4.4
268B0606		3/8-18	1.67	11/16	.88	50	5.8
268B0806	1/2	3/8-18	1.67	11/16	.88	50	6.1
268B0808		1/2-14	1.88	7/8	.88	50	10.9
268B1008	5/8	1/2-14	1.88	7/8	.88	25	11.9
268B1208	3/4	1/2-14	1.88	7/8	.88	50	13.7
268B1212		3/4-14	1.88	1-1/16	.88	25	15.4

Conexiones de Manguera Lok-on

Conexiones de Manguera Lok-on

Instrucciones de ensamble

1. Corte el extremo de la manguera a escuadra y sin rebaba.
2. Lubrique ya sea la conexión Push-On, la manguera o ambas.
3. Inserte la conexión Push-On en la manguera hasta que la primera barba del vástago esté en la manguera.
4. Coloque el extremo de la conexión contra un objeto plano (banco, pared, etc.) y sujete la manguera a una pulgada del extremo. Empuje con fuerza constante hasta que el extremo de la manguera es cubierto por la tapa amarilla de plástico.

Instrucciones para Desensamblar

1. Deje la conexión Push-On en su lugar, haga un corte de 1" en la manguera a lo largo del extremo barbado (espiga) de la conexión. Nota: tenga cuidado de no lastimar la espiga barbada cuando corte la manguera.
2. Con una sujeción firme en la manguera, dé un fuerte jalón hacia abajo para liberar la conexión de la manguera.



- PRECAUCIÓN: Las conexiones Push-On se sujetarán correctamente a la manguera Push-On solo cuando se empuje la manguera totalmente hasta el fondo, en el extremo cortado de la manguera oculto por la tapa de plástico amarillo.

Herramienta para Ensamble de Conexión Push-On 270AT

Características:

- Corta la manguera estilo Push-On e inserta la conexión.
- Cortador integrado para manguera Push-On con D.I. de 1/4" a 3/4". Corta sin deshilar la manguera.
- La herramienta cuenta con cuatro agujeros de 7/16" para montaje en el banco de trabajo.
- Fije y sujete la manguera en el banco de la herramienta y aplique presión ligeramente en la manija para introducir la conexión.
- Tamaño: 13-1/2" de largo x 2-3/8" de ancho x 7" de alto.



Número de Parte	Descripción
270AT-RPLBlade	Cuchilla de reemplazo para 270AT

271 Series

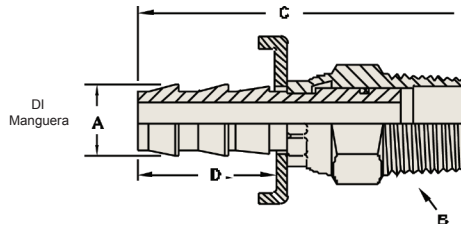

MACHO NPTF GIRATORIO

National Pipe Tapered - Dryseal

Número de Parte	DI Manguera A	Rosca NPTF B	Longitud C	Hex	Barbas	Longitud de Barba D	Cant. por Caja	Lbs. por 100 pzs.
2710402C	1/4	1/8-27	2.09	9/16	2	.81	100	6.8
2710404C		1/4-18	2.02	9/16	2	.87	100	6.1
2710604C	3/8	1/4-18	2.12	9/16	2	.97	50	7.4
2710606C		3/8-18	2.12	11/16	2	.97	50	9.1
2710806C	1/2	3/8-18	2.12	11/16	2	.97	25	10.4
2710808C		1/2-14	2.33	7/8	2	.97	20	14.8
2711212C	3/4	3/4-14	2.80	1-1/16	3	1.45	10	24.8

Nota: La rosca giratoria es únicamente para comodidad en el montaje. **máximo 120 PSI**

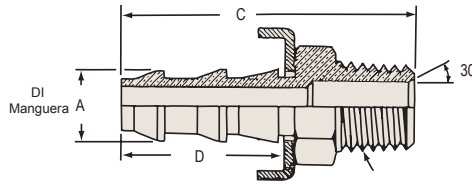

MACHO NPTF RÍGIDO

National Pipe Tapered - Dryseal

Número de Parte	303 SS	DI Manguera A	Rosca NPTF ** B	Longitud C	Hex	Barbas	Longitud de Barbas D	Cant. por Caja	Lbs. por 100 pzs.
2720402C	SS		1/8-27	1.42	7/16	2	.77	100 *	2.7
2720404C	SS	1/4	1/4-18	1.61	9/16	2	.77	100 *	4.3
2720406C			3/8-18	1.61	11/16	2	.77	50	5.6
2720502C		5/16	1/8-27	1.42	7/16	2	.77	100	3.1
2720504C			1/4-18	1.61	9/16	2	.77	50	4.5
2720602C			1/8-27	1.60	9/16	2	.92	50	5.0
2720604C	SS		1/4-18	1.76	9/16	2	.92	50 *	5.3
2720606C	SS	3/8	3/8-18	1.76	11/16	2	.92	50 *	6.7
2720608C			1/2-14	1.97	7/8	2	.92	25	11.0
2720612C			3/4-14	1.97	1-1/16	2	.92	25	15.6
2720804C	SS		1/4-18	1.86	11/16	2	1.02	25	8.6
2720806C	SS	1/2	3/8-18	1.86	11/16	2	1.02	50 *	7.1
2720808C	SS		1/2-14	2.07	7/8	2	1.02	25 *	11.9
2720812C			3/4-14	2.07	1-1/16	2	1.02	25	16.3
2721006C			3/8-18	2.34	3/4	3	1.50	25	12.0
2721008C		5/8	1/2-14	2.55	7/8	3	1.50	25	14.3
2721012C			3/4-14	2.55	1-1/16	3	1.50	25	19.0
2721208C	SS	3/4	1/2-14	2.55	7/8	3	1.50	25 *	20.0
2721212C	SS		3/4-14	2.55	1-1/16	3	1.50	20 *	19.4
2721612C		1	3/4-14	2.93	1-1/4	3	1.50	10	43.7
2721616C	SS		1 - 11-1/2++	3.11	1-3/8	3	1.50	5 *	49.4

• Agregue el sufijo "BC" al # de parte para la opción con tapa de latón. No disponible para 5/16".

* Para Acero Inoxidable, quitar la terminación 'C' y añadir 'SS'

** Rosca NPT en 272-SS

++rosca disminuida



Serie 272W

Tapa Amarilla Push-On

Número de Parte	DI Manguera	Cant. por Caja. *
2720400W	1/4	100
2720500W	5/16	100
2720600W	3/8	100
2720800W	1/2	100
2721000W	5/8	50
2721200W	3/4	50
2721600W	1	25

• Vendido en cajas por cantidad solamente.

Conexiones de Manguera Lok-On

Serie 273

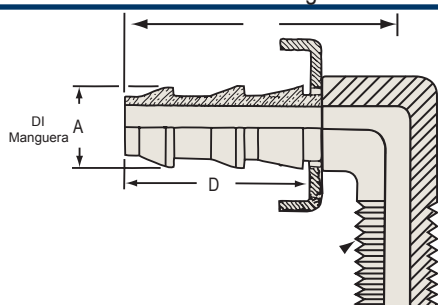

CODO 90° MACHO NPTF -
National Pipe Tapered - Dryseal

Número de Parte	DI Manguera A	Rosca NPTF B	Longitud de Línea Central C	Barbas	Longitud de Barbas D	Cant. por Caja	Lbs. por 100 pzs.
2730402C	1/4	1/8-27	1.22	2	.82	100	3.7
2730404C		1/4-18	1.40	2	.82	50	6.4
2730602C	3/8	1/8-27	1.35	2	.92	50	4.3
2730604C		1/4-18	1.40	2	.92	50	7.8
2730606C		3/8-18	1.51	2	.92	25	9.5
2730806C	1/2	3/8-18	1.54	2	1.02	25	13.2
2730808C		1/2-14	1.61	2	1.02	25	17.1
2731208C	3/4	1/2-14	2.15	3	1.50	10	25.3
2731212C		3/4-14	2.23	3	1.50	10	28.1

Serie 274

HEMBRA NPT RÍGIDA
National Pipe Tapered - Dryseal

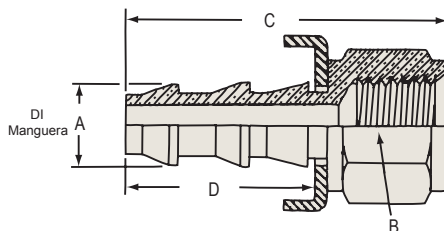

Número de Parte	DI Manguera A	Rosca NPTF B	Longitud C	Hex	Barbas	Longitud de Barbas D	Cant. por Caja	Lbs. por 100 pzs.
2740402C	1/4	1/8-27	1.32	1/2	2	.82	100	2.8
2740404C		1/4-18	1.51	5/8	2	.82	100	4.7
2740406C		3/8-18	1.51	3/4	2	.82	50	5.6
2740502C	5/16	1/8-27	1.32	1/2	2	.82	100	3.4
2740504C		1/4-18	1.51	5/8	2	.82	50	4.9
2740602C	3/8	1/8-27	1.47	9/16	2	.97	50	5.6
2740604C		1/4-18	1.66	5/8	2	.97	50	5.5
2740606C		3/8-18	1.66	3/4	2	.97	50	6.5
2740608C		1/2-14	1.66	15/16	2	.97	50	12.0
2740612C		3/4-14	1.97	1-3/16	2	.97	25	20.0
2740804C		1/2	1/4-18	1.76	11/16	2	1.07	50
2740806C	3/8-18		1.76	3/4	2	1.07	50	7.4
2740808C	1/2-14		1.76	15/16	2	1.07	25	10.0
2740812C	3/4-14		2.07	1-3/16	2	1.07	25	20.2
2741006C	5/8	3/8-18	2.24	3/4	3	1.55	25	10.0
2741008C		1/2-14	2.24	15/16	3	1.55	25	11.0
2741012C		3/4-14	2.55	1-3/16	3	1.55	25	23.0
2741208C	3/4	1/2-14	2.24	15/16	3	1.55	25	13.7
2741212C		3/4-14	2.55	1-3/16	3	1.55	20	23.5
2741612C	1	3/4-14	2.55	1-3/16	3	1.55	10	25.5
2741616C		1 - 11-1/2	2.68	1-7/16	3	1.55	10	37.5

• Añade 'BC' al final de número de parte para la opción de tapa de latón. No disponible para DI de 5/16".

Características:

- Fácil ensamble, sin necesidad de abrazaderas o férulas
- Estas conexiones deben ser usadas con manguera estilo Push-On SOLAMENTE.



Serie 572

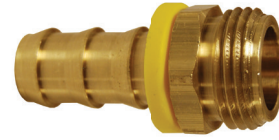
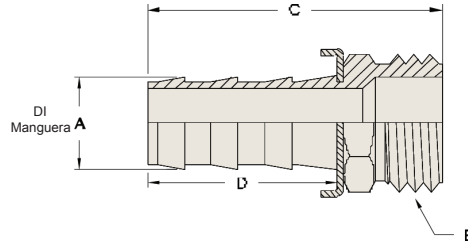

Conexión Macho para Manguera de Jardín Push-On

Número de Parte	DI Manguera A	Rosca NH B	Longitud C	Hex	Barbas	Longitud de Barba D	Cant. por Caja	Lbs. por 100 pzs.
5720812C	1/2	3/4-11-1/2	1.83	1-1/16	2	1.02	25	12.3
5721012C	5/8	3/4-11-1/2	2.29	1-1/16	3	1.50	25	14.5
5721212C	3/4	3/4-11-1/2	2.29	1-1/16	3	1.50	25	15.1

Serie 574

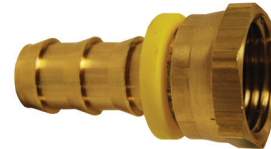
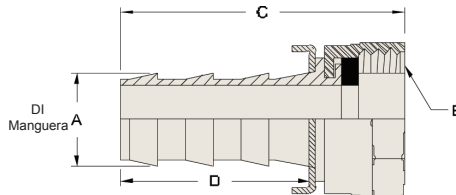

Conexión Hembra para Manguera de Jardín Push-On

Número de Parte	DI Manguera A	Rosca NH B	Longitud C	Hex	Barbas	Longitud de Barba D	Cant. por Caja	Lbs. por 100 pzs.
5740812C	1/2	3/4-11-1/2	1.79	1-3/16	2	1.02	25	11.5
5741012C	5/8	3/4-11-1/2	2.25	1-3/16	3	1.50	25	12.2
5741212C	3/4	3/4-11-1/2	2.25	1-3/16	3	1.50	25	13.5

Serie 575

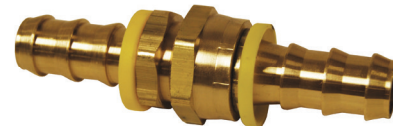
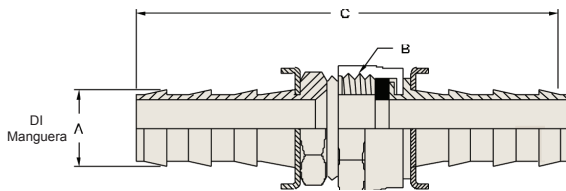

Set de Conexiones Push-On para Manguera de Jardín - no ensamblado

Número de Parte	DI Manguera A	Rosca NH B	Longitud C	Barbas	Cant. por Caja	Lbs. por 100 pzs.
5750808K	1/2	3/4-11-1/2	3.28	2	25	23.8
5751010K	5/8	3/4-11-1/2	4.23	3	25	26.7
5751212K	3/4	3/4-11-1/2	4.23	3	25	28.6

Serie 278

HEMBRA NPSM GIRATORIA

National Pipe Straight - Tipo Asiento de Bola

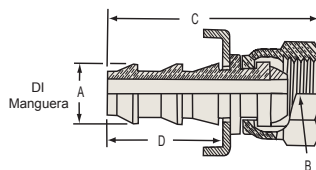

Número de Parte	DI Manguera A	Rosca NPSM B	Longitud C	Hex	Barbas	Longitud de Barbas D	Cant. por Caja	Lbs. por 100 pzs.
2780402C		1/8-27	1.39	1/2	2	.77	100	3.1
2780404C	1/4	1/4-18	1.47	11/16	2	.77	50	5.9
2780406C		3/8-18	1.40	11/16	2	.77	50	8.5
2780604C		1/4-18	1.61	11/16	2	.92	50	7.3
2780606C	3/8	3/8-18	1.75	13/16	2	.92	50	9.1
2780608C		1/2-14	1.79	15/16	2	.97	25	10.5
2780808C		1/2-14	1.88	15/16	2	1.02	50	11.7
2780812C	1/2	3/4-14	2.36	1-3/16	2	1.02	25	18.0
2781012C	5/8	3/4-14	2.36	1-3/16	3	1.50	25	19.4
2781212C	3/4	3/4-14	2.36	1-3/16	3	1.50	20	21.3

• Añade 'BC' al final de número de parte para la opción de tapa de latón.

Serie 280

HEMBRA NPSM GIRATORIA

National Pipe Straight - Tipo Asiento de Arandela

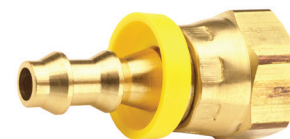
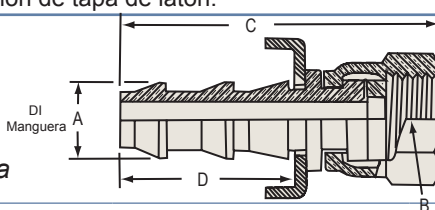

Número de Parte	DI Manguera A	Rosca NPSM B	Longitud C	Hex	Barbas	Longitud de Barbas D	Cant. por Caja	Lbs. por 100 pzs.
2800402C		1/8-27	1.39	1/2	2	.77	100	2.9
2800404C	1/4	1/4-18	1.47	11/16	2	.77	100	5.4
2800604C		1/4-18	1.61	11/16	2	.92	50	7.0
2800606C	3/8	3/8-18	1.75	13/16	2	.92	50	8.6
2800608C		1/2-14	1.80	15/16	2	.92	50	9.4
2800808C	1/2	1/2-14	1.88	15/16	2	1.02	25	10.8
2801008C	5/8	1/2-14	2.36	15/16	3	1.50	25	17.8
2801212C	3/4	3/4-14	2.36	1-3/16	3	1.50	20	18.3

• Añade 'BC' al final de número de parte para la opción de tapa de latón.

• **No se recomienda su uso con agua**

Serie 282

MACHO RÍGIDO

45° SAE

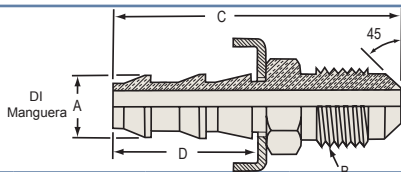

Número de Parte	DI Manguera A	DE Tubo	Rosca UNF B	Longitud C	Hex	Barbas	Longitud de Barbas D	Cant. por Caja	Lbs. por 100 pzs.
2820407C		1/4	7/16-20	1.50	7/16	2	.77	100	3.0
2820408C	1/4	5/16	1/2-20	1.59	1/2	2	.77	100	4.0
2820610C	3/8	3/8	5/8-18 *	1.83	5/8	2	.92	50	7.4
2820812C	1/2	1/2	3/4-16	2.12	3/4	2	1.02	50	11.5
2821014C	5/8	5/8	7/8-14	2.73	7/8	3	1.50	25	19.4
2821217C	3/4	3/4	1 - 1/16-14 *	2.98	1-1/16	3	1.50	25	32.0

* Muesca en el hexágono para identificación SAE

• Añade 'BC' al final de número de parte para la opción de tapa de latón.

Serie 284

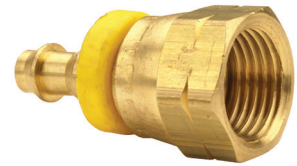
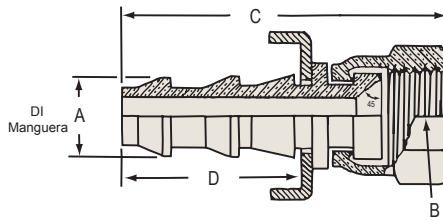

HEMBRA GIRATORIA
45° SAE

Número de Parte	DI Manguera A	DE Tubo	Rosca UNF B	Longitud C	Hex	Barbas	Longitud de Barbas D	Cant. por Caja	Lbs. por 100 pzs.
2840410C	1/4	3/8	5/8-18 *	1.60	3/4	2	.77	50	6.6
2840510C	5/16	3/8	5/8-18 *	1.60	3/4	2	.77	50	6.7
2840610C	3/8	3/8	5/8-18 *	1.75	3/4	2	.92	50	7.1
2841217C	3/4	3/4	1 - 1/16-14 *	2.54	1-1/4	3	1.50	10	26.7

- * Muesca en el hexágono para identificación SAE
- Añade 'BC' al final de número de parte para la opción de tapa de latón. No disponible para DI de 5/16".

Serie 286

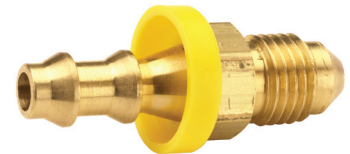
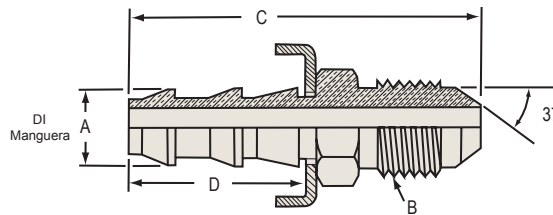

MACHO RÍGIDO
37° JIC

Número de Parte	DI Manguera A	DE Tubo	Rosca UNF B	Longitud C	Hex	Barbas	Longitud de Barbas D	Cant. por Caja	Lbs. por 100 pzs.
2860407C		1/4	7/16-20	1.59	1/2	2	.77	100	3.4
2860408C	1/4	5/16	1/2-20	1.59	5/8	2	.77	50	4.6
2860409C		3/8	9/16-18	1.63	5/8	2	.77	100	5.1
2860609C	3/8	3/8	9/16-18	1.78	5/8	2	.92	50	5.9
2860812C	1/2	1/2	3/4-16	1.98	7/8	2	1.02	25	11.8
2861014C	5/8	5/8	7/8-14	2.62	15/16	3	1.50	25	18.5
2861217C	3/4	3/4	1 - 1/16-12 *	2.79	1-1/8	3	1.50	10	29.0

- * Rosca UN
- Añade 'BC' al final de número de parte para la opción de tapa de latón.

Serie 287

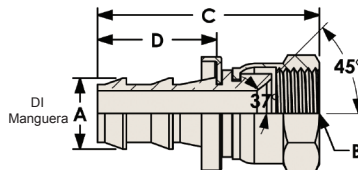

HEMBRA GIRATORIA
45° SAE / 37° JIC (doble asiento)

Número de Parte	303 SS	DI Manguera A	DE Tubo	Rosca UNF B	Longitud C	Hex	Barbas	Longitud de Barbas D	Cant. por Caja	Lbs. por 100 pzs.
2870407C	SS	1/4	1/4	7/16-20	1.50	9/16	2	.77	100 *	3.8
2870408C		5/16	5/16	1/2-20	1.60	5/8	2	.77	100	5.1
2870608C		3/8	5/16	1/2-20	1.75	5/8	2	.92	25	7.1
2870612C		1/2	1/2	3/4-16	1.82	7/8	2	.92	25	9.0
2870812C	SS	1/2	1/2	3/4-16	1.93	7/8	2	1.02	25 *	10.7
2870814C		5/8	5/8	7/8-14	1.99	1	2	1.02	25	12.8
2871014C		5/8	5/8	7/8-14	2.47	1	3	1.50	25	17.4
2871214C		3/4	5/8	7/8-14	2.47	1	3	1.50	25	24

- Añade 'BC' al final de número de parte para la opción de tapa de latón.
- * Para Acero Inoxidable, quitar la terminación 'C' y añadir 'SS'

Serie 288

HEMBRA GIRATORIA 37° JIC

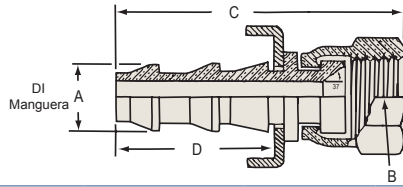

Número de Parte	303 SS	DI Manguera A	DE Tubo	Rosca UNF B	Longitud C	Hex	Barbas	Longitud de Barba D	Cant. por Caja	Lbs. por 100 pzs.
2880409C		1/4	3/8	9/16-18	1.60	11/16	2	.77	50	5.3
2880509C		5/16	3/8	9/16-18	1.60	11/16	2	.82	50	5.8
2880609C	SS	3/8	3/8	9/16-18	1.75	11/16	2	.92	50 *	6.5
2880809C		1/2	3/8	9/16-18	1.85	11/16	2	1.02	25	9.4
2881217C	SS	3/4	3/4	1 - 1/16-12 **	2.53	1-1/4	3	1.50	10 *	25.9
2881621C	SS	1	1	1 - 5/16-12 **	2.67	1-7/16	3	1.50	10 *	32.5

• Añade 'BC' al final de número de parte para la opción de tapa de latón. No disponible para DI de 5/16".

* Para Acero Inoxidable, quitar la terminación 'C' y añadir 'SS'

** Rosca UN

Serie 289

CODO 90° HEMBRA GIRATORIA 37° JIC / 45° SAE - ACERO

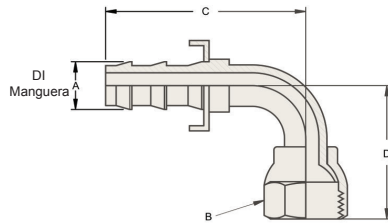

Número de Parte	DI Manguera A	DE Tubo	Rosca UNF B	Longitud de Línea Central C	Longitud de Línea Central D	Barbas	Cant. por Caja	Lbs. por 100 pzs.
2890407C +	1/4	1/4	7/16-20	1.55	.83	2	25	5.6
2890407CSAE *		1/4	7/16-20	1.60	.83	2	25	6.4
2890609C +	3/8	3/8	9/16-18	1.85	.91	2	25	10.0
2890610CSAE *		3/8	5/8-18	1.98	.85	2	25	11.2
2890812C +	1/2	1/2	3/4-16	2.33	1.09	2	10	18.1
2891217C +	3/4	3/4	1 - 1/16-12 **	3.26	1.81	3	5	40.0

* Muesca en tuerca para identificación SAE.

** Rosca UN

+ JIC solamente, puede substituir ángulo dual.

Serie 290

MACHO GIRATORIO UNF-SAE Abocinado Invertido

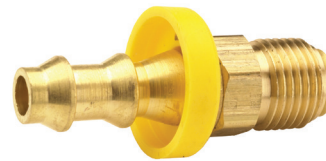
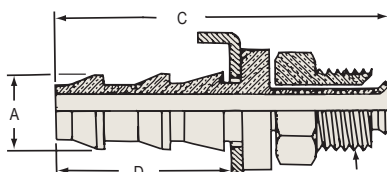

Número de Parte	DI Manguera A	DE Tubo	Rosca UNF B	Longitud C	Hex	Barbas	Longitud de Barba D	Cant. por Caja	Lbs. por 100 pzs.
2900406C		3/16	3/8-24	1.52	7/16	2	.77	100	3.2
2900407C	1/4	1/4	7/16-24 *	1.52	7/16	2	.77	100	3.1
2900408C		5/16	1/2-20	1.58	1/2	2	.77	100	3.8
2900508C	5/16	5/16	1/2-20	1.58	1/2	2	.77	50	4.1
2900510C		3/8	5/8-18	1.63	5/8	2	.77	50	6.1
2900608C	3/8	5/16	1/2-20	1.73	1/2	2	.92	100	5.8
2900610C		3/8	5/8-18	1.78	5/8	2	.92	50	7.0
2900812C	1/2	1/2	3/4-18 *	1.96	3/4	2	1.02	50	10.5
2901014C	5/8	5/8	7/8-18 *	2.50	7/8	3	1.50	25	14.9

* Rosca UNS

• Añade 'BC' al final de número de parte para la opción de tapa de latón. No disponible para DI de 5/16".

Serie 292

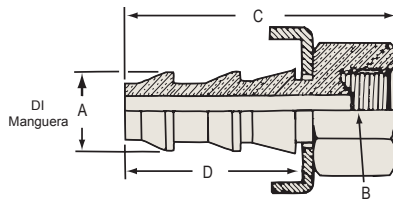

HEMBRA RÍGIDA

Rosca UNF-SAE Abocinado Invertido

Número de Parte	DI Manguera A	DE Tubo	Rosca UNF B	Longitud C	Hex	Barbas	Longitud de Barba D	Cant. por Caja	Lbs. por 100 pzs.
2920406C		3/16	3/8-24	1.17	7/16	2	.77	100	2.3
2920407C	1/4	1/4	7/16-24 *	1.16	1/2	2	.77	100	2.1
2920408C		5/16	1/2-20	1.19	9/16	2	.77	100	2.7
2920508C	5/16	5/16	1/2-20	1.19	9/16	2	.77	100	3.9
2920608C	3/8	5/16	1/2-20	1.34	9/16	2	.92	100	4.4
2920610C	3/8	3/8	5/8-18	1.39	3/4	2	.92	50	5.4
2920812C	1/2	1/2	3/4-18 *	1.54	7/8	2	1.02	25	7.8

* Rosca UNS

• Añade 'BC' al final de número de parte para la opción de tapa de latón.

Serie 294

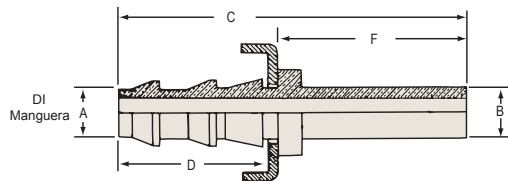

VÁSTAGO DE TUBING RÍGIDO

Número de Parte	303 SS	DI Manguera A	DE Tubo B	Longitud C	Longitud de Tubo F	Barbas	Longitud de Barba D	Cant. por Caja	Lbs. por 100 pzs.
2940403C			3/16	1.68	.86	2	.77	100	1.9
2940404C	SS	1/4	1/4	1.88	1.06	2	.77	100 *	1.8
2940405C			5/16	1.88	1.06	2	.77	100	2.6
2940606C	SS	3/8	3/8	2.03	1.06	2	.92	50 *	3.5
2940808C	SS	1/2	1/2	2.13	1.06	2	1.02	50 *	5.9
2941010C		5/8	5/8	2.61	1.06	3	1.50	25	9.7
2941212C	SS	3/4	3/4	2.61	1.06	3	1.50	25 *	25.3

* Para Acero Inoxidable, quitar la terminación 'C' y añadir 'SS'

• Añade 'BC' al final de número de parte para la opción de tapa de latón.

Serie 296

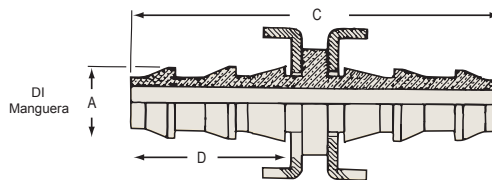

UNIÓN DE MANGUERA

Número de Parte	303 SS	DI Manguera A	Longitud C	Barbas	Longitud de Barba D	Cant. por Caja	Lbs. por 100 pzs.
2960404C	SS	1/4	1.73	2	.77	100 *	2.5
2960505C		5/16	1.73	2	.77	100	3.4
2960606C	SS	3/8	2.05	2	.92	50 *	7.5
2960808C	SS	1/2	2.25	2	1.02	50 *	7.5
2961010C		5/8	3.21	3	1.50	20	12.4
2961212C		3/4	3.21	3	1.50	15	15.4
2961616C		1	3.21	3	1.50	10	28.7

• Añade 'BC' al final de número de parte para la opción de tapa de latón. No disponible para DI de 5/16".

* Para Acero Inoxidable, quitar la terminación 'C' y añadir 'SS'

Conexiones para Tubería de Latón

Serie 163

TAPÓN DE CABEZA HEXAGONAL

La cabeza hexagonal es hueca

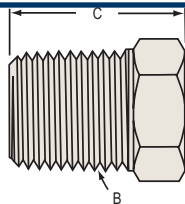

Número de Parte	Rosca NPT B	Longitud C	Hex	Cant. por Caja	Lbs. por 100 pzs.
1630200C	1/8-27	.56	7/16	50	1.7
1630400C	1/4-18	.63	9/16	100	3.4
1630600C	3/8-18	.78	11/16	25	5.1
1630800C	1/2-14	.97	7/8	25	8.0
1631200C	3/4-14	1.06	1-1/16	25	14.1
1631600C	1 - 11-1/2	1.35	1-3/8	10	28.0

Serie 165

NIPLE CORTO CON ROSCA

NPT

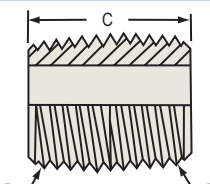

Número de Parte	Rosca NPT B	Longitud C	Diámetro de Flujo	Cant. por Caja	Lbs. por 100 pzs.
1650202C	1/8-27	.75	.250	50	1.0
1650404C	1/4-18	.88	.375	50	2.0
1650606C	3/8-18	1.00	.500	100	3.4
1650808C	1/2-14	1.12	.625	25	5.5
1651212C	3/4-14	1.31	.750	25	11.3
1651616C	1 - 11-1/2	1.75	.935	25	15.6

Serie 166

NIPLE LARGO CON ROSCA

NPT

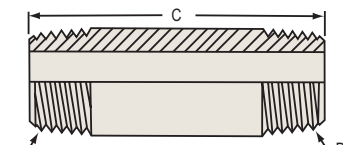

Número de Parte	Rosca NPT B	Longitud C	Diámetro de Flujo	Cant. por Caja	Lbs. por 100 pzs.
1660215C	1/8-27	1.50	.256	25	2.6
1660220C		2.00	.250	25	3.8
1660225C		2.50	.250	25	4.9
1660230C		3.00	.256	25	6.8
1660235C		3.50	.256	10	6.9
1660240C		4.00	.256	10	7.7
1660415C		1/4-18	1.50	.375	25
1660420C	2.00		.375	25	5.9
1660425C	2.50		.375	25	8.4
1660430C	3.00		.375	25	10.1
1660435C	3.50		.375	10	11.9
1660440C	4.00		.375	10	13.7
1660450C	5.00		.375	5	17.6
1660615C	3/8-18		1.50	.500	25
1660620C		2.00	.500	25	8.7
1660625C		2.50	.500	10	11.7
1660630C		3.00	.500	10	14.0
1660635C		3.50	.500	10	16.6
1660640C		4.00	.500	5	19.2

• Los últimos dos dígitos del número de serie representan la longitud.

Serie 166

NIPLE LARGO CON ROSCA

NPT (continuación)

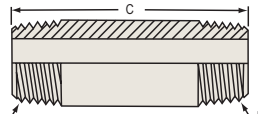

Número de Parte	Rosca NPT B	Longitud C	Diámetro de Flujo	Cant. por Caja	Lbs. por 100 pzs.
1660815C	1/2-14	1.50	.625	10	9.4
1660820C		2.00	.625	10	12.7
1660825C		2.50	.625	10	16.3
1660830C		3.00	.625	10	20.2
1660835C		3.50	.625	10	23.8
1660840C		4.00	.625	5	27.6
1661220C	3/4-14	2.00	.840	5	17.9
1661225C		2.50	.840	5	23.1
1661230C		3.00	.840	5	28.0
1661235C		3.50	.840	5	32.9

• Los últimos dos dígitos del número de serie representan la longitud.

Serie 169

CODO 90° ROSCA MACHO

NPTF - Dryseal

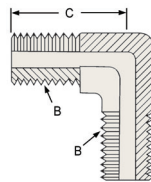

Número de Parte	Rosca NPTF B	Longitud de Línea Central C	Cant. por Caja	Lbs. por 100 pzs.
1690202C	1/8-27	.70	25	3.7
1690404C	1/4-18	.83	25	6.6
1690606C	3/8-18	.94	25	8.7
1690808C	1/2-14	1.10	25	16.5

Serie 172

UNIÓN MACHO

NPSM a NPTF

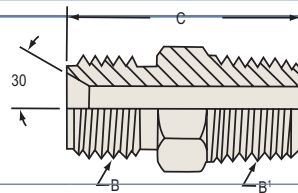

Número de Parte	Rosca NPSM B	Rosca NPTF B'	Longitud C	Hex	Cant. por Caja	Lbs. por 100 pzs.
1720202C	1/8	1/8-27	.94	7/16	100	2.5
1720402C	1/4	1/8-27	1.06	9/16	100	3.9
1720404C		1/4-18	1.25	9/16	100	5.1
1720604C	3/8	1/4-18	1.28	11/16	100	6.5
1720606C		3/8-18	1.30	11/16	50	8.1
1720608C		1/2-14	1.47	7/8	50	13.0
1720806C	1/2	3/8-18	1.35	7/8	50	10.5
1720808C		1/2-14	1.53	7/8	50	13.1
1721212C	3/4	3/4-14	1.53	1-1/16	25	18.8

Serie 174

ADAPTADOR

NPSM a NPTF

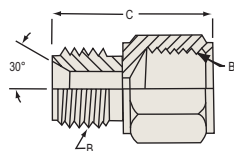

Número de Parte	Rosca NPSM B	Rosca NPTF B'	Longitud C	Hex	Cant. por Caja	Lbs. por 100 pzs.
1740404C	1/4	1/4	1.12	5/8	100	5.6
1740606C	3/8	3/8	1.15	3/4	50	6.9
1740808C	1/2	1/2	1.22	15/16	50	10.6

Serie 176

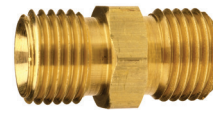
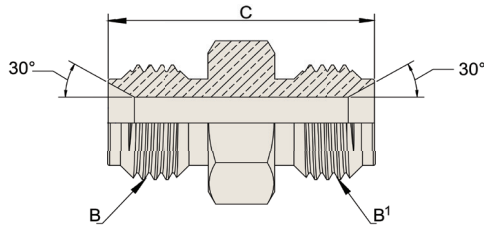

UNIÓN MACHO
NPSM a NPSM

Número de Parte	Rosca NPSM B	Rosca NPSM B'	Longitud C	Hex	Cant. por Caja.	Lbs. por 100 pzs.
1760202C	1/8	1/8	.79	7/16	100	2.0
1760404C	1/4	1/4	1.09	9/16	100	4.2
1760606C	3/8	3/8	1.19	11/16	100	7.2
1760808C	1/2	1/2	1.31	7/8	50	10.4

Serie 207BH

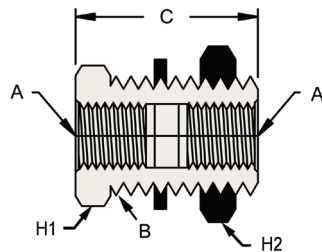

ACOPLE DE PARED

La arandela de tuerca es Acero 12L14

Número de Parte	Rosca Tubería NPTF A	Rosca Recta UNS B	Hex H1	Hex H2	Longitud C	Cant. por Caja.	Lbs. por 100 pzs.
207BH2	1/8-27	5/8-18	7/8	15/16	1.50	25	16.3
207BH4	1/4-18	3/4-16	1	1	1.50	25	19.4
207BH4S		3/4-16	1	1	.94	25	15.0
207BH6	3/8-18	1-14	1-1/8	1-1/4	1.31	10	27.5
207BH8	1/2-14	1-1/8-14	1-1/4	1-3/8	1.50	10	33.1
207BH12	3/4-14	1-5/16-12	1-1/2	1-1/2	1.50	10	41.3

Serie 211

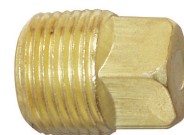
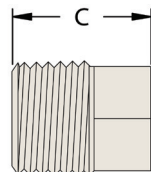

TAPÓN DE CABEZA CUADRADA

PTF-SAE Corto- Libre de Plomo para NSF/ANSI 372

Número de Parte	Rosca PTF-SAE B	Longitud C	Escuadra	Cant. por Caja.	Lbs. por 100 pzs.
2110200C	1/8-27	.59	9/32	50	2.0
2110400C	1/4-18	.80	3/8	100	3.0
2110600C	3/8-18	.83	7/16	25	6.0
2110800C	1/2-14	1.07	9/16	25	13.0
2111200C	3/4-14	1.14	5/8	25	20.0

TAPÓN DE TUBO
NPT

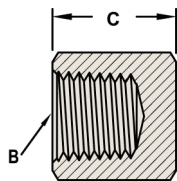

Número de Parte	Rosca NPT B	Longitud C	Hex	Cant. por Caja.	Lbs. por 100 pzs.
2130200C	1/8-27	.50	9/16	50	3.0
2130400C ¹	1/4-18	.63	5/8	100	4.0
2130600C ¹	3/8-18	.63	13/16	25	6.0
2130800C ¹	1/2-14	.87	1	25	8.0
2131200C	3/4-14	.89	1-3/16	25	16.0

¹ Libre de Plomo para NSF/ANSI 372

Serie 219

TAPÓN HEXAGONAL

NPTF - Libre de Plomo para NSF/ANSI 372

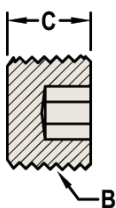

Número de Parte	Rosca NPTF B	Longitud C	Hex	Cant. por Caja.	Lbs. por 100 pzs.
2190200C	1/8-27	.30	3/16	50	1.0
2190400C	1/4-18	.46	1/4	100	2.0
2190600C	3/8-18	.46	5/16	25	3.0
2190800C	1/2-14	.61	3/8	25	5.0
2191200C	3/4-14	.62	9/16	25	10.0

Serie 228

CRUCETA HEMBRA DE ROSCA TUBO

NPTF - Dryseal

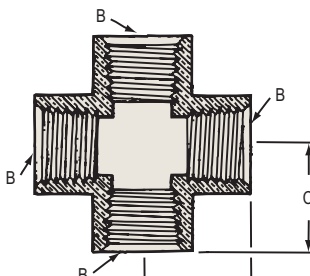

Número de Parte	Rosca NPTF B	Longitud C	Cant. por Caja.	Lbs. por 100 pzs.
2280202C	1/8-27	.57	25	9.6
2280404C	1/4-18	.78	25	19.5
2280606C	3/8-18	.84	25	26.7
2280808C	1/2-14	1.07	10	54.2
2281212C	3/4-14	1.16	10	72.1

Serie 302

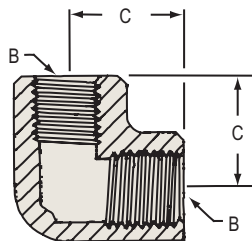

CODO 90° HEMBRA

NPTF - Dryseal
Ref. SAE 130238

Número de Parte	Rosca NPTF B	Longitud C	Cant. por Caja	Lbs. por 100 pzs.
3020202C	1/8-27	.55	25	6.3
3020404C	1/4-18	.78	25	14.8
3020606C	3/8-18	.84	25	20.0
3020808C	1/2-14	1.09	25	38.6
3021212C	3/4-14	1.16	10	58.1

Serie 304

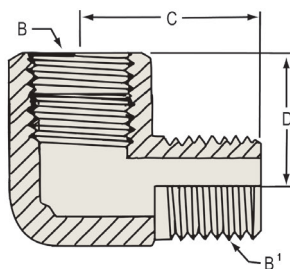

CODO 90° MACHO X HEMBRA

NPTF - Dryseal
Ref. SAE 130239

Número de Parte	Rosca NPTF B	Rosca NPTF B'	Longitud C	Longitud D	Cant. por Caja	Lbs. por 100 pzs.
3040202C	1/8-27	1/8-27	.66	.48	25	4.9
3040402C	1/4-18	1/8-27	.72	.45	25	11.3
3040404C	1/4-18	1/4-18	.91	.72	25	12.0
3040604C	3/8-18	1/4-18	1.25	.78	25	14.4
3040606C	3/8-18	3/8-18	.97	.78	25	16.4
3040806C	1/2-14	3/8-18	1.25	.97	25	32.3
3040808C	1/2-14	1/2-14	1.24	1.09	25	37.3
3041208C	3/4-14	1/2-14	1.39	1.10	25	50.3
3041212C	3/4-14	3/4-14	1.38	1.12	10	51.9

Serie 306

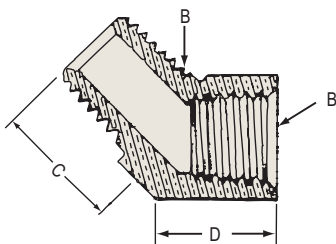

CODO 45° MACHO X HEMBRA

NPTF - Dryseal
Ref. SAE 130339

Número de Parte	Rosca NPTF B	Longitud C	Longitud D	Cant. por Caja	Lbs. por 100 pzs.
3060202C	1/8-27	.50	.38	25	3.7
3060404C	1/4-18	.72	.56	25	7.6
3060606C	3/8-18	.72	.56	25	11.9
3060808C	1/2-14	1.00	.75	25	25.8
3061212C	3/4-14	1.06	.75	10	34.1

TE HEMBRA
NPTF - Dryseal
Ref. SAE 130438

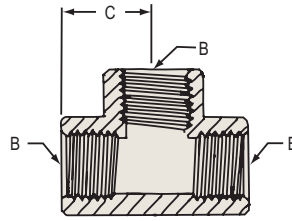

Número de Parte	Rosca NPTF B	Longitud C	Cant. por Caja	Lbs. por 100 pzs.
3220202C	1/8-27	.55	25	7.7
3220404C	1/4-18	.78	25	19.1
3220606C	3/8-18	.84	25	23.2
3220808C	1/2-14	1.09	25	47.1
3221212C	3/4-14	1.16	10	65.3

TE DE RAMIFICACIÓN MACHO
NPTF - Dryseal
Ref. SAE 130425

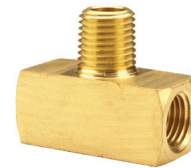
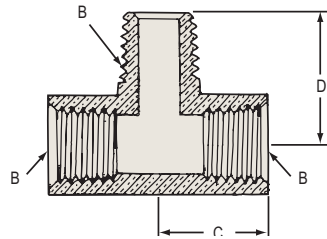

Número de Parte	Rosca NPTF B	Longitud C	Longitud D	Cant. por Caja.	Lbs. por 100 pzs.
3240202C	1/8-27	.55	.66	25	6.4
3240404C	1/4-18	.78	.91	25	16.1
3240606C	3/8-18	.84	.97	25	22.3
3240808C	1/2-14	1.09	1.25	25	42.4
3241212C	3/4-14	1.09	1.25	10	58.0

TE CODO MACHO Y HEMBRA
NPTF - Dryseal
Ref. SAE 130424

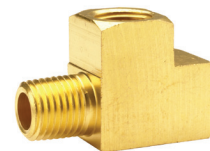
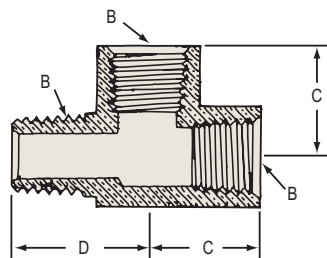

Número de Parte	Rosca NPTF B	Longitud C	Longitud D	Cant. por Caja	Lbs. por 100 pzs.
3260202C	1/8-27	.55	.73	25	6.3
3260404C	1/4-18	.78	.91	25	15.8
3260606C	3/8-18	.84	.97	25	21.6
3260808C	1/2-14	1.09	1.28	25	44.3
3261212C	3/4-14	1.09	1.38	10	59.1

Serie 370

NIPLE MACHO CON HEXÁGONO

NPTF - Dryseal
Ref. SAE 130137

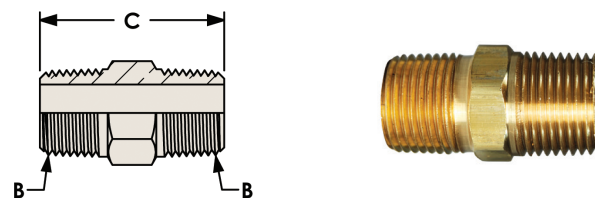

Número de Parte	Rosca NPTF B	Longitud C	Hex	Cant. por Caja	Lbs. por 100 pzs.
3700202C	1/8-27	.97	7/16	100	2.5
3700404C	1/4-18	1.38	9/16	100	5.4
3700606C	3/8-18	1.41	11/16	50	7.7
3700808C	1/2-14	1.81	7/8	25	14.4
3701212C	3/4-14	1.75	1-1/16	20	21.4
3701616C	1 - 11-1/2	2.24	1-3/8	10	40.0

Serie 371

ACOPLE HEMBRA CON HEXÁGONO

NPTF - Dryseal
Ref. SAE 130138



Número de Parte	Rosca NPTF B	Longitud C	Hex	Cant. por Caja	Lbs. por 100 pzs.
3710202C	1/8-27	.75	9/16	25	3.3
3710404C	1/4-18	1.12	3/4	25	8.8
3710606C	3/8-18	1.12	7/8	25	10.4
3710808C	1/2-14	1.50	1-1/16	25	19.9
3711212C	3/4-14	1.57	1-3/8	10	37.2

Serie 373

REDUCTOR BUSHING CON HEXÁGONO

NPTF - Dryseal
Ref. SAE 130140



Número de Parte	Rosca NPTF B Externa	Rosca NPTF B' Interna	Longitud C	Hex	Cant. por Caja	Lbs. por 100 pzs.
3730402C	1/4-18	1/8-27	.75	9/16	100	2.6
3730602C	3/8-18	1/8-27	.75	11/16	100	5.3
3730604C		1/4-18	.75	3/4	100	4.0
3730802C	1/2-14	1/8-27	1.00	7/8	25	12.9
3730804C		1/4-18	1.00	7/8	50	10.4
3730806C		3/8-18	1.00	7/8	50	7.3
3731202C *	3/4-14	1/8-27	.94	1-1/16	25	21.6
3731204C		1/4-18	1.00	1-1/8	25	20.5
3731206C		3/8-18	1.00	1-1/8	25	22.1
3731208C		1/2-14	1.00	1-1/8	25	12.5
3731604C *	1-11-1/2	1/4-18	1.12	1-3/8	10	48.7
3731606C *		3/8-18	1.12	1-7/16	10	43.7
3731608C		1/2-14	1.12	1-7/16	10	37.2
3731612C		3/4-14	1.12	1-7/16	10	27.0

* SAE no brinda una medida estandar para estas piezas.

ADAPTADOR
NPTF - Dryseal
Ref. SAE 130139

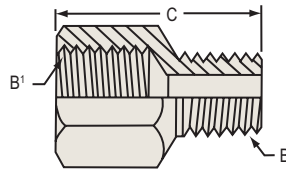

Número de Parte	Rosca NPTF B' Interna	Rosca NPTF B Externa	Longitud C	Hex	Cant. por Caja	Lbs. por 100 pzs.
3750202C	1/8-27	1/8-27	.88	9/16	100	3.6
3750402C	1/4-18	1/8-27	1.06	3/4	50	7.3
3750404C		1/4-18	1.25	3/4	50	8.8
3750602C	3/8-18	1/8-27	1.07	7/8	50	7.4
3750604C		1/4-18	1.25	7/8	50	10.2
3750606C		3/8-18	1.25	7/8	50	10.6
3750804C	1/2-14	1/4-18	1.47	1-1/16	25	9.8
3750806C		3/8-18	1.47	1-1/16	25	18.3
3750808C		1/2-14	1.66	1-1/16	25	20.6
3751206C		3/8-18	1.50	1-3/8	10	18.0
3751208C	3/4-14	1/2-14	1.69	1-3/8	10	33.2
3751212C		3/4-14	1.69	1-3/8	10	34.3

Serie 377

COPLE REDUCTOR
NPTF - Dryseal (hembra doble)
Ref. SAE 130138

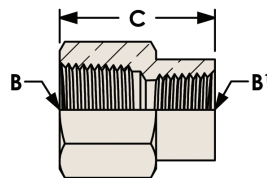

Número de Parte	Rosca NPTF B	Rosca NPTF B'	Longitud C	Hex	Cant. por Caja	Lbs. por 100 pzs.
3770402C	1/4-18	1/8-27	.97	3/4	50	7.5
3770602C	3/8-18	1/8-27	1.00	7/8	50	5.7
3770604C		1/4-18	1.16	7/8	50	11.6
3770804C	1/2-14	1/4-18	1.28	1-1/16	25	13.3
3770806C		3/8-18	1.38	1-1/16	10	20.1
3771206C	3/4-14	3/8-18	1.38	1-3/8	10	18.4
3771208C		1/2-14	1.50	1-3/8	10	23.1

Serie 379

NIPLE REDUCTOR CON HEXAGONO
NPTF - Dryseal
Ref. SAE 130137

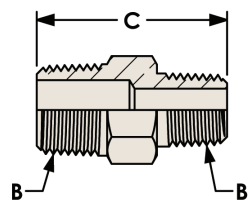

Número de Parte	Rosca NPTF B	Rosca NPTF B'	Longitud C	Hex	Cant. por Caja	Lbs. por 100 pzs.
3790402C	1/4-18	1/8-27	1.19	9/16	100	4.5
3790602C	3/8-18	1/8-27	1.22	11/16	50	6.3
3790604C		1/4-18	1.41	11/16	50	7.4
3790804C	1/2-14	1/4-18	1.62	7/8	50	10.5
3790806C		3/8-18	1.62	7/8	50	12.3
3791208C	3/4-14	1/2-14	1.80	1-1/16	25	18.9

Conexiones y Accesorios para Mangueras de Jardín

Serie 500



ACCESORIOS

Número de Parte	Descripción
500BFP	preventor de contraflujo

Características:

- 125 PSI máximo
- Temperatura de trabajo 33°F - 140°F
- Empaque EPDM
- Componentes de Acero Inoxidable

BOQUILLAS

Número de Parte	Descripción
500AN4	4" boquilla ajustable
500AN7	6" boquilla ajustable
500SN2	2" boquilla barredora, latón maquinado
500SN6	6" boquilla barredora, latón maquinado

ACCESORIOS- (LATÓN FORJADO)

Número de Parte	Descripción
500GHV	Válvula de bola en latón forjado, 3/4 NH macho x hembra; 140°F - 100 PSI
500GHY	Válvula Y doble, entrada giratoria - con roscas Higbie para prevenir roscas cruzadas; 140°F - 100 PSI
500YC	Cople Y, latón niquelado; 195°F - 150 PSI
500GH4VBK	GH 4 manifold de 4 válvulas, entrada giratoria, llave mariposa negra; 120°F - 100 PSI

ACOPLES

Número de Parte	303 SS	Descripción
500QCF	SS	Cople hembra; 140°F - 150 PSI
500QCSG		Empaque para cople: material NBR, 140°F - 150 PSI
500QCFV		Cople con válvula, cierre de agua; 140°F - 150 PSI
500QCM	SS	Espiga macho, rosca extendida; 195°F - 150 PSI
500QCK	SS	Ensamble completo; 140°F - 150 PSI
500QCKV		Ensamble completo, con válvula; 140°F - 150 PSI

COMPONENTES

Número de Parte	Descripción
5911212F	Empaque filtro, D.E. 1.00" , Malla de acero inoxidable 304, FDA PVC negro, durometro 70A
5911212W	Arandela, DI .63" , D.E.1.00" SBR negro durometro 80
5911616W	Arandela, DI .86" , D.E. 1.27" SBR negro durómetro 60
5861012N	3/4" Rosca redonda para manguera
5911212N	3/4" Rosca hexagonal para manguera
5911616N	1" Rosca hexagonal (NPSH) para manguera

Nota: Componentes de vástagos disponibles por separado. Contacte a Dixon para disponibilidad y precio.

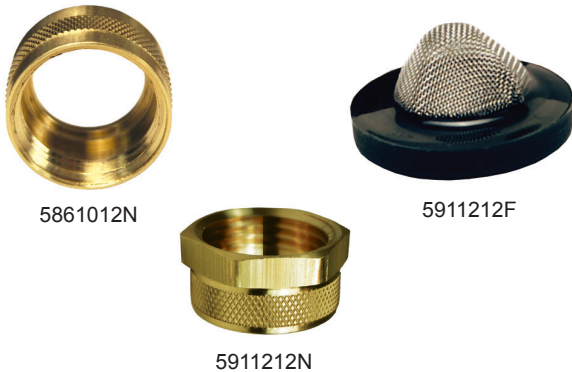
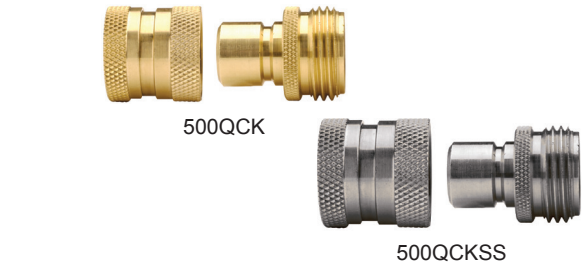
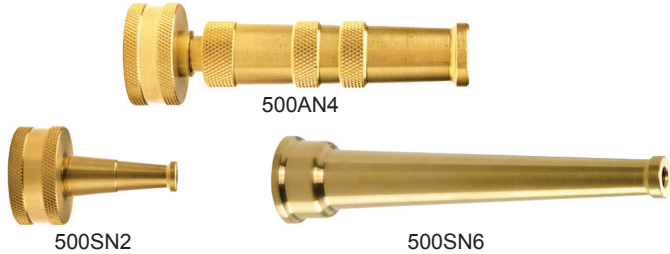



Acero Inoxidable 303

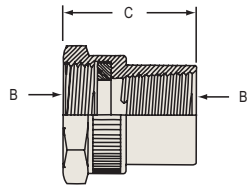

Latón CDA 360

Serie 501

HEMBRA GHT RÍGIDA X HEMBRA NPTF

NH no giratoria x NPTF

Número de Parte	303 SS	Rosca NH B	Rosca NPTF B'	Longitud C	Hex	Cant. por Caja	Lbs. por 100 pzs.
5011202C			1/8-27	1.02	1-3/16	50	9.9
5011204C			1/4-18	1.12	1-3/16	25	10.4
5011206C		3/4 - 11-1/2	3/8-18	1.18	1-3/16	25	10.6
5011208C	SS		1/2-14	1.32	1-3/16	25 *	12.4
5011212C	SS		3/4-14	1.56	1-3/16	25 *	13.0

* Para Acero Inoxidable, quitar la terminación 'C' y añadir 'SS'



Acero Inoxidable 303

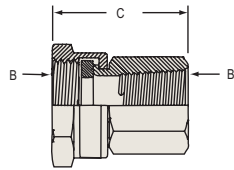

Latón CDA 360

Serie 502

HEMBRA GHT X HEMBRA NPTF

NH giratoria x NPTF

Número de Parte	303 SS	Rosca NH B	Rosca NPTF B'	Longitud C	Hex	Cant. por Caja	Lbs. por 100 pzs.
5021208C	SS	3/4 - 11-1/2	1/2-14	1.33	1-3/16	25 *	15.4
5021212C	SS		3/4-14	1.59	1-3/16	10 *	22.3

* Para Acero Inoxidable, quitar la terminación 'C' y añadir 'SS'. Las roscas 502-SS B' son NPT



Acero Inoxidable 303

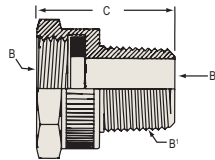

Latón CDA 360

Serie 503

HEMBRA GHT X MACHO NPTF

NH no giratoria x NPTF

Número de Parte	303 SS	Rosca NH B	Rosca NPTF B'	Rosca NPTF B''	Longitud C	Hex	Cant. por Caja	Lbs. por 100 pzs.
5031206C			3/8-18	---	1.37	1-3/16	25	11.3
5031208C	SS	3/4 - 11-1/2	1/2-14	---	1.37	1-3/16	25 *	13.0
5031212C	SS		3/4-14	1/2-14	1.37	1-3/16	25 *	14.0

* Para Acero Inoxidable, quitar la terminación 'C' y añadir 'SS'. Las roscas 503-SS B' son NPT.



Acero Inoxidable 303

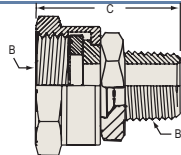

Latón CDA 360

Serie 504

HEMBRA GHT GIRATORIA X MACHO NPTF

Giratoria - NH hexagonal Interno y Externo x NPTF

Número de Parte	303 SS	Rosca NH B	Rosca NPTF B'	Longitud C	Hex	Cant. por Caja	Lbs. por 100 pzs.
5041204C			1/4-18	1.43	1-3/16	25	12.5
5041206C		3/4 - 11-1/2	3/8-18	1.43	1-3/16	25	15.1
5041208C	SS		1/2-14	1.63	1-3/16	25 *	16.3
5041212C	SS		3/4-14	1.43	1-3/16	20 *	19.4

* Para Acero Inoxidable, quitar la terminación 'C' y añadir 'SS'. Las roscas 504-SS B' son NPT.

Serie 506

HEMBRA GHT x HEMBRA GHT

Giratoria NH x NH

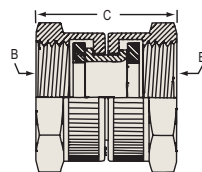

Número de Parte	Rosca NH B	Longitud C	Hex	Cant. por Caja	Lbs. por 100 pzs.
5061212C	3/4 - 11-1/2	1.32	1-3/16	25	14.1

Serie 507

MACHO GHT x HEMBRA NPTF

NH x NPTF

Acero Inoxidable 303

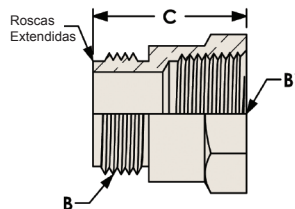

Latón CDA 360

Número de Parte	303 SS	Rosca NH B	Rosca NPTF B'	Longitud C	Hex	Cant. por Caja	Lbs. por 100 pzs.
5071204C		3/4 - 11-1/2	1/4-18	.75	1-1/16	25	13.6
5071206C			3/8-18	.75	1-1/16	25	11.1
5071208C	SS		1/2-14	.75	1-1/16	25 *	7.9
5071212C	SS		3/4-14	1.37	1-3/16	25 *	20.0

* Para Acero Inoxidable, quitar la terminación 'C' y añadir 'SS'. Las roscas 507-SS B' son NPT.

Serie 508

MACHO GHT x MACHO NPTF

NH x NPTF

Acero Inoxidable 303

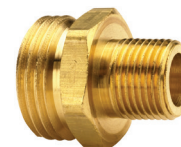
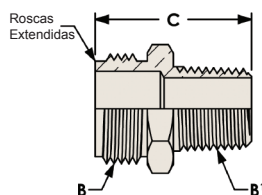

Latón CDA 360

Número de Parte	303 SS	Rosca NH B	Rosca NPTF B'	Longitud C	Hex	Cant. por Caja	Lbs. por 100 pzs.
5081206C		3/4 - 11-1/2	3/8-18	1.31	1-1/16	25	11.9
5081208C	SS		1/2-14	1.50	1-1/16	25 *	13.5
5081212C	SS		3/4-14	1.50	1-1/16	25 *	16.7
5081216C			1 - 11-1/2	1.85	1-3/8	10	22.5

* Para Acero Inoxidable, quitar la terminación 'C' y añadir 'SS'. Las roscas 508-SS B' son NPT.

Serie 509

MACHO GHT x MACHO GHT

NH x NH

Acero Inoxidable 303

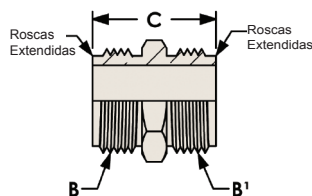

Latón CDA 360

Número de Parte	303 SS	Rosca NH B	Rosca NH B'	Longitud C	Hex	Cant. por Caja	Lbs. por 100 pzs.
5091212C	SS	3/4 - 11-1/2	3/4 - 11-1/2	1.24	1-1/16	25 *	13.1
5091612C		1 - 11-1/2 **	3/4 - 11-1/2	1.43	1-3/8	20	18.9

* Para Acero Inoxidable, quitar la terminación 'C' y añadir 'SS'

** Rosca NPSH

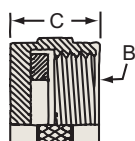

TAPÓN PARA MANGUERA DE JARDÍN

Redondo

Número de Parte	Rosca NH B	Longitud C	Cant. por Caja	Lbs. por 100 pzs.
5131212C	3/4 - 11-1/2	.625	25	7.8

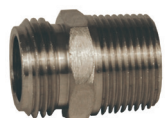

Acero Inoxidable 303

**MACHO GHT x MACHO NPTF
x HEMBRA NPTF
NH x NPTF x NPTF**

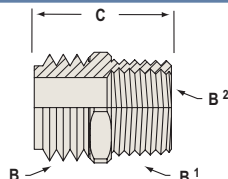

Latón CDA 360

Número de Parte	303 SS	Rosca NH B	Rosca NPTF B ¹	Rosca NPTF B ²	Longitud C	Hex	Cant. por Caja	Lbs. por 100 pzs.
5141212C	SS	3/4 - 11-1/2	3/4-14	1/2-14	1.50	1-1/16	25*	16

* Para Acero Inoxidable, quitar la terminación 'C' y añadir 'SS'. Las roscas 514-SS son NPT.

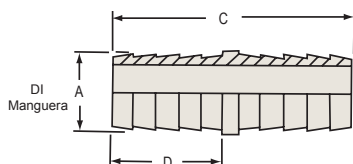

UNIÓN DE MANGUERA

Número de Parte	DI Manguera A	Longitud C	Barbas	Longitud de Barba D	Cant. por Caja	Lbs. por 100 pzs.
5780808C	1/2	2.06	4	.97	50	6.5
5781010C	5/8	2.06	4	.97	50	8.6
5781212C	3/4	2.50	4	1.19	20	12.9
5781616C	1	3.00	5	1.44	10	22.5

Nota: Ve la página 8 para uniones de Acero Inoxidable

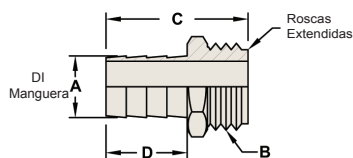

**VÁSTAGO CORTO
MACHO GHT**

Número de Parte	DI Manguera A	Rosca NH B	Longitud C	Hex	Barbas	Longitud de Barba D	Cant. por Caja	Lbs. por 100 pzs.
5850812C	1/2	3/4 - 11-1/2	1.75	1-1/16	3	1.00	25	11.0
5851012C	5/8	3/4 - 11-1/2	1.75	1-1/16	3	1.00	25	11.9
5851212C	3/4	3/4 - 11-1/2	1.75	1-1/16	3	1.00	25	13.4

Serie 586

VÁSTAGO CORTO HEMBRA GIRATORIA (Tuerca Redonda)

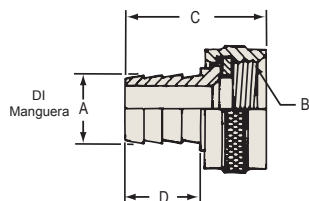

Número de Parte	DI Manguera A	Rosca NH B	Longitud C	Barbas	Longitud de Barbas D	Cant. por Caja	Lbs. por 100 pzs.
5860812C	1/2	3/4 - 11-1/2	1.63	3	1.00	25	9.8
5861012C	5/8	3/4 - 11-1/2	1.63	3	1.00	25	10.2
5861212C	3/4	3/4 - 11-1/2	1.63	3	1.00	25	11.5

Serie 587

VÁSTAGO CORTO SET DE CONEXIONES PARA MANGUERA* (Tuerca Redonda)

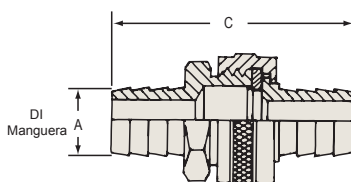

Número de Parte	DI Manguera A	Rosca NH B	Longitud C	Barbas	Cant. por Caja	Lbs. por 100 pzs.
5870808K	1/2	3/4 - 11-1/2	2.95	3	25	20.8
5871010K	5/8	3/4 - 11-1/2	2.95	3	25	22.1
5871212K	3/4	3/4 - 11-1/2	2.95	3	25	25.0

* no ensamblada

Serie 588

VÁSTAGO CORTO HEMBRA GIRATORIA (Tuerca Hexagonal)

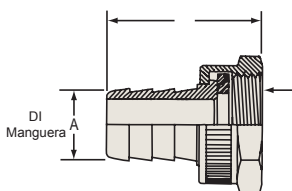

Número de Parte	DI Manguera A	Rosca NH B	Longitud C	Barbas	Longitud de Barbas D	Cant. por Caja	Lbs. por 100 pzs.
5880812C	1/2	3/4 - 11-1/2	1.63	3	1.00	25	10.7
5881012C	5/8	3/4 - 11-1/2	1.63	3	1.00	25	10.9
5881212C	3/4	3/4 - 11-1/2	1.63	3	1.00	25	12.1

Serie 589

VÁSTAGO CORTO SET DE CONEXIONES PARA MANGUERA* (Tuerca Hexagonal)

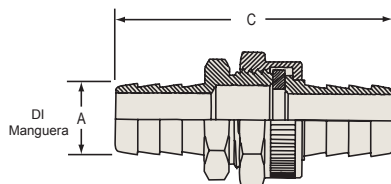

Número de Parte	DI Manguera A (ambas conexiones)	Rosca NH B	Longitud C	Barbas	Cant. por Caja	Lbs. por 100 pzs.
5890808K	1/2	3/4 - 11-1/2	2.95	3	25	21.7
5891010K	5/8	3/4 - 11-1/2	2.95	3	25	22.9
5891212K	3/4	3/4 - 11-1/2	2.95	3	25	25.6

* no ensamblada

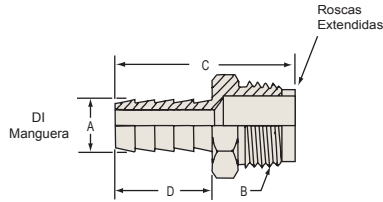

MACHO MAQUINADO

Número de Parte	303 SS	DI Manguera A	Rosca NH B	Longitud C	Hex	Barbas	Longitud de Barbas D	Cant. por Caja	Lbs. por 100 pzs.
5900612C		3/8	3/4 - 11-1/2	1.94	1-1/16	4	1.19	25	11.3
5900812C	SS	1/2	3/4 - 11-1/2	1.94	1-1/16	4	1.19	25 *	12.3
5901012C	SS	5/8	3/4 - 11-1/2	1.94	1-1/16	4	1.19	25 *	14.5
5901212C	SS	3/4	3/4 - 11-1/2	1.94	1-1/16	4	1.19	25 *	15.1
5901612C		1	3/4 - 11-1/2	1.94	1-1/16	4	1.19	10	21.4
5901616C		1	1 - 11-1/2 **	2.38	1-3/8	5	1.44	10	25.6

* Para Acero Inoxidable, quitar la terminación 'C' y añadir 'SS'

** Rosca NPSH - extendida

Serie 591

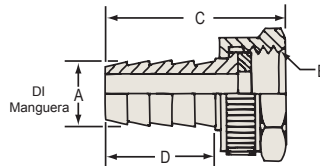

HEMBRA CON ROSCA GIRATORIA MAQUINADA

Número de Parte	303 SS	DI Manguera A	Rosca NH B	Longitud C	Hex	Barbas	Longitud de Barbas D	Cant. por Caja	Lbs. por 100 pzs.
5910612C		3/8	3/4 - 11-1/2	1.82	1-3/16	4	1.19	25	11.2
5910812C	SS	1/2	3/4 - 11-1/2	1.82	1-3/16	4	1.19	25 *	11.5
5911012C	SS	5/8	3/4 - 11-1/2	1.82	1-3/16	4	1.19	25 *	12.2
5911212C	SS	3/4	3/4 - 11-1/2	1.82	1-3/16	4	1.19	25 *	13.5
5911612C		1	3/4 - 11-1/2	2.10	1-3/16	4	1.19	10	25.2
5911616C		1	1 - 11-1/2 **	2.25	1-7/16	5	1.44	10	24.4

* Para Acero Inoxidable, quitar la terminación 'C' y añadir 'SS'

** Rosca NPSH

Serie 592

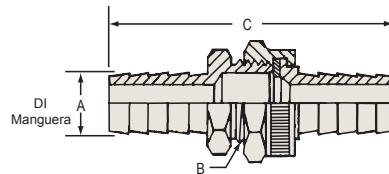

ACOPLE COMPLETO MAQUINADO - no ensamblado

Número de Parte	303 SS	DI Manguera (ambas conexiones) A	Rosca NH B	Longitud C	Barbas	Cant. por Caja	Lbs. por 100 pzs.
5920606K		3/8	3/4 - 11-1/2	3.32	4	25	22.5
5920808K	SS	1/2	3/4 - 11-1/2	3.32	4	25 *	23.8
5921010K	SS	5/8	3/4 - 11-1/2	3.32	4	25 *	26.7
5921212K	SS	3/4	3/4 - 11-1/2	3.32	4	25 *	28.6
5921612K		1	3/4 - 11-1/2	3.60	4	10	46.7
5921616K		1	1 - 11-1/2 **	4.19	5	10	50.0

* Para Acero Inoxidable, quitar la terminación 'K' y añadir 'SS'

** Rosca NPSH

Serie 593

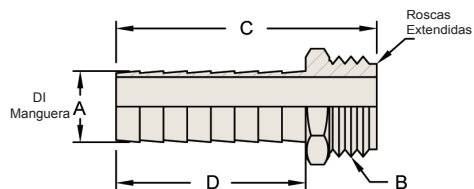

MACHO GHT VÁSTAGO LARGO

Número de Parte	DI Manguera A	Rosca NH B	Longitud C	Hex	Barbas	Longitud de Barbas D	Cant. por Caja	Lbs. por 100 pzs.
5930812C	1/2	3/4 - 11-1/2	2.78	1-1/16	7	2.03	25	13.8
5931012C	5/8	3/4 - 11-1/2	2.78	1-1/16	7	2.03	25	15.1
5931212C	3/4	3/4 - 11-1/2	2.78	1-1/16	7	2.03	10	17.9
5931616C	1	1 - 11-1/2 *	2.96	1- 3/8	7	2.03	5	28.9

* Rosca NPSH

Serie 594

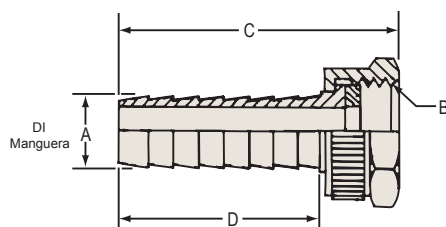

HEMBRA GHT GIRATORIA VÁSTAGO LARGO

Número de Parte	DI Manguera A	Rosca NH B	Longitud C	Hex	Barbas	Longitud de Barbas D	Cant. por Caja	Lbs. por 100 pzs.
5940812C	1/2	3/4 - 11-1/2	2.66	1-3/16	7	2.03	25	13.0
5941012C	5/8	3/4 - 11-1/2	2.66	1-3/16	7	2.03	25	14.2
5941212C	3/4	3/4 - 11-1/2	2.66	1-3/16	7	2.03	10	16.7
5941616C	1	1 - 11-1/2 *	2.84	1-7/16	7	2.03	5	28.8

* Rosca NPSH

Serie 595

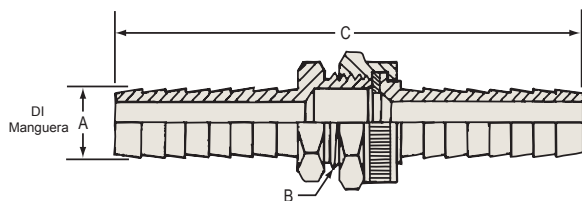

ACOPLE COMPLETO SET GHT **

Número de Parte	DI Manguera A (ambas conexiones)	Rosca NH B	Longitud C	Barbas	Cant. por Caja	Lbs. por 100 pzs.
5950808K	1/2	3/4 - 11-1/2	5.05	7	25	26.9
5951010K	5/8	3/4 - 11-1/2	5.05	7	25	29.3
5951212K	3/4	3/4 - 11-1/2	5.05	7	10	34.6
5951616K	1	1 - 11-1/2 *	5.20	7	5	57.6

* Rosca NPSH

** No ensamblado

Características:

- La válvula de rocío brinda la humedad apropiada en los extremos de rollos de papel.
- Ayuda a eliminar dobleces y problemas de descarga, incrementando la producción y reduciendo desperdicios.
- Una ligera flexión de la manguera en cualquier dirección (360°) activa el spray.
- Acción rápida sin manijas, depresores de pulgar, gatillos u otros dispositivos.
- El sellado positivo de agua se active cuando la manguera regresa a su posición y causa que la válvula interna cierre, inmediatamente deteniendo el rocío.
- Mecanismo de sellado sin empaques.

Series 833



válvula con gancho

Hembra NPT	Descripción	# de Parte
1/4"	válvula, sin gancho	83304
3/8"	válvula, sin gancho	83306
1/4"	válvula, con gancho	83304H
3/8"	válvula, con gancho	83306H

Series 832



Ensamble para Manguera de Válvula de Rocío

Número de Parte	Entrada Macho NPT	Descripción
8320605	3/8"	DI 3/8", 5' Manguera
8320606	3/8"	DI 3/8", 6' Manguera
8320608	3/8"	DI 3/8", 8' Manguera
8320610	3/8"	DI 3/8", 10' Manguera
8320612	3/8"	DI 3/8", 12' Manguera
8320615	3/8"	DI 3/8", 15' Manguera
8320605H	3/8"	DI 3/8", 5' Manguera con gancho
8320606H	3/8"	DI 3/8", 6' Manguera con gancho
8320608H	3/8"	DI 3/8", 8' Manguera con gancho
8320610H	3/8"	DI 3/8", 10' Manguera con gancho
8320612H	3/8"	DI 3/8", 12' Manguera con gancho
8320615H	3/8"	DI 3/8", 15' Manguera con gancho

Ensamble de Manguera para Engrasadora

Serie GWH



Características:

- Acoples crimpados de una sola pieza
- Rosca macho NPT 1/8-27, base sólida
- Manguera 3/16" de DI que excede norma SAE 100R1-AT
- Para usarse con pistolas de grasa de mano solamente.
- Disponible con resorte de alivio y empaque para venta de estante

ENSAMBLES DE MANGUERA

Número de Parte	Longitud del ensamble	Resorte de Alivio	Empaque para venta de retail	Cant. por Caja
GWH0800	8"	Añade 'S' al número de parte		Depende del cliente
GWH1200	12"	Añade 'S' al número de parte	Añade 'R' al número de parte	
GWH1800	18"	Añade 'S' al número de parte	Añade 'R' al número de parte	
GWH2400	24"	Añade 'S' al número de parte		
GWH3600	36"	Añade 'S' al número de parte		
GWH4800	48"	Añade 'S' al número de parte		
GWH6000	60"	Añade 'S' al número de parte		

Para longitudes no listadas, llama a Dixon para cotizar (50 mínimo)

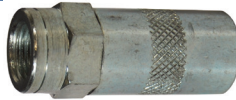

ACOPLES Y CONEXIONES

Número de Parte	Descripción	Material	Empaque para venta de detalle	Cant. por Caja
GWHC	Acople para manguera de grasa	Acero Zincado	Añade 'R' al # de parte	10
GWHC-FF	Acople de flujo completo para manguera de grasa	Acero Zincado	Añade 'R' al # de parte	10
0010055C	Rosca macho NPT 1/8-27, base perforada y biselada	Latón		100
0010260C	Rosca macho NPT 1/8-27, base sólida	Latón		100
0010860C	Rosca hembra NPT 1/8-27	Latón		100



GWHZ000
GWHZ400

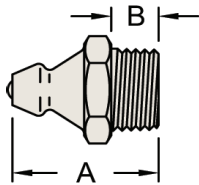

GWHZ045
GWHZ445

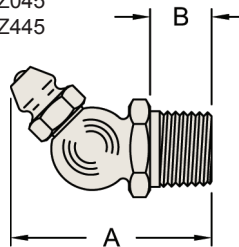

GWHZ090
GWHZ490

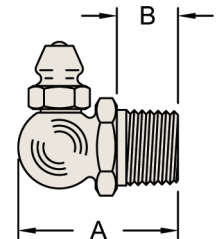

CONEXIONES GHWZ- ZERK (para engrasadora) Acero Zincado

Número de Parte	Descripción	Rosca	A Longitud Total	B Longitud de Rosca	Hex	Cant. por Caja	Lbs. por 100 pzs.
GWHZ000	Bola check	1/8-27 NPT	.66	.26	.43	100	1.00
GWHZ045	Bola check ángulo 45°	1/8-27 NPT	.86	.28	.43	100	1.00
GWHZ090	Bola check ángulo 90°	1/8-27 NPT	.83	.31	.43	100	1.00
GWHZ400	Bola check	1/4-28 cónico SAE-LT	.53	.20	.312	100	1.00
GWHZ445	Bola check ángulo 45°	1/4-28 cónico SAE-LT	.80	.20	.375	100	1.00
GWHZ490	Bola check ángulo 90°	1/4-28 cónico SAE-LT	1.20	.20	.375	100	1.00

Todos los ítems disponibles en paquetes de venta retail: ordene 1 para 1 paquete retail de 10 piezas.

Conexiones de Compresión

Serie 60

MANGA 60C
Referencia SAE 060115

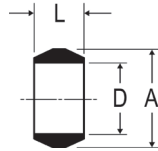

Número de Parte	Medida Tubo	A	D	L	Cant. por Caja
60C-02	1/8	.187	.130	.19	100
60C-03	3/16	.266	.192	.22	100
60C-04	1/4	.344	.255	.25	100
60C-05	5/16	.406	.318	.25	100
60C-06	3/8	.469	.382	.25	100
60C-07	7/16	.531	.444	.31	100
60C-08	1/2	.594	.507	.38	100
60C-10	5/8	.719	.632	.38	100
60C-12	3/4	.875	.758	.44	50
60C-14	7/8	1.000	.883	.41	50

MANGA DE ACETAL 60PT

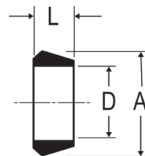

Número de Parte	Pared de plástico	Pared de Tubo	A	D	L	Cant. por Caja
60PT-04	1/4	.40	.375	.254	.19	200
60PT-05	5/16	.62	.438	.317	.19	100
60PT-06	3/8	.62	.500	.379	.19	100
60PT-08	1/2	.62	.631	.507	.25	100
60PT-10	5/8	.62	.747	.632	.22	100

TUERCA 61C
Referencia SAE 060110

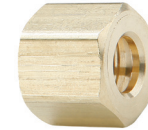
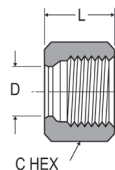

Número de Parte	Tamaño de Tubo	Cabeza recta	Hex C	D	L	Cant. por Caja
61C-02	1/8	5/16-24	3/8	.130	.38	100
61C-03	3/16	3/8-24	7/16	.192	.41	100
61C-04	1/4	7/16-24	1/2	.255	.44	100
61C-05	5/16	1/2-24	9/16	.318	.44	50
61C-06	3/8	9/16-24	5/8	.382	.47	100
61C-07	7/16	5/8-24	11/16	.444	.50	25
61C-08	1/2	11/16-20	13/16	.507	.62	50
61C-10	5/8	13/16-18	15/16	.632	.62	25
61C-12	3/4	1-18	1-3/16	.758	.69	25
61C-14	7/8	1-1/8-18	1-1/4	.890	.62	25

TUERCA LARGA 61CL
Referencia SAE 060111

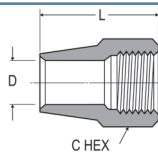

Número de Parte	Tamaño de Tubo	Cabeza recta	Hex C	D	L	Cant. por Caja
61CL-04	1/4	7/16-24	1/2	.255	.75	10
61CL-05	5/16	1/2-24	9/16	.318	.84	10
61CL-06	3/8	9/16-24	5/8	.382	.97	10
61CL-08	1/2	11/16-20	13/16	.507	1.06	10
61CL-10	5/8	13/16-18	15/16	.632	1.19	10
61CL-12	3/4	1-18	1-3/16	.758	1.38	10

Serie 62C

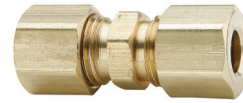
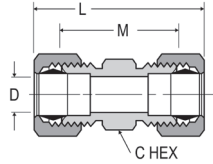

UNIÓN 62C

Referencia SAE 060101 BA

Número de Parte	Tamaño de Tubing	Rosca recta	Hex C	L	M	Diámetro de Flujo	Cant. por Caja
62C-02	1/8	5/16-24	5/16	1.05	.64	.094	25
62C-03	3/16	3/8-24	3/8	1.21	.72	.125	25
62C-04	1/4	7/16-24	7/16	1.33	.79	.188	50
62C-05	5/16	1/2-24	1/2	1.39	.85	.250	50
62C-06	3/8	9/16-24	9/16	1.52	.97	.312	50
62C-07	7/16	5/8-24	5/8	1.70	1.02	.312	10
62C-08	1/2	11/16-20	11/16	1.90	1.08	.406	25
62C-10	5/8	13/16-18	13/16	2.06	1.23	.500	10
62C-12	3/4	1-18	1	2.37	1.41	.562	10
62C-14	7/8	1-1/8-18	1-1/8	2.07	1.19	.766	10

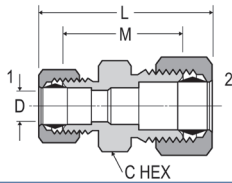

UNIÓN REDUCTOR 62C

Referencia SAE 060101 BA

Número de Parte	1 Tamaño de Tubing	2 Tamaño de Tubo	1 Rosca Recta	2 Rosca Recta	Hex C	L	M	Diámetro de Flujo	Cant. por Caja
62C-0403	3/16	1/4	3/8-24	7/16-24	7/16	1.29	.78	.125	10
62C-0604	1/4	3/8	7/16-24	9/16-24	9/16	1.46	.97	.188	10
62C-0806	3/8	1/2	9/16-24	11/16-20	11/16	1.71	1.03	.312	10
62C-1006	3/8	5/8	9/16-24	13/16-18	13/16	1.82	1.13	.312	10

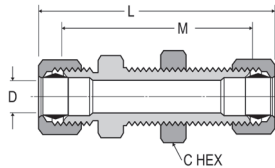

UNIÓN DE PARED 62CBH

Número de Parte	Tamaño de Tubing	Rosca Recta	Hex C	L	M	Diámetro de Flujo	Cant. por Caja
62CBH-04	1/4	7/16-24	9/16	2.29	1.75	.188	10
62CBH-06	3/8	9/16-24	11/16	2.42	1.88	.312	10

Serie 63

INSERTOS 63PT

para tubing de plástico grado industrial

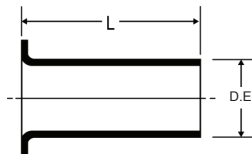

Número de Parte	DE Tubo	Grosor de Pared	L	DE	Cant. por Caja
63PT-0216	1/8	.016	.46	.080	100
63PT-0223		.023	.45	.073	200
63PT-0325		.025	.45	.135	100
63PT-0340	3/16	.040	.52	.095	100
63PT-0440		.040	.50	.163	200
63PT-0462	1/4	.062	.33	.110	50
63PT-0540		.040	.50	.232	100
63PT-0562	5/16	.062	.53	.187	100
63PT-0662		.062	.56	.250	200
63PT-0862	1/2	.062	.72	.370	100
63PT-1062	5/8	.062	.72	.483	100

Los balines Delrin e insertos de latón convierten las conexiones de compresión en conexiones útiles para tubing de termoplástico.

Serie 66C

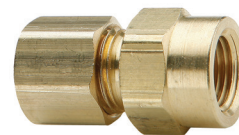
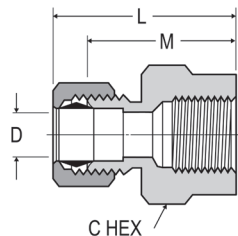

CONECTOR HEMBRA 66C
Referencia SAE 060103 BA

Número de Parte	Tamaño de Tubo	Rosca NPTF	Rosca UNF	Hex C	L	M	Diámetro de Flujo	Cant. por Caja
66C-0202	1/8	1/8	5/16-24	9/16	.95	.75	.094	10
66C-0302	3/16	1/8	3/8-24	9/16	1.02	.78	.125	25
66C-0304		1/4	3/8-24	11/16	1.20	.96	.125	10
66C-0402	1/4	1/8	7/16-24	9/16	1.02	.78	.188	25
66C-0404		1/4	7/16-24	11/16	1.24	1.00	.188	10
66C-0502	5/16	1/8	1/2-24	9/16	1.07	.81	.250	10
66C-0504		1/4	1/2-24	11/16	1.29	1.03	.250	10
66C-0602	3/8	1/8	9/16-24	9/16	1.06	.78	.312	10
66C-0604		1/4	9/16-24	11/16	1.34	1.06	.312	10
66C-0606		3/8	9/16-24	13/16	1.34	1.06	.312	10
66C-0608		1/2	9/16-24	1	1.54	1.27	.312	10
66C-0804	1/2	1/4	11/16-20	11/16	1.49	1.09	.406	10
66C-0806		3/8	11/16-20	13/16	1.52	1.12	.406	10
66C-0808		1/2	11/16-20	1	1.71	1.31	.406	10
66C-1008		5/8	1/2	13/16-18	1	1.80	1.38	.500

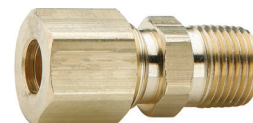
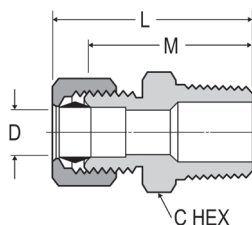

Serie 68C

CONECTOR MACHO 68C
Referencia SAE 060102 BA

Número de Parte	Tamaño de Tubo	Tamaño de Tubing	Rosca Recta	Hex C	L	M	Diámetro de Flujo	Cant. por Caja
68C-0202	1/8	1/8	5/16-24	7/16	.97	.77	.094	25
68C-0302	3/16	1/8	3/8-24	7/16	1.08	.84	.125	50
68C-0304		1/4	3/8-24	9/16	1.27	1.03	.125	25
68C-0402	1/4	1/8	7/16-24	7/16	1.10	.86	.188	50
68C-0404		1/4	7/16-24	9/16	1.30	1.06	.188	50
68C-0406		3/8	7/16-24	11/16	1.27	1.03	.188	10
68C-0408		1/2	7/16-24	7/8	1.55	1.31	.188	10
68C-0502	5/16	1/8	1/2-24	1/2	1.15	.89	.234	25
68C-0504		1/4	1/2-24	9/16	1.33	1.07	.250	50
68C-0602	3/8	1/8	9/16-24	9/16	1.25	.97	.250	25
68C-0604		1/4	9/16-24	9/16	1.42	1.14	.312	25
68C-0606		3/8	9/16-24	11/16	1.44	1.16	.312	25
68C-0608		1/2	9/16-24	7/8	1.53	1.25	.312	25
68C-0704	7/16	1/4	5/8-24	5/8	1.50	1.17	.312	10
68C-0804	1/2	1/4	11/16-20	11/16	1.62	1.22	.312	10
68C-0806		3/8	11/16-20	11/16	1.60	1.20	.406	25
68C-0808		1/2	11/16-20	7/8	1.71	1.31	.406	25
68C-1006	5/8	3/8	13/16-18	13/16	1.73	1.31	.406	10
68C-1008		1/2	13/16-18	7/8	1.90	1.48	.500	10
68C-1012		3/4	13/16-18	1-1/16	1.98	1.56	.500	10
68C-1208	3/4	1/2	1-18	1	2.05	1.60	.562	10
68C-1212		3/4	1-18	1-1/16	2.08	1.63	.656	10
68C-1412		7/8	3/4	1-1/8-18	1-1/8	1.76	1.41	.750

Serie 164C y 264C

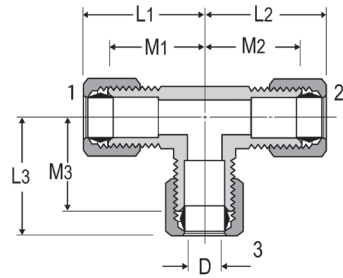

164C

TÉ UNIÓN 164C-264C

Referencia SAE 060401 BA

Número de Parte	Tamaño Tubo 1 y 2	Tubo 3	Rosca Recta	L1	L2	L3	M1	M2	M3	Diámetro de Flujo	Cant. por Caja
164C-02	1/8	1/8	5/16-24	.82	.82	.82	.61	.61	.61	.094	10
264C-03	3/16	3/16	3/8-24	.84	.84	.84	.60	.60	.60	.125	10
164C-04	1/4	1/4	7/16-24	.86	.86	.86	.61	.61	.61	.188	25
164C-05	5/16	5/16	1/2-24	.98	.98	.98	.71	.71	.71	.250	10
164C-06	3/8	3/8	9/16-24	1.03	1.03	1.03	.74	.74	.74	.312	25
164C-08	1/2	1/2	11/16-20	1.34	1.34	1.34	.93	.93	.93	.406	10
164C-10	5/8	5/8	13/16-18	1.54	1.54	1.54	1.08	1.08	1.08	.500	10
164C-06-06-04	3/8	1/4	---	1.03	1.03	.96	.75	.75	.72	.188	25
164C-08-08-06	1/2	3/8	---	1.34	1.34	1.16	.94	.94	.88	.312	10

Serie 165C

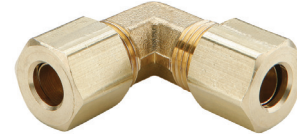
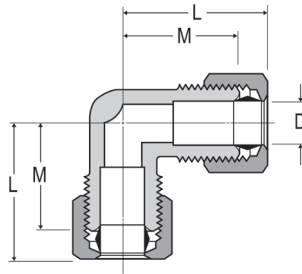

CODO DE UNIÓN 165C

Referencia SAE 060201 BA

Número de Parte	Tamaño Tubo	Rosca Recta	L	M	Diámetro de Flujo	Cant. por Caja
165C-02	1/8	5/16-24	.82	.61	.094	10
165C-03	3/16	3/8-24	.87	.61	.125	10
165C-04	1/4	7/16-24	.88	.61	.188	10
165C-05	5/16	1/2-24	.95	.71	.250	10
165C-06	3/8	9/16-24	1.03	.74	.312	10
165C-07	7/16	5/8-24	1.16	.82	.312	5
165C-08	1/2	11/16-20	1.34	.93	.406	10
165C-10	5/8	13/16-18	1.48	1.05	.500	10
165C-12	3/4	1-18	1.65	1.17	.560	5

Serie 169C y 269C

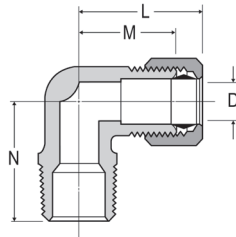

CODO MACHO 169C-269C
Referencia SAE 060202 BA

Número de Parte	Tamaño Tubo	Rosca de Tubing	Rosca Recta	L	M	N	Diámetro de Flujo D	Cant. por Caja
269C-0202	1/8	1/8	5/16-24	.80	.60	.67	.094	10
169C-0302	3/16	1/8	3/8-24	.84	.61	.69	.125	10
169C-0304		1/4	3/8-24	.86	.64	.93	.125	10
169C-0402	1/4	1/8	7/16-24	.86	.61	.74	.188	50
169C-0404		1/4	7/16-24	.86	.62	.94	.188	50
169C-0406		3/8	7/16-24	.93	.68	1.00	.188	10
169C-0502	5/16	1/8	1/2-24	.88	.61	.74	.234	10
169C-0504		1/4	1/2-24	.95	.71	.93	.250	25
169C-0506		3/8	1/2-24	1.01	.75	1.00	.250	10
169C-0602	3/8	1/8	9/16-24	1.03	.74	.74	.234	10
169C-0604		1/4	9/16-24	1.03	.74	.93	.312	25
169C-0606		3/8	9/16-24	1.03	.75	1.00	.312	25
169C-0608		1/2	9/16-24	1.22	.94	1.27	.312	10
169C-0804	1/2	1/4	11/16-20	1.34	.94	1.00	.312	10
169C-0806		3/8	11/16-20	1.34	.93	1.11	.406	10
169C-0808		1/2	11/16-20	1.48	1.06	1.15	.406	10
169C-1008		5/8	1/2	13/16-18	1.48	1.06	1.31	.500
169C-1208	3/4	1/2	1-18	1.64	1.18	1.49	.562	5
169C-1212		3/4	1-18	1.70	1.27	1.58	.562	5

Serie 170C

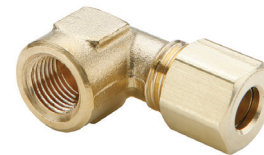
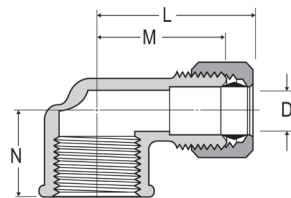

CODO HEMBRA 170C
Referencia SAE 060203 BA

Número de Parte	Tamaño Tubo	Rosca de Tubing	Rosca Recta	L	M	N	Diámetro de Flujo D	Cant. por Caja
170C-0202	1/8	1/8	5/16-24	.89	.69	.56	.094	10
170C-0302	3/16	1/8	3/8-24	.98	.73	.56	.125	25
170C-0402	1/4	1/8	7/16-24	.93	.69	.56	.188	25
170C-0404		1/4	7/16-24	1.02	.78	.70	.188	25
170C-0604	3/8	1/4	9/16-24	1.06	.79	.73	.312	10
170C-0606		3/8	9/16-24	1.22	.94	.69	.312	10
170C-0704	7/16	1/4	5/8-24	1.27	.93	.73	.312	5
170C-0806	1/2	3/8	11/16-20	1.34	1.00	.69	.406	10

Serie 171C

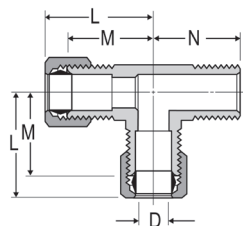

TE DE FLUJO MACHO 171C

Número de Parte	Tamaño Tubo	Rosca de Tubing	Rosca Recta	L	M	N	Diámetro de Flujo D	Cant. por Caja
171C-0202	1/8	1/8	5/16-24	.82	.61	.71	.094	10
171C-0302	3/16	1/8	3/8-24	.86	.61	.71	.125	10
171C-0402	1/4	1/8	7/16-24	.90	.64	.75	.188	10
171C-0404		1/4	7/16-24	.93	.69	.72	.188	10
171C-0604	3/8	1/4	9/16-24	1.09	.81	1.03	.312	10

Serie 172C

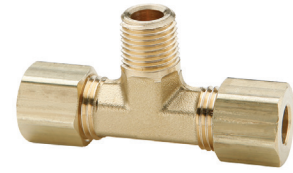
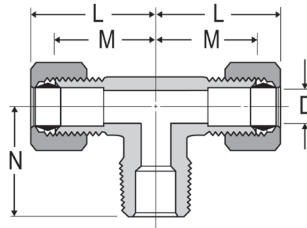

TE DE RAMIFICACIÓN MACHO 172C
Referencia SAE 060425 BA

Número de Parte	Tamaño Tubo	Rosca Tubería	Rosca Recta	L	M	N	Diámetro de Flujo D	Cant. por Caja
172C-0202	1/8	1/8	5/16-24	.82	.61	.71	.094	10
172C-0302	3/16	1/8	3/8-24	.86	.61	.71	.125	10
172C-0402	1/4	1/8	7/16-24	.86	.61	.74	.188	10
172C-0404		1/4	7/16-24	.93	.69	.92	.188	10
172C-0602	3/8	1/8	9/16-24	1.03	.75	.75	.234	10
172C-0604		1/4	9/16-24	1.09	.77	1.03	.312	10
172C-0606		3/8	9/16-24	1.09	.81	1.00	.312	10
172C-0806	1/2	3/8	11/16-20	1.34	.93	1.10	.406	10

Serie 176C

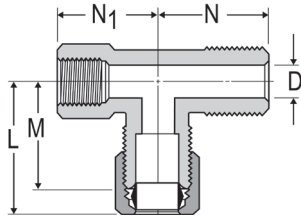

TE ADAPTADOR 176C

Número de Parte	Tamaño Tubo	Rosca Tubería	Rosca Recta	L	M	N	N1	Diámetro de Flujo D	Cant. por Caja
176C-0402	1/4	1/8	7/16-24	.93	.69	.75	.66	.189	10

Serie 177C

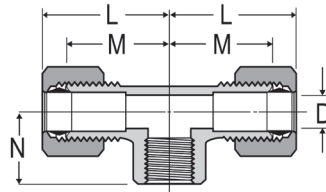

TE DE RAMIFICACIÓN HEMBRA 177C

Número de Parte	Tamaño Tubo	Rosca Tubería	Rosca Recta	L	M	N	Diámetro de Flujo D	Cant. por Caja
177C-0402	1/4	1/8	7/16-24	.86	.63	.53	.188	10

Serie 179C

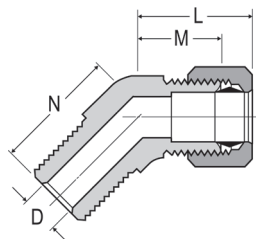

CODO 45° 179C

Número de Parte	Tamaño Tubo	Rosca Tubería	Rosca Recta	L	M	N	Diámetro de Flujo D	Cant. por Caja
179C-0402	1/4	1/8	7/16-24	.90	.66	.56	.188	10
179C-0404		1/4	7/16-24	.80	.56	.84	.188	10
179C-0602	3/8	1/8	9/16-24	.90	.63	.65	.234	10
179C-0604		1/4	9/16-24	.90	.63	.84	.312	10
179C-0606		3/8	9/16-24	.97	.75	.95	.312	10
179C-0806	1/2	3/8	11/16-20	1.15	.81	.95	.406	10

Serie 639C

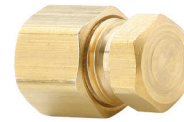
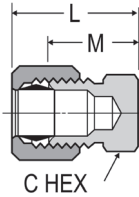

TAPÓN DE SELLADO 639C

Número de Parte	Tamaño Tubo	Rosca Recta	Hex C	L	M	Cant. por Caja
639C-04	1/4	7/16-24	7/16	.74	.50	25

Serie 682C

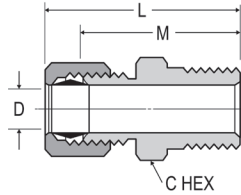

ACOPLE PARA TANQUE DE PASO DIRECTO 682C

Número de Parte	Tamaño Tubo	Rosca Tubería	Rosca Recta	Hex C	L	M	Diámetro de Flujo D	Cant. por Caja
682C-0302	3/16	1/8	3/8-24	7/16	1.06	.84	.195	10
682C-0606	3/8	3/8	9/16-24	11/16	1.44	1.16	.387	10
682C-0808	1/2	1/2	11/16-20	7/8	1.90	1.31	.516	10

Especificaciones:

Registro con UL para líquidos inflamables. Las conexiones de compresión cumplen con requerimientos funcionales de las normas SAE J-512 y ASA.

Aplicaciones:

Usarse con tubing de cobre, aluminio y tubing termoplástico, no se recomienda el tubing de acero, no se recomienda para aplicaciones que usen fluidos gaseosos.

Rangos de Presión de Trabajo:

La temperatura y el tipo de tubing son factores importantes y la tabla de la derecha es una guía para una selección propia. Temperatura 73°F, para rangos de presión del tubing de termoplástico vea recomendaciones del fabricante.

PSI	DE Tubo (pulgadas)	Grosor de Pared (pulgadas)
400	1/8	.030
400	3/16	.030
300	1/4	.030
300	5/16	.032
200	3/8	.032
200	1/2	.032
150	5/8	.035
100	3/4	.035
75	7/8	.035

Rangos de Temperatura:

De -65° a +250°F con tubing de metal suave. Para tubing de termoplástico vea las recomendaciones del fabricante.

Instrucciones de Ensamble:

1. Deslice la tuerca, después el barril en el tubing. La terminal roscada de la tuerca debe apuntar hacia afuera.
2. Inserte el tubing dentro de la conexión. Asegúrese que el tubing llegue hasta el fondo sobre el hombro de la conexión.
3. Ensamble la tuerca el número de vueltas de llave de tuercas que indica la tabla siguiente.

Tamaño Conexión	Tamaño del Tubo	Vueltas requeridas para sellar después de apretar a mano	
		Serie 60C con tubing de metal suave	Serie 60PT con tubing de termoplástico
2	1/8	1-1/4	--
3	3/16	1-1/4	--
4	1/4	1-1/4	2
5	5/16	1-1/4	2
6	3/8	2-1/4	2
8	1/2	2-1/4	2
10	5/8	2-1/4	2
12	3/4	2-1/4	2
14	7/8	2-1/4	--

Características:

- Máxima presión de trabajo: **150 PSI**
- Rango de Temperatura: **-40°F a + 200°F**



TUBING NEUMÁTICO

Referencia SAE J844, TIPO A y B, D.O.T. FMVSS 106

Número de Parte	Tamaño de Tubo	Color estándar	Cant. por Caja
J844-03-BL-100	3/16	negro	100'
J844-04-BL-100	1/4	negro	100'
J844-04-B-100	1/4	blue	100'
J844-04-R-100	1/4	rojo	100'
J844-06-BL-100	3/8	negro	100'
J844-06-B-100	3/8	azul	100'
J844-06-R-100	3/8	rojo	100'
J844-08-BL-100	1/2	negro	100'
J844-10-BL-100	5/8	negro	100'
J844-12-BL-100	3/4	negro	100'

CORTADORA DE TUBING

Número de Parte	Descripción
TC97	D.E. Máximo 9/16"
TC97RB	Cuchilla de reemplazo



CONEXIONES PARA FRENOS DE AIRE

Aplicaciones:

- Las conexiones para frenos de aire estilo compresión utilizan barriles para lograr la compresión y un agarre positivo.

Características:

- Materiales: maquinadas de latón CA360, CA345 ó CA377
- Sellador de Rosca pre-aplicado sobre las roscas tubo macho.
- Temperatura de Trabajo: **150 PSI** máxima
- Rango de Temperatura: **-40°F a 200°F (-40°C a 93°C)**
- Tubing compatible: SAE J844 tipo A y B
- Especificaciones: cumple con D.O.T FMVSS 571.106 y SAE J1131, y SAE J2494

Instrucciones de Ensamble:

1. Corte el tubing a escuadra - ángulo de 15° máximo permisible
2. Verifique que el puerto esté limpio y sin rebabas.
3. Inserte el tubing en la conexión hasta que asiente en el fondo.
4. Apriete la tuerca con una llave hasta que quede visible un hilo de la rosca en el cuerpo; (esto permitirá un número de re-hechuras) ó, la tuerca debe apretarse a mano, y entonces apretarla con llave como se indica en la tabla de abajo.

Tamaño de Tubo	Vueltas requeridas para sellar después de apretar a mano
3/16	2-1/2
1/4	3
3/8 y 1/2	4
5/8 y 3/4	3-1/2

BARRIL 60NAB

Referencia SAE 100115

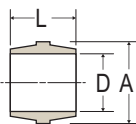

Número de Parte	Tamaño de Tubo	A	D	L	Cant. por Caja
60NAB3	3/16	.255	.194	.23	100
60NAB4	1/4	.356	.256	.30	100
60NAB6	3/8	.479	.384	.39	100
60NAB8	1/2	.624	.509	.43	100
60NAB10	5/8	.746	.634	.49	100
60NAB12	3/4	.922	.760	.54	50

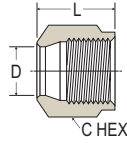

TUERCA 61NAB
Referencia SAE 100110

Número de Parte	Tamaño de Tubo	Rosca Recta	Hex C	D	L	Cant. por Caja
61NAB3	3/16	5/16-24	7/16	.194	.40	100
61NAB4	1/4	7/16-24	9/16	.256	.45	100
61NAB6	3/8	17/32-24	5/8	.384	.63	100
61NAB8	1/2	11/16-20	13/16	.509	.72	50
61NAB10	5/8	13/16-18	15/16	.634	.77	25
61NAB12	3/4	1-18	1-1/8	.762	.81	25

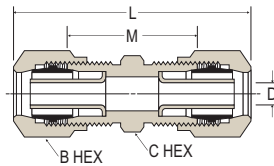

UNIÓN 62NAB
Referencia SAE 100101 BA

Número de Parte	Tamaño de Tubo	Rosca Recta	Hex B	Hex C	L	M	Flujo D	Cant. por Caja
62NAB4	1/4	7/16-24	9/16	7/16	1.49	.83	.137	10
62NAB6	3/8	17/32-24	5/8	9/16	2.00	1.08	.217	10
62NAB8	1/2	11/16-20	13/16	11/16	2.33	1.29	.338	10
62NAB10	5/8	13/16-18	15/16	13/16	2.39	1.41	.398	10
62NAB12	3/4	1-18	1-1/8	1	2.60	1.58	.523	10

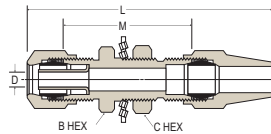

UNIÓN PASAMUROS 62NABH
(NAB y freno de aire)

Número de Parte	Tamaño de Tubo	Rosca Recta	Hex B	Hex C	L	M	Flujo D	Cant. por Caja
62NABH4	1/4	7/16-24	9/16	9/16	2.28	1.38	.137	10
62NABH6	3/8	17/32-24	11/16	3/4	2.97	1.62	.217	10
62NABH8	1/2	11/16-20	13/16	1	3.36	1.88	.338	10

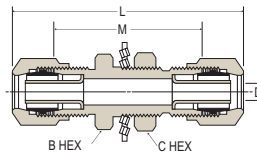

UNIÓN PARAMUROS 62NBH

Número de Parte	Tamaño de Tubo	Rosca Recta	Hex B	Hex C	L	M	Flujo D	Cant. por Caja
62NBH3	3/16	5/16-24	7/16	7/16	1.80	1.21	.087	10
62NBH4	1/4	7/16-24	9/16	9/16	2.04	1.38	.137	10
62NBH6	3/8	17/32-24	11/16	3/4	2.54	1.62	.21	10
62NBH8	1/2	11/16-20	13/16	1	2.92	1.88	.33	10
62NBH10	5/8	13/16-18	15/16	1	3.04	2.02	.398	10

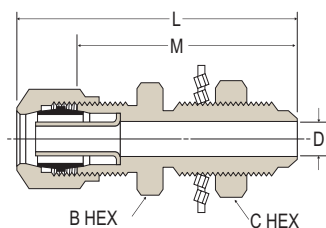

UNIÓN PASAMUROS 62NFBH

Número de Parte	Tamaño de Tubo	Rosca Recta	Hex B	Hex C	L	M	D	Cant. por Caja
62NFBH4	1/4	7/16-24	9/16	9/16	2.04	1.38	.137	10
62NFBH6	3/8	17/32-24	11/16	3/4	2.54	1.62	.217	10
62NFBH8	1/2	11/16-20	13/16	1	2.92	1.88	.338	10
62NFBH10	5/8	13/16-18	15/16	1	3.04	2.02	.398	10

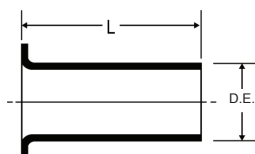

INSERTO DE ACERO INOXIDABLE 63NAB
(para tubing SAE J844)

Número de Parte	Tamaño de Tubo	L	DE	Cant. por Caja
63NAB4	1/4	.53	.163	200
63NAB6	3/8	.64	.245	200
63NAB8	1/2	.81	.370	100
63NAB10	5/8	.86	.434	100
63NAB12	3/4	1.04	.559	100

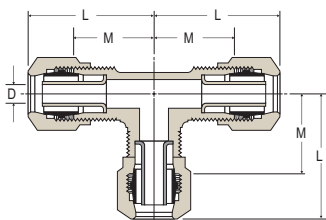

TE UNIÓN 64NAB
Referencia SAE 100401 BA

Número de Parte	Tamaño de Tubo	Rosca Recta	L	M	Flujo D	Cant. por Caja
64NAB4	1/4	7/16-24	.95	.62	.13	25
64NAB6	3/8	17/32-24	1.24	.78	.21	25
64NAB8	1/2	11/16-20	1.45	.93	.33	10
64NAB10	5/8	13/16-18	1.58	1.09	.39	10

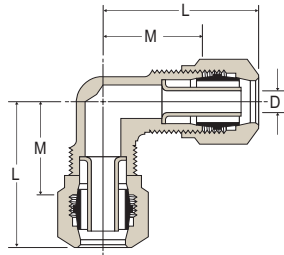

CODO UNIÓN 65NAB
Referencia SAE 100201 BA

Número de Parte	Tamaño de Tubo	Rosca Recta	L	M	Flujo D	Cant. por Caja
65NAB4	1/4	7/16-24	.95	.62	.13	10
65NAB6	3/8	17/32-24	1.25	.79	.21	10
65NAB8	1/2	11/16-20	1.45	.93	.33	10
65NAB10	5/8	13/16-18	1.58	1.09	.39	10

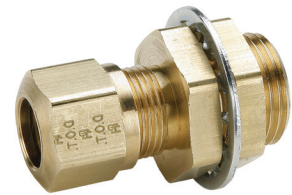
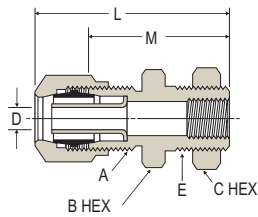

UNIÓN PASAMUROS 66NBH

Número de Parte	Tamaño de Tubo	Tamaño de Tubing	Rosca Recta A	Rosca Recta E	Hex B	Hex C	L	M	Flujo D	Cant. por Caja
66NBH86	1/2	3/8	11/16-20	7/8-14	1-1/16	1-1/16	1.94	1.42	.338	10

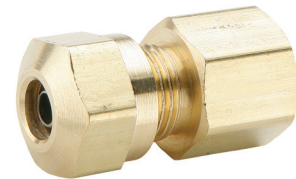
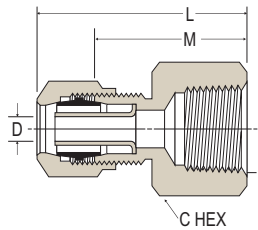

CONECTOR HEMBRA 66NAB
Referencia SAE 100103 BA

Número de Parte	Tamaño de Tubo	Rosca de Tubería	Rosca Recta	Hex C	L	M	Flujo D	Cant. por Caja
66NAB42	1/4	1/8	7/16-24	9/16	1.17	.84	.13	25
66NAB44		1/4	7/16-24	11/16	1.40	1.07	.13	10
66NAB62	3/8	1/8	17/32-24	9/16	1.46	1.00	.21	10
66NAB64		1/4	17/32-24	11/16	1.64	1.18	.21	10
66NAB86 *	1/2	3/8	11/16-20	7/8	1.79	1.27	.33	10
66NAB88		1/2	11/16-20	1-1/16	1.91	1.38	.33	10
66NAB106	5/8	3/8	13/16-18	7/8	1.87	1.38	.39	10
66NAB108		1/2	13/16-18	1-1/16	1.99	1.60	.39	10

* No con hexágono completo, como se muestra.

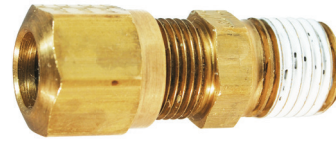
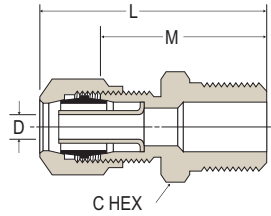

CONECTOR MACHO 68NAB

Referencia SAE 100102 BA

Sellador de roscas puede ser blanco o naranja quemado

Número de Parte	Tamaño de Tubo	Rosca de Tubería	Rosca Recta	Hex C	L	M	Flujo D	Cant. por Caja
68NAB31VS	3/16	1/16	5/16-24	3/8	1.16	.87	.087	25
68NAB32VS		1/8	5/16-24	7/16	1.15	.86	.087	50
68NAB34VS		1/4	5/16-24	9/16	1.35	1.05	.087	25
68NAB42VS	1/4	1/8	7/16-24	7/16	1.22	.89	.13	50
68NAB44VS		1/4	7/16-24	9/16	1.43	1.09	.13	50
68NAB46VS		3/8	7/16-24	11/16	1.47	1.14	.13	10
68NAB62VS	3/8	1/8	17/32-24	9/16	1.49	1.03	.21	25
68NAB64VS		1/4	17/32-24	9/16	1.67	1.21	.21	25
68NAB66VS		3/8	17/32-24	11/16	1.70	1.21	.21	25
68NAB68VS		1/2	17/32-24	7/8	1.89	1.43	.21	25
68NAB84VS	1/2	1/4	11/16-20	11/16	1.85	1.32	.33	10
68NAB86VS		3/8	11/16-20	11/16	1.85	1.32	.33	25
68NAB88VS		1/2	11/16-20	7/8	2.04	1.52	.33	25
68NAB106VS	5/8	3/8	13/16-18	13/16	1.86	1.37	.398	10
68NAB108VS		1/2	13/16-18	7/8	2.07	1.56	.398	10
68NAB126VS	3/4	3/8	1-18	1	2.00	1.49	.440	10
68NAB128VS		1/2	1-18	1	2.19	1.68	.523	10
68NAB1212VS		3/4	1-18	1-1/16	2.22	1.71	.523	10

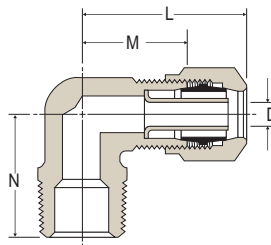

CODO MACHO 69NAB

Referencia SAE 100202 BA

Sellador de roscas puede ser blanco o naranja quemado

Número de Parte	Tamaño de Tubo	Rosca de Tubería	Rosca Recta	L	M	N	Flujo D	Cant. por Caja
69NAB32VS	3/16	1/8	5/16-24	.90	.60	.67	.087	10
69NAB34VS		1/4	5/16-24	.91	.62	.87	.087	10
69NAB42VS	1/4	1/8	7/16-24	.95	.62	.66	.13	50
69NAB44VS		1/4	7/16-24	1.00	.68	.87	.13	50
69NAB46VS		3/8	7/16-24	1.16	.73	.86	.13	10
69NAB62VS	3/8	1/8	17/32-24	1.19	.73	.75	.21	10
69NAB64VS		1/4	17/32-24	1.25	.79	.92	.21	25
69NAB66VS		3/8	17/32-24	1.30	.84	.91	.21	25
69NAB68VS		1/2	17/32-24	1.40	.94	1.10	.21	10
69NAB84VS	1/2	1/4	11/16-20	1.38	.86	.99	.33	10
69NAB86VS		3/8	11/16-20	1.44	.92	.99	.33	10
69NAB88VS		1/2	11/16-20	1.55	1.03	1.18	.33	10
69NAB106VS	5/8	3/8	13/16-18	1.49	1.00	1.05	.39	10
69NAB108VS		1/2	13/16-18	1.58	1.09	1.24	.39	5
69NAB128VS	3/4	1/2	1-18	1.70	1.19	1.33	.52	5
69NAB1212VS		3/4	1-18	1.77	1.26	1.32	.52	5

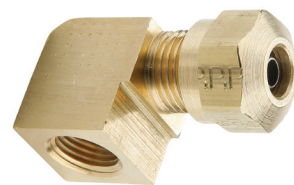
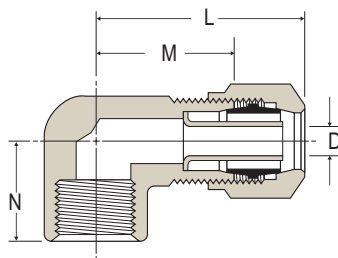

CODO HEMBRA 70NAB
Referencia SAE 100203 BA

Número de Parte	Tamaño de Tubo	Rosca de Tubería	Rosca Recta	L	M	N	Flujo D	Cant. por Caja
70NAB32	3/16	1/8	5/16-24	.96	.67	.52	.087	10
70NAB42	1/4	1/8	7/16-24	1.02	.69	.52	.13	10
70NAB44		1/4	7/16-24	1.11	.78	.71	.13	50
70NAB62	3/8	1/8	17/32-24	1.29	.83	.59	.21	50
70NAB64 *		1/4	17/32-24	1.25	.80	.58	.21	10
70NAB66		3/8	17/32-24	1.39	.93	.77	.21	10
70NAB86	1/2	3/8	11/16-20	1.55	1.03	.82	.33	25
70NAB88		1/2	11/16-20	1.65	1.13	1.01	.33	25
70NAB108	5/8	1/2	13/16-18	1.70	1.19	1.07	.39	10

* codo redondeado - no es como la imagen

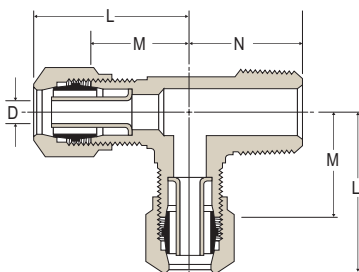

TE DE FLUJO MACHO 71NAB
Referencia SAE 100424 BA

Sellador de roscas puede ser blanco o naranja quemado

Número de Parte	Tamaño de Tubo	Rosca de Tubería	Rosca Recta	L	M	N	Flujo D	Cant. por Caja
71NAB42VS	1/4	1/8	7/16-24	.95	.62	.66	.13	10
71NAB44VS		1/4	7/16-24	1.00	.68	.87	.13	10
71NAB64VS	3/8	1/4	17/32-24	1.25	.79	.92	.21	10
71NAB66VS		3/8	17/32-24	1.30	.84	.91	.21	10
71NAB86VS	1/2	3/8	11/16-20	1.45	.93	.99	.33	10
71NAB88VS		1/2	11/16-20	1.55	1.03	1.18	.33	10
71NAB108VS	5/8	1/2	13/16-18	1.60	1.09	1.24	.39	10

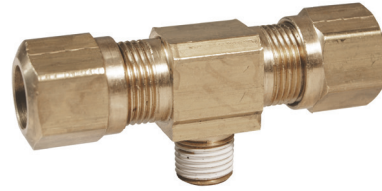
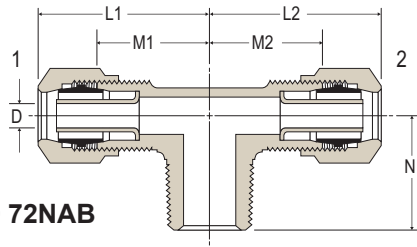

TE DE RAMIFICACIÓN MACHO 72NAB

Referencia SAE 100425 BA

Sellador de roscas puede ser blanco o naranja quemado

Número de Parte	Tubo 1	Tubo 2	Rosca Tubería	Rosca Recta	L ¹	L ²	M ¹	M ²	N	Fluj D	Cant. por Caja
72NAB32VS	3/16	3/16	1/8	7/16-24	.90	.90	.61	.61	.66	.087	10
72NAB42VS	1/4	1/4	1/8	7/16-24	.95	.95	.62	.62	.66	.13	10
72NAB44VS		1/4	1/4	7/16-24	1.00	1.00	.68	.68	.87	.13	10
72NAB62VS	3/8	3/8	1/8	17/32-24	1.18	1.18	.72	.72	.75	.217	10
72NAB64VS		3/8	1/4	17/32-24	1.25	1.25	.81	.81	.92	.21	10
72NAB66VS		3/8	3/8	17/32-24	1.30	1.30	.84	.84	.91	.21	10
72NAB84VS	1/2	1/2	1/4	11/16-20	1.41	1.41	.89	.89	.99	.33	10
72NAB86VS		1/2	3/8	11/16-20	1.45	1.45	.93	.93	.99	.33	10
72NAB88VS		1/2	1/2	11/16-20	1.55	1.55	1.03	1.03	1.17	.33	10
72NAB108VS	5/8	5/8	1/2	13/16-18	1.60	1.60	1.09	1.09	1.24	.39	10

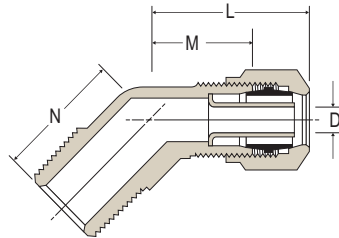

CODO 45° 79NAB

Referencia SAE 100302 BA

Sellador de roscas puede ser blanco o naranja quemado

Número de Parte	Tamaño de Tubo	Rosca de Tubería	Rosca Recta	L	M	N	Flujo D	Cant. por Caja
79NAB42VS	1/4	1/8	7/16-24	.81	.49	.63	.13	10
79NAB44VS		1/4	7/16-24	.93	.60	.85	.13	10
79NAB62VS	3/8	1/8	17/32-24	1.17	.71	.68	.21	10
79NAB64VS		1/4	17/32-24	1.17	.71	.85	.21	10
79NAB66VS		3/8	17/32-24	1.21	.75	.94	.21	10
79NAB68VS	1/2	1/2	17/32-24	1.24	.78	1.16	.21	10
79NAB84VS		1/4	11/16-20	1.36	.84	.94	.33	10
79NAB86VS		1/2	3/8	11/16-20	1.36	.84	.94	.33
79NAB88VS	5/8	1/2	11/16-20	1.39	.87	1.16	.33	10
79NAB106VS		3/8	13/16-18	1.43	.94	.98	.39	5
79NAB108VS		1/2	13/16-18	1.42	.93	1.16	.39	5
79NAB128VS	3/4	1/2	1-18	1.61	1.10	1.18	.51	2

CONEXIONES PARA FRENOS DE AIRE - MANGUERA DE HULE

Aplicación:

- Para uso con manguera de freno de aire SAEJ1402 en ensambles de manguera

Cumplimientos:

- Cumple con D.O.T. FMVSS 571-106 cuando se usa con la manguera de freno de aire SAE J1402

Material:

- Latón: Aleación 360

Desempeño:

- Presión de trabajo: hasta **225 PSI**
- Temperatura: **-50°F a +212°F**

Instrucciones de Ensamble:

1. Desliza la tuerca en la manguera
2. Desliza la manga en la manguera con el extremo cónico hacia la conexión.
3. Fija firmemente las conexiones en la manguera
4. Ajusta la tuerca al cuerpo hasta que haga contacto con el hexágono del cuerpo de la conexión

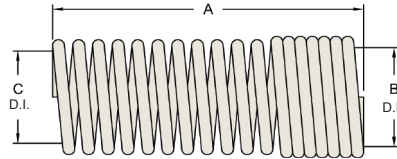

56RBSG Resorte

Número de Parte	Tamaño manguera	A	B	C	Cant. por Caja
56RBSG-06	3/8	2.70	.87	.87	5
56RBSG-08	1/2	2.70	.96	.96	5

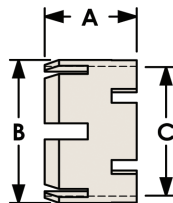

60RB Manga

Número de Parte	Tamaño manguera	A Longitud	B D.E.	C D.I.	Cant. por Caja
60RB-06	3/8	.64	.91	.80	10
60RB-08	1/2	.64	1.02	.92	5

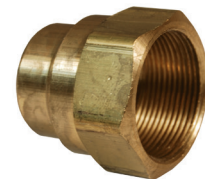
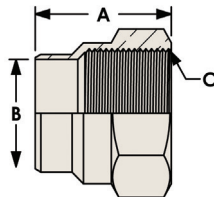

61RB Tuerca

Número de Parte	Tamaño manguera	C Rosca	Hex	A Longitud	B D.I.	Cant. por Caja
61RB-06	3/8	31/32-20	1-1/32	1.13	.78	10
61RB-08	1/2	1-3/32-20	1-1/4	1.20	.92	10

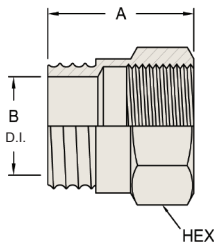

61RBSG Tuerca con Resorte de Guarda

Número de Parte	Tamaño manguera	Rosca Recta	Hex	A	B	Cant. por Caja
61RBSG-06	3/8	31/32-20	1-1/32	1.20	.78	5
61RBSG-08	1/2	1-3/32-20	1-1/4	1.20	.92	5

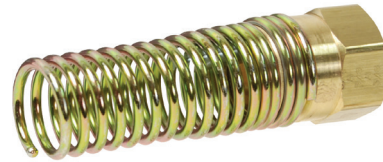
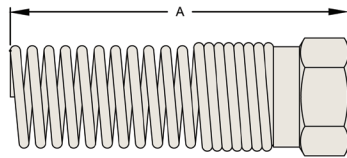

67RBSG

Tuerca con Resorte Protector de Manguera

Número de Parte	Longitud	Cant. por Caja
67RBSG-06	3.55	5
67RBSG-08	3.50	5

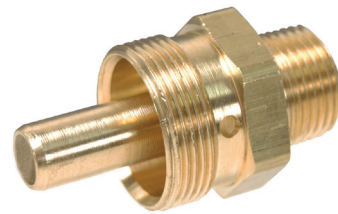
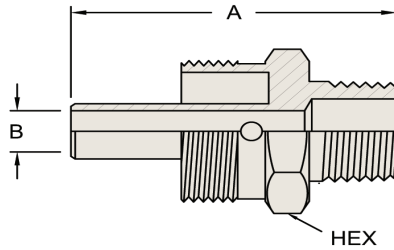

68RB

Conector Macho - Cuerpo Solamente

Número de Parte	Tamaño de Manguera	Rosca Recta	Rosca de Tubería	Hex	A	B	Cant. por Caja
68RB-0604B	3/8	31/32-20	1/4	31/32	1.93	.299	10
68RB-0606B		31/32-20	3/8	31/32	1.93	.299	10
68RB-0608B		31/32-20	1/2	31/32	2.12	.299	10
68RB-0806B	1/2	1-3/32-20	3/8	1-1/8	1.96	.397	5
68RB-0808B		1-3/32-20	1/2	1-1/8	2.15	.397	5

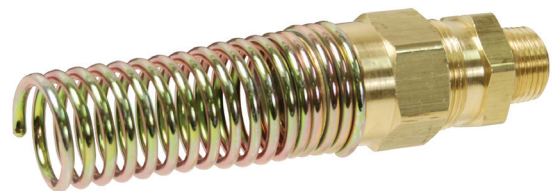
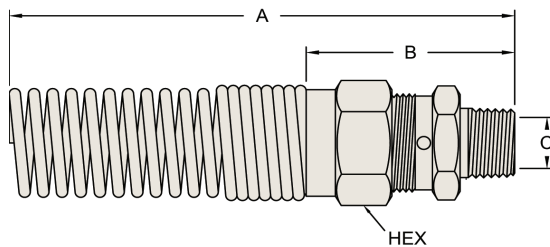

68RBSG

Conector Macho con Resorte Protector de Manguera

Número de Parte	Tamaño de Manguera	Rosca Recta	Hex	A	B	C	Cant. por Caja
68RBSG-0604	3/8	1/4	1-1/16	4.69	1.96	.299	2
68RBSG-0606		3/8	1-1/16	4.8	2.05	.299	2
68RBSG-0608		1/2	1-1/16	4.9	2.15	.299	2
68RBSG-0806	1/2	3/8	1-1/4	5.0	2.00	.397	2
68RBSG-0808		1/2	1-1/4	5.25	2.25	.397	2

Aplicaciones:

- Para usar con conexiones "Libres de Plomo"

Cumple con:

- Acta de Agua Potable (SWDA) en Enero 4, 2014.
- California AB1953
- RoHS

Materiales:

- Latón libre de plomo $\leq 0.25\%$ plomo
- Aleación CA2745
- Aleación C46400

Serie 102

Barba Macho - NPT



Número de Parte	DI Manguera x Macho Rosca NPT
1020302CLF	3/16 x 1/8
1020402CLF	1/4 x 1/8
1020404CLF	1/4 x 1/4
1020502CLF	5/16 x 1/8
1020504CLF	5/16 x 1/4
1020602CLF	3/8 x 1/8
1020604CLF	3/8 x 1/4
1020606CLF	3/8 x 3/8
1020608CLF	3/8 x 1/2
1020804CLF	1/2 x 1/4
1020806CLF	1/2 x 3/8
1020808CLF	1/2 x 1/2
1021008CLF	5/8 x 1/2
1021208CLF	3/4 x 1/2
1021212CLF	3/4 x 3/4

Serie 104

Barba Hembra - Rígida - NPT



Número de Parte	DI Manguera X Hembra Rosca NPT
1040404CLF	1/4 x 1/4
1040604CLF	3/8 x 1/4
1040606CLF	3/8 x 3/8
1040608CLF	3/8 x 1/2
1040808CLF	1/2 x 1/2

Serie 129

Codo 90° - NPT

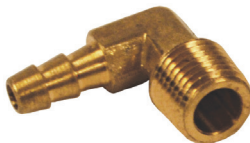

Número de Parte	DI Manguera x NPT Macho
1290404CLF	1/4 x 1/4
1290604CLF	3/8 x 1/4
1290606CLF	3/8 x 3/8

Serie 143

Hembra Giratoria - Doble Asiento

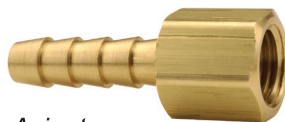

Número de Parte	DI Manguera x DE Tubo x Rosca UNF
1430407KLF	1/4 x 1/4 x 7/16-20

Serie 163

Tapón con cabeza hexagonal - NPT



Número de Parte	Rosca NPT
1630200CLF	1/8
1630400CLF	1/4

Serie 165

Niple corto con rosca - NPT

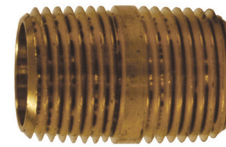

Número de Parte	Rosca NPT x Rosca NPT
1650202CLF	1/8 x 1/8
1650404CLF	1/4 x 1/4
1650606CLF	3/8 x 3/8
1650808CLF	1/2 x 1/2
1651212CLF	3/4 x 3/4

Serie 166

Niple largo con rosca - NPT



Número de Parte	Rosca NPT x OAL
1660230CLF	1/8 x 3"
1660240CLF	1/8 x 4"
1660415CLF	1/4 x 1 1/2"
1660420CLF	1/4 x 2"
1660430CLF	1/4 x 3"
1660440CLF	1/4 x 4"
1660615CLF	3/8 x 1 1/2"
1660620CLF	3/8 x 2"
1660625CLF	3/8 x 2 1/2"
1660630CLF	3/8 x 3"
1660640CLF	3/8 x 4"
1660815CLF	1/2 x 1 1/2"

Serie 178

Unión de Manguera



Número de Parte	DI Manguera x DI Manguera
1780404CLF	1/4 x 1/4
1780606CLF	3/8 x 3/8
1780808CLF	1/2 x 1/2

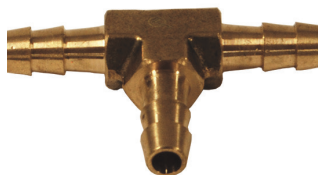

Serie 179
Te Unión

Número de Parte	DI Manguera
1790404CLF	1/4 x 1/4 x 1/4
1790606CLF	3/8 x 3/8 x 3/8

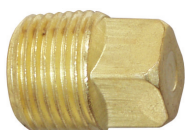

Serie 211
Tapones de Cabeza Cuadrada - PTF

Número de Parte	Rosca PTF
2110200C	1/8
2110400C	1/4
2110600C	3/8
2110800C	1/2
2111200C	3/4



Serie 213
Tapón - NPT

Número de Parte	Rosca NPT
2130200CLF	1/8
2130400CLF	1/4
2130600CLF	3/8
2130800CLF	1/2
2131200CLF	3/4



Serie 219
Tapón Hexagonal - NPT

Número de Parte	Rosca NPT
2190200C	1/8
2190400C	1/4
2190600C	3/8
2190800C	1/2
2191200C	3/4

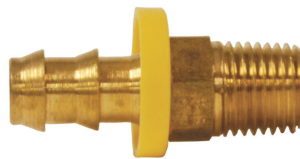

Serie 272
Macho NPTF Rígido "Lok-On"

Número de Parte	DI Manguera x Macho Rosca NPT
2720402CLF	1/4 x 1/8
2720404CLF	1/4 x 1/4
2720604CLF	3/8 x 1/4
2720606CLF	3/8 x 3/8
2720806CLF	1/2 x 3/8
2720808CLF	1/2 x 1/2



Serie 287
Hembra Giratoria SAE 45°/37° JIC "Lok-On" -
Doble Asiento

Número de Parte	DI Manguera x DE Tubo x Rosca UNF
2870407CLF	1/4x 1/4 x 7/16-20



Serie 302
Codo Hembra 90° - NPT

Número de Parte	Rosca NPT
3020404CLF	1/4
3020606CLF	3/8
3020808CLF	1/2
3021212CLF	3/4



Serie 304
Codo 90° - NPT

Número de Parte	Rosca NPT
3040202CLF	1/8 x 1/8
3040404CLF	1/4 x 1/4
3040606CLF	3/8 x 3/8
3040808CLF	1/2 x 1/2



Serie 322
Te Hembra - NPT

Número de Parte	Rosca NPT
3220202CLF	1/8
3220404CLF	1/4
3220606CLF	3/8
3220808CLF	1/2
3221212CLF	3/4



Serie 371
Acople Hex Hembra - NPT

Número de Parte	Rosca Hembra
3710202CLF	1/8 x 1/8
3710404CLF	1/4 x 1/4
3710606CLF	3/8 x 3/8
3710808CLF	1/2 x 1/2



Serie 324
Te de Ramificación Macho - NPT

Número de Parte	Rosca NPT
3240606CLF	3/8

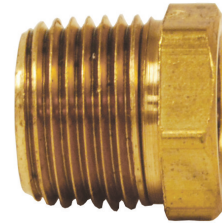

Serie 373
Bushing Reductor - NPT

Número de Parte	NPT Macho x Rosca NPT Hembra
3730402CLF	1/4 x 1/8
3730604CLF	3/8 x 1/4
3730804CLF	1/2 x 1/4
3730806CLF	1/2 x 3/8
3731208CLF	3/4 x 1/2

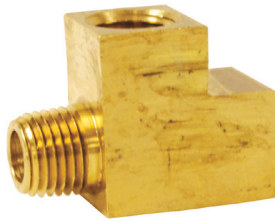

Serie 326
Te Codo - NPT

Número de Parte	Rosca NPT
3260404CLF	1/4

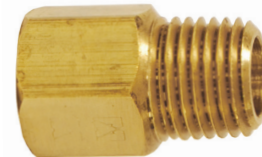

Serie 375
Adaptador - NPT

Número de Parte	Hembra NPT x Macho NPT
3750402CLF	1/4 x 1/8
3750404CLF	1/4 x 1/4
3750604CLF	3/8 x 1/4
3750808CLF	1/2 x 1/2
3751212CLF	3/4 x 3/4

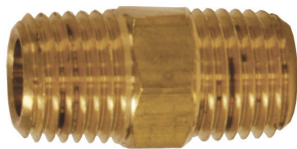

Serie 370
Niple Macho Hex - NPT

Número de Parte	Rosca NPT
3700202CLF	1/8 x 1/8
3700404CLF	1/4 x 1/4
3700606CLF	3/8 x 3/8
3700808CLF	1/2 x 1/2



Serie 377
Cople Reductor - NPT

Número de Parte	Hembra NPT x Hembra NPT
3770806CLF	1/2 x 3/8
3771208CLF	3/4 x 1/2



Serie 502
Hembra GHT Giratoria x Hembra NPTF

Número de Parte	Rosca GH x Rosca NPT
5021208CLF	$\frac{3}{4} \times \frac{1}{2}$
5021212CLF	$\frac{3}{4} \times \frac{3}{4}$



Serie 509
Macho x Macho x Hembra

Número de Parte	Macho GH x Macho GH x Hembra NPT
5091212CLF	$\frac{3}{4} \times \frac{3}{4} \times \frac{1}{2}$



Serie 506
Hembra GHT x Hembra GHT Giratoria

Número de Parte	Hembra GH x Hembra GH
5061212CLF	$\frac{3}{4} \times \frac{3}{4}$



Serie 514
Macho x Macho x Hembra

Número de Parte	Macho GH x Macho NPT x Hembra NPT
5141212CLF	$\frac{3}{4} \times \frac{3}{4} \times \frac{1}{2}$



Serie 507
Macho GHT x Hembra NPTF

Número de Parte	Macho GH x Hembra NPT
5071212CLF	$\frac{3}{4} \times \frac{3}{4}$

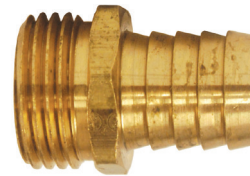

Serie 590
Macho GHT

Número de Parte	DI Manguera x Macho GH
5900812CLF	$\frac{1}{2} \times \frac{3}{4}$
5901012CLF	$\frac{5}{8} \times \frac{3}{4}$
5901212CLF	$\frac{3}{4} \times \frac{3}{4}$

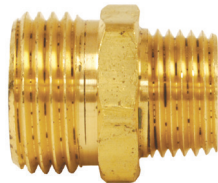

Serie 508
Macho GHT x Macho NPTF

Número de Parte	Macho GH x Macho NPT
5081208CLF	$\frac{3}{4} \times \frac{1}{2}$



Serie 591
Hembra Tuerca Giratoria Maquinada

Número de Parte	DI Manguera x Hembra GH
5910812CLF	$\frac{1}{2} \times \frac{3}{4}$
5911012CLF	$\frac{5}{8} \times \frac{3}{4}$
5911212CLF	$\frac{3}{4} \times \frac{3}{4}$

Libre de Plomo

¿Cuál es el nuevo requerimiento "Libre de Plomo"?

En 2011, el acta de Reducción de Plomo en Agua Potable se convirtió en ley en los Estados Unidos. El acta redujo el contenido de plomo de los sistemas de agua potable y materiales de plomería cambiando la definición de "Libre de Plomo" en la Sección 1417 de el Acta de Agua Potable (SDWA). La nueva ley entro en vigor el 4 de julio del 2014.

Definición de "Libre de Plomo"

El término "libre de plomo" ha sido actualizado a no más de 8%, cumpliendo con "no más del promedio 0.25% de plomo usado en superficies de contacto, conexiones de tubería, plomería y accesorios."

Excepciones "Libres de Plomo"

El nuevo requerimiento no aplica a tubería, conexiones o accesorios, incluyendo preventores de contraflujo, que son usados exclusivamente para servicios no-potables, como fabricas, procesamiento industrial, irrigación, riego exterior, o cualquier uso donde el agua no para consumo humano.

Partes estándar en Laton de Dixon Brass

Nuestras partes de latón son de aleación CDA 353, 360 ó 377 maquinado. El contenido de plomo es de 2.5 a 3.7%. Nuestros productos de latón son producidos de aleación C3604B con contenido de plomo de 1.8% - 3.7%. Estas aleaciones de latón no cumplen con los requerimientos del Acta de Agua Potable. Las partes Dixon Brass se encuentran dentro del nivel aceptable de plomo en latón para RoHS Directive 2001/65/EU. La excepción es Annex 6(C) para aleación de cobre que contenga 4% del peso en plomo. Las partes Dixon Brass también son libres de mercurio.

La opción LF en el catálogo

Estamos ofreciendo una selección de productos "Libres de Plomo". Esto se denota con la terminación "LF" al final de cada número de parte estándar. La opción "LF" será funcionalmente la misma que la opción de latón, pero el diseño y las dimensiones pueden cambiar. Todas las partes con la terminación "LF" tendrán $\leq 0.25\%$ de plomo y cumplirá con la definición "lead free" en la Sección 1417 de el Acta de Agua Potable. Por favor contacte a Dixon si requiere productos "libres de plomo" adicionales fuera del listado en este catálogo.



Comparación de Medidas

Diámetro Exterior Actual de Roscas de Tubería

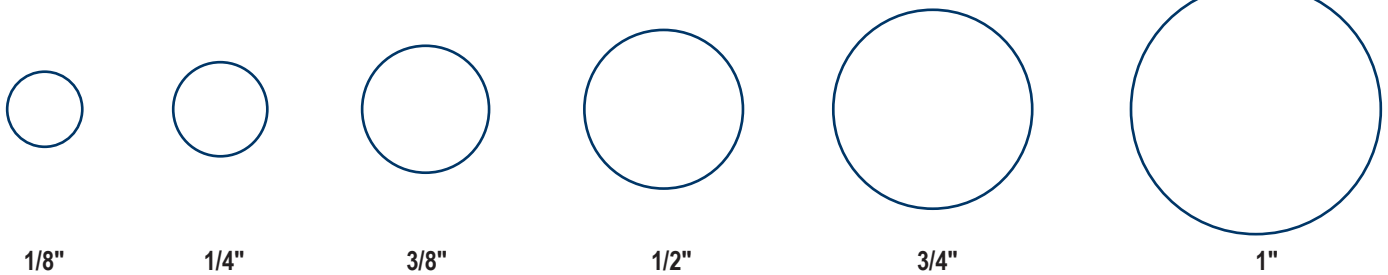

Diámetro Exterior Actual de Tubing

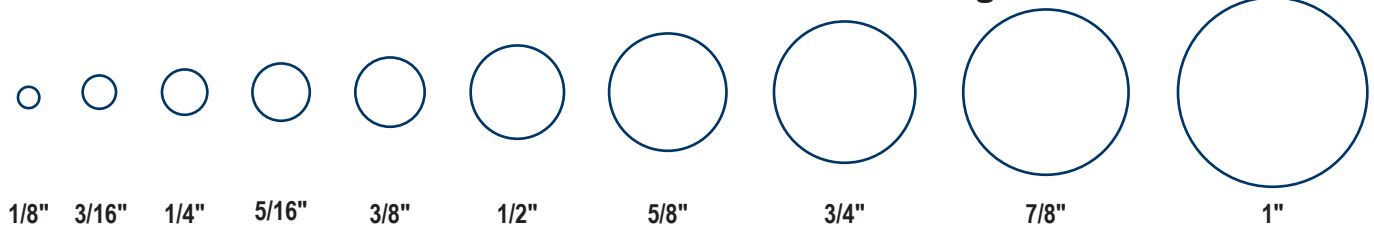

Perfiles de Rosca Macho



Información de Roscas

Abreviación	Nombre	Compatibilidad	Tipo de Sello
BSPP	British Standard Pipe Parallel	BSPP Macho con BSPP Hembra	Arandela
		BSPP Hembra con BSPP Macho	Arandela
		BSPP Hembra con BSPTTr Macho	Arandela
BSPTTr	British Standard Pipe Taper	BSPTTr Macho BSPTTr Hembra	Rosca
		BSPTTr Macho con BSPP Hembra	Arandela
		BSPTTr Hembra con BSPTTr Macho <i>BSPTTr Hembra no es compatible con BSPP Macho</i>	Rosca
CHT	American Standard Fire Hose Thread (1" National Hose Thread es Chemical Hose Thread , también conocida como Booster Hose Thread)	NH (NST) Macho 1" con NH (NST) Hembra 1"	Arandela
		NH (NST) Hembra 1" con NH (NST) Macho 1"	Arandela
		Rosca de 1" es usada en la mang. de 3/4" y la de 1". <i>No es compatible con otros sistemas</i>	No compatible
GHT	Garden Hose Thread	GHT Macho con GHT Hembra	Arandela
		Hembra GHT con Macho GHT	Arandela
		Misma rosca para todos los tamaños de mangueras	No compatible
IPS	Iron Pipe Straight Thread	Nombre genérico de 'Straight Pipe Thread'	Arandela
IPT	Iron Pipe Thread	Nombre genérico para todas las 'Pipe Thread'	se requiere de más información
JIC	Joint Industrial Committee	Se usa con otras roscas coincidentes JIC	Mecánica
NH ó NST	American Standard Fire Hose Coupling Thread (National Hose thread también conocido como National Standard Thread)	NH (NST) Macho con NH (NST) Hembra NH (NST) Hembra con NH (NST) Macho <i>No es compatible con otros sistemas.</i>	Arandela
		El paso de la rosca y diámetro puede variar dependiendo de las regulaciones locales y municipales.	Arandela
NPT	American Standard Taper Pipe Thread (National Pipe Tapered)	NPT Macho con NPT Hembra	Rosca
		NPT Macho con NPTF Hembra	Rosca
		NPT Macho con NPSM Hembra	Arandela
		NPT Macho con NPSH Hembra	Arandela
		NPT Macho con NPT Macho	Rosca
		NPT Hembra con NPTF Macho <i>NPT Hembra no es compatible con NPSM Macho ó NPSH Macho</i>	Rosca
NPTF	American Standard Taper Pipe Fuel Dryseal Thread (National Pipe Tapered Dryseal)	NPTF Macho con NPTF Hembra	Rosca
		NPTF Macho con NPT Hembra	Rosca
		NPTF Macho con NPSM Hembra	Arandela
		NPTF Macho con NPSH Macho	Arandela
		NPTF Hembra con NPTF Macho	Rosca
		NPTF Hembra con NPT Macho	Rosca
		NPTF Hembra con NPSM Macho ó NPSH <i>Roscas NPTF con NPTF no necesitan sellador para uso inicial. Luego, el uso de sellador es necesario.</i>	No compatible
NPSH	American Standard Straight Pipe for Hose Couplings (National Pipe Straight Hose)	NPSH Macho con NPSH Hembra	Arandela
		NPSH Hembra con NPSH Macho	Arandela
		NPSH Hembra con NPT Macho	Arandela
		NPSH Hembra con NPTF Macho	Arandela
		NPSH Hembra con NPSM Macho	Arandela
NPSM	American Standard Straight Mechanical Joints (National Pipe Straight Mechanical)	NPSM Macho con NPSM Hembra	El sello puede ser mecánico o de arandela.
		NPSM Macho con NPSH Hembra	
		NPSM Hembra con NPSM Macho	
		NPSM Hembra con NPT Macho	
		NPSM Hembra con NPTF Macho	
SIPT	Straight Iron Pipe Thread	Nombre genérico para Straight Pipe Thread (Rosca recta de tubo)	Arandela
TIPT	Tapered Iron Pipe Thread	Nombre genérico para Tapered Pipe Thread	Rosca
NYC	NYC Fire Department	Rosca Recta utilizada en la ciudad de Nueva York	Arandela
Chicago	Chicago Fire Department	Rosca recta utilizada en Chicago	Arandela

Garantía Limitada

DIXON VALVE AND COUPLING COMPANY (aquí llamada Dixon) garantiza que los productos aquí descritos, y fabricados por Dixon, son libres de defectos en materiales y mano de obra por el periodo de (1) un año desde la fecha de envío por Dixon bajo servicio y uso normal. Su única obligación bajo esta garantía se limita a reparar o reemplazar, como se menciona más adelante, cualquier producto que Dixon encuentre defectuoso bajo su inspección, regresando dicho producto a fábrica para su inspección dentro de (3) tres meses después de haber descubierto el defecto. La reparación o reemplazo de los productos defectuosos serán sin cargo por partes o mano de obra. Esta garantía no aplica a: (a) las partes o productos no fabricados por Dixon la garantía de dichos artículos esta limitada a la garantía actual ofrecida a Dixon por su proveedor; (b) cualquier producto que ha estado sujeto a abuso, negligencia, accidente o mala aplicación; (c) cualquier producto alterado o reparado por otros que no son Dixon; y (d) el servicio de mantenimiento regular y reemplazo de ítems del servicio (como arandelas, empaques y lubricantes) haciendo conexión. Esta garantía limitada se extiende solo al comprador directo y cualquier otra persona que demuestre ser usuario o consumidor de los productos y que sea lastimado en su persona por cualquier incumplimiento de esta garantía. Ninguna acción podrá ser formulada en contra de Dixon por su supuesto incumplimiento de garantía a menos que dicha acción sea instituida dentro del periodo de garantía del producto.

A parte de la obligación de Dixon aquí expuesta, Dixon desconoce toda garantía, expresa o implícita, incluyendo pero no limitada a cualquier garantía implícita de comerciabilidad o conveniencia para un propósito particular, y cualquier otra obligación o responsabilidad. Lo precedente constituye la única obligación de Dixon con relación a daños, ya sean directos, incidentales o consecuentes, que resulten del uso o desempeño del producto.

Algunos productos y medidas pueden ser discontinuadas cuando el inventario sea agotado, o pueden requerir de una cantidad mínima ordenarse.

Límites de Responsabilidad

Este catálogo esta hecho como oferta de producto. No es un manual de usuario o técnico. La información en este catálogo esta sujeta a cambios sin previo aviso. Todos los usuarios y distribuidores de productos vendiendo a través de este catálogo deben contactar a Dixon por cuestiones de uso, compatibilidad, procedimientos de acoplamiento y vida del producto. Nuestro equipo de ingeniería y prueba siempre está disponible para recomendar usos y asistir a los distribuidores y usuarios por cualquier duda.



Seguridad



Los logotipos de seguridad, aparecen en todo el catálogo, son usados como un recordatorio que el usuario debe revisar propiamente el medio del producto en la aplicación y ambiente en donde será utilizado.

NOTA: Debido a los peligros asociados con la contaminación y contenido de plomo en sistemas de agua potable, Dixon, a menos que especifique lo contrario, no recomienda el uso en servicio de agua potable y no debe ser usado en aplicaciones donde el agua potable este en contacto con las partes internas del acople.

Precaución: los productos Dixon pueden contener químicos reconocidos por el estado de California como causantes de cáncer, defectos de nacimiento y otros peligros de reproducción.

Dixon en México

Av. Churubusco #1600
Local 14, Plaza Jumbo
Col. Francisco I. Madero 64560
Monterrey, Nuevo León
Tel. (81) 8354-5649
800.00.DIXON (34966)
contactenos@dixonvalve.com.mx
dixonvalve.com.mx

Dixon en los Estados Unidos

225 Talbot Blvd.
Chestertown, MD. 21620
Tel: 410.810.7585
Fax: 410. 778.1958
export@dixonvalve.com
dixonvalve.com



La Conexión Correcta™

Para más información visita
dixonvalve.com



Pregunta por nuestros catálogos:

Dixon Sanitary

Conexiones y Válvulas para la industria alimenticia.

Dixon Fire

Conexiones y Mangueras para la prevención y combate contra incendios.

Dixon Quick Coupling

Acoples de Conexión Rápida para Aplicaciones Hidráulicas y Neumáticas.

Dixon-Bayco Petroleum

Conexiones para almacenamiento y despacho de combustible

Dixon-Bayco Dry Bulk

Conexiones para y tolvas con carga seca

MANUFACTURA • CALIDAD • SERVICIO • MANUFACTURA • CALIDAD • SERVICIO • MANUFACTURA • CALI