

SERVICIO PESADO



MASTER SERVICIO PESADO 2014

CARGA / PASAJE 1990 - 2014

GATES DE MÉXICO

Gates

LA LÍNEA MÁS COMPLETA EN SERVICIO PESADO



MARCA DE PESO EN SERVICIO PESADO

Contamos con el paquete más completo de productos de servicio pesado



www.Gates.com.mx



Bandas PQ®
Bandas GS®
Bandas Tripower®
Bandas Powerband®
Bandas Hi-Power®B Heavy Duty
Termostatos HD
Tapón de Radiador

Bandas TR®
Poleas
Tensores
Bombas de Dirección Hidráulica
Ensamblajes Hidráulicos
Tubing de Nylon
Conexiones Push-In

Bandas Super HC®
Micro-V AT®
Kit de Banda Micro V®
Bombas de Agua HD
Mangueras de Radiador CH
Manguera de Silicón
Manguera Charter®

Manguera Durion®
Diafragmas
Coil de Frenos
Destelladores
Plumas Limpiaparabrisas
Manguera Twister®
Mangueras 35B



ÍNDICE

PRODUCTOS GATES

Característica y especificaciones

Tensores automáticos para bandas Micro-V®

Bandas Micro-V® AT (Serpentín)

Bandas Micro-V® de Doble lado

TR y XL® bandas en V

Bandas Timing para árbol de levas

Bandas Hi-Power® II

Bandas Tri-Power®

Bandas Vulco®

Bandas PowerBand®

C5C Manguera Hidráulica SAE 100R5

C5D Manguera Alta Temperatura (Multifluido)

Manguera Marina C5M (Línea Combustible)

Manguera Flexline C5E de Alta Temperatura

Manguera ACR-MegaTech®

Manguera C14 PTFE

Calibradores (Medidores) de presión

Infladores-Calibradores

Pistolas para aire y otros fluidos

Tubeing de Nylon para Frenos de Aire (TNFA)

Ensamblajes para Frenos de aire en espiral

Conectores Puch-In

Herramientas:

Alineador Láser DriveAlign™

Medidor Banda Micro-V®

Localizador Banda-V
Herramienta para tensar las bandas de Serpentin

Mangueras de Enfriamiento

Curvas

Twister

Charter

Durion® para Radiador

Durion® para Calefacción

Conector Vibraflex

Mangueras de Combustible

FLH

FLC

MPI / Fuel Injection

Sumergible

Fuel Fill

Filler Neck

30T

Mangueras de Ventilación

Turbocargador Recta sin anillos

Turbocargador con anillos

Conector recto con joroba

Conector recto flexible

Conector reductor recto con joroba

Codos moldeados

Codos reductores moldeados

4106 Manguera de limpiaparabrisas

Reductores de diámetro

Diafragmas

Cintas Antiestáticas

Unicoil

Manguera de Enfriamiento del Aceite de Transmisión

Manguera Recta de Silicón

Codos de Silicón 45° y 90°

Manguera de Silicón para Turbocargador con anillos

Manguera Durion HH para Calefacción

Mangueras de Aplicaciones Especiales

FORMAS Y DIMENSIONES

Guía de Poleas DriveAlign®

Guía de Tensores para Micro-V®

DriveAlign®

Nomenclatura de Bandas:

Banda V Dentada

Banda GS® PLATINUM QUALITY

Banda Vulco®

Banda Super HC®

Banda Truck Belt

Banda PowerBand®

Banda Tri-Power®

Banda Hi-Power® II

Banda Micro-V®

Abrazaderas

Destelladores (Flashers) - TRIDON

Tapón de radiador

Termostato

Limpiaparabrisas- Servicio Pesado

Bombas de Servicio Pesado

Bombas de Agua de Servicio Pesado

Bombas de DH de Servicio Pesado

UNIDADES DE REFRIGERACION

APLICACIÓN POR ARMADORA

CHEVROLET

C4500

C5500

C6500

C7500

C8500

KODIAK

s

s

s

s

t

t

t

u

u

v

w

x

y

z

aa

ab

Ab

ae

ag

ah

ah

ai

ai

aj

aj

ak

ak

al

al

ao

aq

ar

as

as

au

av

aw

ay

ay

bc

T6500

T7500

T8500

DINA

102 F

104-R

104-SF

94 F

AVANTE

CITUS

D-500 HTQ

D-600 HTQ

D-7400 HTQ

D-9400

D-9400 EAGLE

DORADO

F-11

LINNER

MARCOPOLO GV850

MARCOPOLO PARADISO

MARCOPOLO VIAGGIO GV1000

OUTSIDER

S-400

S-500

S-500 CORAZA

S-600

S-700

URBANO

DODGE

D-600

RAM-4000

RAM-6500

FORD

E450 SUPER DUTY

E550 SUPER DUTY

F-350 SUPER DUTY

F-450 SUPER DUTY

F-550 SUPER DUTY

F-600

F-650 SUPER DUTY

F-750 SUPER DUTY

F-800

FREIGHTLINER

ARGOSY

BUSINESS CLASS M2

CASCADIA

CENTURY CLASS

CLASSIC

CLASSIC XL

COLUMBIA

CORONADO

FL112

FLC

22

22

23

23

23

23

24

24

24

25

25

25

25

26

26

26

26

27

27

27

28

28

30

31

32

33

34

35

35

38

38

41

41

42

44

47

50

53

56

56

63

68

69

81

87

93

103

107

111



MASTER SERVICIO PESADO 2014

ÍNDICE

FLD	123	9800	245	T600A	330
FLD120	154	9900	246	T660	330
GIANT MOTORS		9900i	247	T800	333
GF-3600	157	9900iX	254	W900	364
GF-8	157	BE	259	MACK	
GF-900	157	CE	260	CH SERIES	384
HINO		CF500	261	CHN SERIES	385
1018 SERIE 500	157	CF600	261	CHU SERIES	385
1524 SERIE 500	158	CONVENTIONAL IC	261	CL SERIES	386
1714 SERIE 500	158	CXT	262	CS SERIES	387
1727 SERIE 500	158	DURASTAR 4300	262	CT SERIES	387
414 SERIE 300	158	DURASTAR 4400	263	CTP SERIES	387
514 SERIE 300	158	FE	263	CV SERIES	387
616 SERIE 300	158	LONESTAR	264	CX SERIES	388
716 SERIE 300	158	MXT	264	CXN SERIES	389
816 SERIE 300	159	PAYSTAR	264	CXP SERIES	389
INTERNATIONAL/NAVISTAR		PAYSTAR 5500i	267	CXU SERIES	389
3000FE	159	PAYSTAR 5600i	267	DM SERIES	390
3300	159	PAYSTAR 5900i	267	GRANITE	390
3400	160	PROSTAR SERIES	267	GU SERIES	390
3600	160	RE	269	LE SERIES	391
3800	160	TRANSTAR 8500	271	MR SERIES	391
4100	161	TRANSTAR 8600	271	RB SERIES	392
4200	161	WORKSTAR 7300	271	RD SERIES	392
4300	162	WORKSTAR 7400	271	MASA	
4400	163	WORKSTAR 7500	272	ESTRADA	392
4600	164	WORKSTAR 7600	272	PREMIER	392
4700	165	WORKSTAR 7700	273	MERCEDES BENZ	
4800	168	IRIZAR		0371 RS	393
4900	171	INTERCENTURY	273	1114	395
5000	174	MAN A-82	273	1314	395
5500	179	MAN AUTOMATICO	274	1317	395
5500i	179	MAN PANORAMICO	274	1417	396
5600	183	MAN R-33	274	1517	396
5600i	183	ISUZU		1521	397
5900i	187	ELF 200	274	2121	397
7100	191	ELF 300	275	ALBATROS	397
7300	192	ELF 400	276	ALEGRO	398
7400	192	ELF 450	276	AUTOBUS INTEGRAL	398
7500	194	ELF 500	276	BOXER	398
7600	195	ELF 600	277	BUSS 320	399
7700	198	ELF 600 BUS	277	BUSSCAR	399
8100	199	FORWARD 800	278	CENTURY CLASS	400
8200	206	KENWORTH		MARCOPOLO	401
8500	209	C500	278	MARCOPOLO ANDARE	401
8600	210	C550	282	MULTEGO	402
9000	212	K100	282	TORINO	402
9100	212	K300	287	TURICLASS	403
9100i	214	T2000	288	NEOPLAN	
9200	217	T300	296	NEOBUS	403
9200i	221	T370	299	NEOPLAN 2 PISOS	404
9300	227	T400	299	NISSAN	
9400	231	T400A	301	CABSTAR	404
9400i	237	T450	304		
9600	243	T450B	308		
9700	244	T600	308		



ÍNDICE

SCANIA					
IRIZAR I5	405		FIAT		
IRIZAR I6	405		DUCATO	465	BANDAS MICRO-V
SCANIA	405				BANDAS PQ
SCANIA PARADISO	406		FORD		BANDAS TIMING
			COURIER	466	BANDAS TR
STERLING			F-350 SUPER DUTY	468	MANGUERAS CH
360	406		F-450 SUPER DUTY	470	MANGUERA 30T/35B
ACTERRA	407		F-550 SUPER DUTY	475	MANGUERA CHARTER
A-LINE	410		RANGER	476	MANGUERA SILICÓN
BULLET	417		TRANSIT	483	TAPÓN DE ACEITE
L-LINE	417				TAPÓN DE RADIADOR
SILVER STAR	428		HYUNDAI		TAPÓN DE GASOLINA
TORTON	428		H100	484	POLEAS
TRACTO	428		H100 VAN/WAGON	486	SENSORES
			VAN 1000	487	EQUIVALENCIAS
VOLKSWAGEN					
15-190 WORKER	429		MERCEDES BENZ		
17-210 VOLKSBUS	429		SPRINTER	487	
17-250 WORKER	429		VITO	490	
17-280 CONSTELLATION	430				
24-250 WORKER	430		NISSAN		
24-280 CONSTELLATION	430		CHASIS	491	
8-150 VOLKSBUS	430		ESTAQUITAS	492	
8-150 WORKER	431		NP300	494	
9-150 VOLKSBUS	431		NV2500	495	
9-150 WORKER	431		PICK-UP	495	
			URVAN	497	
VOLVO					
7350	431		PEUGEOT		
7550	432		EXPERT	499	
7550 FL	432		MANAGER	499	
9300	433		PARTNER	500	
9700	433		PARTNER MAXI	501	
9700 FL	434				
AUTOCAR	434		RENAULT		
C11R URBANO	436		KANGOO	501	
FE SERIES	437		KANGOO EXPRESS	501	
VHD	437		TRAFIC	503	
VNL	438				
VNL 64T	445		TOYOTA		
VNM	446		HIACE	503	
VT SERIES	450				
VT880	451		VOLKSWAGEN		
WCA SERIES	451		CRAFTER	504	
WG SERIES	452		EUROVAN	505	
WIA SERIES	454		PANEL	507	
XPEDITOR	457		SAVEIRO	508	
			TRANSPORTER	509	
			VW VAN	509	
				322	
UTILITARIOS			APLICACIÓN POR PRODUCTO		
CHEVROLET			BANDAS POWERBAND	511	
LUV	459		BANDAS GS	516	
S-10	459		BANDAS HIPOWER/TRIPOWER	527	
TORNADO	464				



POWERING PROGRESS™

MARCA DE PESO EN SERVICIO PESADO

Contamos con el paquete más **completo** de productos
de **servicio pesado**



VISITA NUESTRA PÁGINA DE INTERNET PARA CONSULTAR INFORMACIÓN ACTUALIZADA



En nuestro sitio WEB podrás consultar todas las características y especificaciones de nuestros productos, así mismo, podrás descargar los catálogos vigentes, Revistas “Sin Parar” y Boletines en formato electrónico.

También podrás navegar a los diferentes sitios de Gates a nivel mundial, en donde tendrás la oportunidad de consultar todos los productos Gates que aplican para un auto en específico, a través, de las siguientes direcciones:

Catálogo de aplicaciones de Gates USA:

http://www.gates.com/part_locator/index.cfm?go=part_locator&location_id=3598

Catálogo de aplicaciones de Gates en Europa:

<http://www.gatesautocat.com/?go=Gatesautocat>

www.Gates.com.mx



Tensores automáticos para bandas Micro-V® - DriveAlign® Servicio Pesado

Los tensores automáticos **DriveAlign®** de Gates exceden las especificaciones de equipo original y están disponibles para las principales marcas de Camiones y Autobuses a nivel mundial.

Los tensores DriveAlign® de Gates le ofrecen:

- Mejoran la vida útil de las Bandas Micro-V® AT
- Aumentan la vida útil de los accesorios
- Reducen costos de mantenimiento
- **Eliminan el ruido de la transmisión**



● ¿Qué es un tensor de bandas?

En el caso de Gates, no solamente es un tensor de bandas, es un tensor **automático** de bandas. Y es un dispositivo que permite aplicar fuerza constante a la banda, haciéndola trabajar a la tensión ideal.

● ¿Cómo funciona?

El tensor funciona de manera óptima solo si se cumplen los siguientes puntos:

- a) Dimensión correcta de la banda.
- b) Poleas bien alineadas.

Se recomienda hacer el recambio del tensor al mismo tiempo que las bandas y las poleas, esto con el propósito de mantener en óptimo desempeño todos sus componentes. Gates de México, le ofrece **Kits DriveAlign®** para bandas Micro-V® que incluyen el tensor, la banda MICRO-® AT y poleas.



Productos Gates * Características y especificaciones

1. BASE: Pieza fija del tensor que se acopla al bloque del motor o a otros accesorios. Los diseños de la base varían algunos componentes.

2. RESORTE: Precargado de fábrica, permite darle tensión a la banda .

3. AMORTIGUADOR: Permite autolubricar las partes internas del tensor.

4. BRAZO: Conecta el resorte con la polea del tensor. Generalmente es una cubierta de aluminio.

5. SELLO: Previene la contaminación interna.

6. POLEA: Puede ser metálico o termoplástico, acanalado o liso. La superficie de la polea se debe revisar constantemente para eliminar residuos que dañen la banda. El componente más importante de la polea es el balero. Para que una polea funcione correctamente, el balero debe ser lubricado correctamente. La causa más frecuente de la falla de la polea es pérdida de lubricación en los baleros. (No reemplace los baleros en una vieja polea).

7. CUBREPOLVO: Proteje al balero contra elementos contaminantes.

8. TORNILLO: Conecta a la polea con el brazo del tensor.

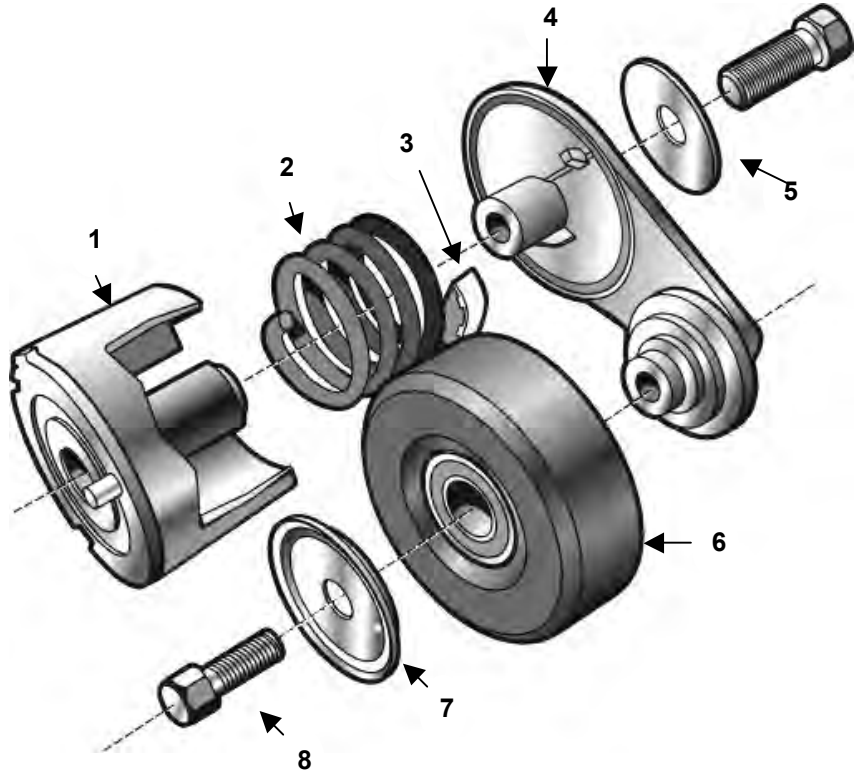

Productos Gates * Características y especificaciones



Bandas Micro-V® AT (Serpentín)

Bandas para serpentín, diseñadas para todas las marcas de automóviles en el mundo. Su diseño especial hace que la banda dure más del doble que su cercano competidor, en aplicaciones problemáticas.

- Silenciosas por su perfil desbastado y alta flexibilidad.
- Mínimo estiramiento por lo que no es necesario re-tensionar.
- Cuerda (refuerzo) de gran resistencia y durabilidad.
- Construido especialmente para resistir desgaste y agrietarse.
- Su diseño especial asegura un control dimensional exacto.
- Exceden las especificaciones de la norma SAE J1459.
(Tipo de Producto 8552 y 8160).



Bandas Micro-V® de Doble lado

Para reemplazar las bandas de serpentín de equipo original que requieren un grado más alto de eficacia al transmitir potencia. Diseñadas para las poleas de diámetro pequeños y para el uso con (o sin) los sensores automáticos.

- Pequeñas ranuras en V en ambos lados de la banda.
- Altamente resistente al aceite, al calor y a otras condiciones adversas.
- Amplia cobertura de aplicaciones.
- Exceden los estándares de la Asociación del Fabricante de Hule (RMA por sus siglas en inglés) para la conductividad estática.
- Exceden las especificaciones de la norma SAE J1459.



TR y XL® bandas en V

La banda más exigente en el Mercado de reemplazo. Su forma trapezoidal con ranuras le permite tener un mejor agarre a las poleas. Esto permite un mejor funcionamiento de la banda, reduciendo su elongación y ruido.

- La acción de su compuesto de hule y su refuerzo, dan mayor flexibilidad a lo largo de toda la banda, ofreciendo una mayor estabilidad en las poleas.
- Cuerdas tensoras con refuerzo de aramida.
- Exceden las especificaciones de la norma SAE J636c.
(Tipo de producto 8701)



Bandas Timing para árbol de levas

Diseñadas para altos rangos de velocidad constante y requerimientos de potencia para mover el árbol de levas. Cumple o excede los requerimientos de desempeño de los fabricantes de autos en todo el mundo. Aprobadas para aplicaciones marinas. Gates es el fabricante de estas bandas para las mejores marcas Audi, BMW, Chrysler, Fiat, Ford, GM, Honda, Hyundai, Isuzu, Mazda, Mitsubishi, Nissan, Peugeot, Renault, Subaru, Toyota, Volvo, Volkswagen.

- La más amplia cobertura de aplicaciones en el mercado de reemplazo.
- Resistencia, su cubierta patentada es altamente resistente al calor y al aceite.
- La alta resistencia de sus cuerdas tensoras, minimizan su elongación (estiramiento).
(Tipo de producto 8595).



Productos Gates * Características y especificaciones

Bandas Hi-Power® II

Diseñadas para un alto desempeño, secciones disponibles A,B,C,D y E.

Estas han sido las bandas preferidas del mercado por su perfil único y su excelente fabricación.

- Cubierta Flex-Weave® de alta flexibilidad y excelente resistencia al calor, ozono y aceites.
 - Cuerdas Flex-Bonded de alta capacidad de transmisión de potencia y mínimo estiramiento.
 - Paredes curvas y lomo arqueado para una mejor distribución de la fuerza.
 - Su tipo de construcción Multi-propósitos aplica para varios tipos de vehículos.
 - Cumple con las pruebas de conductividad estática de la RMA (Rubber Manufacturer's Association).
 - V80 programa Gates que garantiza el "Hermanaje" de las bandas (de dimensiones iguales).
- (Tipo de producto 9112 Sec. A - 9113 Sec. B).



Bandas Tri-Power®

Bandas dentadas para la transmisión de potencia en poleas en V, en maquinaria industrial y vehículos de servicio pesado. Combina las ventajas de las tradicionales bandas Hi-Power con las de las bandas dentadas.

(Tipo de producto 9012 Sec. AX - 9013 Sec. BX).

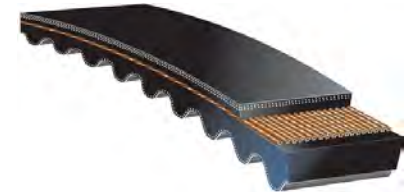

Bandas Vulco®

Banda forrada recomendada para transmitir potencia y movimiento en poleas en V. Ideal para los motores de Volkswagen enfriados por aire, como el del Sedán por sus características especiales de tensado de la banda.

(Tipo de producto 8560).

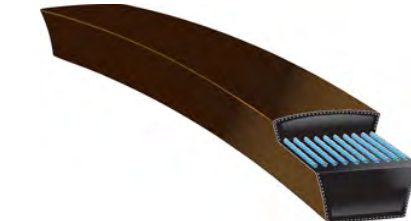

Bandas PowerBand®

Bandas unidas para transmitir potencia en poleas en V para aplicaciones de servicio pesado donde las bandas individuales se voltean por el alto torque en el momento del arranque o durante la aceleración.

(Tipo de producto 8541 Importadas PB, 9091 Nacional PK).

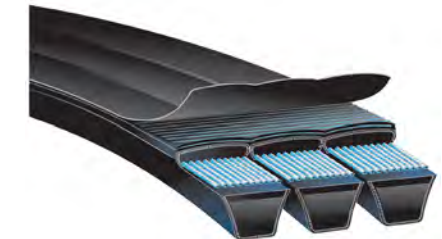

Productos Gates * Características y especificaciones



C5C Manguera Hidráulica SAE 100R5

Recomendada para: Aplicaciones en líneas hidráulicas de media presión de aceite base petróleo en numerosas aplicaciones, aceite lubricante, aplicaciones de aire y agua así como frenos de aire y dirección hidráulica.

(PRECAUCION: Para uso solamente en vehículos comerciales servicio pesado), alimentación de aceites al turbocargador, cilindros inclinados, líneas de transmisiones de refrigerantes y filtración. Las mangueras (-4 hasta -40) cumplen con las especificaciones de SAE 100R5 en aplicaciones hidráulicas tradicionales. Mangueras (-4 hasta -40) DOT FMVSS Tipos A II y SAE J1402 Tipos A II para aplicaciones de frenos de aire (-4 hasta -10) No se recomienda para gasolina ó diesel.

Tubo: -4 y -5: Negro, hule sintético con alta resistencia al aceite y al calor (Neopreno - Tipo A)*, -6 hasta -40: (Nitrilo - Tipo C)*

Refuerzo: Una trenza de alambre de acero al carbón resistente a la tensión sobre una trenza de poliéster.

Cubierta: Negra, una trenza de poliéster resistente al aceite y al enmohecimiento.

Rango de Temperatura: Bajo condiciones SAE 100R5 -40°C a +100°C (-40°F a +212°F) Para aplicaciones en Flotillas (líneas de aceites lubricantes calientes) -40°C a +149°C (-40°F a 300°F) Aire hasta +71°C (+160°F) Para emulsiones de agua, etc. Evitar el uso continuo a temperaturas máximas concurrente con la presión máxima de trabajo.

Conexiones: Conexiones C5 Reusables



C5D Manguera Alta Temperatura (Multifluido)

Recomendada para: Aplicaciones de fluidos a base de petróleo o ésteres fosfatos; Diesel y líneas de filtración, aplicaciones de aire y agua así como frenos de aire, dirección hidráulica **(PRECAUCION:** Para uso solamente en vehículos comerciales servicio pesado), gasolina y provisiones de aceites del turbocargador, en cilindros inclinados, líneas de transmisiones de refrigerantes

y filtración. Las mangueras (-4 hasta -12) cumplen o exceden las especificaciones DOT FMVSS 106-74 Tipo A II y SAE J1402 Tipo A II y SAE J1019 y resistencia a los combustibles en SAE J30R2.

Tubo: Negro, hule sintético con alta resistencia al aceite y el calor (CPE - Tipo J)*

Refuerzo: Una trenza de alambre de acero resistente a la tensión, sobre una trenza de poliéster.

Cubierta: Verde para fácil identificación, una trenza de poliéster resistente al aceite y al enmohecimiento, impregnado con hule sintético.

Rango de Temperatura: -40°C a +149°C (-40°F a +300°F) Para aire solamente +121°C (250°F), el máximo para ésteres fosfatos +100°C (+212°F) Para emulsiones de agua, etc.

Conexiones: Conexiones C5 Reusables



Productos Gates * Características y especificaciones

Manguera Marina C5M (Línea Combustible)

Recomendada para: Aplicaciones de Diesel y gasolina, y líneas de aceite caliente hasta 100°C (212°F) Cumple con los requerimientos de SAE J1527 Tipo A Clase 1 y SAE J1942.

Tubo: Nitrilo - Tipo C*

Refuerzo: Una trenza de alambre.

Cubierta: Azul, Nitrilo Modificado*.

Rango de Temperatura: -20°C a +100°C (-4°F a +212°F)

Conexiones: Acero al carbón ó latón, Conexiones C5 Reusables.

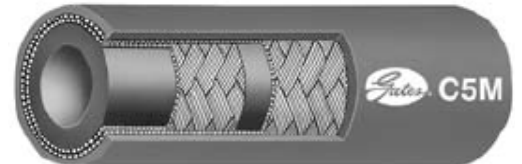

Manguera Flexline C5E de Alta Temperatura

Recomendada Para: Frenos de aire, dirección hidráulica (PRECAUCION: Para uso solamente en vehículos comerciales servicio pesado), filtros de combustibles, líneas refrigerantes de motores y transmisiones, y líneas de aceite lubricantes calientes +149°C (+300°F) No se recomienda para gasolina o Diesel.

Tubo: Negro, hule sintético resistente al aceite y el calor (Nitrilo - Tipo C)*

Refuerzo: Una trenza de alambre de acero de alta tensión sobre una trenza de poliéster.

Cubierta: Negro con una raya verde para fácil identificación. Resistente al aceite y el calor, una trenza de textil impregnado con hule sintético.

Rango de Temperatura: -40°C a +149°C (-40°F a +300°F) Para aire solamente +121°C (250°F) Para emulsiones de agua, etc.

Conexiones : C5E Conexiones Reusables.



Manguera ACR-MegaTech®

Líneas de Retorno para Aire / Aceite Caliente

Recomendada para: Aplicaciones en líneas hidráulicas de retorno de aceite caliente, líneas de compresiones rotarias de aceite/aire.

Tubo: Negro, compuesto especial resistente a alta temperaturas y resistencia química (CPE - Tipo J)*

Refuerzo: Una trenza de alambre de acero de alta tensión.

Cubierta: Una trenza de textil resistente al aceite y al enmohecimiento, impregnado con hule sintético.

Rango de Temperatura: Fluidos a base de petróleo -40°C a +149°C (-40°F a +300°F) Para fluidos de estéres fosfatados por recomendación del fabricante del fluido, entre el rango de -40°C a +100°C (-40°F a 212°F). Para emulsión de agua, etc.

Conexiones: MegaCrimp® hasta -10.

Conexiones GL para -24 y 32.

Conexiones G4H -40 y -48.



Productos Gates * Características y especificaciones



Manguera C14 PTFE

Recomendada para: Descarga de compresor de aire, aceite caliente y fluidos, medio ambientes calientes y grasosos.

Tubo C14: Blanco, no-conductivo - Tipo A, pared suave de Politetrafluoroetileno PTFE*

Tubo C14CT: Blanco/Negro, Tipo B - conductivo, pared suave de PTFE*

Cubierta/Refuerzo: Una trenza de alambre de acero inoxidable Serie 300.

Rango de Temperatura: Dinámica -54°C a +204°C (-65°F a +400°F); Estática: -54°C a +232°C (-65°F a +450°F)

Conexiones: Utilice Conexiones C14.



Calibradores (Medidores) de presión

Recomendados para la medición de presión de aire en las llantas de camiones, tractocamiones y autobuses.

- Rangos de 10- 120 psi y 10-150 psi con incrementos de 2 psi.
- Terminal dual
- Barra de aluminio o Nylon
- Acabado cromado para mayor duración



Infladores-Calibradores

Recomendados para uso en camiones, tractocamiones y autobuses.

- Manguera de extensión en diferentes longitudes, para brindar seguridad.
- Manija de acero cromada, remachada al cuerpo.
- Barra sólida de bronce resistente a la corrosión, calibrada de 10-120 psi, 10-150 psi con incrementos de 2 psi.

Productos Gates * Características y especificaciones

Pistolas para aire y otros fluidos

Recomendadas para trabajos pesados con aire y otras aplicaciones severas.

- De seguridad y estándar
- Puerto de entrada de 1/4 " y salida de 1/8"
- Algunas pueden combinar aire y líquido (venturi) para aplicaciones de limpieza
- Características especiales para diferentes aplicaciones.



tubing de Nylon para Frenos de Aire (TNFA)

Recomendado para Frenos de aire y líneas de servicio en camiones, autobuses y remolques, en donde el calor y los ácidos de la batería no están presentes. Conforme a las especificaciones de SAE J844 y satisface DOT FMVSS-106.

Tubo de Nylon extruido sin costura estabilizado a luz y temperatura. Cubierta de Nylon disponible en Negro, Azul, Verde, Rojo, Amarillo y Naranja. Algunos otros colores se pueden surtir sobre pedido.

Rango de Temperatura: -40°F to 200°F (-40°C to 93°C).

Utilice conexiones Gates DOT Sure-Lok™ (G31) o Gates DOT compresión (G32) y Push In GQ-DOT.

Tipo A - No reforzados en tamaños 1/8", 5/32", 3/16" y 1/4."

Tipo B - Reforzado con una capa de fibra de Nylon en tamaños 5/16", 3/8", 1/2", 5/8" y 3/4."

NOTA: 1/8" y 5/32" no están reconocidos por DOT para sistemas para frenos de aire. Estos son solamente para líneas de servicio.



Ensamblajes para Frenos de aire en espiral

Conecta líneas de aire desde la cabina hasta el remolque.

Las terminales están sujetadas de manera permanente con guardas tipo resorte para mayor duración en servicio.

Cubierta y tubo de Nylon extruido, sin costura y estabilizado con luz y temperatura para resistir las condiciones extremas.

- Reforzado con una capa de fibra de Nylon.
- Satisface requerimientos DOT FMVSS-106.
- Conforme a especificaciones SAE J844.

Rango de temperatura: -40 °F a 200 °F (-40 °C a 93 °C)

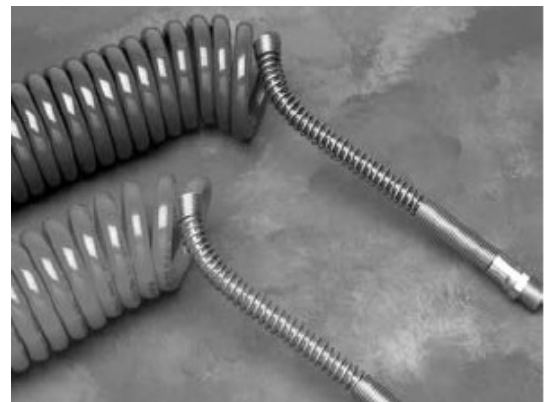

Productos Gates * Características y especificaciones

COMO USAR LOS CONECTORES GQ/GQ-DOT PUSH-IN

Cuando el tubo (1) se inserta en la conexión, primero pasa a través de la grapa de sujeción (2). Justamente debajo de los dientes de la grapa se encuentra el "O" Ring (3), el cual, proporciona un sello a prueba de fugas contra el diámetro exterior del Tubo.

La grapa sujeta a el tubo. Cuando se jala el tubo la grapa se cierra más apretando el tubo debido a la configuración Interna del cuerpo (4).

La parte Inferior del tubo se apoya en la caja del cuerpo (5) evitando de esta forma cualquier fuga.

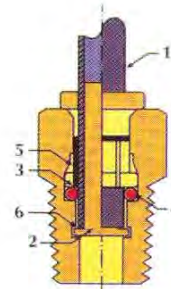

ESPECIFICACIONES Y CARACTERISTICAS DE DISEÑO

- **CONEXION RAPIDA.** Simplemente se empuja el tubo al interior de la conexión, no se requiere de alguna herramienta. Ahorra hasta el 75% del tiempo de montaje de las conexiones estándar de compresión.
- **DESCONEXION RAPIDA.** Sostenga con 2 dedos la conexión y jale el tubo, no se requiere de ninguna herramienta.
- **REUSABLE.** Conecte y desconecte cualquier número de veces.
- **DISEÑO DE FLUJO TOTAL.** Proporciona hasta un 60% más de área de flujo que las conexiones convencionales con soportes Internos.
- **SELLO POSITIVO.** No existen fugas después de que el tubo se ha insertado; el sello está hecho.
- **VERSATIL.** "O" Rings de material BUNA-N.
- **RETENCION SEGURA DEL TUBO.** Jalando el tubo se lleva a acabo el apriete con la conexión.
- **CONJUNTO EN UNA SOLA PIEZA.** No se extravían partes tales como cuerpo e inserto.
- **LINEA COMPLETA.** De estilos y tamaños.
- **CONSTRUCCION DE LATON.** Codos y Tees son de latón forjado.
- **FACILIDAD DE ESCOGER.** Tees y Codos, ya sea tipo económico estacionario o tipo giratorio.
- **TEFLON PRE-APLICADO.** En todas las cuerdas macho para tubería, ahorrándole al usuario trabajo adicional.
- **PRESION DE TRABAJO.** Se recomienda utilizar la conexión hasta la máxima presión de trabajo del tubo de plástico utilizado.
- **TEMPERATURA DE TRABAJO.** Desde -23°C hasta 93.3°C (Se dispone de rangos mayores si se requiere).
- **CUERDA PARA TUBO.** Con teflón pre-aplicado.



PARA CONECTAR EL TUBO

- Corte el tubo a escuadra como sea posible.
- Inserte el tubo en la conexión, hasta que sienta que el tubo pasa a través del "O" Ring.
- Aplicar un movimiento ligero de giro mientras inserta el tubo, es de mucha ayuda.
- Después de haber sentido que se cruza el "O" Ring, se continua empujando el tubo hasta llegar al tope en la parte Inferior de la conexión.



PARA DESCONECTAR EL TUBO

- Con el dedo pulgar y el indice mantenga abajo la parte superior del Inserto contra el cuerpo de la conexión, luego con la otra mano jale el tubo.
- No se requieren herramientas.

Herramientas:



Alineador Láser DriveAlign™

(No. De Parte 91006)

Identifica rápidamente los dos tipos de desalineación de las poleas más comunes – desalineación angular y horizontal -, los cuales reducen la vida de servicio de los componentes y produce ruido en las transmisiones de las bandas, simplemente con colocar el alineador en las ranuras de la polea y apuntar el láser a la polea opuesta. Cualquier desalineación será visible en un instante.

- Esta herramienta patentada es compatible con todas las transmisiones que utilicen bandas serpentin.
- Ligera y fácil de usar.
- Incluye lentes especiales que amplifican el láser para mejorar la visión en condiciones de baja iluminación.
- Incluye un estuche durable de alto impacto.

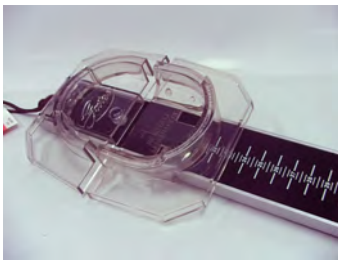

Medidor Banda Micro-V®

(No. De Parte 91202)

Esta herramienta mide todas las bandas Micro-V de sección "K". Útil para determinar la numeración de una banda cuando se tiene una muestra.

- Se puede medir bandas desde 36" hasta 120". (Cerrado mide solamente 3 pies.)
- Ligero, exacto, y fácil de usar.



Localizador Banda-V

(No. De Parte 91201)

Esta herramienta ayuda a identificar el tipo de banda en V que se requiere.

- Identifica el ancho superior de la banda
- Identifica el tipo y longitud de la banda.
- Ligero, exacto y fácil de usar.



Herramienta para tensar las bandas de Serpentin

(No. Part. 91015)

Herramienta ideal para quitar e instalar las bandas de serpentin. Proporciona la fuerza necesaria para desplazar el brazo de la polea tensora.

- El nuevo diseño de 3 barras incluye siete adaptadores (13m m, 14m m, 15m m, 16m m, 18m m, 3/8 " y el 1/2 ").



Productos Gates * Características y especificaciones

Gates continúa marcando el camino en Innovación y solución de problemas



ECR[®]
ELECTROCHEMICAL
RESISTANT

Gates se ha mantenido en la cima en Innovación y solución de problemas, poniendo a nuestros clientes en clara ventaja sobre la competencia.

A mediados de los 80's, la mayoría de los problemas de las mangueras de enfriamiento, se atribuían al calor, al refuerzo y a las bajas temperaturas.

Los Ingenieros de Gates descubrieron que la mayoría de estos problemas son el resultado del ataque electroquímico sobre el tubo de la manguera. Diferentes tipos de metales en el sistema de refrigeración, por ejemplo un bloque de hierro fundido, un calentador de aluminio y un núcleo central de cobre del radiador, generan una carga eléctrica. Esta carga se transmite entre los metales y el refrigerante dentro de la manguera.

Debido a esta carga generada, diminutas grietas aparecen en el tubo de la manguera. El refrigerante se filtra a través de estas grietas, penetra el refuerzo y termina por romper la cubierta. Gates denomina a esta causa y efecto, Degradación Electroquímica.

Gates desarrolló un nuevo compuesto de hule que evita esta falla y lo podrá distinguir mediante las siglas ECR en las etiquetas de nuestras mangueras. ECR significa mayor tiempo de vida útil y un servicio más confiable.



Mangueras de Enfriamiento

Mangueras Curvas

Mangueras moldeadas para satisfacer aplicaciones específicas. Idénticas a las de Equipo Original. Aprobadas para aplicaciones marinas.

- Recomendado para el sistema de enfriamiento: superior, inferior, by-pass, calefacción y otras aplicaciones.
- Cubierta resistente al calor y al ozono.
- Diseñado para resistir la degradación electroquímica - principal falla de una manguera de enfriamiento.
- Materiales rediseñados para resistir vacío. Esto reduce la necesidad de resortes internos
- Cumple con SAE 20R4 y 20R3 Tipo CE Clase D-1 y D-2
- Rango de Temperatura: -40°C a 135°C

PRECAUCIÓN: No utilizar para transferir combustible o aceite.

RECOMENDACIÓN: Siempre reemplace el juego de mangueras, superior e inferior, esto garantizará el óptimo desempeño del sistema de enfriamiento

Nomenclatura CH nacionales:

Las letras "CH" indican que se trata de una manguera curva

Las siguientes 2 cifras indican la armadora, de la siguiente manera:

- 10 Agromack
- 11 Chrysler, Dodge, Jeep
- 12 DINA
- 13 Ford, Lincoln, Mercury
- 14 General Motors
- 17 Mercedes Benz
- 18 Nissan
- 20 Renault
- 21 VAM
- 22 Volkswagen

Las siguientes 3 cifras indican un consecutivo pro armadora, mismo que se debe llevar en un registro.

La última cifra indica la posición de la manguera en el vehículo.

- 1 Superior
- 2 Inferior
- 3 Paso
- 4 Calefacción
- 5 Superior, inferior
- 6 Gasolina
- 7 Drenado
- 8 Frenos





MASTER SERVICIO PESADO 2014

Productos Gates * Características y especificaciones

Mangueras de Enfriamiento (Continúa).



Mangueras Twister GS

Diseñada para reemplazar mangueras de enfriamiento rectas o curvas.

Uno de sus beneficios es su cobertura, pues con un mínimo de inventario se cubre un gran número de aplicaciones.

- Excelente flexibilidad, sin riesgo de colapso y/o torsión
- Refuerzo de Rayón de alta tenacidad y alambre helicoidal galvanizado
- Tubo y cubierta de EPDM, de gran resistencia al calor, prolongando la vida útil de la manguera
- Cumple SAE J20R5

Rango de temperaturas: -40°C hasta +125 ° C

Presión máxima de 40 psi.

PRECAUCIÓN: No utilizar para transferir combustible o aceite

Nomenclatura

Los primeros dos dígitos indican el D.I. de la manguera en ambas terminales, en caso de tener diámetros diferentes, el segundo diámetro es indicado mediante un tercer y hasta un cuarto dígito antes de la T.

12: 1 ¼", 15: 1 ½" 17: 1 ¾" 2: 2" 22: 2 ¼" 25: 2 ½"
27: 2 ¾" 30: 3"

T: Manguera Twister

Los últimos tres dígitos indican la longitud en décimos de pulgada.

GS: Servicio Pesado

17T110GS

12 : Tiene 2 dígitos, por tanto es de diámetros iguales D.I. de 1 1/4"

T : Manguera Twister,
150 : 15.0" de Longitud

Los últimos tres dígitos indican la longitud en décimos de pulgada.

172T190GS

172 : Tiene 3 dígitos, por tanto es de diámetros diferentes D1: 17= 1 3/4", D2 : 2=2"

T : Manguera Twister,
190 : 19.5" de Longitud
GS : Servicio Pesado

TWISTER®	φ 1	φ 2	Longitud
GS505 - 172T190 GS	1 ¼	2	19.0
GS506 - 172T235 GS	1 ¼	2	23.5
GS526 - 2225T180 GS	2 ¼	2 ½	18.0
GS528 - 2225T250 GS	2 ¼	2 ½	25.0
GS515 - 222T150 GS	2	2 ¼	15.0
GS516 - 222T175 GS	2	2 ¼	17.5
GS517 - 222T250 GS	2	2 ¼	25.0
GS518 - 225T200 GS	2	2 ½	20.0
GS603 - 17T110 GS	1 ¼		11.0
GS501 - 17T135 GS	1 ¼		13.5
GS508 - 20T122 GS	2		12.2
GS507 - 20T95 GS	2		9.5
GS520 - 22T110 GS	2 ¼		11.0
GS521 - 22T140 GS	2 ¼		14.0
GS523 - 22T190 GS	2 ¼		19.0
GS524 - 22T240 GS	2 ¼		24.0
GS252 - 22T270 GS	2 ¼		27.0
GS519 - 22T90 GS	2 ½		9.0
GS530 - 25T140 GS	2 ½		14.0
GS531 - 25T160 GS	2 ½		16.0
GS532 - 25T240 GS	2 ½		24.0
GS533 - 25T280 GS	2 ½		28.0
GS536 - 27T180 GS	2 ¾		18.0
GS509 - 20T145 GS	2		14.5
GS513 - 20T330 GS	2		33.0
GS538 - 30T370 GS	3		37.0



Productos Gates * Características y especificaciones

Mangueras de Enfriamiento (Continúa).



Manguera Charter®

- Manguera para radiador envuelta.
- Tubo interno: EPDM.
- Refuerzo: Lona fricciónada con hule.
- Cubierta vendada: EPDM resistente al calor, ozono, refrigerante, abrasión y al ambiente grasoso del cofre.
- Cumple con la norma SAE J20 R4.

Mayor duración:

- Reforzada con lona fricciónada con hule envolvente que le da una extraordinaria resistencia.
- Hules de alta resistencia al calor, ozono y abrasión.
- Resistente al ambiente del motor.

D.I. (pulg.)	P.T. (psi)
1/2	43
3/4	40
1	38
1 1/4	35
1 1/2	33
1 3/4	30
2	28

D.I. (pulg.)	P.T. (psi)
2 1/4	25
2 1/2	22
2 3/4	20
3	17
3 1/4	16
3 1/2	15
4	13



Manguera Durion® para Radiador

- Manguera recta de Silicón tipo envuelta para el sistema de enfriamiento
- Tubo interno y cubierta : Silicón
- Refuerzo: Una capa interna de Aramida tejida.
- Cumple con la norma SAE J20 R1
- Resistencia a temperaturas extremas -57°C a 177°C (-70°F a 350°F)..

Número Parte	D.I. (pulg.)	P.T. (psi)
24808	1/2	110
24810	5/8	110
24812	3/4	110
24814	7/8	110
24816	1	90
24818	1 1/8	90
24820	1 1/4	85
24822	1 3/8	85
24824	1 1/2	85
24826	1 5/8	80
24828	1 3/4	80

Número Parte	D.I. (pulg.)	P.T. (psi)
24836	2 1/4	75
24838	2 3/8	65
24840	2 1/2	65
24844	2 3/4	50
24848	3	50
24850	3 1/8	40
24852	3 1/4	40
24856	3 1/2	35
24860	3 3/4	35
24864	4	35
24872	4 1/2	25

Productos Gates * Características y especificaciones

Mangueras de Enfriamiento (Continúa).



Manguera Durion® para Calefacción

- Manguera recta de Silicón tipo envuelta para el sistema de enfriamiento
- Tubo interno y cubierta : Silicón
- Refuerzo: Una capa interna de Aramida tejida.
- Cumple con la norma SAE J20 R3
- Resistencia a temperaturas extremas -57°C a 204°C.

Número Parte	D.I. (pulg.)	P.T. (psi)	Longitud metros	P.T. (psi)
26239	3/8	60	7.62	60
26240	1/2	60	7.62	60
26241	5/8	60	7.62	60
26242	3/4	50	7.62	50
26244	1	45	7.62	45



Conector Vibraflex

- Manguera moldeada tipo vendada.
- Tubo interno: Nitrilo resistente al aceite y vapores de combustible.
- Refuerzo: Dos capas de textil sintético.
- Cubierta: Neopreno resistente al calor, al ozono, vapores de aceite, abrasión y combustible
- Cumple con la norma SAE J20 (Clase B para el Tubo y Clase C para la cubierta)
- Temperatura máxima de operación: 100°C.

Número Parte	D.I. (pulg)	Longitud (pulg)	P.T. (psi)
23505	1 1/4	4	70
23511	1 3/8	5	60
23515	1 1/2	5	60
23520	1 3/4	5	55
23531	2	3 1/2	50
23533	2	5	50
23547	2 1/4	4 1/2	40
23557	2 3/8	5	35
23559	2 3/8	6 1/4	35
23562	2 1/2	4 1/2	35

Número Parte	D.I. (pulg)	Longitud (pulg)	P.T. (psi)
23550	2 1/2	6	35
23566	2 3/4	3 1/4	30
23567	2 3/4	4 1/2	30
23568	2 3/4	5 3/8	30
23572	3	4	25
23575	3	7	25
23585	3 1/2	5 1/2	25
23002	4	5	25
23004	5	6	25
23005	5 1/2	6	25

Productos Gates * Características y especificaciones

Mangueras de Combustible

Manguera FLH



Es la manguera más utilizada como línea de combustible para motores a gasolina

- Tubo de Nitrilo resistente a los combustibles
- Cubierta resistente a derivados del petróleo, el calor, el ozono y a la abrasión.
- Cumple con la norma SAE 30R2.
- Rango de Temperatura: -20°C a 93°C
- NOTA: No sumergirse en gasolina.

Número	Diámetro interior (pulg.)	Presión de trabajo (psi)	Presión de ruptura (psi)	Presentación mini carretes (metros)	Presentación carrete madera (metros)
2FLH	1/8	50	700	35	325
3FLH	3/16	150	700	25	250
4FLH	1/4	125	700	20	200
5FLH	5/16	150	700	14	200
6FLH	3/8	115	700	14	120

Manguera FLC



Diseñada para la conducción de gasolina, diesel o aceite a presión moderada que requiere un refuerzo adicional

- Cubierta de textil tratado químicamente para darle una mayor resistencia al ambiente (humedad, calor, etc)
- Rango de Temperatura: -20°C a 93°C
- Presión de trabajo de 200 psi en todos sus tamaños.
- NOTA: No sumergirse en gasolina.

Número	Diámetro interior (pulg.)	Presión de trabajo (psi)	Presión de ruptura (psi)	Presentación mini carretes (metros)	Presentación carrete madera (metros)
2FLC	1/8	200	700	35	120
3FLC	3/16	200	700	25	151
4FLC	1/4	200	700	20	131
5FLC	5/16	200	700	20	137
6FLC	3/8	200	700	15	145

Manguera MPI / Fuel Injection

Es la manguera Premium para la conducción de combustible, incluyendo sistemas de inyección.

Se puede utilizar en gasolinas con plomo y sin plomo, diesel, biocombustibles a base de etanol/ metanol, éteres con concentraciones no mayores a las permitidas por EPA

- Tubo interno de Fluorelastómero resistente a los combustibles, al calor y a la permeación.
- Refuerzo de poliéster trenzado, dando una mayor resistencia.
- Cubierta resistente a derivados del petróleo, el calor, el ozono y a la abrasión.
- Cumple con la norma SAE 30R9.
- Temperatura máxima de 150°C
- NOTA: No sumergirse en gasolina.



NÚMERO DE PARTE (3.05 mts)	NÚMERO DE PARTE (7.62 mts)	DIAMETRO INTERIOR (plg)	PRESION DE TRABAJO (psi)
27082	27094	1 / 4	180
27085	27095	5 / 16	180
27088	27096	3 / 8	180

Productos Gates * Características y especificaciones

Mangueras de Combustible (Cont.)

Manguera Sumergible



Las mangueras convencionales de combustible, son resistentes únicamente para tener contacto con el tubo de la manguera. La manguera sumergible de Gates, supera la calificación y es resistente a la gasolina, al alcohol o al diesel, tanto en el tubo como en la cubierta, por lo que puede sumergirse en cualquiera de estos combustibles sin ningún riesgo de degradación, lo que provocaría taponamientos en la bomba de combustible.

- Diseñado para un contacto permanente con la gasolina (y otros combustibles) en el interior y el exterior.
- Excelente para uso en bombas de combustible en el tanque de gasolina.
- Cumple con la norma SAE 30R10.
- Tubo de Fluoroelastómero (FKM) resistente a permeación y retarda el envejecimiento.
- Refuerzo de Aramida, la misma fibra utilizada en los chalecos antibalas.

No. Parte	Diámetro Int.	Presión trabajo	Presión (Burst)	Longitud
27093	5/16"	100 psi	500 psi	30.480 cm
27097	3/8"	100 psi	500 psi	30.480 cm

Manguera Fuel Fill



Manguera flexible diseñada para el llenado del tanque de combustible. Se puede utilizar tanto en servicio automotriz como en servicio pesado.

Compatible con la mayoría de los tipos de combustibles, especialmente resistente a la gasolina y al diesel.

- Tubo de nitrilo resistente a gasolina, mezclas de etanol, metanol y éteres hasta concentraciones máximas permitidas por la EPA
 - Cubierta corrugada con refuerzo de alambre helicoidal.
 - Cumple con la norma SAE 30R5.
 - Se corta fácilmente con cuchillo y cortadoras de alambre.
- Rango de temperatura: -40°C a 100°C

No. Parte	Diam. Int. (Pulgadas)	Presión de Trabajo
23924	1 1/2	20
23930	1 7/8	20

No. Parte	Diam. Int. (Pulgadas)	Presión de Trabajo
23932	2	20
23936	2 1/4	20
23940	2 1/2	20

Manguera Filler Neck



Manguera recta diseñada para el llenado del tanque de combustible.

- Tubo de nitrilo resistente a gasolina, mezclas de etanol, metanol y éteres hasta concentraciones máximas permitidas por la EPA.
- Cubierta lisa.
- Cumple con la norma SAE 30R6.
- Rango de temperatura: -40°C a 100°C

No. Parte	Diam. Int. (Pulgadas)	Presión de Trabajo
23964	1 1/2	20
23968	1 3/4	20

No. Parte	Diam. Int. (Pulgadas)	Presión de Trabajo
23972	2	20
23976	2 1/4	20
23980	2 1/2	20

Mangueras de Calefacción



Manguera 30T

Recomendada para usarse en el sistema de calefacción y/o enfriamiento.

Reforzada con una capa de textil tejido, que le da mayor resistencia a la presión, hasta 175 psi y mayor flexibilidad en radios menores

Temperatura máxima de 125°C

Tubo y cubierta de EPDM, evitando la penetración de aceites y grasas.

Diámetros disponibles 5/8" y 3/4"

Productos Gates * Características y especificaciones

Mangueras de Ventilación



Manguera ADS2

- Manguera flexible de hule para calefacción, ventilación, paso y/o succión de aire, vapores de agua y humos de combustión
- Gran variedad de diámetros desde 7/8" hasta 12"
- Soporta temperaturas de -18°C a 70°C (0°F a 158°F) sin sufrir alteraciones
- Presión de descarga de 7.1 psi y de vacío de 760 mmHg
- Tubo interno: Nitrilo resistente a combustibles como gasolina, diesel y aceite.
- Refuerzo: Una capa de textil y alambre en espiral interconstruido.
- Cubierta: Textil friccionado con hule natural color negro



Manguera para Turbocargador Recta sin anillos

- Manguera de Silicón envuelta.
- Reforzada con textil de fibra de vidrio y cuerpo de silicón naranja
- Soporta temperaturas de -40°C a 205°C (-40°F a 400°F)

Número Parte	D.I. (pulg)	Longitud (pulg)	P.T. (psi)
26116	1	36	45
26124	1 ½	36	40
26128	1 ¾	36	35
26132	2	36	35
26136	2 ¼	36	30
26138	2 3/8	36	30
26140	2 ½	36	30
26142	2 5/8	36	15
26144	2 ¾	36	25
26001	3	3	25
26148	3	36	25

Número Parte	D.I. (pulg)	Longitud (pulg)	P.T. (psi)
26002	3 3/8	3 1/2	15
26003	3 3/8	6	15
26154	3 3/8	36	15
26004	3 1/2	3	20
26156	3 1/2	36	20
26160	3 3/4	36	15
26162	3 7/8	36	15
26164	4	36	15
26166	4 1/2	36	15
26007	5	3 1/2	15
26008	5 1/2	3 1/2	15



Manguera para Turbocargador con anillos

- Manguera de Silicón con anillos
- Tubo: Silicón color naranja
- Refuerzo: Una capa interna de Aramida
- Cubierta: Cuatro capas de Silicón con 3 ó 4 anillos
- Soporta temperaturas de -51°C a 260°C (-60°F a 500°F)

Número Parte	D.I. (pulg)	Longitud (pulg)	P.T. (psi)
26200	3	6	110
26201	3 1/2	6	110
26203	4	6	110
26204	4	8	110

Mangueras de Ventilación (Continúa)

Conectores para aire

Recomendados para usarse en aplicaciones de servicio pesado para conducción de aire filtrado, calefacción, ventilación e inclusive succión de vapores tanto de agua como de combustible o humos, donde se requiera absorber y/o corregir problemas de alineación.

Conector recto con joroba



Número Parte	D.I. (pulg)	Longitud (pulg)
23002	4	5
23004	5	6
23005	5 1/2	6
23006	6	5

Conector recto flexible



Número Parte	D.I. (pulg)	Longitud (pulg)
23400	4	22
23402	6 1/8	19

Conector reductor recto con joroba



Número Parte	D.I. 1 (pulg)	D.I. 2 (pulg)	Longitud (pulg)
23002	3 1/2	3	5 1/4
23004	4	3	5 1/4
23005	6	5 1/2	6
23006	7	6	5

Codos moldeados



Número Parte	D.I. (pulg)	Longitud (pulg)	Ángulo °	Con Costillas
23201	3	5 1/4	90°	Si
23202	3 1/2	5 1/2	45°	No
23203	3 1/2	5 1/2	90°	Si
23208	5	5 1/4	45°	No
23209	5	6	90°	No
23215	6	6 1/2	45°	Si
23216	6	7 1/2	54°	Si
23218	6	7	90°	Si
23221	7	7 1/2	90°	No

Codos reductores moldeados



Número Parte	D.I. 1 (pulg)	D.I. 2 (pulg)	Longitud (pulg)	Ángulo °	Con Costillas
23300	6	5 1/2	6	90°	No

Productos Gates * Características y especificaciones

Manguera de limpiaparabrisas



Manguera 4106

Diseñada para la conducción de agua o líquido limpiador de cristales, desde el depósito hasta los limpiadores.

- Tubo de EPDM extraído, apropiado para conducir agua y soluciones ligeras
- Cubierta lisa de EPDM, brindando mayor resistencia al medio ambiente
- Presentación: mini carrete de 3/16" D.I. X 30 metros aprox.

Reductores de diámetro



Son adaptadores que se deslizan fácilmente dentro de las mangueras Gates para reducir el diámetro interior.

- Gran cobertura de Diámetros con un mínimo de inventario de mangueras
- Capacidad de ajustar el D.I. de una manguera mayor en reemplazos de emergencia

CÓDIGO	DESCRIPCIÓN	MEDIDAS
77369390	26390 HOSE ID REDUCER	1 1/2" a 1 1/4"
77369391	26391 HOSE ID REDUCER	1 3/4" a 1 1/2"
77369392	26392 HOSE ID REDUCER	2" a 1 3/4"
77369393	26393 HOSE ID REDUCER	2 1/4" a 2"
77369394	26394 HOSE ID REDUCER	2 1/2" a 2 1/4"
77369395	26395 HOSE ID REDUCER	3" a 2 1/2"

Precaución: Recomendados exclusivamente para aplicaciones de aire y de enfriamiento.

Diafragmas

Recomendada para: Autobuses, camiones y vehículos de servicio pesado, como elemento de seguridad y alto desempeño



- Exceden el **millón de ciclos estipulado por la norma SAEJ1450**
- Han sido diseñados y construidos para adecuarse a las rudas condiciones de operación de las cámaras de frenos ("rotochambers") nuevas y reconstruidas

Número Parte	D.E. (pulg)	Área de trabajo (pulg ²)
Diafragma 9	5	9
Diafragma 12	5 1/2	12
Diafragma 16	6	16
Diafragma 20	6 1/2	20
Diafragma 24	7	24
Diafragma 30	8	30
Diafragma 30P	8 1/2	30

Productos Gates * Características y especificaciones

Cintas Antiestáticas



Recomendada para usarse en camiones, pipas y carros tanque que transportan combustibles o materiales inflamables

Fabricadas con hule especialmente compuesto para conducir la electricidad estática, resistente a la abrasión, ambiente, y desgarre.

Número Parte	Longitud (pulg)	Ancho (pulg ²)	Espesor (pulg)
90330	25	1 1/16	3/16
90331	30	1 1/16	3/16

Unicoil



Ahora sus clientes pueden hacer sus propias mangueras curvas, utilizando 30T, 35B o manguera de calefacción y el nuevo patentado Unicoil™

Unicoil es perfecto para sustituir mangueras de motores adaptados, así como para resolver problemas de ruteo.

- No se necesitan herramientas o equipos especiales.
 - Ideal para mangueras de modificados o adaptados.
 - Evita el colapsamiento de las mangueras que son sometidas a dobleces pronunciados.
 - Solución perfecta cuando la manguera moldeada no está disponible.
 - Puede ser adquirido de forma individual o en una caja de 12, con display incluido
- Disponible en: 1/4", 5/16", 3/8", 1/2", 3/4", 5/8" y 1"

CÓDIGO	DESCRIPCIÓN	PRESENTACIÓN
73162000	28510 Unicoil 1/2"	Caja con 12 pzas
73162001	28511 Unicoil 5/8"	Caja con 12 pzas
73162002	28512 Unicoil 3/4"	Caja con 12 pzas
73162003	28513 Exhibidor	Exhibidor con 12 cajas: 3 de 1/2", 6 de 5/8" y 3 de 3/4"
73162005	28514 Unicoil 1/4"	Caja con 12 pzas
73162006	28515 Unicoil 5/16"	Caja con 12 pzas
73162007	28516 Unicoil 3/8"	Caja con 12 pzas
73162008	28517 Unicoil 1"	Caja con 6 pzas
73162004	28518 Exhibidor	Exhibidor con 18 cajas: de 1/4", de 5/16" y de 3/8"



Productos Gates * Características y especificaciones

Manguera de Enfriamiento del Aceite de Transmisión



Tubo de nitrilo resistente al aceite
Temperatura Máxima de Operación: 150°C (300°F)
Disponible en tres longitudes: 3, 25 y 50 pies
Excede la norma SAEJ1019

D.I. (pulg)	P.T. (psi)	Número Parte 3 pies	Número Parte 3 pies	Número Parte 3 pies
5/16	400	27056	27058	27060
3/8	400	27057	27059	27061
1/2	400	27065	27066	27067



Manguera RECTA de Silicón

RECTAS



Descripción	DI	Longitud	Capas
SIH037363C	3/8"	36"	3
SIH050363C	1/2"	36"	3
SIH063363C	5/8"	36"	3
SIH075363C	3/4"	36"	3
SIH100363C	1"	36"	3
SIH125363C	1 1/4"	36"	3
SIH150363C	1 1/2"	36"	3
SIH175363C	1 3/4"	36"	3
SIH200363C	2"	36"	3
SIH250363C	2 1/2"	36"	3
SIH275363C	2 3/4"	36"	3
SIH300363C	3"	36"	3
SIH350363C	3 1/2"	36"	3
SIH400363C	4"	36"	3
SIH450363C	4 1/2"	36"	3
SIH500363C	5"	36"	3
SIH550363C	5 1/2"	36"	3
SIH600363C	6"	36"	3
SIH800363C	8"	36"	3

- * Reforzadas con 3 y 4 capas de Poliéster
- * Resistentes a temperaturas extremas -60° C a + 180° C
- * Excede los requerimientos de la norma SAE J20 R1 CLASE A
- * Resistentes al ozono y rayos UV
- * Acabado brillante que da una mayor resistencia a las partículas de aceite y combustibles en el exterior de la manguera.
- * Formula exclusiva Silicón diseñada para una excelente compatibilidad química con los refrigerantes de nueva generación.



CODOS de Silicón 45° Y 90°

CODOS

Descripción	DI	Capas	Grados
SIH100123C90	1"	3	90
SIH150123C90	1 1/2"	3	90
SIH175123C90	1 3/4"	3	90
SIH200124C90	2"	4	90
SIH200125C90	2"	5	90
SIH225124C90	2 1/4"	4	90
SIH225125C90	2 1/4"	5	90
SIH250124C90	2 1/2"	4	90
SIH250125C90	2 1/2"	5	90
SIH275123C90	2 3/4"	3	90
SIH275124C90	2 3/4"	4	90
SIH3000084C90	3"	4	90
SIH300124C90	3"	4	90
SIH300125C90	3"	5	90
SIH350123C90	3 1/2"	3	90
SIH350124C90	3 1/2"	4	90
SIH400124C90	4"	4	90
SIH400125C90	4"	5	90
SIH400145C90	4"	5	90
SIH300064C45	3"	4	45
SIH400063C45	4"	3	45
SIH400065C45	4"	5	45
SIH400124C45	4"	4	45
SIH400125C45	4"	5	45



- Reforzadas con 3, 4 y 5 capas de Poliéster
- Resistentes a temperaturas extremas -60° C a + 180° C
- Excede los requerimientos de la norma SAE J20 R1 Clase A
- Resistentes al ozono y rayos UV
- Acabado brillante que da una mayor resistencia a las partículas de aceite y combustibles en el exterior de la manguera.

TURBO cargador con anillos



Descripción	DI	Longitud	Anillos
SIH61/710136MM2A	2.4" x 2.8"	5.35"	2
SIH890133MM2A	3.5"	5.24"	2
SIH400063A	4"	6"	3
SIH400083A	4"	8"	3
SIH620160MM3A	2.44"	6.3"	3
SIH700170MM4A	2.76"	6.69"	4
SIH2750085A	2 3/4"	8"	5
SIH80/1000225MM5A	3.15" x 3.94"	8.86"	5
SIH80/840215MM5A	3.15" x 3.31"	8.46"	5
SIH3500856A	3 1/2"	8 1/2"	6
SIH400096A	4"	9"	6
SIH890215MM6A	3.5"	8.46"	6
SIH4001257A	4"	12 1/2"	7
SIH8903057A	3.5"	12"	7

- Reforzadas con 4 capas de Kevlar (Aramida)
- Resistentes a temperaturas extremas -60° C a + 232° C
- Excede los requerimientos de la norma SAE J20 R3 Clase A
- Resistentes al ozono y rayos UV
- Anillos de acero inoxidable grado 316 que evitan el inflamamiento de la manguera.
- Recomendadas para la entrada y salida en los sistemas de Turbocargador
- Excelente flexibilidad, capaz de soportar altas vibraciones

Manguera para Calefacción de silicón

CALEFACCIÓN



Descripción	DI	Longitud
26239 3/8" X 25 ft	3/8"	25 ft / 7.62 m
26240 1/2" X 25 ft	1/2"	25 ft / 7.62 m
26241 5/8" X 25 ft	5/8"	25 ft / 7.62 m
26242 3/4" X 25 ft	3/4"	25 ft / 7.62 m
26244 1" X 25 ft	1"	25 ft / 7.62 m
26238 DURION HH 1/4 X 250 ft	1/4"	250 ft / 76.2 m
26239 DURION HH 3/8 X 250 ft	3/8"	250 ft / 76.2 m
26240 DURION HH 1/2 X 250 ft	1/2"	250 ft / 76.2 m
26241 DURION HH 5/8 X 250 ft	5/8"	250 ft / 76.2 m
26242 DURION HH 3/4 X 250 ft	3/4"	250 ft / 76.2 m
26244 DURION HH 1 X 250 ft	1"	250 ft / 76.2 m
26247 DURION HH 1 1/4 X 250 ft	1 1/4"	250 ft / 76.2 m

*Carretes y tramos continuos

- Reforzada con 1 tramado de Poliéster
- Resistentes a temperaturas extremas -60° C a + 180° C
- Excede los requerimientos de la norma SAE J20 R3 Clase A
- Gran resistencia a: envejecimiento, ozono, rayos UV y craqueo.
- Excelente flexibilidad
- Formula exclusiva Silicón diseñada para una excelente compatibilidad química con los refrigerantes de nueva generación.



Aplicaciones Especiales

Mangueras para tractores agrícolas



CH-101002
1 1/2 X 17 3/4

CH-101002
Manguera Inferior
Massey Ferguson
Modelo 285



CH-101062
1 15/16 X 12 1/2

CH-101062
Manguera Inferior
Massey Ferguson
Modelo 1105



CH-101034
2 1/4 X 22 1/2

CH-101034
Manguera de Paso
Massey Ferguson
Modelo 265



CH-101074

CH-101074
Manguera de Paso
Massey Ferguson
Modelo: 265, 285



CH-101041
1 1/2 X 13

CH-101041
Manguera Superior
Massey Ferguson
Modelos: 50, 185,
205, 285



CH-101081

CH-101081
Manguera Superior
Massey Ferguson
Modelo 65



Guía de Poleas DriveAlign®

Listado por número de parte

No. De Parte	Material	Diámetro Exterior	Diámetro del buje	Ancho	Tipo de banda	Superficie de la polea
36026	Acero	70mm	12mm	30mm	6 costillas K	V-Ranurada
T36038	Termoplástico	80mm	8mm	30.3mm	6 costillas K	V-Ranurada
36060	Termoplástico	80mm	24mm*	29mm	3/8 V – SAE 10A	V-Ranurada
36086	Acero	84mm	12mm	25mm	6 costillas K	Lisa
36087	Acero	78mm	12mm	20mm	5 Costillas K	Lisa
36091	Acero	74mm	17mm	39.25mm	10 Costillas K	Lisa
36092	Acero	74mm	17mm	46.25mm	12 Costillas K	Lisa
36093	Acero	72.5mm	17mm	38mm	8 Costillas K	V-Ranurada
36094	Termoplástico	78mm	17mm	32.8mm	8 Costillas K	Lisa
36095	Acero	74mm	17mm	32.8mm	8 Costillas K	Lisa
36096	Acero	86.5mm	17mm	39.4mm	10 Costillas K	Lisa
36097	Acero	119mm	17mm	38mm	8 Costillas K	V-Ranurada
36098	Termoplástico	72mm	17mm	39mm	10 Costillas K	V-Ranurada
36099	Acero	70mm	15mm	20.5mm	4 Costillas K	V-Ranurada
36100	Acero	76mm	17mm	29.5mm	6 Costillas K	V-Ranurada
36101	Acero	70mm	17mm	31mm	6 Costillas K	Lisa
36102	Termoplástico	90mm	17mm	32mm	7 Costillas K	V-Ranurada
36103	Acero	107mm	12mm	32mm	3/8 V – SAE 10A	V-Ranurada
38001	Acero	90mm	17mm	30mm	6 Costillas K	Lisa
38002	Acero	100mm	17mm	30.5mm	6 Costillas K	Lisa
38003	Acero	94.5mm	12mm	16.5mm	3/8 V – SAE 10A	V-Ranurada
38004	Acero	118mm	12mm	16.5mm	3/8 V – SAE 10A	V-Ranurada
38005	Acero	82mm	17mm	30.5mm	6 Costillas K	Lisa
38006	Acero	76mm	17mm	30.5mm	6 Costillas K	Lisa
38007	Termoplástico	90mm	17mm	25.5mm	6 Costillas K	Lisa
38008	Termoplástico	70mm	17mm	34.5mm	6 Costillas K	V-Ranurada
38009	Termoplástico	76mm	17mm	25mm	6 Costillas K	V-Ranurada
38010	Acero	90mm	17mm	27mm	5 Costillas K	Lisa
38011	Acero	82mm	17mm	27mm	5 Costillas K	Lisa
38012	Termoplástico	90mm	17mm	32mm	6 Costillas K	Lisa
38015	Termoplástico	76mm	17mm	25mm	6 Costillas K	Lisa
38016	Termoplástico	76mm	17mm	32mm	7 Costillas K	V-Ranurada
38017	Termoplástico	90mm	17mm	22mm	4 Costillas K	V-Ranurada
38018	Termoplástico	70mm	17mm	25mm	6 Costillas K	Lisa
38019	Termoplástico	90mm	17mm	26.3mm	6 Costillas K	V-Ranurada
38020	Acero	90mm	12mm	30.5mm	6 Costillas K	Lisa
38022	Acero	90mm	17mm	37.5mm	8 Costillas K	Lisa
38023	Termoplástico	76mm	17mm	34mm	8 Costillas K	Lisa
38024	Termoplástico	09mm	17mm	26.3mm	6 Costillas K	V-Ranurada
38025	Termoplástico	52mm	17mm	15mm	3 Costillas K	V-Ranurada
38026	Acero	100mm	17mm	28mm	5 Costillas K	Lisa
38027	Termoplástico	82mm	17mm	25mm	6 Costillas K	Lisa
38028	Acero	76mm	17mm	37mm	8 Costillas K	Lisa
38029	Termoplástico	7mm	17mm	26mm	6 Costillas K	V-Ranurada
38030	Acero	70mm	17mm	20.5mm	4 Costillas K	V-Ranurada
38031	Acero	70mm	12mm	20.5mm	4 Costillas K	V-Ranurada
38032	Termoplástico	76mm	17mm	22mm	5 Costillas K	Lisa
38033	Acero	90mm	17mm	33mm	7 Costillas K	Lisa
38034	Termoplástico	27mm	12mm	29mm	6 Costillas K	V-Ranurada
38035**	Acero	94mm		19mm	1/2 V – SAE 13A	V-Ranurada





Productos Gates * FORMAS Y DIMENSIONES

Guía de Poleas DriveAlign®

Listado por número de parte

No. De Parte	Material	Diámetro Exterior	Diámetro del buje	Ancho	Tipo de banda	Superficie de la polea
38036	Acero	81mm	12mm	17.5mm	1/2 V – SAE 13A	V-Ranurada
38037	Acero	81mm	17mm	18mm	1/2 V – SAE 13A	V-Ranurada
38038	Acero	94mm	17mm	19mm	1/2 V – SAE 13A	V-Ranurada
38039**	Acero	94mm		19mm	1/2 V – SAE 13A	V-Ranurada
38040	Acero	123mm	12mm	18.5mm	1/2 V – SAE 13A	V-Ranurada
38041	Acero	76mm	17mm	30.5mm	6 Costillas K	Lisa
38042	Acero	90mm	10mm	30mm	6 Costillas K	Lisa
38043	Acero	76mm	10mm	30mm	6 Costillas K	Lisa
38044	Acero	80mm	17mm	21.8mm	4 Costillas K	V-Ranurada
38045	Termoplástico	70mm	24mm*	28mm	6 Costillas K	Lisa
38046	Termoplástico	80mm	24mm*	27mm	6 Costillas K	Lisa
38047	Termoplástico	70mm	14.5mm*	31.5mm	6 Costillas K	Lisa
38048	Termoplástico	80mm	14.5mm*	31.5mm	6 Costillas K	Lisa
38049**	Acero	80mm		31mm	6 Costillas K	Lisa
38050**	Acero	76mm		31mm	6 Costillas K	Lisa
38051**	Acero	76mm		25mm	6 Costillas K	Lisa
38052	Acero	90mm	17mm	37mm	8 Costillas K	V-Ranurada
38053	Acero	76mm	17mm	38mm	8 Costillas K	V-Ranurada
38058	Termoplástico	76mm	17mm	29.5mm	7 Costillas K	Lisa
38061**	Termoplástico	75mm	24.5mm*	24.5mm	7 Costillas K	Lisa
38062**	Termoplástico	70mm	24mm*	28mm	7 Costillas K	Lisa
38063**	Termoplástico	70mm	17mm	28mm	7 Costillas K	Lisa
38064**	Termoplástico	70mm	24mm*	28mm	7 Costillas K	Lisa
38065**	Termoplástico	70mm	24mm*	28mm	7 Costillas K	Lisa
38066**	Termoplástico	70mm	24mm*	28mm	7 Costillas K	Lisa
38068**	Acero	60mm	25.7mm*	22.5mm	4 Costillas K	V-Ranurada
38069	Termoplástico	80mm	10.2mm	37mm	6 Costillas K	Lisa
38070	Termoplástico	80mm	8mm	21mm	4 Costillas K	Lisa
38071	Termoplástico	70mm	24.5mm*	24.5mm	6 Costillas K	Lisa
38073	Termoplástico	70mm	24mm*	28mm	7 Costillas K	Lisa
38074	Termoplástico	80mm	12.2mm	25mm	6 Costillas K	Lisa
38075	Acero	75mm	30mm	32.5mm	8 Costillas K	Lisa
38076	Acero	75mm	30mm	40mm	10 Costillas K	Lisa
38077	Termoplástico	80mm	17mm	25mm	5 Costillas K	Lisa
38078	Termoplástico	90mm	24.5mm*	27.5mm	6 Costillas K	Lisa
38079	Termoplástico	90mm	24mm*	27.8mm	6 Costillas K	Lisa
38080	Termoplástico	75mm	24mm*	28.5mm	6 Costillas K	V-Ranurada
38081	Termoplástico	80mm	24mm*	31mm	6 Costillas K	Lisa
38082	Termoplástico	63.5mm	17 mm	26.5mm	6 Costillas K	V-Ranurada
38083	Termoplástico	64mm	8.2mm	23mm	6 Costillas K	V-Ranurada
38084	Termoplástico	80mm	14.5mm*	40mm	8 Costillas K	Lisa
38087	Termoplástico	78mm	9mm	25mm	6 Costillas K	Lisa
38088	Acero	70mm	15mm	18mm	3/8 V – SAE 10A	V-Ranurada
38090	Termoplástico	63.5mm	14.5mm*	31mm	6 Costillas K	V-Ranurada
38091	Termoplástico	64mm	14.5mm*	35.5mm	8 Costillas K	V-Ranurada
38092	Termoplástico	70mm	14.5mm*	31mm	6 Costillas K	V-Ranurada
38093	Termoplástico	85mm	14.5mm*	30mm	6 Costillas K	Lisa

* Doble borde ** Esta parte es un montaje del soporte con la polea y por lo tanto faltan algunos datos de medición.





Productos Gates * FORMAS Y DIMENSIONES

Guía de Tensores DriveAlign® y PowerGrip®

Listado por número de parte

No. Parte	Dimensiones
38501	Para Banda de 8 Costillas - Acero (75mm x 30mm x 32.5mm)
38502	Para Banda de 8 Costillas - Acero (75mm x 30mm x 32.5mm)
38503	Para Banda de 10 Costillas - Acero (75mm x 30mm x 40mm)
38504	Para Banda de 10 Costillas - Acero (75mm x 30mm x 40mm)
38505	Para Banda de 6 Costillas - Termoplástico (70mm x 17mm x 25mm)
38506	Para Banda de 10 Costillas - Acero (75mm x 30mm x 40mm)
38507	Acero Poleas/Lisa (75mm x 30mm x 40mm)
38508	Para Banda de 10 Costillas - Acero (75mm x 30mm x 40mm)
38509	Para Banda de 8 Costillas - Acero (75mm x 30mm x 32.5mm)
38510	Acero Poleas/Lisa (75mm x 30mm x 46.5mm)
38511	Para Banda de 10 Costillas - Acero (75mm x 30mm x 40mm)
38512	Para Banda de 10 Costillas - Acero (75mm x 30mm x 40mm)
38513	Para Banda de 10 Costillas - Acero (75mm x 30mm x 40mm)
38514	Para Banda de 10 Costillas - Acero (75mm x 30mm x 40mm)
38524	Acero Poleas/Lisa (75mm x 30mm x 40mm)
38525	Acero Ranurada 8 Costillas (76.8mm x 30mm x 33.3mm)
38527	Acero Ranurada 8 Costillas (76.8mm x 30mm x 33.3mm)
38529	Acero Poleas/Lisa (75mm x 30mm x 46.4mm)
38530	Acero Ranurada 12 Costillas (75mm x 30mm x 47.54mm)
38534	Acero Poleas/Lisa (74mm x 30mm x 46.4mm)
38535	Acero Poleas/Lisa (75mm x 30mm x 46.4mm)
38537	Acero Poleas/Lisa (75mm x 30mm x 46.5mm)
38548	Acero Poleas/Lisa (75mm x 30mm x 32.5mm)
38550	Acero Poleas/Lisa (75mm x 30mm x 40mm)
38567	Acero Poleas/Lisa (75mm x 30mm x 32.5mm)
38568	Acero Poleas/Lisa (75mm x 30mm x 32.5mm)
38569	Acero Poleas/Lisa (75mm x 30mm x 32.5mm)
38578	Acero Poleas/Lisa (75mm x 30mm x 40mm)
38586	Acero Poleas/Lisa (75mm x 30mm x 40mm)
38589	Termoplástico Ranurada 6 Costillas (76mm x 17mm x 25mm)
38597	Acero Poleas/Lisa (75mm x 30mm x 32.5mm)
38598	Acero Poleas/Lisa (75mm x 30mm x 32.5mm)
38599	Termoplástico Ranurada 6 Costillas (76mm x 17mm x 25mm)



Productos Gates * FORMAS Y DIMENSIONES

Nomenclatura de Bandas:

<p>BANDAS V DENTADAS (GS)</p>	<p>Identificación: Los números de la banda indican su ancho y largo, por lo que esta información puede ser usada para identificar el equivalente a una muestra</p> <ul style="list-style-type: none"> El Primer número indica el ancho de la banda en 1/16 de pulgada. Los siguientes tres números indican la longitud, aproximada, de la banda, incluyendo la décima de pulgada; las siglas "GS" indican el tipo de construcción "Green Stripe", la cual es de alto desempeño. 	<p>Ejemplo:</p> <ul style="list-style-type: none"> Número de banda: 6555 GS Ancho (W): El primer dígito es 6 (6555) por lo tanto mide 6/16" que es igual a 3/8". Largo: Los siguientes tres dígitos son 555 que son 55.5 pulgadas es decir 55 1/2 pulgadas de largo. GS: Indica que es dentada.
<p>BANDAS V DENTADAS XL Y LAMINADAS</p>	<p>Identificación: Los números de la banda indican su ancho y largo, por lo que esta información puede ser usada para identificar el equivalente a una muestra</p> <p>El Primer número indica el ancho de la banda en 1/16 de pulgada. Los siguientes tres números indican la longitud aproximada de la banda, incluyendo la décima de pulgada. En algunos casos existe una letra en el número de la Banda, la cual indica una característica especial de construcción, L=laminada.</p>	<p>Ejemplo:</p> <ul style="list-style-type: none"> Número de banda: 9540 Ancho (W): El primer numero es 9 (9540), equivalente a 1/2". Largo: Los siguientes tres dígitos son 540 (9540), los que indican 54.0 pulgadas de largo.
<p>Banda GS® PLATINUM QUALITY</p>	<p>Identificación: Los números de la banda indican su ancho y largo, por lo que esta información puede ser usada para identificar el equivalente a una muestra</p> <p>Las primeras letras indican el nombre de la marca de estas bandas, indicación de Servicio Pesado (PQ=Platinum Quality), los dos primeros números indican el ancho en 1/32" de pulgada; los tres números restantes indican la longitud aproximada en pulgadas, incluyendo la fracción decimal.</p>	<p>Ejemplo:</p> <ul style="list-style-type: none"> Número de banda: PQ17400 Línea: PQ, Platinum Quality Ancho (W): Los dos primeros dígitos son 17 (PQ17400) por lo tanto mide 17/32. Largo: Los siguientes tres dígitos son 400 (PQ17400) que son 40.0 pulgadas..
<p>BANDAS HI-POWER II SECCION A</p>	<p>Identificación: La letra y los números de la banda indican su ancho y largo, por lo que esta información puede ser usada para identificar el equivalente a una muestra</p> <p>La primera letra indica el ancho constante de 1/2" pulgada; los dos números restantes indican la longitud interior en pulgadas; para determinar su longitud exterior se sumarán 2" al número indicado.</p>	<p>Ejemplo:</p> <ul style="list-style-type: none"> Número de banda: A16 Ancho: La letra A indica ancho de 1/2". Largo: Los dos dígitos son 16 (A16) que son 16" pulgadas; la longitud exterior es 16+2=18".
<p>BANDAS HI-POWER II SECCION A</p>	<p>Identificación: La letra y los números de la banda indican su ancho y largo, por lo que esta información puede ser usada para identificar el equivalente a una muestra</p> <p>La primera letra indica el ancho constante de 21/32" pulgada; los dos números restantes indican la longitud interior en pulgadas; para determinar su longitud exterior se sumarán 3" al número indicado.</p>	<p>Ejemplo:</p> <ul style="list-style-type: none"> Número de banda: B50 Ancho: La letra B indica ancho de 21/32". Largo: Los dos dígitos son 50 (B50) que son 50" pulgadas; la longitud exterior es 50+3=53".

Productos Gates * FORMAS Y DIMENSIONES

Nomenclatura de Bandas:

<p>BANDAS MICRO V</p> <p>Pb(mm):3.56 hr(mm):2.4 h(mm) :4.8±0.2 a°:40°±1°</p>	<p>Identificación: La letra y los números de la banda indican el tipo de sección, el número de costillas (ribs) y el largo, por lo que esta información puede ser usada para identificar el equivalente a una muestra</p> <p>La primera letra indica el tipo de sección o distancia entre costilla y costilla; este valor es universal para todas las bandas automotrices a nivel mundial; los dos primeros números indican el número de costillas (ribs) de la banda, y las 4 cifras restantes indican la longitud efectiva en pulgadas.</p>	<p>Ejemplo:</p> <ul style="list-style-type: none"> • <u>Número de banda:</u> K030240 • <u>Sección:</u> Distancia entre costillas, 1/8" • <u>Ribs:</u> La dos cifras indican el número de costillas 03 (K030240). • <u>Largo:</u> Las cuatro cifras restantes indican la longitud efectiva de 24.0" (K030240).
<p>BANDAS TIMING</p>	<p>Identificación: La letra y los números de la banda, exceptuando la "T", no guardan ninguna relación con las dimensiones de la banda u otra de sus características.</p> <p>La "T" indica que se trata de una banda de tiempo. En este tipo de bandas es importante que lo siguiente sea corroborado:</p> <ul style="list-style-type: none"> • Tipo de diente (trapezoidal, curvilíneo, curvilíneo modificado) • Número de dientes. • Ancho de la banda. 	<p>Ejemplo:</p> <ul style="list-style-type: none"> • Hay que referirse a la tabla de dimensiones.



MASTER SERVICIO PESADO 2014

Productos Gates * FORMAS Y DIMENSIONES



Banda V Dentada

Para la transmisión de potencia en poleas en V. Fabricada con dientes moldeados que reducen el patinamiento y el rechinado. Más durables que las bandas lisas por su construcción, materiales y forma.

GS: Bandas dentadas nacional

XL: Bandas dentadas importación

L : Bandas laminadas

Número	Pulg.	mm	Número	Pulg.	mm	Número	Pulg.	mm	Número	Pulg.	mm	Número	Pulg.	mm
Ancho : 1/4"; 6.3 mm														
7261 XL	26 1/4	667	6490 GS	49 1/2	1258	6475 GS	47 1/2	1207	8371 GS	37 1/4	946	8416 GS	41 1/2	1055
7279 XL	28 1/4	718	6494 GS	49 1/2	1258	6480 GS	48 1/4	1226	8380 GS	38 1/4	972	9415 XL	41 7/8	1065
7298 XL	30 1/4	770	6500 GS	50 1/2	1282	7483 XL	48 7/8	1240	8389 GS	38 6/7	987	PQ17420	42 1/4	1073
7309 XL	31 1/4	794	6513 GS	51 1/2	1308	6485 GS	48 5/6	1240	8395 GS	39	990	8435 GS	44	1117
7318 XL	32 1/2	825	6523 GS	52 1/2	1333	6490 GS	49 1/2	1258	8400 GS	40	1015	PQ17430	43 1/2	1104
7329 XL	33 1/4	845	6530 GS	53 1/2	1358	6494 GS	49 3/5	1260	8404 GS	40 1/4	1022	9435 XL	44 3/8	1127
7333 XL	34 1/4	870	6543 GS	54 1/6	1376	6500 GS	50 1/2	1282	8405 GS	40 5/8	1032	8445 GS	44 1/2	1130
7348 XL	35 1/4	895	6555 GS	55 1/2	1410	7508 XL	51 1/8	1300	8416 GS	41 3/4	1060	8450 GS	45 1/2	1155
7359 XL	36 1/4	920	6563 GS	56 3/8	1432	6513 GS	51 1/2	1308	8430 GS	43	1090	8455 GS	46 1/6	1173
7363 XL	36 3/4	935	6567 GS	57	1446	7516 XL	52 1/8	1325	8445 GS	44 1/2	1130	8468 GS	46 3/4	1187
7381 XL	38 1/4	970	6574 GS	57 1/2	1460	6523 GS	52 1/2	1333	8450 GS	45 1/2	1155	8473 GS	47 1/2	1206
7388 XL	39 1/4	995	6580 GS	58 1/2	1485	7525 XL	53 1/8	1350	8452L	45 5/6	1164	8476 GS	48 1/4	1226
Ancho : 5/16"; 8 mm														
5310 GS	31	788	6607 GS	60 3/4	1543	6530 GS	53 1/2	1358	8468 GS	46 3/4	1187	8484 GS	48 1/2	1231
7228 XL	23	584	6615 GS	61 1/2	1562	7535 XL	54 1/8	1375	8473 GS	47 1/2	1206	9490 XL	49 3/8	1255
7234 XL	23 3/4	603	6622 GS	62 1/4	1581	7541 XL	54 5/8	1385	8484 GS	48 1/2	1231	8494 GS	49 1/2	1257
7274 XL	27 1/6	690	6641 GS	64	1628	7545 XL	55 1/8	1400	8494 GS	49 1/2	1257	8500 GS	50 5/8	1286
6305 GS	30 3/4	781	6215 GS	21 3/4	552	6555 GS	55 1/2	1410	8497 GS	50	1271	9505 XL	50 7/8	1290
6325 GS	32 5/6	834	6240 GS	24 5/6	631	7555 XL	56 1/8	1425	8500 GS	50 5/8	1286	8515 GS	51 1/2	1309
7334 XL	33 5/6	859	6250 GS	25 5/8	651	6567 GS	56 3/4	1441	8510 GS	51	1296	8520 GS	52 1/2	1333
7343 XL	34 1/4	870	6255 GS	26 1/6	665	6574 GS	57 1/2	1460	8515 GS	51 1/2	1309	8525 GS	52 3/4	1340
7374 XL	37 5/6	961	6260 GS	26 1/4	667	7575 XL	58 1/8	1475	8520 GS	52 1/2	1333	8533 GS	53 1/2	1358
7379 XL	38 1/4	970	6265 GS	27	684	6580 GS	58 1/2	1485	8533 GS	53 1/2	1358	8543 GS	54 3/8	1381
7384 XL	38 3/4	985	6275 GS	27 1/2	698	6585 GS	58 5/6	1494	8543 GS	54 3/8	1381	9545 XL	54 7/8	1395
7389 XL	39 1/4	995	6280 GS	28 1/2	723	7590 XL	59 5/8	1515	8553 GS	55 5/8	1413	9550 XL	55 3/8	1405
6405 GS	41	1039	6294 GS	29 3/8	746	7597 XL	60 1/8	1525	8563 GS	56 3/8	1432	8563 GS	56 3/8	1432
6420 GS	42 1/2	1079	6295 GS	30	760	7603 XL	60 5/8	1540	8573 GS	57 1/2	1460	9565 XL	57 1/8	1450
7444 XL	44 3/4	1135	6300 GS	30 1/4	768	6615 GS	61 1/2	1562	8580 GS	58 1/2	1485	8573 GS	57 1/2	1460
7459 XL	46 1/4	1175	6312 GS	31 3/8	797	7619 XL	62 5/8	1590	8594 GS	59 3/8	1508	8580 GS	58 1/2	1485
7496 XL	49 5/8	1260	6315 GS	32	811	7625 XL	63 1/8	1605	8608 GS	60 5/6	1545	8585 GS	58 5/6	1494
Ancho : 3/8"; 9.5 mm														
6260 GS	26 1/4	667	6320 GS	32 1/2	825	7630 XL	63 5/8	1615	8616 GS	61 3/4	1568	8594 GS	59 3/8	1508
6263 GS	26 3/8	670	6325 GS	32 5/6	834	7640 XL	64 5/8	1640	8643 GS	64 3/4	1645	8600 GS	60 1/4	1530
6275 GS	27 1/2	698	6328 GS	33	837	7650 XL	65 5/8	1665	8245 GS	25	634	8608 GS	60 5/6	1545
6280 GS	28 1/2	723	6334 GS	33 1/2	850	7660 XL	66 5/8	1690	8255 GS	25 5/6	656	8616 GS	61 1/2	1563
6294 GS	29 3/8	746	6335 GS	33 5/6	859	7665 XL	67 1/8	1705	8260 GS	26 3/8	670	9620 XL	62 3/8	1585
6315 GS	32	811	6340 GS	34 3/8	873	7673 XL	67 5/8	1720	8265 GS	27	686	8625 GS	63 1/4	1607
6320 GS	32 1/2	825	6345 GS	34 5/6	885	7680 XL	68 5/8	1745	8270 GS	27 1/6	690	9630 XL	63 3/8	1610
6334 GS	33 1/2	850	6350 GS	35 1/2	901	7695 XL	70 1/8	1780	9279 XL	28 1/2	723	9635 XL	64 1/8	1630
6340 GS	34 3/8	873	6360 GS	35 5/6	910	7715 XL	72 1/8	1830	8290 GS	29 1/4	743	8643 GS	60 5/8	1540
6352 GS	35 1/4	895	6362 GS	36 1/4	921	7730 XL	73 5/8	1870	8295 GS	30	760	8650 GS	65 1/4	1657
6360 GS	35 5/6	910	6377 GS	37	940	7743 XL	74 5/8	1895	8300 GS	30 1/4	768	8660 GS	66 3/4	1695
6362 GS	36 1/4	921	6370 GS	37 1/4	946	7760 XL	76 5/8	1945	8305 GS	30 5/6	783	9670 XL	67 3/8	1710
6364 GS	36 3/8	924	6375 GS	37 3/4	959	7775 XL	78 1/8	1985	8310 GS	31 1/4	794	8680 GS	68 1/2	1739
6370 GS	37 1/4	946	6380 GS	38 1/4	972	Ancho : 13/32"; 10.3 mm			8313 GS	32	811	9690 XL	69 3/8	1760
6377 GS	37	940	6385 GS	39	991	6208 GS	21 1/2	547	8324 GS	32 1/2	825	9700 XL	70 3/8	1790
6380 GS	38 1/4	972	6390 GS	39 4/9	1002	6305 GS	30 3/4	781	8325 GS	32 3/4	832	9710 XL	71 3/8	1815
6390 GS	39 1/2	1003	6395 GS	39 5/6	1012	Ancho : 7/16"; 11.1 mm			8334 GS	33 1/2	850	9720 XL	72 3/8	1840
6400 GS	40 1/2	1028	6400 GS	40 1/2	1028	7277 GS	27 1/2	698	8335 GS	33 5/6	859	9730 XL	73 3/8	1865
6405 GS	41	1039	6405 GS	40 5/6	1037	7306 GS	30 1/4	768	8345 GS	34 3/8	873	9740 XL	74 3/8	1890
6413 GS	41 3/8	1051	6413 GS	41 3/8	1051	7336L	36 7/8	938	8350 GS	35 1/2	902	9745 XL	74 7/8	1900
6417 GS	42	1065	7417 XL	42 1/8	1070	7362 GS	36 1/6	919	8355 GS	36	916	9755 XL	75 7/8	1925
6427 GS	42 7/8	1089	6420 GS	42 1/4	1073	7371 GS	37 1/6	944	8360 GS	36 1/6	919	9765 XL	76 7/8	1955
6433 GS	43 1/2	1104	6427 GS	42 7/8	1089	7413 GS	41 1/4	1048	8365 GS	37	940	9770 XL	77 3/8	1965
6436 GS	43 5/8	1108	6433 GS	43 1/2	1104	7440 GS	43 5/8	1108	8371 GS	37 1/6	944	9775 XL	77 7/8	1980
6438 GS	43 3/4	1111	6436 GS	43 5/8	1108	Ancho : 1/2"; 12.7 mm			8375 GS	38	966	9810 XL	81 3/8	2065
6444 GS	44 3/8	1127	6444 GS	44 3/8	1127	8310 GS	31 1/4	794	9378 XL	38 1/8	970	9850 XL	85 3/8	2170
6448 XL	45 3/8	1155	7448 XL	45 3/8	1155	8313 GS	32	811	8380 GS	38 1/2	977			
6450 GS	45 1/3	1151	6450 GS	45 1/3	1151	8324 GS	32 1/2	825	8389 GS	39	989			
6453 GS	45 5/8	1159	6453 GS	45 5/8	1159	8325 GS	32 3/4	832	8395 GS	39 1/4	997			
6463 GS	46	1170	6463 GS	46	1170	8334 GS	33 1/2	850	8400 GS	40	1015			
6465 GS	47	1192	6465 GS	47	1192	8335 GS	33 5/6	859	8404 GS	40 1/4	1022			
6471 GS	47 1/2	1206	6471 GS	47 1/2	1206	8345 GS	34 3/8	873	9403 XL	40 5/8	1030			
7473 XL	47 7/8	1215	7473 XL	47 7/8	1215	8350 GS	35 1/2	902	8405 GS	40 5/8	1032			





MASTER SERVICIO PESADO 2014

Productos Gates * FORMAS Y DIMENSIONES



Banda GS® PLATINUM QUALITY

Banda dentada para servicio pesado de alto desempeño. Fabricada con dientes de perfil de larga vida y gran flexibilidad, con fibras sintéticas para mayor resistencia, núcleo tensor Flex-Bonded y cubierta Flex-Weave® para lograr la mejor relación costo/desempeño. Es 33% más durable que la mejor banda para servicio pesado de otros fabricantes.

Número	Longitud Pulg.	Longitud mm	Número	Longitud Pulg.	Longitud mm	Número	Longitud Pulg.	Longitud mm
Ancho: 1/2" - 12.7 mm			PQ24493	49 1/2	1258	PQ28492	49 3/4	1264
PQ17400	40	1014	PQ24495	49 5/6	1266	PQ28497	50 1/2	1282
PQ17420	42 1/2	1079	PQ24503	50 5/8	1286	PQ28501	51	1294
PQ17430	43 1/2	1104	PQ24545	54 7/8	1394	PQ28510	51 1/2	1308
PQ17440	44 1/2	1130	PQ24570	57 1/2	1460	PQ28514	52	1320
PQ17450	45 1/2	1155	PQ24710	71 1/2	1815	PQ28522	52 3/4	1340
PQ17460	46 1/6	1173	PQ24895	90	2288	PQ28545	55	1397
PQ17470	47 1/2	1207	PQ24901	90 1/6	2290	PQ28580	58 1/2	1486
PQ17480	48 1/2	1232	Ancho: 7/8" - 20 mm			PQ28596	60 1/8	1527
PQ17490	49 3/4	1264	PQ28400	40 1/2	1028	PQ28640	64 3/8	1635
Ancho: 1/2" - 12.7 mm			PQ28406	41	1042			
PQ17500	50 5/8	1286	PQ28412	41 3/4	1060			
PQ17510	51 1/2	1308	PQ28423	42 3/4	1086			
PQ17520	52 1/2	1334	PQ28429	43 1/2	1104			
PQ17530	53 1/2	1359	PQ28437	44 1/6	1122			
PQ17540	54 1/2	1384	PQ28445	45	1142			
PQ17550	55 3/4	1416	PQ28454	45 5/6	1164			
Ancho: 11/16" - 17 mm			PQ28463	47	1192			
PQ24315	32	812	PQ28473	47 3/4	1213			
PQ24434	43 5/8	1108	Ancho: 7/8" - 20 mm					
PQ24485	49	1247	PQ28480	48 1/2	1231			
			PQ28483	48 5/6	1240			



Banda Vulco®

Banda forrada recomendada para transmitir potencia y movimiento en poleas en V. Ideal para los motores de Volkswagen enfriados por aire, como el del Sedán por sus características especiales de tensado de la banda.

Número	Ancho y Longitud Pulg.	Ancho y Longitud mm
8234	3/8 x 36	9.5 x 917
8251	1/2 x 56 1/4	12.7 x 1,429
8274	1/2 x 67 1/2	12.7 x 1,713
8282	1/2 x 62 3/4	12.7 x 1,594





MASTER SERVICIO PESADO 2014

Productos Gates * FORMAS Y DIMENSIONES



Banda Super HC®

Banda Industrial para transmitir potencia y movimiento en poleas en V para algunas aplicaciones de servicio pesado.

Número	Ancho y Longitud Pulg.	Ancho y Longitud mm
5V10	5/8 X 71	15.8 X 1803
5V600	5/8 X 60	15.8 X 1524
5V750	5/8 X 75	15.8 X 1905



Banda Truck Belt

Bandas dentadas para servicio pesado con sección SAE.

Número	Pulg.	mm	Número	Pulg.	mm	Número	Pulg.	mm	Número	Pulg.	mm	Número	Pulg.	mm
Ancho= 5/8" - 16 mm			TR22534	53 7/8	1368	TR24530	53 1/2	1359	TR28657	66 1/2	1689	Ancho= 1 1/16" - 27 mm		
TR20412	41 3/4	1060	Ancho= 11/16" - 17 mm			TR24538	54 3/8	1381	TR28666	67 1/4	1708	TR34435		1118
TR20426	43 1/4	1099	TR22553	55 7/8	1419	TR24562	56 3/4	1441	TR28680	68 1/2	1740	TR34456	46 1/4	1175
TR20451	45 5/8	1159	TR22578	58 3/8	1483	TR24578	58 3/8	1483	TR28693	69 7/8	1775	TR34506	51 1/4	1302
TR20544	54 7/8	1394	TR22588	59 3/8	1508	TR24597	60 1/2	1537	TR28706	71 1/4	1810	TR34467	47 1/2	1207
TR20619	62 1/2	1588	TR22607	61 1/2	1562	TR24607	61 1/2	1562	TR28733	73 7/8	1876	TR34495	50	1270
Ancho= 11/16" - 17 mm			TR22625	63	1600	TR24619	62 1/2	1588	TR28743	74 7/8	1902	TR34506	51 1/4	1302
TR22299	30 1/2	775	TR22635	64	1626	TR24638	64 3/8	1635	TR28786	79 1/4	2013	TR34545	55	1397
TR22322	32 3/4	832	TR22648	65 3/8	1661	TR24647	65 1/2	1664	TR28883	88 7/8	2257	TR34603	60 7/8	1546
TR22329	33 1/2	851	TR22657	66 1/2	1689	TR24664	66 7/8	1699	Ancho= 15/16" - 24 mm			TR34604	60 7/8	1546
TR22336	34 1/4	870	TR22664	66 7/8	1699	TR24688	69 3/8	1762	TR30408	41 3/8	1051	TR34625	63	1600
TR22344	34 7/8	886	TR22676	68 1/4	1734	TR24709	71 1/2	1816	TR30428	43 3/8	1102	TR34646	65 1/4	1657
TR22350	35 1/2	902	TR22692	69 3/4	1772	Ancho= 13/16" - 21 mm			TR30448	45 3/8	1153	TR34698	70 3/8	1788
TR22358	36 3/8	924	TR22711	71 5/8	1819	TR26333	33 7/8	860	TR30467	47 1/2	1207	TR34700	70 1/2	1791
TR22363	36 7/8	937	TR22720	72 1/2	1842	TR26341	34 5/8	879	TR30484	48 7/8	1241	TR34711	71 5/8	1819
TR22373	37 7/8	962	TR22752	75 3/4	1924	TR26353	35 7/8	911	TR30506	51 1/4	1302	TR34743	74 7/8	1902
TR22386	39 1/4	997	TR22770	77 1/2	1969	TR26366	37 1/4	946	TR30537	54 1/2	1384	TR34765	77	1956
TR22392	39 3/4	1010	TR22792	79 3/4	2026	Ancho= 7/8" - 22 mm			TR30543	54 7/8	1394	TR34771	77 5/8	1972
TR22397	40 1/2	1029	Ancho= 3/4" - 19 mm			TR28333	33 7/8	860	TR30598	60 3/8	1534	Ancho= 1 3/16" - 30 mm		
TR22400	40 1/2	1029	TR24355	36	914	TR28346	35 1/4	895	TR30624	62 7/8	1597	TR38808	81 3/8	2067
TR22405	41	1041	TR24365	37	940	TR28376	38 1/4	972	TR30652	65 3/4	1670	Ancho= 15/16" - 24 mm		
TR22410	41 1/2	1054	TR24379	38 1/2	978	TR28390	39 1/2	1003	TR30672	67 3/4	1721	TR30698	70 3/8	1788
TR22416	42 1/4	1073	TR24400	40 1/2	1029	TR28406	41 1/4	1048	TR30710	71 1/2	1816	TR30722	72 3/4	1848
TR22425	43	1092	TR24403	40 7/8	1038	TR28445	45	1143	TR30754	75 7/8	1927	TR30770	77 1/2	1969
TR22434	43 7/8	1114	TR24407	41 1/2	1054	Ancho= 7/8" - 22 mm			TR30808	81 3/8	2067	TR30831	83 5/8	2124
TR22443	44 7/8	1140	TR24414	41 7/8	1064	TR28500	55 1/2	1410	TR30857	85 1/2	2167	Ancho= 1" - 25 mm		
TR22448	45 3/8	1153	TR24424	42 7/8	1089	TR28557	56 1/2	1435	TR32491	49 5/8	1260	TR32513	51 7/8	1318
TR22455	46	1168	TR24449	45 1/2	1156	TR28565	57	1448	TR32571	57 5/8	1464	Ancho= 15/16" - 24 mm		
TR22461	46 5/8	1184	TR24465	47	1194	TR28570	57 1/2	1461	Ancho= 15/16" - 24 mm			TR30710	71 1/2	1816
TR22474	47 7/8	1216	TR24476	48 1/4	1226	TR28575	58	1473	TR30722	72 3/4	1848	TR30754	75 7/8	1927
TR22485	49	1245	TR24489	49 1/2	1257	TR28583	58 7/8	1495	TR30770	77 1/2	1969	TR30786	78 1/2	1991
TR22495	50	1270	TR24500	50 1/2	1283	TR28616	62 1/4	1581	TR30808	81 3/8	2067	TR30831	83 5/8	2124
TR22508	51 3/8	1305	TR24515	52	1321	TR28628	63 3/8	1610	TR30857	85 1/2	2167	Ancho= 1" - 25 mm		
TR22514	51 7/8	1318	Ancho= 3/4" - 19 mm			TR28649	65 1/2	1664	TR32491	49 5/8	1260	TR32513	51 7/8	1318
TR22517	52 1/2	1334	TR24355	36	914	Ancho= 15/16" - 24 mm			TR32571	57 5/8	1464	Ancho= 15/16" - 24 mm		
TR22525	53	1346	TR24365	37	940	TR30672	67 3/4	1721	Ancho= 15/16" - 24 mm			TR30698	70 3/8	1788





MASTER SERVICIO PESADO 2014

Productos Gates * FORMAS Y DIMENSIONES



Banda PowerBand®

Bandas unidas para transmitir potencia en poleas en V para aplicaciones de servicio pesado donde las bandas individuales se voltean por el alto torque en el momento del arranque o durante la aceleración.

Número	Bandas Unidas	Longitud Pulg.	mm	Número	Bandas Unidas	Longitud Pulg.	mm	Número	Bandas Unidas	Longitud Pulg.	mm	Número	Bandas Unidas	Longitud Pulg.	mm
Ancho: 1/2"-12.7 mm				Ancho: 1/2"-12.7 mm				Ancho: 1/2"-12.7 mm				Ancho: 7/8"- 22 mm			
2/9305 PB	2	30 7/8	785	2/9510 PB	2	51 7/8	1315	2/9660 PB	2	66 3/8	1685	2/TR28400 PB	2	40 5/9	1030
2/9313 PB	2	32	815	2/9520 PB	2	52 3/8	1330	2/9670 PB	2	67 3/8	1710	2/TR28429 PB	2	43 1/2	1105
2/9325 PB	2	32 7/8	835	2/9530 PB	2	53 3/4	1365	2/9690 PB	2	69 2/3	1770	2/TR28437 PB	2	43 5/7	1110
2/9430 PB	2	43 7/8	1115	2/9540 PB	2	54 5/7	1390	2/9700 PB	2	70 7/8	1800	2/TR28473 PB	2	47 7/8	1215
2/9435 PB	2	44 3/8	1125	2/9545 PB	2	55 1/3	1405	2/9710 PB	2	71 2/3	1820	2/TR28480 PB	2	48 5/8	1220
2/9447 PB	2	45 3/8	1155	2/9550 PB	2	55 5/7	1415	2/9720 PB	2	72 1/4	1835	2/TR28483 PB	2	48 7/8	1240
2/9451 PB	2	45 7/8	1165	2/9555 PB	2	56 1/2	1435	2/9730 PB	2	73 3/8	1865	2/TR28492 PB	2	49 7/8	1265
2/9463 PB	2	46 7/8	1190	2/9570 PB	2	57 2/3	1465	2/9100 PK	2	100	2540	2/TR28501 PB	2	50 4/5	1290
2/9470 PB	2	47 7/8	1215	2/9590 PB	2	59 5/6	1520	2/9103 PK	2	103	2616				
2/9476 PB	2	48 3/8	1230	2/9610 PB	2	61 4/5	1570	2/9104 PK	2	104	2642				
2/9490 PB	2	49 4/5	1265	2/9640 PB	2	64 3/8	1635	2/9105 PK	2	105	2667				
2/9500 PB	2	50 7/9	1290	2/9650 PB	2	65 3/8	1660	2/9106 PK	2	106	2693				



Banda Tri-Power®

Bandas dentada para la transmisión de potencia en poleas en V, en maquinaria industrial y vehículos de servicio pesado. Combina las ventajas de las tradicionales bandas Hi-Power con las de las bandas dentadas.

TIPO "AX"

Número	Longitud Pulg.	Longitud mm	Número	Longitud Pulg.	Longitud mm	Número	Longitud Pulg.	Longitud mm	Número	Longitud Pulg.	Longitud mm	Número	Longitud Pulg.	Longitud mm
Ancho: 1/2"-12.7 mm			Ancho: 1/2" -12.7 mm			Ancho: 1/2"-12.7 mm			Ancho: 1/2"-12.7 mm			Ancho: 1/2"-12.7 mm		
AX22	24	610	AX39	41	1041	AX53	55	1397	AX67	69	1753	AX81	83	2108
AX23	25	635	AX40	42	1067	AX54	56	1422	AX68	70	1778	AX82	84	2134
AX24	26	660	AX41	43	1092	AX55	57	1448	AX69	71	1803	AX85	87	2210
AX26	28	711	AX42	44	1118	AX56	58	1473	AX70	72	1829	AX86	88	2235
AX27	29	737	AX43	45	1143	AX57	59	1499	AX71	73	1854	AX87	89	2261
AX28	30	762	AX44	46	1168	AX58	60	1524	AX72	74	1880	AX88	90	2286
AX29	31	787	AX45	47	1194	AX59	61	1549	AX73	75	1905	AX90	92	2337
AX31	33	838	AX46	48	1219	AX60	62	1575	AX74	76	1930	AX91	93	2362
AX32	34	864	AX47	49	1245	AX61	63	1600	AX75	77	1956	AX92	94	2388
AX33	35	889	AX48	50	1270	AX62	64	1626	AX76	78	1981	AX93	95	2413
AX34	36	914	AX49	51	1295	AX63	65	1651	AX77	79	2007	AX94	96	2438
AX35	37	940	AX50	52	1321	AX64	66	1676	AX78	80	2032	AX96	98	2489
AX36	38	965	AX51	53	1346	AX65	67	1702	AX79	81	2057	AX97	99	2515
AX37	39	991	AX52	54	1372	AX66	68	1727	AX80	82	2083	AX98	100	2540
AX38	40	1016												

TIPO "BX"

Número	Longitud Pulg.	Longitud mm	Número	Longitud Pulg.	Longitud mm	Número	Longitud Pulg.	Longitud mm	Número	Longitud Pulg.	Longitud mm	Número	Longitud Pulg.	Longitud mm
Ancho: 21/32"-16.7 mm			Ancho: 21/32"-16.7 mm			Ancho: 21/32"-16.7 mm			Ancho: 21/32"-16.7 mm			Ancho: 21/32"-16.7 mm		
BX28	31	787	BX45	48	1219	BX58	61	1549	BX71	74	1880	BX84	87	2210
BX31	34	864	BX46	49	1245	BX59	62	1575	BX72	75	1905	BX85	88	2235
BX32	35	889	BX47	50	1270	BX60	63	1600	BX73	76	1930	BX86	89	2261
BX33	37	940	BX48	51	1295	BX61	64	1626	BX74	77	1956	BX87	90	2286
BX35	38	965	BX49	52	1321	BX62	65	1651	BX75	78	1981	BX88	91	2311
BX36	39	991	BX50	53	1346	BX63	66	1676	BX76	79	2007	BX89	92	2337
BX37	40	1016	BX51	54	1372	BX64	67	1702	BX77	80	2032	BX90	93	2362
BX38	41	1041	BX52	55	1397	BX65	68	1727	BX78	81	2057	BX91	94	2388
BX40	43	1092	BX53	56	1422	BX66	69	1753	BX79	82	2083	BX92	95	2413
BX41	44	1118	BX54	57	1448	BX67	70	1778	BX80	83	2108	BX93	96	2438
BX42	45	1143	BX55	58	1473	BX68	71	1803	BX81	84	2134	BX94	97	2464
BX43	46	1168	BX56	59	1499	BX69	72	1829	BX82	85	2159	BX95	98	2489
BX44	47	1194	BX57	60	1524	BX70	73	1854	BX83	86	2184	BX96	99	2515





MASTER SERVICIO PESADO 2014

Productos Gates * FORMAS Y DIMENSIONES

BX97 100 2540



Banda Hi-Power® II

Banda forrada (lisa) industrial de amplia aplicación y desempeño en el mercado automotriz. Fabricada con hule sintético, paredes cóncavas y lomo arqueado, para mayor agarre sobre las poleas.

TIPO "A"

Número	Longitud Pulg.	Longitud mm	Número	Longitud Pulg.	Longitud mm	Número	Longitud Pulg.	Longitud mm	Número	Longitud Pulg.	Longitud mm	Número	Longitud Pulg.	Longitud mm
Ancho: 1"-12.7 mm			Ancho: 1"-12.7 mm			Ancho: 1"-12.7 mm			Ancho: 1"-12.7 mm			Ancho: 1"-12.7 mm		
A16	18	457	A32	34	864	A48	50	1270	A64	66	1676	A84	86	2184
A17	19	483	A33	35	889	A49	51	1295	A65	67	1702	A85	87	2210
A18	20	508	A34	36	914	A50	52	1321	A66	68	1727	A86	88	2235
A19	21	533	A35	37	940	A51	53	1346	A67	69	1753	A87	89	2261
A20	22	559	A36	38	965	A52	54	1372	A68	70	1778	A88	90	2286
A21	23	584	A37	39	991	A53	55	1397	A69	71	1804	A89	91	2311
A22	24	610	A38	40	1016	A54	56	1422	A70	72	1829	A90	92	2337
A23	25	635	A39	41	1041	A55	57	1448	A71	73	1854	A91	93	2362
A24	26	660	A40	42	1067	A56	58	1473	A76	78	1981	A92	94	2388
A25	27	686	A41	43	1092	A57	59	1499	A77	79	2007	A93	95	2413
A26	28	711	A42	44	1118	A58	60	1524	A78	80	2032	A94	96	2438
A27	29	737	A43	45	1143	A59	61	1549	A79	81	2057	A95	97	2464
A28	30	762	A44	46	1168	A60	62	1575	A80	82	2083	A96	98	2489
A29	31	787	A45	47	1194	A61	63	1600	A81	83	2108	A97	99	2515
A30	32	813	A46	48	1219	A62	64	1626	A82	84	2134	A98	100	2540
A31	33	838	A47	49	1245	A63	65	1651	A83	85	2159			

TIPO "B"

Número	Longitud Pulg.	Longitud mm	Número	Longitud Pulg.	Longitud mm	Número	Longitud Pulg.	Longitud mm	Número	Longitud Pulg.	Longitud mm	Número	Longitud Pulg.	Longitud mm
Ancho: 2 1/32"-16.7 mm			Ancho: 2 1/32"-16.7 mm			Ancho: 2 1/32"-16.7 mm			Ancho: 2 1/32"-16.7 mm			Ancho: 2 1/32"-16.7 mm		
B24	27	686	B39	42	1067	B54	57	1448	B69	72	1829	B84	87	2210
B25	28	711	B40	43	1092	B55	58	1473	B70	73	1854	B85	88	2235
B26	29	737	B41	44	1118	B56	59	1499	B71	74	1880	B86	89	2261
B27	30	762	B42	45	1143	B57	60	1524	B72	75	1905	B87	90	2286
B28	31	787	B43	46	1168	B58	61	1549	B73	76	1930	B88	91	2311
B29	32	813	B44	47	1194	B59	62	1575	B74	77	1956	B89	92	2337
B30	33	838	B45	48	1219	B60	63	1600	B75	78	1981	B90	93	2362
B31	34	864	B46	49	1245	B61	64	1626	B76	79	2007	B91	94	2388
B32	35	889	B47	50	1270	B62	65	1651	B77	80	2032	B92	95	2413
B33	36	914	B48	51	1295	B63	66	1676	B78	81	2057	B93	96	2438
B34	37	940	B49	52	1321	B64	67	1702	B79	82	2083	B94	97	2464
B35	38	965	B50	53	1346	B65	68	1727	B80	83	2108	B95	98	2489
B36	39	991	B51	54	1372	B66	69	1753	B81	84	2134	B96	99	2515
B37	40	1016	B52	55	1397	B67	70	1778	B82	85	2159	B97	100	2540
B38	41	1041	B53	56	1422	B68	71	1803	B83	86	2184			





MASTER SERVICIO PESADO 2014

Productos Gates * FORMAS Y DIMENSIONES

K080872 8PK2215 87 7/8 2215 K080893 8PK2269 89 1/3 2268 K080897 8PK2280 89 3/4 2278 K080903 8PK2294 90 1/3 2294

Banda Micro-V®

Número	Número	Longitud Exterior Pulg.	mm	Número	Número	Longitud Exterior Pulg.	mm	Número	Número	Longitud Exterior Pulg.	mm	Número	Número	Longitud Exterior Pulg.	mm
K080910	8PK2311	91 5/8	2311	K081331	8PK3381	133 3/4	3381	K100675	10PK1715	68	1715	K120924	12PK2347	93	2347
K080915	8PK2324	92 1/8	2324	K081359	8PK3452	136 1/4	3452	K100708	10PK1798	70 4/5	1798	K120931	12PK2365	93 3/4	2365
K080922	8PK2342	92 3/4	2342	K081377	8PK3498	138	3498	K100731	10PK1857	73 3/8	1857	K120964	12PK2449	97	2449
K080934	8PK2372	93 7/8	2372	9 costillas 1 1/4" - 32mm				K100739	10PK1877	74	1877	K120979	12PK2487	98	2489
K080944	8PK2398	95	2398	K090500	9PK1270	50 3/8	1280	K100771	10PK1960	77	1958	14 costillas 2" - 50mm			
K080952	8PK2419	95 3/4	2418	K090609	9PK1547	61 1/4	1548	K100789	10PK2004	79 1/4	2004	K140345	14PK877	34 1/2	876
K080968	8PK2460	96 4/5	2459	10 costillas 1 13/32" - 36mm				K100810	10PK2057	81 5/8	2057	K140352	14PK894	35 3/4	894
K080968	8PK2460	96 4/5	2459	K100381	10PK968	39	968	K100852	10PK2164	85 7/8	2165	K140370	14PK940	37 1/2	940
K080975	8PK2475	97 1/2	2477	K100437	10PK1110	44	1110	K100881	10PK2263	89 3/4	2264	K140429	14PK1090	43 1/4	1090
K080981	8PK2492	98	2492	K100445	10PK1130	44 7/8	1130	12 costillas 1 11/16" - 43mm				K140433	14PK1100	43 7/8	1100
K080981	8PK2515	99	2517	K100456	10PK1158	46	1158	K120281	12PK714	28 5/8	714	K140451	14PK1146	45 3/4	1146
K081000	8PK2540	100	2540	K100465	10PK1181	46 1/2	1181	K120360	12PK914	36 1/4	914	K140500	14PK1270	50	1270
K081005	8PK2553	101 1/8	2553	K100485	10PK1232	49	1232	K120390	12PK990	39	991	K140524	14PK1331	53	1331
K081020	8PK2590	102	2591	K100495	10PK1257	49 1/2	1257	K120400	12PK1015	40	1016	K140555	14PK1410	56	1410
K081023	8PK2598	102 7/8	2598	K100510	10PK1295	51 5/8	1295	K120410	12PK1042	41	1041	K140580	14PK1473	58 5/8	1473
K081035	8PK2629	103 1/2	2629	K100535	10PK1360	53 1/2	1359	K120433	12PK1100	43 1/3	1100	K140603	14PK1532	60 1/3	1532
K081075	8PK2731	107 1/2	2731	K100540	10PK1372	54	1372	K120525	12PK1334	53	1334	K140618	14PK1570	62 3/8	1570
K081088	8PK2764	109 3/8	2764	K100554	10PK1407	56	1407	K120559	12PK1420	56 1/2	1420	K140627	14PK1593	63 1/4	1593
K081102	8PK2800	110 1/4	2799	K100563	10PK1430	56 7/8	1430	K120606	12PK1539	61 1/8	1539	K140662	14PK1682	66 1/4	1681
K081124	8PK2855	112 3/8	2855	K100570	10PK1448	57	1448	K120695	12PK1765	69 1/2	1765	K140682	14PK1732	68 3/4	1732
K081145	8PK2908	115 1/8	2908					K120720	12PK1835	72	1829	K140700	14PK1778	70 1/2	1778
K081153	8PK2929	116 1/4	2929	K100575	10PK1461	1/16	1461	K120735	12PK1865	73 1/2	1867				
K081177	8PK2990	118 1/4	2990	K100582	10PK1478	58 3/4	1478	K120740	12PK1880	74	1880				
K081189	8PK3021	119	3020	K100607	10PK1540	60 3/4	1542	K120815	12PK2070	82	2070				
K081196	8PK3038	120	3038	K100630	10PK1601	63	1600	K120842	12PK2139	84 7/8	2139				
K081207	8PK3066	121 1/4	3066	K100640	10PK1626	64	1626	K120864	12PK2195	86 3/8	2195				
K081213	8PK3081	121 7/8	3081	K100655	10PK1664	66	1664	K120872	12PK2215	87 4/5	2215				
K081223	8PK3106	122 3/4	3106	K100665	10PK1690	66 1/2	1689	K120878	12PK2230	88 3/4	2230				
K081251	8PK3178	125 3/8	3178	K100670	10PK1702	67	1702	K120901	12PK2289	90 5/8	2289				
K081265	8PK3213	127	3213					K120911	12PK2314	91 5/8	2314				
K081325	8PK3366	133	3366												





MASTER SERVICIO PESADO 2014

Productos Gates * FORMAS Y DIMENSIONES



H - Abrazaderas Gates

Acero Inoxidable Series 201 y 301

Recomendada para usarse en: Aplicaciones en general, usos automotrices e industriales.

Construcción:

Tornillo: Acero al carbón con recubrimiento de 0.0002" de zinc y adicionalmente con una capa de transparente de dicromato claro, cabeza hexagonal de 5/16".

Caja: Acero al carbón con recubrimiento de 0.0002" de zinc y adicionalmente con una capa de transparente de dicromato claro.

Banda: Acero inoxidable serie 201 y 301, con ranuras paralelas redondeadas, de 1/2" de ancho.

Norma SAE: J1508

Presentación: Ver empaques en la tabla anexa.



TBLS - Abrazaderas Gates

Acero Inoxidable Serie 301

Recomendada para usarse en:

Mangueras de silicón de turbocargador, líneas de entradas de aire, mangueras de agua, bolsas de filtros, mangueras de bombas de agua, mangueras de sistemas de irrigación, etc.

Construcción:

Tornillo: Acero al carbón zincado

Tuerca: Acero al carbón zincado

Resorte: Acero al carbón zincado

Banda: Acero inoxidable serie 301, de 3/4" de ancho.

Presentación: A granel.

N° Parte	Empaque	RANGO DIAM. INT. (PULG.)	
		MIN.	MAX.
MM4 (Micro)	200	1/4	5/8
MM5 (Micro)	100	5/16	29/32
H8	50	7/16	29/32
H10	50	9/16	1-1/16
H12	25	11/16	1-1/4
H16	25	3/4	1-1/2
H20	50	13/16	1-3/4
H24	50	1-1/16	2
H28	50	1-5/16	2-1/4
H32	25	1-9/16	2-1/2
H36	25	1-13/16	2-3/4
H40	25	2-1/16	3
H44	25	2-5/16	3-1/4
H48	25	2-9/16	3-1/2
H52	25	2-13/16	3-3/4
H60	20	3-5/16	4-1/4
H72	20	4-1/6	5
H88	Granel	5-1/16	6
H96	Granel	5-9/16	6-1/2
H104	Granel	6-1/16	7

NO. PARTE	DIAMETRO (IN)		
	NOM.	MIN.	MAX.
TBLS212	1.94	1.82	2.12
TBLS236	2.25	2.06	2.36
TBLS255	2.44	2.25	2.55
TBLS286	2.75	2.56	2.86
TBLS308	3	2.78	3.08
TBLS333	3.25	3.03	3.33
TBLS352	3.44	3.22	3.52
TBLS383	3.75	3.53	3.83
TBLS408	4	3.78	4.08
TBLS433	4.25	4.03	4.33
TBLS436	4.28	4.06	4.36
TBLS458	4.5	4.28	4.58
TBLS483	4.75	4.53	4.83
TBLS508	5	4.78	5.08
TBLS533	5.25	5.03	5.33
TBLS558	5.5	5.28	5.58
TBLS570	5.62	5.4	5.7
TBLS608	6	5.78	6.08
TBLS633	6.25	6.03	6.33
TBLS655	6.47	6.25	6.55
TBLS668	6.6	6.38	6.68
TBLS708	7	6.78	7.08
TBLS758	7.5	7.28	7.58
TBLS780	7.72	7.5	7.8
TBLS783	7.75	7.53	7.83
TBLS858	7.5	8.28	8.58





MASTER SERVICIO PESADO 2014

Productos Gates * FORMAS Y DIMENSIONES



TB - Abrazaderas Gates

Acero Inoxidable Serie 301

Recomendada para usarse en:

Mangueras de silicón de turbocargador, líneas de entradas de aire, mangueras de agua, bolsas de filtros, mangueras de bombas de agua, mangueras de sistemas de irrigación, etc.

Construcción:

Tornillo: Acero al carbón zincado

Tuerca: Acero al carbón zincado.

Banda: Acero inoxidable serie 301, de 3/4" de ancho.

Presentación: A granel.

NO. PARTE GATES	DIAMETRO (IN)		
	NOM.	MIN.	MAX.
TB 206	1.97	1.88	2.06
TB 221	2.14	2.06	2.21
TB 259	2.45	2.31	2.59
TB 265	2.52	2.38	2.65
TB 284	2.7	2.56	2.84
TB 309	2.95	2.81	3.09
TB 321	3.08	2.94	3.21
TB 359	3.45	3.31	3.59
TB 387	3.72	3.56	3.87
TB 409	3.95	3.81	4.09
TB 434	4.2	4.06	4.34
TB 459	4.45	4.31	4.59
TB 487	4.72	4.56	4.87
TB 509	4.95	4.81	5.09
TB 537	5.22	5.06	5.37
TB 562	5.47	5.31	5.62
TB 587	5.72	5.56	5.87
TB 609	5.95	5.81	6.09
TB 637	6.22	6.06	6.37
TB 659	6.45	6.31	6.59
TB 709	6.95	6.81	7.09
TB 737	7.22	7.06	7.37
TB 762	7.48	7.34	7.62
TB 787	7.72	7.56	7.87
TB 812	7.97	7.81	8.12





MASTER SERVICIO PESADO 2014

Destelladores (Flashers) - TRIDON



Recomendada para usarse en:

Los destelladores TRIDON sirven para mantener el control de las luces intermitentes, luces direccionales y exteriores del vehículo. No pueden faltar en vehículos con mayor carga de lámparas que las normales.

Construcción:

- Cubierta: Plástico transparente que soporta altas temperaturas.
- Dispositivo: electromecánico, utilizando la misma energía eléctrica del vehículo.
- Terminales: Dos y tres terminales de latón para tener mejor conductividad.

Tiempo de vida: 100 horas de trabajo continuo.

Norma: FMVSS108, que regula los faros, focos, calaveras y dispositivos de iluminación para los vehículos de pasajeros, camiones, autobuses, trailers, y motocicletas.



DESTELLADORES

✓ **Calidad de EO**
 ✓ **Mayor duración**
 ✓ **Más trabajo continuo**
 ✓ **Controlan hasta 20 luces**
 ✓ **Electromecánicos y electrónicos**
 ✓ **Cubierta resistente a altas temperaturas**
 ✓ **Terminales de paladio = mayor conductividad**

¡Asegúrate que te vean en caso de frenado de emergencia!



Productos Gates * FORMAS Y DIMENSIONES

Tapón de radiador Servicio Pesado



- Dispositivo electromecánico, utilizando la misma energía eléctrica del vehículo.
- Terminales: Dos y tres terminales de latón para tener mejor conductividad.

Por que usar este producto:

Mayor duración:

- Excede requerimientos del equipo original y productos de reemplazo del mercado más en Norteamérica.
- Construido en acero de grueso calibre supera su resistencia a la corrosión, asegurando una larga vida, así como un preciso control de la presión.

Mejor desempeño:

- Control eficiente de la presión gracias a su válvula de tipo atmosférico, evitando así esfuerzos innecesarios en los demás componentes del sistema de enfriamiento.

El estricto control de calidad de nuestros productos garantiza el cumplimiento de las siguientes pruebas:

- Compresión - tensión
- De flujo y sellado
- ambientales
- Goteo de combustible
- Ciclo de válvula
- De impacto
- Resistencia a la vibración prueba de vida
- Torque
- Recuperación de vapores en marcha

Tiempo de vida: La vida de los tapones varía mucho de acuerdo a la máquina donde son instaladas, a las condiciones de operación y al proceso de instalación. Sin embargo se recomienda su revisión y cambio al percibirse que el tapón presenta fugas tanto de vapor como de líquido refrigerante.

Norma: No aplica.

Productos Gates * FORMAS Y DIMENSIONES

Termostato Servicio Pesado



Recomendada para usarse en:

El sistema de enfriamiento como mecanismo de control temperatura en los motores de todo tipo de camiones y equipo de Servicio Pesado.

Construcción:

Termostato de Servicio Pesado en Acero, con la válvula patentada Weir Stat y con componente térmico patentado ELAC.

Por que usar este producto:

Mayor duración:

- Excede requerimientos del equipo original y productos de reemplazo del mercado más en Norteamérica.
- Construido en acero de grueso calibre supera su resistencia a la corrosión, asegurando una larga vida, así como un preciso control de la temperatura.

Mejor desempeño:

- Control eficiente de la temperatura gracias a su válvula Weir-Stat. El estricto control de calidad de nuestros productos garantiza el cumplimiento de operación y control exacto de la temperatura.

Tiempo de vida: La vida de los termostatos varía mucho de acuerdo a la máquina donde son instaladas y a las condiciones de operación. Sin embargo se recomienda su revisión y cambio al efectuar un mantenimiento correctivo al sistema de enfriamiento.

Norma: No aplica.

El termostato con válvula **Weir-Stat** de **Stant**® para **servicio pesado**, es un control utilizado para obtener un **rápido calentamiento del motor al inicio de la operación, manteniendo la temperatura estable durante toda la operación del vehículo**, con este funcionamiento, se evita la frecuente apertura y cierre de la válvula incrementando así la vida útil del termostato, además de prevenir daños por sobre calentamiento durante los periodos de máximo esfuerzo.

- Este es el termostato mas empleado en los motores nuevos.
- El proceso de fabricación de los termostatos esta sujeto a estrictos controles de calidad que garantizan su calibración para una apertura y cierre precisos, lo que se ve reflejado en los siguientes beneficios:
 - **Menor consumo de combustible**
 - **Prolonga la vida del motor**
 - **Calentamiento rápido del motor**
 - **Reducción de emisiones**
 - **Resistencia a la abrasión y corrosión.**



TODO LO QUE NECESITAS PARA TU CAMIONETA H100

HYUNDAI H100

4 CIL, 2.4 L 2003-2005

GATES	DESCRIPCIÓN
6469MC	Banda Motor
6470MC	Banda Motor
CH-119401	Manguera de Radiador
CH-119402	Manguera de Radiador
K040385	Banda Motor
T124	Banda de Distribución
T159	Banda de Distribución
T41044	Tensor de Distribución
T41053	Tensor de Distribución
TCK124AM	Kit de Distribución [4 Componentes]
TCK124M	Kit de Distribución [3 Componentes]

H100

HYUNDAI H100

4 CIL, 2.5 L DIESEL 2006-2003

GATES	DESCRIPCIÓN
CH-119411	Manguera de Radiador
CH-119412	Manguera de Radiador
K040370	Banda Motor
K040415	Banda Motor
K040420	Banda Motor
T1096	Banda de Distribución
T42129	Tensor de Distribución
T42130	Tensor de Distribución
T724	Banda de Distribución
TCK1096M	Kit de Distribución [4 Componentes]

ENERGÍA QUE MUEVE TU PASIÓN



MASTER SERVICIO PESADO 2014

Limpiaparabrisas- Servicio Pesado



Recomendada para usarse en:

Todo tipo de autobuses, camiones y equipo de servicio pesado para limpiar y retirar líquidos que obstruyan la visibilidad en los parabrisas, tanto curvos como planos.

Construcción:

- Estructura: Metálica en color negro y plateado.
- Hule: Resistente al ataque de agentes ambientales, rayos de sol, polvo. Patente exclusiva.

Por que usar este producto:

Mayor Duración:

- El hule utilizado en los limpiaparabrisas TRICO, es una patente exclusiva, libera progresivamente una micro-capa de cera que facilita la limpieza y protege.

Mejor Desempeño

- Son de fácil instalación.
- Alto desempeño, traducido en máxima visibilidad y seguridad.
- Producto especial para camiones, autobuses y equipo de servicio pesado.
- Fácil identificación, en dos tipos:
 - Serie 61: Parabrisas planos.
 - Serie 63: Parabrisas curvos.

Tiempo de vida: Su tiempo de vida es de:

- Cada 6 meses (el hule)
- Antes del inicio de la temporada de lluvias.

Norma: No aplican.

SERIE 61 Para parabrisas planos

- ✓ Estructura de acero
- ✓ Hule natural
 - No se parte
 - No se rompe
 - No se deshace



Descripción TRICO metálico Servicio Pesado Serie 61 V/Plano	Longitud en Pulgadas	Longitud en milímetros	Empaque
61-100	10	254	Sencillo
61-110	11	279	Sencillo
61-120	12	305	Sencillo
61-130	13	330	Sencillo
61-131	13	330	Sencillo
61-140	14	345	Sencillo
61-150	15	381	Sencillo
61-151	15	381	Sencillo
61-160	16	406	Sencillo
61-161	16	406	Sencillo
61-170	17	432	Sencillo
61-180	18	457	Sencillo
61-181	18	457	Sencillo
61-190	19	483	Sencillo
61-200	20	508	Sencillo
61-201	20	508	Sencillo
61-210	21	533	Sencillo
61-220	22	559	Sencillo

SERIE 63 Para parabrisas Curvos o planos.

Dimensión y Empaque

- ✓ Estructura de alta resistencia
- ✓ Hule natural
 - No se parte
 - No se rompe
 - No se deshace

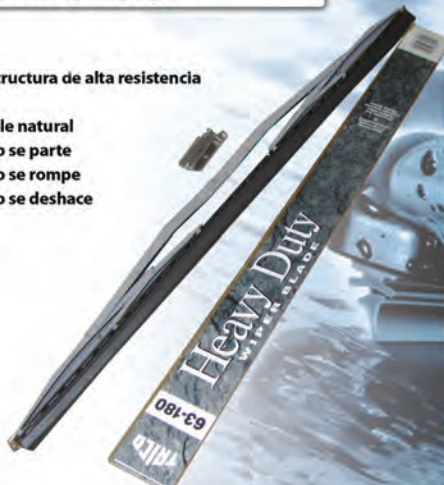

Descripción TRICO metálico Servicio PEsado Serie 63 V/Curvo	Longitud en Pulgadas	Longitud en milímetros	Empaque
63-120	12	305	Sencillo
63-140	14	345	Sencillo
63-141	14	345	Sencillo
63-151	15	381	Sencillo
63-160	16	406	Sencillo
63-180	18	457	Sencillo
63-181	18	457	Sencillo
63-200	20	508	Sencillo
63-201	20	508	Sencillo



Bombas de Servicio Pesado

**Recomendada para usarse en:**

En camiones y vehículos de servicio pesado.

Construcción:

Acero

Por que usar este producto:

El complemento perfecto para los ensambles de Dirección Hidráulica, haciendo 100% eficiente el Sistema de Dirección de los vehículos.

El estricto control de calidad de nuestros productos garantiza el cumplimiento de las siguientes pruebas:

- Flujo
- Presión

Tiempo de vida:

Las bombas tienen la ventaja de:

- Se prueba el 100% de las bombas antes de salir de la planta.
 - Amplia cobertura de aplicaciones.
- Apoyo técnico en caso de ser requerido.

Norma: No aplica.

- ✓ DRENAR EL ACEITE USADO DE TODO EL SISTEMA
- ✓ USAR SIEMPRE ACEITE NUEVO
- ✓ PURGAR EL SISTEMA COMPLETO (RELLENE CON ACEITE NUEVO CONTINUAMENTE HASTA QUE SALGA POR EL OTRO EXTREMO ACEITE LIMPIO)
- ✓ NO APOYAR EN LA FLECHA DE LA BOMBA PARA PONER LA POLEA
- ✓ VERIFICAR QUE LAS MANGUERAS ESTEN EN BUEN ESTADO (NO OBSTRUIDAS, NO DESGARRADAS, NO RESECAS)
- ✓ ESTE PRODUCTO DEBE SER INSTALADO POR UN MECANICO CAPACITADO
- ✓ SIEMPRE TRABAJE EN UN LUGAR LIMPIO PARA EVITAR CONTAMINACIÓN
- ✓ SI LA BOMBA CUENTA CON VALVULA ELECTRONICA (SENSOR DE PRESION) CAMBIELO A LA BOMBA NUEVA



MASTER SERVICIO PESADO 2014

Ofrece el servicio más completo integrando las Bombas de Agua de Servicio Pesado Gates

B.A.	Marca	Modelo	Motor	Años	Imagen
45054 HD *	International/Navistar	9900i	ISX Diesel	2003-2007	
45051 HD *	Kenworth	T600 T660 T800	ISX Diesel	2010-2014	
45053 HD *	Mercedes Benz	MBE906	MBE906	2000-2005	
45050 HD *	Mercedes Benz	MBE904	MBE904	2003	
42291	Dodge	Ram 4000 Pick Up Ram 4500HD & Ram 5500HD	6 Cil. 6.7 L Diesel	2007-2011	
43541	Ford	Super Duty Pick Up & Van	V8, 6.0 L Diesel	2004-2010	
	Ford	E450 Super Duty	V8, 6.0 L Diesel	2004-2010	
	Ford	F450, F550 & F650 Super Duty	V8, 6.0 L Diesel	2004-2008	
43439	Freightliner	Business Class M2	Caterpillar C9 Diesel	2004-2008	
	Sterling	A-Line, Acterra & L-Line	Caterpillar C9 Diesel	2004-2008	
42146	Freightliner	Business Class M2	Cummins ISC Diesel	2004-2008	
	Freightliner	FL50, FL60, FL70 & FL80	Cummins ISC Diesel	1998-2005	
	Kenworth	T300	Cummins ISC Diesel	1998-2009	
	Kenworth	T800	Cummins ISL Diesel	2000-2009	
	Sterling	L-Line	Cummins ISC Diesel	1998-2008	
	Sterling	Acterra	Cummins ISC Diesel	2001-2009	
44052	Freightliner	Argosy, Centuru Class, Classic, Classic XL & Columbia	Cummins N14 Diesel	1996-2003	
	Freightliner	FLC & FLD	Cummins N14 Diesel Cummins 6 Cil. 14.0 Lts.	1991-2003	
	Ford	L8000 & L9000	Cummins N14 Diesel	1991-1997	
	International	500, 550i, 5600i, 5900i, 8100, 9100, 9200, 9400 & 9400i	Cummins N14 Diesel	1991-2003	
	Kenworth	T600, T800, T2000 & W900	Cummins N14 Diesel	1992-2003	
	Sterling	A-Line, Acterra & L-Line	Cummins N14 Diesel	1998-2003	
	Volvo	Series VN & VHD	Cummins N14 Diesel	1998-2003	





MASTER SERVICIO PESADO 2014

No sólo te acompañamos en el trayecto, también nos aseguramos de que llegues a tu destino



44054	Freightliner	Argosy & Century Class	Caterpillar 3406 Diesel	1996-2002	
	Freightliner	FLC & FLD	Caterpillar 3406 Diesel	1993-2000	
	Ford	L8000 & L9000	Caterpillar 3406 Diesel	1994-1997	
	International	9200, 9400, 9400i, 9900i & 9900ix	Caterpillar 3406 Diesel	1993-2000	
	Kenworth	T600, T800, T2000 & W900	Caterpillar 3406 Diesel	1993-2000	
	Sterling	A-Line & L-Line	Caterpillar 3406 Diesel	1998-2002	
	Volvo	Series VN	Caterpillar 3406 Diesel	1997-2000	
43545	International	4700, 4800 & 4900	Navistar T444 Diesel	1997-2002	
	International	4100, 4200, 4300 & 4400	Navistar VT365 Diesel	2003-2007	
	International	3800	Navistar T444 Diesel	2000-2005	
44066	Ford	L8000 & L9000	Detroit Diesel Series 60 Detroit Diesel 6 Cil. 11.1 L Detroit Diesel 6 Cil. 12.7 L	1991-1998	
	Freightliner	Century Class	Detroit Diesel 6 Cil. 12.7 L Diesel	1996-2006	
	Freightliner	Argosy, Columbia, Classic & Coronado	Detroit Diesel 6 Cil. 12.7 L Diesel	1999-2009	
	Ford	L8000 & L9000	Detroit Diesel SerieS 60	1991-1998	
	Freightliner	FL 106	Detroit Diesel Series 50	1994-2002	
	Freightliner	FL 112 & Century Class	Detroit Diesel Series 55	1996-1999	
	Freightliner	Argosy, Centuru Class, Classic, Classic XL & Columbia	Detroit Diesel 6 Cil. 11.1 L	1996-2003	
	Freightliner	Argosy, Centuru Class, Classic, Classic XL, Columbia & Coronado	Detroit Diesel 6 Cil. 12.7 L	1996-2009	
	Freightliner	FLC	Detroit Diesel 6 Cil. 12.7 L	1991-1999	
	Freightliner	FLD	Detroit Diesel 6 Cil. 12.7 L	1991-2008	
	Freightliner	FLA & FLB	Detroit Diesel 6 Cil. 12.7 L	1991-1999	
	Freightliner	Argosy, Centuru Class, Classic, Classic XL, Columbia, Coronado & FLD	Detroit Diesel 6 Cil. 14.0 L	2001-2008	
	International	8100, 8200,	Detroit Diesel Series 50	1994-1998	
	International	9100, 9200 & 9400	Detroit Diesel Series 60	1997-2000	
	International	8200, 8300 & 9300	Detroit Diesel 6 Cil. 11.1 L	1991-1997	
	International	8200, 8300 & 9300	Detroit Diesel 6 Cil. 12.7 L	1991-1997	
	Kenworth	T600, T800 & W900	Detroit Diesel 6 Cil. 11.1 L	1991-2001	
	Kenworth	T2000	Detroit Diesel 6 Cil. 11.1 L	1997-2000	
	Kenworth	T600, T800 & W900	Detroit Diesel 6 Cil. 12.7 L	1991-2001	
	Kenworth	T2000	Detroit Diesel 6 Cil. 12.7 L	1997-2000	
	Mack	Series CL	Detroit Diesel 6 Cil. 12.7 L	1992-1999	
	Sterling	A-Line & L-Line	Detroit Diesel 6 Cil. 11.1 L	1998-2002	
	Sterling	A-Line & L-Line	Detroit Diesel 6 Cil. 12.7 L	1998-2007	
Sterling	A-Line & L-Line	Detroit Diesel 6 Cil. 14.0 L	2003-2007		
41175	Ford	L8000 & L9000	Cummins L10 Diesel	1991-1997	
	Freightliner	FLA, FLB, FLC, FLD & FLL	Cummins L10 Diesel	1990-1996	
	International	5000, 8100 & 8200	Cummins L10 Diesel	1991-1998	
	Kenworth	T400, T450, T600 & T800	Cummins L10 Diesel	1991-1998	







MASTER SERVICIO PESADO 2014

Productos Gates * FORMAS Y DIMENSIONES

TABLA DE APLICACIONES DE BOMBAS DIRECCION HIDRAULICA DE SERVICIO PESADO

NUMERO DE PARTE GATES	VEHICULO	MODELO	MOTOR	SERIE	ROTACION	ORIGINAL	PRESION
						NUMERO	PSI
 BDH-7546-A	DINA	9400	CUMMINS	N14	DERECHA	1663204 C91	2175.56
	DINA	9400	CUMMINS	N14	DERECHA	1663204 C91	2175.56
	FREIGHTLINER	ARGOSY	CATERPILLAR	3126	DERECHA	1663204 C91	2175.56
	FREIGHTLINER	C 120	CATERPILLAR	3126	DERECHA	1663204 C91	2175.56
	FREIGHTLINER	C 120	DETROIT DIESEL	SERIE 60	DERECHA	1663204 C91	2175.56
	FREIGHTLINER	COLUMBIA	CATERPILLAR	3126	DERECHA	1663204 C91	2175.56
	FREIGHTLINER	COLUMBIA	DETROIT DIESEL	SERIE 60	DERECHA	1663204 C91	2175.56
	FREIGHTLINER	CST 120	CUMMINS	N14	DERECHA	1663204 C91	2175.56
	FREIGHTLINER	FLD 120	CUMMINS	N14	DERECHA	1663204 C91	2175.56
	INTERNATIONAL	9200	CUMMINS	N14	DERECHA	1663204 C91	2175.56
	INTERNATIONAL	9400	CUMMINS	N14	DERECHA	1663204 C91	2175.56
	INTERNATIONAL	9400 i	CUMMINS	N14	DERECHA	1663204 C91	2175.56
	INTERNATIONAL	DAY CAB	CUMMINS	N14	DERECHA	1663204 C91	2175.56
	INTERNATIONAL	DAY CAB DDC	CUMMINS	N14	DERECHA	1663204 C91	2175.56
	KENWORTH	T600	CUMMINS	N14	DERECHA	1663204 C91	2175.56
	KENWORTH	T600B	CUMMINS	N14	DERECHA	1663204 C91	2175.56
	KENWORTH	T800	CUMMINS	N14	DERECHA	1663204 C91	2175.56
	KENWORTH	T800B	CUMMINS	N14	DERECHA	1663204 C91	2175.56
	KENWORTH	T800B	CUMMINS	C10	DERECHA	1663204 C91	2175.56
	KENWORTH	T800B	CUMMINS	C12	DERECHA	1663204 C91	2175.56
	KENWORTH	T800B SH	CUMMINS	C10	DERECHA	1663204 C91	2175.56
	KENWORTH	T800B SH	CUMMINS	C12	DERECHA	1663204 C91	2175.56
	KENWORTH	T800B	CUMMINS	N14	DERECHA	1663204 C91	2175.56
	KENWORTH	W900	CUMMINS	C12	DERECHA	1663204 C91	2175.56
	KENWORTH	W924	CUMMINS	C12	DERECHA	1663204 C91	2175.56
	KENWORTH	T2000	CUMMINS	N14	DERECHA	1663204 C91	2175.56
	KENWORTH	T2000	CUMMINS	C12	DERECHA	1663204 C91	2175.56

NUMERO DE PARTE GATES	VEHICULO	MODELO	MOTOR	SERIE	ROTACION	ORIGINAL	PRESION
						NUMERO	PSI
 BDH-7550-A	DINA	861 K	DETROIT DIESEL	SERIE 60	IZQUIERDA	1682625 C91	2175.56
	DINA	9400	DETROIT DIESEL	SERIE 60	IZQUIERDA	1682625 C91	2175.56
	DINA	PARADISO	DETROIT DIESEL	SERIE 60	IZQUIERDA	1682625 C91	2175.56
	DINA	VIAGGIO	DETROIT DIESEL	SERIE 60	IZQUIERDA	1682625 C91	2175.56
	DINA	F 12	DETROIT DIESEL	SERIE 60	IZQUIERDA	1682625 C91	2175.56
	DINA	F 14	DETROIT DIESEL	SERIE 60	IZQUIERDA	1682625 C91	2175.56
	FREIGHTLINER	FL 106	DETROIT DIESEL	SERIE 50	IZQUIERDA	1682625 C91	2175.56
	FREIGHTLINER	FLD 112	DETROIT DIESEL	SERIE 50	IZQUIERDA	1682625 C91	2175.56
	FREIGHTLINER	FLD 120	DETROIT DIESEL	SERIE 60	IZQUIERDA	1682625 C91	2175.56
	INTERNATIONAL	4300	NAVISTAR	DT 466	IZQUIERDA	1682625 C91	2175.56
	INTERNATIONAL	9200	DETROIT DIESEL	SERIE 60	IZQUIERDA	1682625 C91	2175.56
	INTERNATIONAL	9400	DETROIT DIESEL	SERIE 60	IZQUIERDA	1682625 C91	2175.56
	INTERNATIONAL	9400 i	DETROIT DIESEL	SERIE 60	IZQUIERDA	1682625 C91	2175.56
	INTERNATIONAL	DAY CAB	DETROIT DIESEL	SERIE 60	IZQUIERDA	1682625 C91	2175.56
	INTERNATIONAL	DAY CAB DDC	DETROIT DIESEL	SERIE 60	IZQUIERDA	1682625 C91	2175.56
	KENWORTH	T600	CATERPILLAR	SERIE 60	IZQUIERDA	1682625 C91	2175.56
	KENWORTH	T600B	CATERPILLAR	SERIE 60	IZQUIERDA	1682625 C91	2175.56
	KENWORTH	T800	CATERPILLAR	SERIE 60	IZQUIERDA	1682625 C91	2175.56
	KENWORTH	T800B	CATERPILLAR	SERIE 60	IZQUIERDA	1682625 C91	2175.56
	KENWORTH	T800B	CATERPILLAR	SERIE 50	IZQUIERDA	1682625 C91	2175.56
	KENWORTH	T800B	CATERPILLAR	SERIE 50	IZQUIERDA	1682625 C91	2175.56
	KENWORTH	W900	DETROIT DIESEL	SERIE 60	IZQUIERDA	1682625 C91	2175.56
	KENWORTH	W924	DETROIT DIESEL	SERIE 60	IZQUIERDA	1682625 C91	2175.56
	KENWORTH	T2000	DETROIT DIESEL	SERIE 60	IZQUIERDA	1682625 C91	2175.56
	MASA VOLVO	BUSSCAR	DETROIT DIESEL	SERIE 60	IZQUIERDA	1682625 C91	2175.56
	MASA VOLVO	HALCON	DETROIT DIESEL	SERIE 60	IZQUIERDA	1682625 C91	2175.56
	MASA VOLVO	JAGUAR	DETROIT DIESEL	SERIE 60	IZQUIERDA	1682625 C91	2175.56
	MASA VOLVO	STRADA	DETROIT DIESEL	SERIE 50	IZQUIERDA	1682625 C91	2175.56





MASTER SERVICIO PESADO 2014

Productos Gates * FORMAS Y DIMENSIONES

NUMERO DE PARTE GATES	VEHICULO	MODELO	MOTOR	SERIE	ROTACION	ORIGINAL NUMERO	PRESION PSI
 BDH-7235-H	MERCEDES BENZ	L1114	MERCEDES BENZ	OM 366	DERECHA	A001 466 18 01	1450.38
	MERCEDES BENZ	L1314	MERCEDES BENZ	OM 366	DERECHA	A001 466 18 01	1450.38
	MERCEDES BENZ	L1317	MERCEDES BENZ	OM 366	DERECHA	A001 466 18 01	1450.38
	MERCEDES BENZ	L1321	MERCEDES BENZ	OM 366	DERECHA	A001 466 18 01	1450.38
	MERCEDES BENZ	LK1314	MERCEDES BENZ	OM 366	DERECHA	A001 466 18 01	1450.38
	MERCEDES BENZ	LK1317	MERCEDES BENZ	OM 366	DERECHA	A001 466 18 01	1450.38
	MERCEDES BENZ	LK1321	MERCEDES BENZ	OM 366	DERECHA	A001 466 18 01	1450.38
	MERCEDES BENZ	L1200 / 52	MERCEDES BENZ	OM 904	DERECHA	A001 466 18 01	1450.38
	MERCEDES BENZ	L1218 / 52	MERCEDES BENZ	OM 904	DERECHA	A001 466 18 01	1450.38
	MERCEDES BENZ	L1400 / 52	MERCEDES BENZ	OM 904	DERECHA	A001 466 18 01	1450.38
	MERCEDES BENZ	L1418 / 39	MERCEDES BENZ	OM 904	DERECHA	A001 466 18 01	1450.38
	MERCEDES BENZ	L1417 / 52	MERCEDES BENZ	OM 366	DERECHA	A001 466 18 01	1450.38
	MERCEDES BENZ	L1417 / 34	MERCEDES BENZ	OM 366	DERECHA	A001 466 18 01	1450.38
	MERCEDES BENZ	L1419 / 59	MERCEDES BENZ	OM 366	DERECHA	A001 466 18 01	1450.38
	MERCEDES BENZ	L1518 / 52	MERCEDES BENZ	OM 904	DERECHA	A001 466 18 01	1450.38
	MERCEDES BENZ	L1517 / 59	MERCEDES BENZ	OM 366	DERECHA	A001 466 18 01	1450.38
	MERCEDES BENZ	L1619 / 52	MERCEDES BENZ	OM 366	DERECHA	A001 466 18 01	1450.38
	MERCEDES BENZ	L1619 / 59	MERCEDES BENZ	OM 366	DERECHA	A001 466 18 01	1450.38
	MERCEDES BENZ	L1621 / 54	MERCEDES BENZ	OM 366	DERECHA	A001 466 18 01	1450.38
	MERCEDES BENZ	L1621 / 59	MERCEDES BENZ	OM 366	DERECHA	A001 466 18 01	1450.38
	MERCEDES BENZ	L1621 / 60	MERCEDES BENZ	OM 366	DERECHA	A001 466 18 01	1450.38
	MERCEDES BENZ	L1621 / 70	MERCEDES BENZ	OM 366	DERECHA	A001 466 18 01	1450.38
	MERCEDES BENZ	L2121 / 54	MERCEDES BENZ	OM 366	DERECHA	A001 466 18 01	1450.38
	MERCEDES BENZ	OMC1418 / 51	MERCEDES BENZ	OM 904	DERECHA	A001 466 18 01	1450.38
	MERCEDES BENZ	O400 RSD MP120	MERCEDES BENZ	OM 447	DERECHA	A001 466 18 01	1450.38
	MERCEDES BENZ	O400 RSD MP120	MERCEDES BENZ	OM 457LA	DERECHA	A001 466 18 01	1450.38
	MERCEDES BENZ	O400 RSE MP105	MERCEDES BENZ	OM 447	DERECHA	A001 466 18 01	1450.38
	MERCEDES BENZ	O400 RSE MP105	MERCEDES BENZ	OM 457LA	DERECHA	A001 466 18 01	1450.38
	MERCEDES BENZ	O400 RSD MP155	MERCEDES BENZ	OM 447	DERECHA	A001 466 18 01	1450.38
	MERCEDES BENZ	O400 RSD MP155	MERCEDES BENZ	OM 457LA	DERECHA	A001 466 18 01	1450.38
	MERCEDES BENZ	O400 RSD MP180	MERCEDES BENZ	OM 447	DERECHA	A001 466 18 01	1450.38
	MERCEDES BENZ	O400 RSD MP180	MERCEDES BENZ	OM 457LA	DERECHA	A001 466 18 01	1450.38
	MERCEDES BENZ	TORINO OMC1419	MERCEDES BENZ	OM 904	DERECHA	A001 466 18 01	1450.38

NUMERO DE PARTE GATES	VEHICULO	MODELO	MOTOR	SERIE	ROTACION	ORIGINAL NUMERO	PRESION PSI
 BDH-4510-A	MERCEDES BENZ	L1417 / 52	MERCEDES BENZ	OM 366	DERECHA	A002 460 55 80	1885.49
	MERCEDES BENZ	L1417 / 34	MERCEDES BENZ	OM 366	DERECHA	A002 460 55 80	1885.49
	MERCEDES BENZ	L1419 / 59	MERCEDES BENZ	OM 366	DERECHA	A002 460 55 80	1885.49
	MERCEDES BENZ	L1517 / 59	MERCEDES BENZ	OM 366	DERECHA	A002 460 55 80	1885.49
	MERCEDES BENZ	L1619 / 52	MERCEDES BENZ	OM 366	DERECHA	A002 460 55 80	1885.49
	MERCEDES BENZ	L1619 / 59	MERCEDES BENZ	OM 366	DERECHA	A002 460 55 80	1885.49
	MERCEDES BENZ	L1621 / 54	MERCEDES BENZ	OM 366	DERECHA	A002 460 55 80	1885.49
	MERCEDES BENZ	L1621 / 59	MERCEDES BENZ	OM 366	DERECHA	A002 460 55 80	1885.49
	MERCEDES BENZ	L1621 / 60	MERCEDES BENZ	OM 366	DERECHA	A002 460 55 80	1885.49
	MERCEDES BENZ	L1621 / 70	MERCEDES BENZ	OM 366	DERECHA	A002 460 55 80	1885.49
	MERCEDES BENZ	L2121 / 54	MERCEDES BENZ	OM 366	DERECHA	A002 460 55 80	1885.49
	MERCEDES BENZ	OF1318 / 51	MERCEDES BENZ	OM 366	DERECHA	A002 460 55 80	1885.49
	MERCEDES BENZ	BOXER LO1300	MERCEDES BENZ	OM 366	DERECHA	A002 460 55 80	1885.49







MASTER SERVICIO PESADO 2014

Productos Gates * FORMAS Y DIMENSIONES

NUMERO DE PARTE GATES	VEHICULO	MODELO	MOTOR	SERIE	ROTACION	ORIGINAL NUMERO	PRESION PSI
 BDH-8204-H	FREIGHTLINER	FL 60	MERCEDES BENZ	SERIE 900	IZQUIERDA	14 13835 000	2175.56
	FREIGHTLINER	FL 70	MERCEDES BENZ	SERIE 900	IZQUIERDA	14 13835 000	2175.56
	FREIGHTLINER	FL 80	CUMMINS	ISB	IZQUIERDA	14 13835 000	2175.56
	FREIGHTLINER	FL 80 QR 4X2	MERCEDES BENZ	SERIE 900	IZQUIERDA	14 13835 000	2175.56
	MERCEDES BENZ	L1417 / 52	MERCEDES BENZ	OM 366	IZQUIERDA	14 13835 000	2175.56
	MERCEDES BENZ	L1417 / 34	MERCEDES BENZ	OM 366	IZQUIERDA	14 13835 000	2175.56
	MERCEDES BENZ	L1419 / 59	MERCEDES BENZ	OM 366	IZQUIERDA	14 13835 000	2175.56
	MERCEDES BENZ	L1517 / 59	MERCEDES BENZ	OM 366	IZQUIERDA	14 13835 000	2175.56
	MERCEDES BENZ	L1619 / 52	MERCEDES BENZ	OM 366	IZQUIERDA	14 13835 000	2175.56
	MERCEDES BENZ	L1619 / 59	MERCEDES BENZ	OM 366	IZQUIERDA	14 13835 000	2175.56
	MERCEDES BENZ	L1621 / 54	MERCEDES BENZ	OM 366	IZQUIERDA	14 13835 000	2175.56
	MERCEDES BENZ	L1621 / 59	MERCEDES BENZ	OM 366	IZQUIERDA	14 13835 000	2175.56
	MERCEDES BENZ	L1621 / 60	MERCEDES BENZ	OM 366	IZQUIERDA	14 13835 000	2175.56
	MERCEDES BENZ	L1621 / 70	MERCEDES BENZ	OM 366	IZQUIERDA	14 13835 000	2175.56
MERCEDES BENZ	L2121 / 54	MERCEDES BENZ	OM 366	IZQUIERDA	14 13835 000	2175.56	

NUMERO DE PARTE GATES	VEHICULO	MODELO	MOTOR	SERIE	ROTACION	ORIGINAL NUMERO	PRESION PSI
 BDH-7611-A	DINA	751 MULT	CUMMINS	DT 530	DERECHA	2005337 C91	2364.12
	DINA	751 MULT	CUMMINS	DT 530	DERECHA	2005337 C91	2364.12
	DINA	7400 240	CUMMINS	DT 530	DERECHA	2005337 C91	2364.12
	DINA	7400 240	CUMMINS	DT 530	DERECHA	2005337 C91	2364.12
	INTERNATIONAL	3000 RE	NAVISTAR	DT 466	DERECHA	2005337 C91	2364.12
	INTERNATIONAL	4400	NAVISTAR	DT 466	DERECHA	2005337 C91	2364.12
	INTERNATIONAL	4700 SCD	NAVISTAR	T 444E	DERECHA	2005337 C91	2364.12
	INTERNATIONAL	4700 FBC	NAVISTAR	DT 466	DERECHA	2005337 C91	2364.12
	INTERNATIONAL	4900 / 210 / 215	NAVISTAR	DT 466	DERECHA	2005337 C91	2364.12
	INTERNATIONAL	4900 / 250 / 300	NAVISTAR	DT 466	DERECHA	2005337 C91	2364.12
	INTERNATIONAL	7400	INTERNATIONAL	DT 350	DERECHA	2005337 C91	2364.12

NUMERO DE PARTE GATES	VEHICULO	MODELO	MOTOR	SERIE	ROTACION	ORIGINAL NUMERO	PRESION PSI
 BDH-5333-A	DINA	455 OF	NAVISTAR	DT 466	IZQUIERDA	1686649 C91	2364.16
	INTERNATIONAL	4300	NAVISTAR	DT 466	IZQUIERDA	1686649 C91	2364.16
	INTERNATIONAL	4400	NAVISTAR	DT 466	IZQUIERDA	1686649 C91	2364.16
	INTERNATIONAL	4700 SCD	NAVISTAR	T444E	IZQUIERDA	1686649 C91	2364.16
	INTERNATIONAL	4700 FBC	NAVISTAR	DT 466	IZQUIERDA	1686649 C91	2364.16







MASTER SERVICIO PESADO 2014

Productos Gates * FORMAS Y DIMENSIONES

NUMERO DE PARTE GATES	VEHICULO	MODELO	MOTOR	SERIE	ROTACION	ORIGINAL NUMERO	PRESION PSI
 BDH-8320-A	FREIGHTLINER	ARGOSY	CUMMINS	M11	IZQUIERDA	3187858	2175.56
	FREIGHTLINER	C 120	CUMMINS	M11	IZQUIERDA	3187858	2175.56
	FREIGHTLINER	COLUMBIA	CUMMINS	M11	IZQUIERDA	3187858	2175.56
	FREIGHTLINER	FL 112	CUMMINS	M11	IZQUIERDA	3187858	2175.56
	FREIGHTLINER	FL 112 QR	CUMMINS	M11	IZQUIERDA	3187858	2175.56
	FREIGHTLINER	FL 112 SR	CUMMINS	M11	IZQUIERDA	3187858	2175.56
	FREIGHTLINER	FLD 112	CUMMINS	M11	IZQUIERDA	3187858	2175.56
	FREIGHTLINER	FLD 120	CUMMINS	M11	IZQUIERDA	3187858	2175.56
	INTERNATIONAL	9200	CUMMINS	M11	IZQUIERDA	3187858	2175.56
	INTERNATIONAL	9200 i	CUMMINS	M11	IZQUIERDA	3187858	2175.56
	INTERNATIONAL	DAY CAB	CUMMINS	M11	IZQUIERDA	3187858	2175.56
	INTERNATIONAL	DAY CAB DDC	CUMMINS	M11	IZQUIERDA	3187858	2175.56
	KENWORTH	T450 W	CUMMINS	M11	IZQUIERDA	3187858	2175.56
	KENWORTH	T600	CUMMINS	M11	IZQUIERDA	3187858	2175.56
	KENWORTH	T600B	CUMMINS	M11	IZQUIERDA	3187858	2175.56
	KENWORTH	T800	CUMMINS	M11	IZQUIERDA	3187858	2175.56
	KENWORTH	T800B	CUMMINS	M11	IZQUIERDA	3187858	2175.56
	KENWORTH	T800B	CUMMINS	M11	IZQUIERDA	3187858	2175.56
	KENWORTH	T800B SH	CUMMINS	M11	IZQUIERDA	3187858	2175.56
	KENWORTH	W900	CUMMINS	M11	IZQUIERDA	3187858	2175.56
KENWORTH	W924	CUMMINS	M11	IZQUIERDA	3187858	2175.56	
KENWORTH	T2000	CUMMINS	M11	IZQUIERDA	3187858	2175.56	
MASA VOLVO	BUSSCAR	CUMMINS	M11	IZQUIERDA	3187858	2175.56	
MASA VOLVO	HALCON	CUMMINS	M11	IZQUIERDA	3187858	2175.56	
MASA VOLVO	JAGUAR	CUMMINS	M11	IZQUIERDA	3187858	2175.56	

NUMERO DE PARTE GATES	VEHICULO	MODELO	MOTOR	SERIE	ROTACION	ORIGINAL NUMERO	PRESION PSI
 BDH-7922-A	DINA	43316070	CUMMINS	6BTAA	IZQUIERDA	226H050040	2364.12
	DINA	433	CUMMINS	155	IZQUIERDA	226H050040	2364.12
	DINA	533 G3	CUMMINS	155	IZQUIERDA	226H050040	2364.12
	DINA	531	CUMMINS	155	IZQUIERDA	226H050040	2364.12
	DINA	532 J	CUMMINS	155	IZQUIERDA	226H050040	2364.12
	DINA	751 MULT	CUMMINS	DT 530	IZQUIERDA	226H050040	2364.12
	DINA	751 MULT	CUMMINS	DT 530	IZQUIERDA	226H050040	2364.12
	DINA	7400 240	CUMMINS	DT 530	IZQUIERDA	226H050040	2364.12
	DINA	7400 240	CUMMINS	DT 530	IZQUIERDA	226H050040	2364.12
	KENWORTH	T450 W	CUMMINS	L10	IZQUIERDA	226H050040	2364.12
	KENWORTH	T600B	CUMMINS	L10	IZQUIERDA	226H050040	2364.12

NUMERO DE PARTE GATES	VEHICULO	MODELO	MOTOR	SERIE	ROTACION	ORIGINAL NUMERO	PRESION PSI
 BDH-7554-A	DINA	43316070	CUMMINS	6BTAA	DERECHA	226H050030	2364.12
	DINA	650 19570	CUMMINS	ISB	DERECHA	226H050030	2364.12
	DINA	D 9 CAB OVER	CUMMINS	ISB	DERECHA	226H050030	2364.12
	DINA	D 12 CAB OVER	CUMMINS	ISB	DERECHA	226H050030	2364.12
	FORD	F 800	CUMMINS	6BTAA	DERECHA	226H050030	2364.12
	FREIGHTLINER	FC 70	CUMMINS	ISB	DERECHA	14 12608 000	2364.12
	FREIGHTLINER	FC 80	CUMMINS	ISB	DERECHA	14 12608 000	2364.12
	FREIGHTLINER	FL 60	CUMMINS	ISB	DERECHA	14 12608 000	2364.12
	FREIGHTLINER	FL 70	CUMMINS	ISB	DERECHA	14 12608 000	2364.12
	FREIGHTLINER	FS 65	CUMMINS	ISB	DERECHA	14 12608 000	2364.12
	KENWORTH	T300	CUMMINS	ISB	DERECHA	226H050030	2364.12





UNIDADES DE REFRIGERACION

MARCA	UNIDAD DE REFRIGERACION	APLICACIÓN	No. OEM	PARTE GATES	EQUIVALENCIA
Thermo King	B1	Transmisión -	78280		3VX450
Thermo King	C	Generador -		8389 GS	9385
Thermo King	CA	Generador -		8389 GS	9385
Thermo King	CBCI	Compresor C/York o Sanden Compr.	78733		5536
Thermo King	CB-I	Compresor -	78544		AX42
Thermo King	CB-II	Compresor -	78272	8380 GS	9380
Thermo King	CB-III	Compresor -	78544		AX42
Thermo King	CG	Generador -	78232	8345 GS	9341
Thermo King	CG	Compresor -	78267	8350 GS	9350
Thermo King	CG	Motor C/Motor Eléctrico	78244	8404 GS	9400
Thermo King	CGS1250	Ventilador -	78297		5516
Thermo King	CM	Generador -		8400 GS	9395
Thermo King	Crown 500	Ventilador -	78322		5524
Thermo King	Crown 500	Alternador -	78232	8345 GS	9341
Thermo King	D1 Series	Alternador C/35A. Alt.	78511		AX37
Thermo King	D1 Series	B.A. & Alternador C/125A. Alt.	78459		AX46
Thermo King	D2M2	Alternador -	78285	8473 GS	9470
Thermo King	D2M2	Compresor -	78385		B59
Thermo King	D3 Series	B.A. & Alternador -	78459		AX46
Thermo King	D4M1	Alternador -	78285	8473 GS	9470
Thermo King	D4M1	Compresor -	78385		B59
Thermo King	FB2	Alternador -	78317	8404 GS	9400
Thermo King	FB2	B.A. -	78289	8324 GS	9319
Thermo King	FB2	Generador -	71242	8290 GS	9290
Thermo King	FB2-M5	Alternador -	78317	8404 GS	9400
Thermo King	FB2-M5	B.A. -	78289	8324 GS	9319
Thermo King	FB2-M5	Generador -	71242	8290 GS	9290
Thermo King	GA	Starter -	78195	8334 GS	9330
Thermo King	GL	Ventilador & Compresor -			BX90
Thermo King	HA	Transmisión -	78144		A66
Thermo King	HK 100	B.A. & Alternador -	78272	8380 GS	9380
Thermo King	HK 30	B.A. & Alternador -	78272	8380 GS	9380
Thermo King	HK 60	B.A. & Alternador -	78272	8380 GS	9380
Thermo King	HM	Transmisión -	78144		A66
Thermo King	J	Compresor -	78164	8350 GS	9350
Thermo King	JD-I 30	B.A. -	78679		9279
Thermo King	JD-I 50	B.A. -	78272	8380 GS	9380
Thermo King	KD-I	Ventilador -	78498		AX64
Thermo King	KD-I	B.A. Sin Alt.		8313 GS	9313
Thermo King	KD-I	B.A. & Alternador -	78434	8445 GS	9440
Thermo King	KD-I	Compresor C/Motor de reserva	78341		5521
Thermo King	KD-II	Ventilador - Right Side -			3V315
Thermo King	KD-II	Ventilador & Alternador - Left Side -	78684		5508
Thermo King	KD-II	B.A. -			9279
Thermo King	KD-II	Motor Eléctrico a Compresor Mar. 1988 & Anteriores	78689		5529
Thermo King	KD-II	Evap. Ventilador & Alternador -	78700		3V300
Thermo King	KD-II	Motor a Compresor -	78688		5502
Thermo King	KL 10	Ventilador & Compresor -	78129		BX90
Thermo King	KL 20	Ventilador & Compresor -	78173		BX55
Thermo King	KL 30	Ventilador & Compresor -	78129		BX90
Thermo King	KL 40	Ventilador & Compresor -	78129		BX90
Thermo King	KL 40S	Ventilador & Compresor -	78129		BX90
Thermo King	KL 50	Ventilador & Compresor -	78173		BX55
Thermo King	KL 62	Ventilador -	78172		BX82
Thermo King	KL 62	Ventilador & Compresor C/Fase única	78173		BX55
Thermo King	KLA	Ventilador -	78172		BX82
Thermo King	KLA	Alternador -	78212		B48
Thermo King	KR	Compresor -	78205		B58
Thermo King	LC	Motor -	78238		B68
Thermo King	LND 30	Ventilador & Alternador -	78608		B71
Thermo King	LND 30	B.A. -	78513	8305 GS	9305
Thermo King	LND 30	Polea Loca a Ventilador Shaft -	78606		B30
Thermo King	LND 30	Clutch -	78628		BX50





MASTER SERVICIO PESADO 2014

UNIDADES DE REFRIGERACION

MARCA	UNIDAD DE REFRIGERACION	APLICACIÓN	No. OEM	PARTE GATES	EQUIVALENCIA
Thermo King	LND 30	Motor a Polea Loca C/Doble banda	78669		5515
Thermo King	LND 30	Motor a Polea Loca C/Banda simple	78607		B81
Thermo King	LND 30 PEG	Ventilador & Alternador -	78608		B71
Thermo King	LND 30 PEG	B.A. -	78513	8305 GS	9305
Thermo King	LND 30 PEG	Polea Loca -	78606		B30
Thermo King	LND 30 PEG	Motor a Polea Loca -	78607		B81
Thermo King	LND 50	Ventilador - de Alternador -	78626		5531
Thermo King	LND 50	Ventilador - de Polea Loca -	78671		5510
Thermo King	LND 50	B.A. C/31" Banda O.C.		8305 GS	9305
Thermo King	LND 50	B.A. C/32" Banda O.C.		8313 GS	9313
Thermo King	LND 50	Compresor -	78628		BX50
Thermo King	LND 50	Motor a Polea Loca - Ventilador -	78649		5538
Thermo King	LND 50 PEG	Ventilador & Alternador -	78626		5531
Thermo King	LND 50 PEG	B.A. -	78513	8305 GS	9305
Thermo King	LND 50 PEG	Motor a Polea Loca -	78649		5538
Thermo King	LR	Ventilador & Alternador -	78506		5509
Thermo King	LR	B.A. -	78513	8305 GS	9305
Thermo King	LR	Transmisión -	78518		5500
Thermo King	LR	Motor Eléctrico C/220/380V., 50 Hz Mtr.			5513
Thermo King	LR	Motor Eléctrico C/230/460V., 60 Hz Mtr.			5511
Thermo King	LR-I	Alternador -	78518		5509
Thermo King	LR-I	B.A. C/31" Banda O.C.		8305 GS	9305
Thermo King	LR-I	B.A. C/32" Banda O.C.		8313 GS	9313
Thermo King	LR-I	Motor Eléctrico a Compresor Mtr. No. 4640C44H02	78509		5511
Thermo King	LR-I	Motor Eléctrico a Compresor Mtr. No. 4107D31H02	78512		5513
Thermo King	LR-I	Motor a Compresor -	78518		5500
Thermo King	M13	Ventilador -	78214		5525
Thermo King	M13	Alternador -	78232	8345 GS	9341
Thermo King	M15	Ventilador -	78214		5525
Thermo King	M15	Alternador -	78232	8345 GS	9341
Thermo King	M22	Compresor -	78239	8533 GS	9530
Thermo King	MD-I	Alternador -	78561		5519
Thermo King	MD-I	B.A. & Alternador C/2-Sistema de polea	78513	8305 GS	9305
Thermo King	MD-I	B.A. & Alternador C/3-Sistema de polea	78503	PQ17430	9430
Thermo King	MD-I	Evap. Ventilador, Motor Eléctrico & Polea Loca -	78436		5520
Thermo King	MD-I	Compresor C/Motor de reserva	78436		5520
Thermo King	MD-I	Compresor - de Clutch 50D	78591		5522
Thermo King	MD-II	Alternador Sin KD-II Polea	78700		3V300
Thermo King	MD-II	Ventilador - Right Side C/KD-II Polea			3V315
Thermo King	MD-II	Ventilador & Alternador - Left Side C/KD-II Polea	78584		5508
Thermo King	MD-II	B.A. -			9279
Thermo King	MD-II	Compresor & Polea Loca Sin KD-II Polea	78688		5502
Thermo King	MD-II	Motor Eléctrico & Compresor Feb. 1988 & Anteriores	78689		5529
Thermo King	MD-II	Motor Eléctrico & Compresor Jan. 1989 & Nuevos; Sin KD-II Polea	78679		9279
Thermo King	MD-II	Evap. Ventilador & Alternador C/KD-II Polea	78700		3V300
Thermo King	MD-II	Evap. Ventilador, Alternador & Compresor Sin KD-II Polea	78684		5508
Thermo King	MD-II	Motor a Compresor C/KD-II Polea	78688		5502
Thermo King	MW	Ventilador -	78197	8515 GS	9510
Thermo King	MW	Generador -	78111	8371 GS	9370
Thermo King	MWC 10	Alternador -	78232	8345 GS	9341
Thermo King	MWC 20	Alternador -	78265	8300 GS	9300
Thermo King	MWC 30	Alternador -	78232	8345 GS	9341
Thermo King	MWC 40	Alternador -	78265	8300 GS	9300
Thermo King	MWC 50	Alternador -	78265	8300 GS	9300
Thermo King	MWCL 25	Transmisión -	78112		6234
Thermo King	MWCT	Transmisión -	78112		6234
Thermo King	NFD	Generador -	78204	8484 GS	9480
Thermo King	NSD1-1012	B.A. & Alternador -	78397		A43
Thermo King	NWD	Ventilador Nuevo Diseño	78278		5524
Thermo King	NWD	Alternador Nuevo Diseño	78272	8380 GS	9380
Thermo King	NWD	B.A. Nuevo Diseño	78275	8450 GS	9447
Thermo King	NWD	B.A. & Generador Diseño Anterior	78204	8484 GS	9480
Thermo King	NWD	Transmisión Ser. No. 101 hasta 126	78202		BX128





MASTER SERVICIO PESADO 2014

UNIDADES DE REFRIGERACION

MARCA	UNIDAD DE REFRIGERACION	APLICACIÓN	No. OEM	PARTE GATES	EQUIVALENCIA
Thermo King	NWD	Transmisión Ser. No. 127 hasta 206	78213		BX124
Thermo King	NWD (Super & Crown)	Alternador -		8345 GS	9341
Thermo King	NWD (Super & Crown)	B.A. & Alternador -		PQ17420	9420
Thermo King	NWD 30 3000	Ventilador & Polea Loca -	78278		5524
Thermo King	NWD 30 3000	Alternador -	78272	8380 GS	9380
Thermo King	NWD 30 3000	B.A. -	78315		9279
Thermo King	NWD 30 3005	B.A. -	78336	8290 GS	9290
Thermo King	NWD 30 3005	Alternador -	78272	8380 GS	9380
Thermo King	NWD 30 3006	Alternador -	78232	8345 GS	9341
Thermo King	NWD 30 3100 Series	Ventilador & Polea Loca -	78278		5524
Thermo King	NWD 30 3100 Series	Alternador -	78272	8380 GS	9380
Thermo King	NWD 30 3100 Series	Alternador a B.A. -	78336	8290 GS	9290
Thermo King	NWD 30 AM4	Alternador -	78110		A45
Thermo King	NWD 30 AM6	Alternador -	78110		A45
Thermo King	NWD 30 AM7	Alternador -	78137		BX55
Thermo King	NWD 30 M100	Ventilador & Polea Loca -	78278		5524
Thermo King	NWD 30 M100	Alternador -	78272	8380 GS	9380
Thermo King	NWD 30 M100	B.A. -	78315		9279
Thermo King	NWD 30 M10A	Ventilador C/115" Banda O.C.	78241		BX112
Thermo King	NWD 30 M10A	B.A. & Generador -	78204	8484 GS	9480
Thermo King	NWD 30 M10A	Transmisión Diseño Anterior	78241		BX112
Thermo King	NWD 30 M1212	Ventilador & Polea Loca -	78278		5524
Thermo King	NWD 30 M1212	Alternador -	78272	8380 GS	9380
Thermo King	NWD 30 M1212	B.A. -	78315		9279
Thermo King	NWD 30 M20	Ventilador -	78241		BX112
Thermo King	NWD 30 M20	Alternador - de Motor -	78272	8380 GS	9380
Thermo King	NWD 30 M20	Alternador - de Ventilador -	78223	8580 GS	9580
Thermo King	NWD 30 M20	B.A. -	78275	8450 GS	9447
Thermo King	NWD 30 M22	Ventilador -	78241		BX112
Thermo King	NWD 30 M22	Alternador - de Motor -	78272	8380 GS	9380
Thermo King	NWD 30 M22	B.A. -	78275	8450 GS	9447
Thermo King	NWD 30 M30	Alternador - de Ventilador -	78223	8580 GS	9580
Thermo King	NWD 30 M35	Ventilador -	78241		BX112
Thermo King	NWD 30 M35	Alternador - de Motor -	78272	8380 GS	9380
Thermo King	NWD 30 M35	Alternador - de Ventilador -	78223	8580 GS	9580
Thermo King	NWD 30 M35	B.A. -	78275	8450 GS	9447
Thermo King	NWD 30 M4	Ventilador Nuevo Diseño	78214		5525
Thermo King	NWD 30 M4	Ventilador Diseño Anterior; C/115" Banda O.C.	78241		BX112
Thermo King	NWD 30 M4	Ventilador Diseño Anterior; C/118" Banda O.C.	78214		5525
Thermo King	NWD 30 M4	Alternador - de Motor. Nuevo Diseño	78272	8380 GS	9380
Thermo King	NWD 30 M4	Alternador - de Ventilador Nuevo Diseño	78223	8580 GS	9580
Thermo King	NWD 30 M4	B.A. Nuevo Diseño	78275	8450 GS	9447
Thermo King	NWD 30 M4	B.A. & Generador Diseño Anterior	78204	8484 GS	9480
Thermo King	NWD 30 M4	Transmisión Diseño Anterior	78242		BX120
Thermo King	NWD 30 M46	Ventilador -	78241		BX112
Thermo King	NWD 30 M46	Alternador - de Motor -	78272	8380 GS	9380
Thermo King	NWD 30 M46	Alternador - de Ventilador -		8573 GS	9570
Thermo King	NWD 30 M46	B.A. -	78275	8450 GS	9447
Thermo King	NWD 30 M50	B.A. -	78275	8450 GS	9447
Thermo King	NWD 35 AM6	Ventilador -	78278		5524
Thermo King	NWD 35 AM6	Alternador -	78110		AX48
Thermo King	NWD 35 AM6	B.A. & Generador -	78264	8573 GS	9570
Thermo King	NWD 35 AM7	Ventilador -	78278		5524
Thermo King	NWD 35 AM7	Alternador -	78110		AX48
Thermo King	NWD 35 AM7	B.A. & Generador -	78264	8573 GS	9570
Thermo King	NWD 35 AM8	Ventilador -	78278		5524
Thermo King	NWD 35 AM8	Alternador -	78110		AX48
Thermo King	NWD 35 AM8	B.A. & Generador -	78264	8573 GS	9570
Thermo King	NWD 35 M21	B.A. -	78275	8450 GS	9447
Thermo King	NWD 35 M21	B.A. & Alternador -	78272	8380 GS	9380
Thermo King	NWD 35 M21	B.A. & Generador -	78204	8484 GS	9480
Thermo King	NWD 35 M4	Ventilador -	78242		BX120





MASTER SERVICIO PESADO 2014

UNIDADES DE REFRIGERACION

MARCA	UNIDAD DE REFRIGERACION	APLICACIÓN	No. OEM	PARTE GATES	EQUIVALENCIA
Thermo King	NWD 35 M5	B.A. Nuevo Diseño	78275	8450 GS	9447
Thermo King	NWD 35 M5	B.A. & Alternador Nuevo Diseño	78272	8380 GS	9380
Thermo King	NWD 35 M5	B.A. & Generador Nuevo Diseño	78204	8484 GS	9480
Thermo King	NWD 50	Ventilador Diseño Anterior	78270		BX144
Thermo King	NWD 50	Ventilador Nuevo Diseño			A144
Thermo King	NWD 50	Alternador -	78362	8260 GS	9260
Thermo King	NWD 50	B.A. -	78275	8450 GS	9447
Thermo King	NWD 50	Compresor -	78368		B50
Thermo King	NWD 50 3000	Ventilador -	78287		A144
Thermo King	NWD 50 3000	Alternador -	78362	8260 GS	9260
Thermo King	NWD 50 3000	B.A. -	78328	8476 GS	9476
Thermo King	NWD 50 3000	Motor Eléctrico -			B50
Thermo King	NWD 50 3011	Ventilador -	78287		A144
Thermo King	NWD 50 3011	B.A. -	78275	8450 GS	9447
Thermo King	NWD 50 3100 Series	Ventilador & Polea Loca -	78287		A144
Thermo King	NWD 50 3100 Series	Alternador -	78362	8260 GS	9260
Thermo King	NWD 50 3100 Series	B.A. -	78328	8476 GS	9476
Thermo King	NWD 50 3100 Series	Motor Eléctrico -			B50
Thermo King	NWD 50 M207	Ventilador -	78287		A144
Thermo King	NWD 50 M207	B.A. -	78275	8450 GS	9447
Thermo King	NWD 62	B.A. -	78268	8450 GS	9451
Thermo King	NWD 62	Generador -	78255		AX46
Thermo King	NWD 62 30M5	Ventilador -	78242		BX120
Thermo King	NWD 62 50	Ventilador -	78270		BX144
Thermo King	NWD 62 50	Alternador -	78266		6825
Thermo King	NWD 62 50	B.A. -	78268	8450 GS	9451
Thermo King	NWD 622 30M10A	Ventilador -	78241		BX112
Thermo King	NWD 622 30M10A	B.A. & Generador -	78204	8484 GS	9480
Thermo King	NWD-AM1	Alternador -	78223	8580 GS	9580
Thermo King	NWD-AM1	Transmisión C/30A. Alt.	78214		5525
Thermo King	NWD-AM3	Ventilador -	78278		5524
Thermo King	NWD-AM3	Alternador Diseño Anterior; C/30A. Alt.	78223	8580 GS	9580
Thermo King	NWD-AM3	Alternador Diseño Anterior; Sin 30A. Alt.	78110		A48
Thermo King	NWD-AM3	B.A. & Alternador -	78223	8580 GS	9580
Thermo King	NWD-AM3	B.A. & Generador -	78264	8573 GS	9570
Thermo King	NWD-AM3	Transmisión C/30A. Alt.	78214		5525
Thermo King	NWD-AM4	Ventilador -	78278		5524
Thermo King	NWD-AM4	Alternador Diseño Anterior	78110		A48
Thermo King	NWD-AM4	B.A. & Alternador -	78223	8580 GS	9580
Thermo King	NWD-AM4	B.A. & Generador -	78264	8573 GS	9570
Thermo King	NWD-AM4	Transmisión Diseño Anterior; C/30A. Alt.	78214		5525
Thermo King	NWD-AM8	Alternador Nuevo Diseño	78110		A45
Thermo King	NWD-AM8	Alternador Diseño Anterior	78110		A48
Thermo King	NWE MAX	Ventilador -	78487		A48
Thermo King	NWG	Ventilador -	78230		BX100
Thermo King	NWG	B.A. -	78231		TR22386
Thermo King	RCD	Ventilador -	78287		A144
Thermo King	RCD	B.A. -	78328	8476 GS	9476
Thermo King	RD-I 30	Ventilador -	78494		5530
Thermo King	RD-I 30	Alternador -	78434	8445 GS	9440
Thermo King	RD-I 30	B.A. C/2-Sistema de polea	78513	8305 GS	9305
Thermo King	RD-I 30	B.A. C/3-Sistema de polea	78494		5530
Thermo King	RD-I 30	Compresor C/R12 Refrigerante	78495		5504
Thermo King	RD-I 30	Compresor C/R502 Refrigerante	7850		5512
Thermo King	RD-I 30	Motor Eléctrico & Compresor C/R12 Refrigerante	78436		5520
Thermo King	RD-I 30	Motor Eléctrico & Compresor C/R502 Refrigerante	78510		5503
Thermo King	RD-I 50	Ventilador -	78494		5530
Thermo King	RD-I 50	Alternador -	78434	8445 GS	9440
Thermo King	RD-I 50	B.A. C/2-Sistema de polea	78513	8305 GS	9305
Thermo King	RD-I 50	B.A. C/3-Sistema de polea	78494		5530
Thermo King	RD-I 50	Compresor C/R12 Refrigerante	78495		5504
Thermo King	RD-I 50	Compresor C/R502 Refrigerante	7850		5512
Thermo King	RD-I 50	Motor Eléctrico & Compresor C/R12 Refrigerante	78436		5520
Thermo King	RD-I 50	Motor Eléctrico & Compresor C/R502 Refrigerante	78510		5503





MASTER SERVICIO PESADO 2014

UNIDADES DE REFRIGERACION

MARCA	UNIDAD DE REFRIGERACION	APLICACIÓN	No. OEM	PARTE GATES	EQUIVALENCIA
Thermo King	RD-I SSIV	B.A. -	78513	8305 GS	9305
Thermo King	RD-I SSIV	Compresor C/R12 Refrigerante	78495		5504
Thermo King	RD-I SSIV	Compresor C/R502 Refrigerante	78500		5512
Thermo King	RD-I SSIV	Motor Eléctrico & Compresor C/R12 Refrigerante	78436		5520
Thermo King	RD-I SSIV	Motor Eléctrico & Compresor C/R502 Refrigerante	78510		5503
Thermo King	RD-I SSIV	Evap. Ventilador & Alternador -	78666		A53
Thermo King	RD-I SSIV	Evap. Ventilador, Alternador & Compresor C/R12 Refrigerante	78494		5530
Thermo King	RD-I SSIV	Evap. Ventilador, Alternador & Compresor C/R502 Refrigerante	78646		AX66
Thermo King	RD-II	B.A. & Alternador -	78434	8445 GS	9440
Thermo King	RD-II	Compresor a Ventilador -	78494		5530
Thermo King	RD-II	Motor Eléctrico a Compresor -	78510		5503
Thermo King	RD-II	Evap. Ventilador & Compresor -	78698		3VX600
Thermo King	RD-II	Evap. Ventilador & Alternador -	78666		A53
Thermo King	RD-II	Motor a Compresor C/67" Banda O.C.	78500		5512
Thermo King	RD-II	Motor a Compresor C/65" Banda O.C.	78495		5504
Thermo King	RL	Ventilador & Polea Loca -	78132		BX90
Thermo King	RL	Motor Eléctrico -	78153		B44
Thermo King	RL 20	Ventilador & Compresor -	78132		BX90
Thermo King	RL 20	Clutch -	78146	8473 GS	9470
Thermo King	RL 20	Compresor Ser. No. 876756	78146	8473 GS	9470
Thermo King	RL 20	Compresor Diseño Anterior	78153		B44
Thermo King	RL 50	Ventilador & Compresor -	78132		BX90
Thermo King	RL 50	Clutch -	78146	8473 GS	9470
Thermo King	RL 50	Compresor Ser. No. 876756	78146	8473 GS	9470
Thermo King	RL 50	Compresor Diseño Anterior	78153		B44
Thermo King	RLA	Transmisión -	78212		B48
Thermo King	RLD	Ventilador -	78320		A112
Thermo King	RLD	B.A. & Alternador -	78319	8515 GS	9510
Thermo King	ROL 30	Ventilador Ser. No. 1510 & After	78172		BX82
Thermo King	ROL 40	Ventilador -	78185		BX90
Thermo King	ROL 50	Ventilador Ser. No. 1510 & After	78172		BX82
Thermo King	RT	Blower -	78107		A68
Thermo King	SB-I 1000	Ventilador C/Salida de alto desempeño	78470		5523
Thermo King	SB-I 1000	Ventilador SIN Salida de alto desempeño	78553		5535
Thermo King	SB-I 1000	B.A. & Alternador C/47" Banda O.C.	78471	8468 GS	9465
Thermo King	SB-I 1000	B.A. & Alternador C/57" Banda O.C.	78556		AX55
Thermo King	SB-I 1200	Ventilador C/Salida de alto desempeño	78470		5523
Thermo King	SB-I 1200	Ventilador SIN Salida de alto desempeño	78553		5535
Thermo King	SB-I 1200	B.A. & Alternador C/47" Banda O.C.	78471	8468 GS	9465
Thermo King	SB-I 1200	B.A. & Alternador C/57" Banda O.C.	78556		AX55
Thermo King	SB-I 2000	Ventilador C/Salida de alto desempeño	78470		5523
Thermo King	SB-I 2000	Ventilador SIN Salida de alto desempeño	78553		5535
Thermo King	SB-I 2000	B.A. & Alternador C/47" Banda O.C.	78471	8468 GS	9465
Thermo King	SB-I 2000	B.A. & Alternador C/57" Banda O.C.	78556		AX55
Thermo King	SB-I 30	Ventilador -	78470		5523
Thermo King	SB-I 30	B.A. & Alternador -	78471	8468 GS	9465
Thermo King	SB-I 50	Ventilador & Polea Loca -	78577		B190
Thermo King	SB-I 50	Alternador -	78521		A26
Thermo King	SB-I 50	B.A. -	78267	8350 GS	9350
Thermo King	SB-I 50	Motor Eléctrico -	78535		B49
Thermo King	SB-I 5300	Ventilador & Polea Loca -	78470		5523
Thermo King	SB-I 5300	Alternador a Compresor -	78572		B60
Thermo King	SB-I 5300	B.A. & Alternador -	78471	8468 GS	9465
Thermo King	SB-II 30	Ventilador C/2-Ventilador de control de velocidad	78695		A58
Thermo King	SB-II 30	Ventilador Sin 2-Ventilador de control de velocidad	78603		BX59
Thermo King	SB-II 30	B.A. & Alternador C/37A. Alt.	78751	8468 GS	9463
Thermo King	SB-II 30	B.A. & Alternador C/65A., 72A. Alt.	78471	8468 GS	9465
Thermo King	SB-II 30	Polea Loca C/2-Ventilador de control de velocidad	78694		6884
Thermo King	SB-II 30	Polea Loca Sin 2-Ventilador de control de velocidad	78604		BX83
Thermo King	SB-II 30 1500 AC	Ventilador -	78603		BX59
Thermo King	SB-II 30 1500 AC	B.A. & Alternador Nov. 1, 1987 & Anteriores; C/37A. Alt.	78667	8476 GS	9476
Thermo King	SB-II 30 1500 AC	B.A. & Alternador Nov. 2, 1987 & Nuevos	78471	8468 GS	9465
Thermo King	SB-II 30 1500 AC	Polea Loca -	78604		BX83





MASTER SERVICIO PESADO 2014

UNIDADES DE REFRIGERACION

MARCA	UNIDAD DE REFRIGERACION	APLICACIÓN	No. OEM	PARTE GATES	EQUIVALENCIA
Thermo King	SB-II 30 1500 PEG	Ventilador -	78603		BX59
Thermo King	SB-II 30 1500 PEG	B.A. & Alternador Nov. 1, 1987 & Anteriores; C/37A. Alt.	78667	8476 GS	9476
Thermo King	SB-II 30 1500 PEG	B.A. & Alternador Nov. 2, 1987 & Nuevos	78471	8468 GS	9465
Thermo King	SB-II 30 1500 PEG	Polea Loca -	78604		BX83
Thermo King	SB-II 30 DELTA	Ventilador C/2-Ventilador de control de velocidad	78695		A58
Thermo King	SB-II 30 DELTA	B.A. & Alternador -	78751	8468 GS	9463
Thermo King	SB-II 30 DELTA	Polea Loca C/2-Ventilador de control de velocidad	78694		6884
Thermo King	SB-II 30 PEG	Ventilador C/2-Ventilador de control de velocidad	78695		A58
Thermo King	SB-II 30 PEG	Ventilador Sin 2-Ventilador de control de velocidad	78603		BX59
Thermo King	SB-II 30 PEG	B.A. & Alternador C/37A. Alt.	78751	8468 GS	9463
Thermo King	SB-II 30 PEG	B.A. & Alternador C/65A., 72A. Alt.	78471	8468 GS	9465
Thermo King	SB-II 30 PEG	Polea Loca C/2-Ventilador de control de velocidad	78694		6884
Thermo King	SB-II 30 PEG	Polea Loca Sin 2-Ventilador de control de velocidad	78604		BX83
Thermo King	SB-II 50	Ventilador & Polea Loca C/2-Speed Trans.	78731		A84
Thermo King	SB-II 50	Ventilador & Polea Loca Sin 2-Speed Trans.	78629		5537
Thermo King	SB-II 50	Alternador -	78339		A38
Thermo King	SB-II 50	B.A. -	78289	8324 GS	9319
Thermo King	SB-II 50	Compresor -	78535		B49
Thermo King	SB-II 50 TC	Ventilador & Polea Loca C/2-Speed Trans.	78731		A84
Thermo King	SB-II 50 TC	Ventilador & Polea Loca Sin 2-Speed Trans.	78629		5537
Thermo King	SB-II 50 TC	Alternador -	78339		A38
Thermo King	SB-II 50 TC	B.A. -	78289	8324 GS	9319
Thermo King	SB-II 50 TC	Compresor -	78535		B49
Thermo King	SB-II C201	Ventilador -	78603		BX59
Thermo King	SB-II C201	B.A. & Alternador C/37A. Alt.	78751	8468 GS	9463
Thermo King	SB-II C201	Polea Loca -	78604		BX83
Thermo King	SB-II Convertible	Ventilador C/Aire inverso	78637		BX61
Thermo King	SB-II Convertible	Ventilador Sin Aire inverso	78603		BX59
Thermo King	SB-II Convertible	Ventilador C/2-Ventilador de control de velocidad	78695		A58
Thermo King	SB-II Convertible	B.A. & Alternador C/37A. Alt.	78751	8468 GS	9463
Thermo King	SB-II Convertible	B.A. & Alternador C/65A., 72A. Alt.	78471	8468 GS	9465
Thermo King	SB-II Convertible	Polea Loca C/2-Ventilador de control de velocidad	78694		6884
Thermo King	SB-II Convertible	Polea Loca Sin 2-Ventilador de control de velocidad	78604		BX83
Thermo King	SB-II HP	Ventilador -	78603		BX59
Thermo King	SB-II HP	Polea Loca -	78604		BX83
Thermo King	SB-II Max	Ventilador -	78629		5537
Thermo King	SB-II Max 30	Ventilador & Polea Loca C/2-Ventilador de control de velocidad	78695		A58
Thermo King	SB-II Max 30	Ventilador & Polea Loca Sin 2-Ventilador de control de velocidad	78603		BX59
Thermo King	SB-II Max 30	B.A. & Alternador C/37A. Alt.	78751	8468 GS	9463
Thermo King	SB-II Max 30	B.A. & Alternador C/65A. Alt.	78471	8468 GS	9465
Thermo King	SB-II Max 30	Polea Loca C/2-Ventilador de control de velocidad	78694		6884
Thermo King	SB-II Max 30	Polea Loca Sin 2-Speed Trans.	78604		BX83
Thermo King	SB-II Max 50 EEC	Alternador -		8445 GS	9440
Thermo King	SB-II Max 50 EEC	B.A. -		8324 GS	9319
Thermo King	SB-II Max Plus	Ventilador -	78603		BX59
Thermo King	SB-II Max Plus	B.A. & Alternador C/37A. Alt.	787851	8468 GS	9463
Thermo King	SB-II Max Plus	Polea Loca -	78604		BX83
Thermo King	SB-II PE	Ventilador C/2-Ventilador de control de velocidad	78695		A58
Thermo King	SB-II PE	Ventilador Sin 2-Ventilador de control de velocidad	78603		BX59
Thermo King	SB-II PE	B.A. & Alternador C/37A. Alt.	78751	8468 GS	9463
Thermo King	SB-II PE	B.A. & Alternador C/65A., 72A. Alt.	78471	8468 GS	9465
Thermo King	SB-II PE	Polea Loca C/2-Ventilador de control de velocidad	78694		6884
Thermo King	SB-II PE	Polea Loca Sin 2-Ventilador de control de velocidad	78604		BX83
Thermo King	SB-II Reverse Air	Ventilador -	78637		BX61
Thermo King	SB-II Reverse Air	B.A. & Alternador C/37A. Alt.	78751	8468 GS	9463
Thermo King	SB-II Reverse Air	B.A. & Alternador C/65A., 72A. Alt.	78471	8468 GS	9465
Thermo King	SB-II Reverse Air	Polea Loca C/2-Ventilador de control de velocidad	78694		6884
Thermo King	SB-II Reverse Air	Polea Loca Sin 2-Ventilador de control de velocidad	78604		BX83
Thermo King	SB-II TC	Ventilador C/2-Ventilador de control de velocidad	78695		A58
Thermo King	SB-II TC	Ventilador Sin 2-Ventilador de control de velocidad	78603		BX59
Thermo King	SB-II TC	B.A. & Alternador C/37A. Alt.	78751	8468 GS	9463
Thermo King	SB-II TC	B.A. & Alternador C/65A., 72A. Alt.	78471	8468 GS	9465
Thermo King	SB-II TC	Polea Loca C/2-Ventilador de control de velocidad	78694		6884
Thermo King	SB-II TC	Polea Loca Sin 2-Ventilador de control de velocidad	78604		BX83





MASTER SERVICIO PESADO 2014

UNIDADES DE REFRIGERACION

MARCA	UNIDAD DE REFRIGERACION	APLICACIÓN	No. OEM	PARTE GATES	EQUIVALENCIA
Thermo King	SB-II Tracker	Ventilador C/Aire inverso	78637		BX61
Thermo King	SB-II Tracker	Ventilador Sin Aire inverso	78603		BX59
Thermo King	SB-II Tracker	Ventilador C/2-Ventilador de control de velocidad	78695		A58
Thermo King	SB-II Tracker	B.A. & Alternador C/37A. Alt.	78751	8468 GS	9463
Thermo King	SB-II Tracker	B.A. & Alternador C/65A., 72A. Alt.	78471	8468 GS	9465
Thermo King	SB-II Tracker	Polea Loca C/2-Ventilador de control de velocidad	78694		6884
Thermo King	SB-II Tracker	Polea Loca Sin 2-Ventilador de control de velocidad	78604		BX83
Thermo King	SB-III 30 TC	Ventilador -	78603		BX59
Thermo King	SB-III 30 TC	B.A. & Alternador -	78629		5537
Thermo King	SB-III 30 TC	Polea Loca -	78604		BX83
Thermo King	SB-III Max 30	Ventilador C/Sound Insulation Pkg.	78637		BX61
Thermo King	SB-III Max 30	Ventilador Sin Sound Insulation Pkg.	78603		BX59
Thermo King	SB-III Max 30	Ventilador & Polea Loca -	78629		5537
Thermo King	SB-III Max 30	B.A. & Alternador C/Sound Insulation Pkg.	78639		A48
Thermo King	SB-III Max 50	Alternador -	78434	8445 GS	9440
Thermo King	SB-III Max 50	B.A. -	78289	8324 GS	9319
Thermo King	SB-III Max 50	Compresor -	78535		B49
Thermo King	SB-III SR	Ventilador -	78603		BX59
Thermo King	SB-III SR	B.A. & Alternador Mar. 1991 & Anteriores	78751	8468 GS	9463
Thermo King	SB-III SR	Polea Loca -	78629		5537
Thermo King	SB-III SRMP Plus	Ventilador -	78603		BX59
Thermo King	SB-III SRMP Plus	B.A. & Alternador Mar. 1991 & Anteriores	78751	8468 GS	9463
Thermo King	SB-III SRMP Plus	Polea Loca -	78629		5537
Thermo King	SB-III TC Max	Ventilador -	78603		BX59
Thermo King	SB-III TC Max	B.A. & Alternador -	78751	8468 GS	9463
Thermo King	SB-III TC Max	Polea Loca -	78604		BX83
Thermo King	SD-I 1012	B.A. & Alternador C/120A. Alt.	78459	8484 GS	9480
Thermo King	SD-I 1012	B.A. & Alternador C/125A. Alt.	78397		A43
Thermo King	SD-I 1013	B.A. & Alternador C/120A. Alt.	78459	8484 GS	9480
Thermo King	SD-I 1013	B.A. & Alternador C/125A. Alt.	78397		A43
Thermo King	Sentry 30	Ventilador C/Salida de alto desempeño	78560		AX53
Thermo King	Sentry 30	Ventilador Sin Salida de alto desempeño	78556		AX55
Thermo King	Sentry 30	B.A. & Alternador C/37A. Alt.	78471	8468 GS	9465
Thermo King	Sentry 30	Polea Loca -	78555		5517
Thermo King	Sentry 30 1000	Ventilador C/Salida de alto desempeño	78560		AX53
Thermo King	Sentry 30 1000	Ventilador Sin Salida de alto desempeño	78556		AX55
Thermo King	Sentry 30 1000	B.A. & Alternador C/12A. Alt.	78267	8350 GS	9350
Thermo King	Sentry 30 1000	Polea Loca -	78555		5517
Thermo King	Sentry 30 1200	Ventilador C/Salida de alto desempeño	78560		AX53
Thermo King	Sentry 30 1200	Ventilador Sin Salida de alto desempeño	78556		AX55
Thermo King	Sentry 30 1200	B.A. & Alternador C/12A. Alt.	78267	8350 GS	9350
Thermo King	Sentry 30 1200	Polea Loca -	78555		5517
Thermo King	Sentry 30 2000	Ventilador C/Salida de alto desempeño	78560		AX53
Thermo King	Sentry 30 2000	Ventilador Sin Salida de alto desempeño	78556		AX55
Thermo King	Sentry 30 2000	B.A. & Alternador -	78471	8468 GS	9465
Thermo King	Sentry 30 2000	Polea Loca -	78555		5517
Thermo King	Sentry 30 PEG	Ventilador C/Salida de alto desempeño	78560		AX53
Thermo King	Sentry 30 PEG	Ventilador Sin Salida de alto desempeño	78556		AX55
Thermo King	Sentry 30 PEG	B.A. & Alternador C/37A. Alt.	78471	8468 GS	9465
Thermo King	Sentry 30 PEG	Polea Loca -	78555		5517
Thermo King	Sentry 50 1000	Ventilador C/Salida de alto desempeño	78560		AX53
Thermo King	Sentry 50 1000	Ventilador Sin Salida de alto desempeño	78556		AX55
Thermo King	Sentry 50 1000	Ventilador - de Alternador -	78583		A120
Thermo King	Sentry 50 1000	Alternador C/12A. Alt.	78580		2210
Thermo King	Sentry 50 1000	B.A. -	78267	8350 GS	9350
Thermo King	Sentry 50 1000	Motor Eléctrico -	78368		B50
Thermo King	Sentry 50 1000	Polea Loca -	78655		A120
Thermo King	Sentry 50 1200	Ventilador C/Salida de alto desempeño	78560		AX53
Thermo King	Sentry 50 1200	Ventilador Sin Salida de alto desempeño	78556		AX55
Thermo King	Sentry 50 1200	Ventilador - de Alternador -	78583		A120
Thermo King	Sentry 50 1200	Alternador C/12A. Alt.	78580		2210
Thermo King	Sentry 50 1200	B.A. -	78267	8350 GS	9350
Thermo King	Sentry 50 1200	Motor Eléctrico -	78368		B50
Thermo King	Sentry 50 1200	Polea Loca -	78655		A120





MASTER SERVICIO PESADO 2014

UNIDADES DE REFRIGERACION

MARCA	UNIDAD DE REFRIGERACION	APLICACIÓN	No. OEM	PARTE GATES	EQUIVALENCIA
Thermo King	Sentry 50 2000	Ventilador C/Salida de alto desempeño	78560		AX53
Thermo King	Sentry 50 2000	Ventilador Sin Salida de alto desempeño	78556		AX55
Thermo King	Sentry 50 2000	Ventilador - de Alternador -	78583		A120
Thermo King	Sentry 50 2000	Alternador C/37A. Alt.	78362	8260 GS	9260
Thermo King	Sentry 50 2000	B.A. -	78267	8350 GS	9350
Thermo King	Sentry 50 2000	Motor Eléctrico -	78368		B50
Thermo King	Sentry 50 2000	Polea Loca -	78655		A120
Thermo King	Sentry 50 Convertible	Ventilador - de Motor -	78654		6861
Thermo King	Sentry 50 Convertible	Ventilador - de Alternador -	78665		A120
Thermo King	Sentry 50 Convertible	Alternador C/13A. Alt.	78580		2210
Thermo King	Sentry 50 Convertible	Alternador C/37A. Alt.; C/Remote Mount Regulator	78266		6825
Thermo King	Sentry 50 Convertible	Alternador - Unidad de Evap. -	78497		5533
Thermo King	Sentry 50 Convertible	Polea Loca -	78656		5525
Thermo King	Sentry DI 30	Ventilador C/R12. R22 Refrigerante	78556		AX55
Thermo King	Sentry DI 30	Ventilador C/R502 Refrigerante	78560		AX53
Thermo King	Sentry DI 30	B.A. & Alternador -	78751	8468 GS	9463
Thermo King	Sentry DI 30 PE	Ventilador C/R12 Refrigerante	78556		AX55
Thermo King	Sentry DI 30 PE	Ventilador C/R502 Refrigerante	78560		AX53
Thermo King	Sentry DI 30 PE	B.A. & Alternador C/37A. Alt.; Nov. 2, 1987 & Nuevos	78751	8468 GS	9463
Thermo King	Sentry DI 30 PE	B.A. & Alternador C/65A. Alt.; Nov. 2, 1987 & Nuevos	78471	8468 GS	9465
Thermo King	Sentry DI 30 PE	B.A. & Alternador Nov. 1, 1987 & Anteriores	78667	8476 GS	9476
Thermo King	Sentry DI 30 PEG	Ventilador C/R12 Refrigerante	78556		AX55
Thermo King	Sentry DI 30 PEG	Ventilador C/R502 Refrigerante	78560		AX53
Thermo King	Sentry DI 30 PEG	B.A. & Alternador C/37A. Alt.; Nov. 2, 1987 & Nuevos	78751	8468 GS	9463
Thermo King	Sentry DI 30 PEG	B.A. & Alternador C/65A. Alt.; Nov. 2, 1987 & Nuevos	78471	8468 GS	9465
Thermo King	Sentry DI 30 PEG	B.A. & Alternador Nov. 1, 1987 & Anteriores	78667	8476 GS	9476
Thermo King	Sentry DI 50	Ventilador C/Power Tray	78655		A120
Thermo King	Sentry DI 50	Ventilador Sin Power Tray	78654		6861
Thermo King	Sentry DI 50	Alternador C/Power Tray; C/13A. Alt.	78580		2210
Thermo King	Sentry DI 50	Alternador C/Power Tray; C/37A. Alt.; C/Remote Mount Regulator	78266		6825
Thermo King	Sentry DI 50	B.A. -	78648		A29
Thermo King	Sentry DI 50	Polea Loca -	78656		5525
Thermo King	Sentry DI 50	Motor C/Power Tray	78617		5533
Thermo King	Sentry DI Convertible	Ventilador C/R502 Refrigerante	78560		AX53
Thermo King	Sentry DI Convertible	B.A. & Alternador C/37A. Alt.	78751	8468 GS	9463
Thermo King	Sentry DI Convertible	B.A. & Alternador C/65A. Alt.		8468 GS	9465
Thermo King	Sentry DI Convertible PE	Alternador -	78671		5533
Thermo King	Sentry DI TC	Ventilador -	78666		A53
Thermo King	Sentry DI TC	B.A. & Alternador C/65A. Alt.; Nov. 2, 1987 & Nuevos	78471	8468 GS	9465
Thermo King	Sentry DI TC	B.A. & Alternador Nov. 1, 1987 & Anteriores	78667	8476 GS	9476
Thermo King	Sentry TC Convertible	Ventilador C/R12 Refrigerante	78556		AX55
Thermo King	Sentry TC Convertible	Ventilador C/R502 Refrigerante	78560		AX53
Thermo King	Sentry TC Convertible	B.A. & Alternador -	78751	8468 GS	9463
Thermo King	SKF	Transmisión -	78187		A38
Thermo King	SRL	Ventilador Diseño Anterior	78132		BX90
Thermo King	SRL	Ventilador & Compresor Nuevo Diseño	78132		BX90
Thermo King	SRL	Ventilador & Polea Loca Nuevo Diseño	78132		BX90
Thermo King	SRL	Motor Eléctrico Nuevo Diseño	78153		B44
Thermo King	SRL-50	Ventilador -	78153		B44
Thermo King	SROL	Ventilador -	78261		BX82
Thermo King	SROL	Compresor -	78262		BX128
Thermo King	STB-I	Motor Eléctrico a Compresor C/1/2" Polea	78587		AX35
Thermo King	STB-II	Motor Eléctrico a Compresor C/1/2" Polea	78587		AX35
Thermo King	STB-III	Motor Eléctrico a Compresor C/1/2" Polea	78587		AX35
Thermo King	Super GS	Ventilador & Compresor -	78232	8345 GS	9341
Thermo King	Super GS	B.A. -	78339		A38
Thermo King	Super II 30	Ventilador -	78717		5506
Thermo King	Super II 30	B.A. & Alternador C/37A. Alt.	78751	8468 GS	9463
Thermo King	Super II 30	B.A. & Alternador C/65A. Alt.	78471	8468 GS	9465
Thermo King	Super II 30 Dehumidifier	Ventilador -	78717		5506
Thermo King	Super II 30 Dehumidifier	B.A. & Alternador -	78471	8468 GS	9465
Thermo King	Super II 30 Max	Ventilador -	78717		5506
Thermo King	Super II 30 Max	B.A. & Alternador -	78471	8468 GS	9465





MASTER SERVICIO PESADO 2014

UNIDADES DE REFRIGERACION

MARCA	UNIDAD DE REFRIGERACION	APLICACIÓN	No. OEM	PARTE GATES	EQUIVALENCIA
Thermo King	Super II 30 TC	Ventilador -	78717		5506
Thermo King	Super II 30 TC	B.A. & Alternador -	78471	8468 GS	9465
Thermo King	Super II 50	Alternador -	78266		6825
Thermo King	Super II 50	B.A. -	78648		A29
Thermo King	Super II 50	Clutch -	78723		BX48
Thermo King	Super MAX	Ventilador C/Aire inverso	78637		BX61
Thermo King	Super MAX	Ventilador Sin Aire inverso	78603		BX59
Thermo King	Super MAX	Ventilador C/2-Ventilador de control de velocidad	78695		A58
Thermo King	Super MAX	B.A. & Alternador C/37A. Alt.	78695		A58
Thermo King	Super MAX	Polea Loca C/2-Ventilador de control de velocidad	78694		6884
Thermo King	Super MAX	Polea Loca Sin 2-Ventilador de control de velocidad	78604		BX83
Thermo King	Super NWD	Alternador -	78232	8345 GS	9341
Thermo King	Super NWD	Generador -	78397		A43
Thermo King	Super NWD 30	Ventilador -	78278		5524
Thermo King	Super NWD 30	Ventilador - de Polea Loca -	78556		AX55
Thermo King	Super NWD 30	Alternador C/34 1/2" Banda O.C.	78232	8345 GS	9341
Thermo King	Super NWD 30	Alternador C/38 1/2" Banda O.C.	78272	8380 GS	9380
Thermo King	Super NWD 30	B.A. -	78453		2300
Thermo King	Super NWD 30 5154 BP	Ventilador & B.A. -	78241		BX112
Thermo King	Super NWD 30 5154 BP	Alternador -	78232	8345 GS	9341
Thermo King	Super NWD 30 5200 AMG	Ventilador & B.A. -	78214		5525
Thermo King	Super NWD 30 5200 AMG	Alternador C/55A. Alt.	78457	8345 GS	9341
Thermo King	Super NWD 30 5200 AMG	Alternador - Unidad de Evap. -	78497		5533
Thermo King	Super NWD 30 5237 ESP	Ventilador & B.A. -	78214		5525
Thermo King	Super NWD 30 5237 ESP	Alternador -	78467	8345 GS	9341
Thermo King	Super NWD 30 5300	Ventilador & B.A. -	78214		5525
Thermo King	Super NWD 30 5300	Alternador -	78467	8345 GS	9341
Thermo King	Super NWD 30 5300	B.A. & Alternador -	78471	8468 GS	9465
Thermo King	Super NWD 30 5300 AMG	Ventilador -	78214		5525
Thermo King	Super NWD 30 5300 AMG	Alternador - Unidad de Evap. -	78497		5533
Thermo King	Super NWD 30 5300 AMG	B.A. & Alternador C/55A. Alt.	78471	8468 GS	9465
Thermo King	Super NWD 30 PE 1000	Ventilador C/Salida de alto desempeño	78214		5525
Thermo King	Super NWD 30 PE 1000	Ventilador Sin Salida de alto desempeño	78556		AX55
Thermo King	Super NWD 30 PE 1000	Alternador - Unidad de Evap. -	78497		5533
Thermo King	Super NWD 30 PE 1000	B.A. & Alternador -		8468 GS	9465
Thermo King	Super NWD 30 PE 1000	Polea Loca -	78557		5518
Thermo King	Super NWD 30 PE 1200	Ventilador C/Salida de alto desempeño	78214		5525
Thermo King	Super NWD 30 PE 1200	Ventilador Sin Salida de alto desempeño	78556		AX55
Thermo King	Super NWD 30 PE 1200	Alternador - Unidad de Evap. -	78497		5533
Thermo King	Super NWD 30 PE 1200	B.A. & Alternador -		8468 GS	9465
Thermo King	Super NWD 30 PE 1200	Polea Loca -	78557		5518
Thermo King	Super NWD 30 PE 5000	Ventilador & B.A. -	78214		5525
Thermo King	Super NWD 30 PE 5000	Alternador -	78467	8345 GS	9341
Thermo King	Super NWD 30 PE 5100	Ventilador & B.A. -	78214		5525
Thermo King	Super NWD 30 PE 5100	Alternador -	78467	8345 GS	9341
Thermo King	Super NWD 30 PE 5200	Ventilador & B.A. -	78214		5525
Thermo King	Super NWD 30 PE 5200	Alternador -	78467	8345 GS	9341
Thermo King	Super NWD 50	Ventilador -	78287		A144
Thermo King	Super NWD 50	Ventilador - de Alternador -	78287		A144
Thermo King	Super NWD 50	Alternador -	78362	8260 GS	9260
Thermo King	Super NWD 50	B.A. -	78328	8476 GS	9476
Thermo King	Super NWD 50	Motor Eléctrico -	78368		B50
Thermo King	Super NWD 50 5000	Ventilador -	78287		A144
Thermo King	Super NWD 50 5000	Alternador -	78362	8260 GS	9260
Thermo King	Super NWD 50 5000	B.A. & Polea Loca -	78339		A38
Thermo King	Super NWD 50 5000	Motor Eléctrico -	78368		B50
Thermo King	Super NWD 50 5100	Ventilador -	78287		A144
Thermo King	Super NWD 50 5100	Alternador -	78362	8260 GS	9260
Thermo King	Super NWD 50 5100	B.A. & Polea Loca -	78339		A38
Thermo King	Super NWD 50 5100	Motor Eléctrico -	78368		B50
Thermo King	Super NWD 50 5200	Ventilador C/Power Tray	78655		A120
Thermo King	Super NWD 50 5200	Ventilador Sin Power Tray	78287		A144
Thermo King	Super NWD 50 5200	Alternador C/Power Tray; C/13A. Alt.	78580		2210





MASTER SERVICIO PESADO 2014

UNIDADES DE REFRIGERACION

MARCA	UNIDAD DE REFRIGERACION	APLICACIÓN	No. OEM	PARTE GATES	EQUIVALENCIA
Thermo King	Super NWD 50 5200	Alternador C/Power Tray; C/37A. Alt.	78362	8260 GS	9260
Thermo King	Super NWD 50 5200	Alternador Sin Power Tray	78362	8260 GS	9260
Thermo King	Super NWD 50 5200	B.A. -	78267	8350 GS	9350
Thermo King	Super NWD 50 5200	B.A. & Polea Loca -	78339		A38
Thermo King	Super NWD 50 5200	Clutch -	78368		B50
Thermo King	Super NWD 50 5200	Motor C/Power Tray	78617		5533
Thermo King	Super NWD 50 5200 AMG	Ventilador -	78287		A144
Thermo King	Super NWD 50 5200 AMG	Alternador -	78362	8260 GS	9260
Thermo King	Super NWD 50 5200 AMG	B.A. -	78267	8350 GS	9350
Thermo King	Super NWD 50 5200 AMG	Clutch -	78368		B50
Thermo King	Super NWD 50 5200 AMG	Motor C/Power Tray	78368		B50
Thermo King	Super NWD 50 5237 ESP	Ventilador -	78287		A144
Thermo King	Super NWD 50 5237 ESP	Alternador -	78362	8260 GS	9260
Thermo King	Super NWD 50 5237 ESP	B.A. & Polea Loca -	78339		A38
Thermo King	Super NWD 50 5237 ESP	Motor Eléctrico -	78368		B50
Thermo King	Super NWD 50 5300	Ventilador C/Power Tray	78655		A120
Thermo King	Super NWD 50 5300	Ventilador Sin Power Tray	78287		A144
Thermo King	Super NWD 50 5300	Alternador C/Power Tray; C/13A. Alt.	78580		2210
Thermo King	Super NWD 50 5300	Alternador C/Power Tray; C/37A. Alt.	78583		A120
Thermo King	Super NWD 50 5300	B.A. -	78267	8350 GS	9350
Thermo King	Super NWD 50 5300	Motor C/Power Tray	78368		B50
Thermo King	Super NWD 50 5300 AMG	Ventilador -	78287		A144
Thermo King	Super NWD 50 5300 AMG	Alternador -	78362	8260 GS	9260
Thermo King	Super NWD 50 5300 AMG	B.A. -	78267	8350 GS	9350
Thermo King	Super NWD 50 5300 AMG	Clutch -	78368		B50
Thermo King	Super NWD 50 5300 AMG	Motor C/Power Tray	78368		B50
Thermo King	Super NWD 50 SS TV	Ventilador -	78362	8260 GS	9260
Thermo King	Super NWD 50 SS TV	B.A. -	78339		A38
Thermo King	Super NWD 50 SS TV	Clutch -	78368		B50
Thermo King	Super NWD 5137	Ventilador & B.A. -	78214		5525
Thermo King	Super NWD 5137	Alternador -	78467	8345 GS	9341
Thermo King	Super NWD 5137 AMG	Ventilador -	78287		A144
Thermo King	Super NWD 5137 AMG	Alternador -	78362	8260 GS	9260
Thermo King	Super NWD 5137 AMG	B.A. & Polea Loca -	78339		A38
Thermo King	Super NWD 5137 AMG	Motor Eléctrico -	78368		B50
Thermo King	Super NWD LR	Ventilador & Alternador -			5509
Thermo King	Super NWD LR	Motor Eléctrico a Compresor Mtr. No. 4640C44H02	78509		5511
Thermo King	Super NWD LR	Motor Eléctrico a Compresor Mtr. No. 4107D31H002	78512		5513
Thermo King	Super NWD LR	Motor a Compresor -	78518		5500
Thermo King	Super XMT	Ventilador -	78339		A38
Thermo King	Super XMT	Alternador -	78232	8345 GS	9341
Thermo King	Super XMT	Compresor -	78340		B46
Thermo King	T3M43	Compresor -	97609500011		5539
Thermo King	TD	B.A. -	78513	8305 GS	9305
Thermo King	TD	Motor Eléctrico a Compresor -	78436		5520
Thermo King	TD	Evap. Ventilador, Alternador & Compresor -	78494		5530
Thermo King	TD	Motor a Compresor -	78495		5504
Thermo King	TD-II	Motor Eléctrico a Compresor C/R12 Refrigerante	78510		5503
Thermo King	TD-II	Evap. Ventilador & Compresor -	78484		5508
Thermo King	TD-II	Evap. Ventilador & Alternador -	78766		3VX250
Thermo King	TD-II	Motor a Compresor -	78500		5512
Thermo King	TWD	Ventilador -	78448		2640
Thermo King	TWD	Alternador -	78453		2300
Thermo King	TWD	B.A. -	78324	8395 GS	9390
Thermo King	TWD	Compresor -	78446		B69
Thermo King	TWD	Clutch -	78447		B45
Thermo King	UK	Alternador -	78240		TR22588
Thermo King	US	Alternador -	78168		TR22508
Thermo King	US	Compresor -	78173		BX55
Thermo King	US-50	Alternador -	78168		TR22508
Thermo King	US-50	Compresor -	78177		BX55
Thermo King	UWD	Ventilador, Alternador & B.A. -	78466		5527
Thermo King	UWD	Alternador -	78331		2410





MASTER SERVICIO PESADO 2014

UNIDADES DE REFRIGERACION

MARCA	UNIDAD DE REFRIGERACION	APLICACIÓN	No. OEM	PARTE GATES	EQUIVALENCIA
Thermo King	UWD	Generador Ser. No. 2565 & Before	78222	8404 GS	9400
Thermo King	UWD	Generador Ser. No. 2566 & After	78224	PQ17430	9430
Thermo King	UWTD	Ventilador, Alternador & B.A. -	78466		5527
Thermo King	UWTD	Alternador -	78222	8404 GS	9400
Thermo King	Windjammer 500	Ventilador -	78428		5526
Thermo King	Windjammer 500	Alternador -	78429	PQ17420	9420
Thermo King	XKL 10	Ventilador -	78301		B86
Thermo King	XKL 10	Compresor -	78156		B62
Thermo King	XKL 10LT	Ventilador -	78301		B86
Thermo King	XKL 10LT	Compresor -	78156		B62
Thermo King	XKL 20	Compresor -	78308		B90
Thermo King	XKL 20LT	Ventilador -	78301		B86
Thermo King	XKL 20LT	Compresor -	78308		B90
Thermo King	XKL 30	Ventilador -	78301		B86
Thermo King	XKL 30	Compresor -	78156		B62
Thermo King	XKL 30LT	Ventilador -	78301		B86
Thermo King	XKL 30LT	Compresor -	78156		B62
Thermo King	XKL 50	Compresor -	78308		B90
Thermo King	XKL 50LT	Ventilador -	78301		B86
Thermo King	XKL 50LT	Compresor -	78308		B90
Thermo King	XKW	Ventilador -	78376		3VX425
Thermo King	XKW	Compresor -	78346		3V560
Thermo King	XMD	Ventilador -	78339		A38
Thermo King	XMD	Alternador -	78449	6375 GS	7375
Thermo King	XMD	B.A. -	78444	8350 GS	9350
Thermo King	XMD	Compresor -	78340		B46
Thermo King	XMD	Evap. Ventilador & Polea Loca C/R12 Refrigerante	78436		5520
Thermo King	XMD	Evap. Ventilador & Polea Loca C/R502 Refrigerante	78485		5500
Thermo King	XMD	Motor a Compresor C/R12 Refrigerante	78432		5522
Thermo King	XMD 30	Alternador -	78449	6375 GS	7375
Thermo King	XMD 30	B.A. -	78444	8350 GS	9350
Thermo King	XMD 30	Motor a Ventilador & Compresor -	78436		5520
Thermo King	XMD 50	Alternador -	78449	6375 GS	7375
Thermo King	XMD 50	B.A. -	78444	8350 GS	9350
Thermo King	XMD 50	Motor a Ventilador & Compresor -	78436		5520
Thermo King	XMD 50D	Ventilador -	78339		A38
Thermo King	XMD 50D	Alternador -	78232	8345 GS	9341
Thermo King	XMD 50D	Compresor -	78340		B46
Thermo King	XMD-I	B.A. -	78444	8350 GS	9350
Thermo King	XMT	Alternador & Compresor C/Aenld Mtr.	78232	8345 GS	9341
Thermo King	XMT	Motor Eléctrico & Compresor -	78340		B46
Thermo King	XMT	Evap. Ventilador & Polea Loca -	78339		A38
Thermo King	XMT	Motor a Compresor C/Aenld Mtr.	78341		5521
Thermo King	XMT	Motor a Compresor C/OH160 Mtr.	78436		5520
Thermo King	XNWD	Ventilador -	78428		5526
Thermo King	XNWD	Alternador -	78429	PQ17420	9420
Thermo King	XNWD 30	Ventilador -	78428		5526
Thermo King	XNWD 30	Alternador -	78429	PQ17420	9420
Thermo King	XNWE 100	Ventilador -	78487		A48
Thermo King	XROL 10	Ventilador -	78301		B86
Thermo King	XROL 10	Compresor -	78156		B62
Thermo King	XROL 10HT	Ventilador -	78301		B86
Thermo King	XROL 10HT	Compresor -	78156		B62
Thermo King	XROL 20	Ventilador -	78301		B86
Thermo King	XROL 20	Compresor -	78308		B90
Thermo King	XROL 20HT	Ventilador -	78301		B86
Thermo King	XROL 20HT	Compresor -	78155		B93





MASTER SERVICIO PESADO 2014

UNIDADES DE REFRIGERACION

MARCA	UNIDAD DE REFRIGERACION	APLICACIÓN	No. OEM	PARTE GATES	EQUIVALENCIA
Thermo King	XROL 30	Ventilador -	78301		B86
Thermo King	XROL 30	Compresor & Clutch C/Polea No. 77-347	78302		BX64
Thermo King	XROL 30	Compresor & Clutch C/Polea No. 77-342	78156		B62
Thermo King	XROL 30 M5	Ventilador -	78301		B86
Thermo King	XROL 30 M5	Compresor & Clutch C/Polea No. 77-347	78302		BX64
Thermo King	XROL 30 M5	Compresor & Clutch C/Polea No. 77-342	78156		B62
Thermo King	XROL 30HT	Ventilador -	78301		B86
Thermo King	XROL 30HT	Compresor -	78156		B62
Thermo King	XROL 50	Ventilador -	78301		B86
Thermo King	XROL 50	Compresor & Clutch C/Polea No. 77-347	78155		B93
Thermo King	XROL 50	Compresor & Clutch C/Polea No. 77-342	78308		B89
Thermo King	XROL 50 M5	Ventilador -	78301		B86
Thermo King	XROL 50 M5	Compresor & Clutch C/Polea No. 77-347	78155		B93
Thermo King	XROL 50 M5	Compresor & Clutch C/Polea No. 77-342	78308		B89
Thermo King	XROL 50HT	Ventilador -	78301		B86
Thermo King	XROL 50HT	Compresor -	78155		B93
Thermo King	XRW	Ventilador -	78376		3VX425
Thermo King	XRW	B.A. -	78454		2285
Thermo King	XRW	Compresor -	78346		3V560
Thermo King	XRW	Motor. a Motor Eléctrico -	78342		5501
Thermo King	XRW 20D	Ventilador -	78376		3VX425
Thermo King	XRW 20D	B.A. -	78454		2285
Thermo King	XRW 20D	Compresor -	78346		3V560
Thermo King	XRW 20D	Motor. a Motor Eléctrico -	78342		5501
Thermo King	XRWL	Ventilador -	78376		3VX425
Thermo King	XRWL	B.A. -	78454		2285
Thermo King	XRWL	Compresor -	78346		3V560
Thermo King	XRWL	Motor. a Motor Eléctrico -	78342		5501
Thermo King	XUK 50 M4	Alternador -	78333		3490
Thermo King	XUK 50 M4	Compresor -	78137		BX55

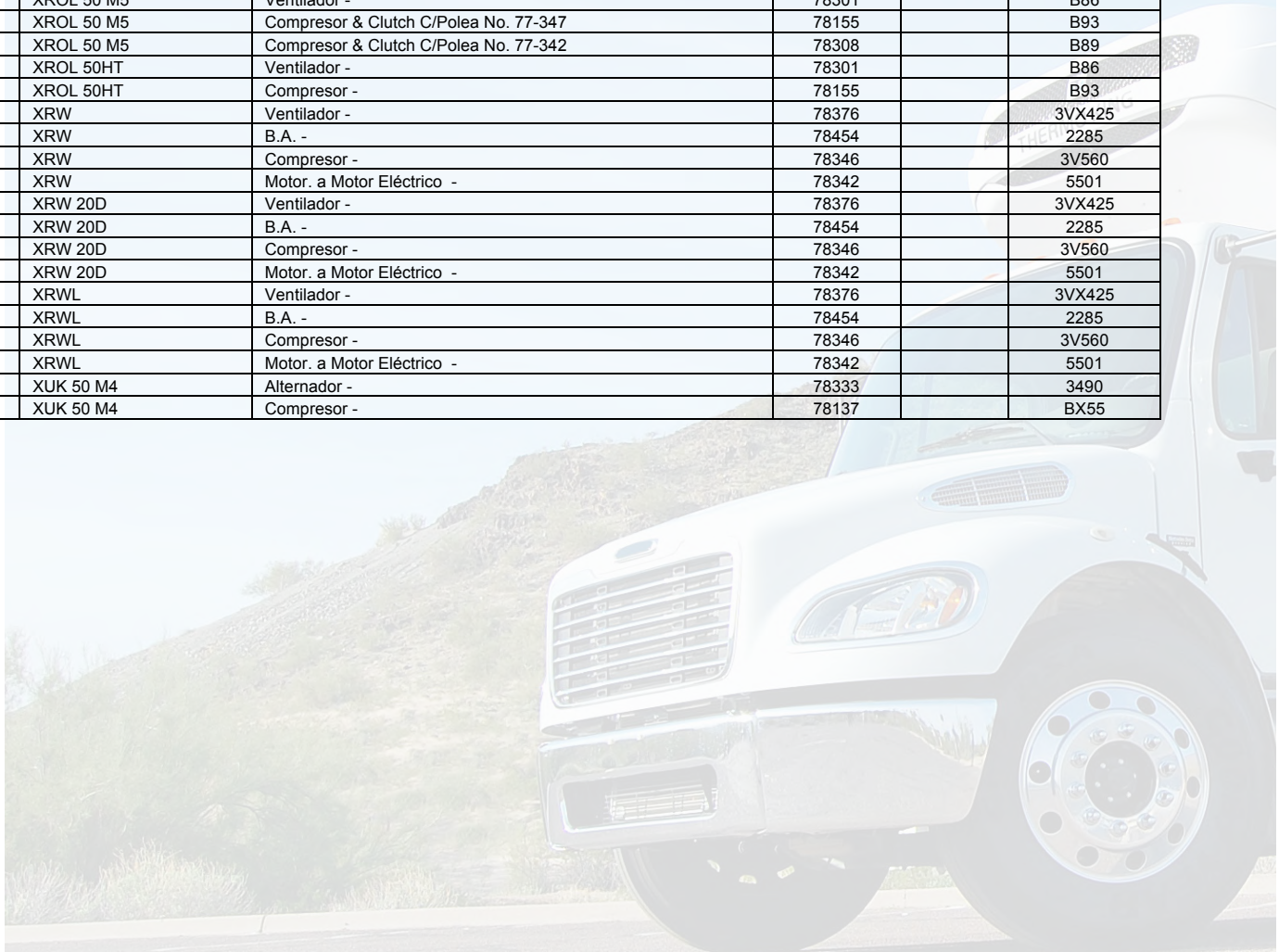



MASTER SERVICIO PESADO 2014

CHEVROLET

C4500

CHEVROLET



CHEVROLET

C4500

GM V8 8.1 L

2008

BANDA-ALT-DH-VENT-AA	K060994
TENSOR-ALT-DH-VENT-AA	38258
MANGUERA INFERIOR-	22770
MANGUERA SUPERIOR-	22769
POLEA-	38001
POLEA DEL TENSOR-	38006

2007

POLEA-S/AA	38008
MANGUERA SUPERIOR-MOTOR A RAD.	22769
MANGUERA INFERIOR-MOTOR A RAD	22770
POLEA-MOTOR	38001
TENSOR-MOTOR	38258
BANDA-ALT-DH-VENT-AA C/ALT 150A	K060994
BANDA-ALT-DH-VENT-AA C/ALT 105A	K061140
BANDA-ALT-DH-VENT C/ALT 150A	K060910
BANDA-ALT-DH-VENT C/ALT 105A	K061058
POLEA DEL TENSOR-	38006

2006

POLEA-S/AA	38001
POLEA-S/AA	38008
MANGUERA SUPERIOR-MOTOR A RAD.	22769
MANGUERA INFERIOR-MOTOR A RAD	22770
TENSOR-MOTOR	38258
POLEA-C/AA	38001
BANDA-ALT-DH-VENT-S/AA, C/DOBLE ALT 105A	K061058
BANDA-ALT-DH-VENT-AA C/UN ALT 150A	K060994
POLEA DEL TENSOR-	38006

2005

POLEA-S/AA	38001
POLEA-S/AA	38008
MANGUERA SUPERIOR-MOTOR A RAD.	22769
MANGUERA INFERIOR-MOTOR A RAD	22770
TENSOR-MOTOR	38258
POLEA-C/AA	38001
BANDA-ALT-DH-VENT-S/AA, C/DOBLE ALT 105A	K061058
BANDA-ALT-DH-VENT-S/AA, C/ALT 105A	K060905

BANDA-ALT-DH-VENT-AA-C/DOBLE ALT 105A	K061140
BANDA-ALT-DH-VENT-AA C/UN ALT 150A	K060994
BANDA-ALT-DH-VENT-AA C/ALT 105A	K060988
POLEA DEL TENSOR-	38006

2004

POLEA-S/AA	38001
POLEA-S/AA	38008
MANGUERA SUPERIOR-MOTOR A RAD.	22769
MANGUERA INFERIOR-MOTOR A RAD	22770
TENSOR-MOTOR	38258
POLEA-C/AA	38001
BANDA-ALT-DH-VENT-S/AA, C/DOBLE ALT 105A	K061058
BANDA-ALT-DH-VENT-S/AA, C/ALT 105A	K060905
BANDA-ALT-DH-VENT-AA-C/DOBLE ALT 105A	K061140
BANDA-ALT-DH-VENT-AA C/UN ALT 150A	K060994
BANDA-ALT-DH-VENT-AA C/ALT 105A	K060988
POLEA DEL TENSOR-	38006

2003

POLEA-S/AA	38001
POLEA-S/AA	38008
MANGUERA SUPERIOR-MOTOR A RAD.	22769
MANGUERA INFERIOR-MOTOR A RAD	22770
TENSOR-MOTOR	38258
POLEA-C/AA	38001
BANDA-ALT-DH-VENT-S/AA, C/DOBLE ALT 105A	K061058
BANDA-ALT-DH-VENT-S/AA, C/ALT 105A	K060905
BANDA-ALT-DH-VENT-S/AA, C/ALT 105A	K060910
BANDA-ALT-DH-VENT-AA-C/DOBLE ALT 105A	K061140
BANDA-ALT-DH-VENT-AA C/UN ALT 150A	K060994
BANDA-ALT-DH-VENT-AA C/ALT 105A	K060988
POLEA DEL TENSOR-	38006

GM V8 6.6 L DIESEL

2008

TENSOR-MOTOR	38172
POLEA DEL TENSOR-	38008

2007

MANGUERA SUPERIOR-MOTOR A RAD.	22763
TENSOR-MOTOR	38172
BANDA-ALT-DH-VENT-AA-C/DOBLE ALT 105A	K061360
BANDA-ALT-DH-VENT-AA C/ALT 150A	K061195
BANDA-ALT-DH-VENT-AA C/ALT 105A	K061187
POLEA DEL TENSOR-	38008

2006



MASTER SERVICIO PESADO 2014

CHEVROLET

C4500

MANGUERA SUPERIOR-MOTOR A RAD.	22763	POLEA-S/AA	38008
MANGUERA INFERIOR-MOTOR A RAD	22771	MANGUERA SUPERIOR-MOTOR A RAD.	22769
TENSOR-MOTOR	38172	MANGUERA INFERIOR-MOTOR A RAD	22770
BANDA-ALT-DH-VENT-AA-C/DOBLE ALT 105A	K061360	POLEA-MOTOR	38001
BANDA-ALT-DH-VENT-AA C/ALT 150A	K061195	TENSOR-MOTOR	38258
BANDA-ALT-DH-VENT-AA C/ALT 105A	K061187	BANDA-ALT-DH-VENT-AA C/ALT 150A	K060994
POLEA DEL TENSOR-	38008	BANDA-ALT-DH-VENT-AA C/ALT 105A	K061140
2005		BANDA-ALT-DH-VENT C/ALT 150A	K060910
MANGUERA SUPERIOR-MOTOR A RAD.	22763	BANDA-ALT-DH-VENT C/ALT 105A	K061058
MANGUERA INFERIOR-MOTOR A RAD	22771	POLEA DEL TENSOR-	38006
TENSOR-MOTOR	38172	2006	
BANDA-ALT-DH-VENT-AA-C/DOBLE ALT 105A	K061360	POLEA-S/AA	38001
BANDA-ALT-DH-VENT-AA C/ALT 150A	K061195	POLEA-S/AA	38008
BANDA-ALT-DH-VENT-AA C/ALT 105A	K061187	MANGUERA SUPERIOR-MOTOR A RAD.	22769
POLEA DEL TENSOR-	38008	MANGUERA INFERIOR-MOTOR A RAD	22770
2004		TENSOR-MOTOR	38258
MANGUERA SUPERIOR-MOTOR A RAD.	22763	POLEA-C/AA	38001
MANGUERA INFERIOR-MOTOR A RAD	22771	BANDA-ALT-DH-VENT-S/AA, C/DOBLE ALT 105A	K061058
TENSOR-MOTOR	38172	BANDA-ALT-DH-VENT-AA C/UN ALT 150A	K060994
BANDA-ALT-DH-VENT-AA-C/DOBLE ALT 105A	K061360	POLEA DEL TENSOR-	38006
BANDA-ALT-DH-VENT-AA C/ALT 150A	K061195	2005	
BANDA-ALT-DH-VENT-AA C/ALT 105A	K061187	POLEA-S/AA	38001
POLEA DEL TENSOR-	38008	POLEA-S/AA	38008
2003		MANGUERA SUPERIOR-MOTOR A RAD.	22769
MANGUERA SUPERIOR-MOTOR A RAD.	22763	MANGUERA INFERIOR-MOTOR A RAD	22770
MANGUERA INFERIOR-MOTOR A RAD	22771	TENSOR-MOTOR	38258
TENSOR-MOTOR	38172	POLEA-C/AA	38001
BANDA-ALT-DH-VENT-AA-C/DOBLE ALT 105A	K061360	BANDA-ALT-DH-VENT-S/AA, C/DOBLE ALT 105A	K061058
BANDA-ALT-DH-VENT-AA C/ALT 150A	K061195	BANDA-ALT-DH-VENT-S/AA, C/ALT 105A	K060905
BANDA-ALT-DH-VENT-AA C/ALT 105A	K061187	BANDA-ALT-DH-VENT-AA-C/DOBLE ALT 105A	K061140
TERMOSTATO-180°	33946	BANDA-ALT-DH-VENT-AA C/UN ALT 150A	K060994
TERMOSTATO-180°	33947	BANDA-ALT-DH-VENT-AA C/ALT 105A	K060988
POLEA DEL TENSOR-	38008	POLEA DEL TENSOR-	38006
C5500		2004	
GM V8 8.1 L		POLEA-S/AA	38001
2008		POLEA-S/AA	38008
BANDA-ALT-DH-VENT-AA	K060994	MANGUERA SUPERIOR-MOTOR A RAD.	22769
TENSOR-ALT-DH-VENT-AA	38258	MANGUERA INFERIOR-MOTOR A RAD	22770
MANGUERA INFERIOR-	22770	TENSOR-MOTOR	38258
MANGUERA SUPERIOR-	22769	POLEA-C/AA	38001
POLEA-	38001	BANDA-ALT-DH-VENT-S/AA, C/DOBLE ALT 105A	K061058
POLEA DEL TENSOR-	38006	BANDA-ALT-DH-VENT-S/AA, C/ALT 105A	K060905
2007		BANDA-ALT-DH-VENT-AA-C/DOBLE ALT 105A	K061140



BANDA-ALT-DH-VENT-AA C/UN ALT 150A	K060994	GM V8 7.4 L	
BANDA-ALT-DH-VENT-AA C/ALT 105A	K060988	2000	
POLEA DEL TENSOR-	38006	BANDA-VENT-COMPRESOR	9680
2003		BANDA-VENT-AA	9476
POLEA-S/AA	38001	MANGUERA SUPERIOR-MOTOR A RAD.	22663
POLEA-S/AA	38008	MANGUERA INFERIOR-MOTOR A RAD	22135
MANGUERA SUPERIOR-MOTOR A RAD.	22769	BANDA-DH-VENT-C/FRENOS HID	9640
MANGUERA INFERIOR-MOTOR A RAD	22770	BANDA-C/DH-C/FRENOS DE AIRE	9395
TENSOR-MOTOR	38258	BANDA-C/DH	9390
POLEA-C/AA	38001	BANDA-ALT-VENT	K060660
BANDA-ALT-DH-VENT-S/AA, C/DOBLE ALT 105A	K061058	TAPÓN DE RADIADOR-(10 LBS) SIN PALANCA	31521
BANDA-ALT-DH-VENT-S/AA, C/ALT 105A	K060905	TAPÓN DE RADIADOR-(10 LBS) CON PALANCA	31537
BANDA-ALT-DH-VENT-S/AA, C/ALT 105A	K060910	TAPÓN DE ACEITE-	31099
BANDA-ALT-DH-VENT-AA-C/DOBLE ALT 105A	K061140	1999	
BANDA-ALT-DH-VENT-AA C/UN ALT 150A	K060994	BANDA-VENT-COMPRESOR	9680
BANDA-ALT-DH-VENT-AA C/ALT 105A	K060988	BANDA-VENT-AA	9476
POLEA DEL TENSOR-	38006	MANGUERA SUPERIOR-MOTOR A RAD.	22663
2002		MANGUERA INFERIOR-MOTOR A RAD	22135
BANDA-VENT-COMPRESOR	K040762	BANDA-DH-VENT-C/FRENOS HID	9640
POLEA DEL TENSOR-VENT-COMPRESOR	38006	BANDA-C/DH-C/FRENOS DE AIRE	9395
TENSOR-VENT-COMPRESOR	38261	BANDA-C/DH	9390
MANGUERA SUPERIOR-MOTOR A RAD.	22678	BANDA-ALT-VENT	K060660
MANGUERA INFERIOR-MOTOR A RAD	22679	TAPÓN DE ACEITE-	31099
BANDA-ALT-DH-VENT-AA	K071247	GM V8 7.0 L	
POLEA DEL TENSOR-ALT-DH-VENT-AA	38033	1998	
TENSOR-ALT-DH-VENT-AA	38256	BANDA-VENT-COMPRESOR	9690
BANDA-ALT-DH-VENT	K071056	BANDA-VENT-AA	9476
TAPÓN DE RADIADOR-(10 LBS) SIN PALANCA	31521	MANGUERA SUPERIOR-MOTOR A RAD.	22031
TAPÓN DE RADIADOR-(10 LBS) CON PALANCA	31537	MANGUERA SUPERIOR-MOTOR A RAD.	22136
TAPÓN DE ACEITE-	31099	MANGUERA INFERIOR-MOTOR A RAD	21987
2001		MANGUERA INFERIOR-MOTOR A RAD	22030
BANDA-VENT-COMPRESOR	K040762	BANDA-DH-VENT-C/FRENOS HID	9650
POLEA DEL TENSOR-VENT-COMPRESOR	38006	BANDA-C/DH-C/FRENOS DE AIRE	9395
TENSOR-VENT-COMPRESOR	38261	BANDA-ALT-VENT	K060672
MANGUERA SUPERIOR-MOTOR A RAD.	22678	TAPÓN DE RADIADOR-(10 LBS) SIN PALANCA	31521
MANGUERA INFERIOR-MOTOR A RAD	22679	TAPÓN DE RADIADOR-(10 LBS) CON PALANCA	31537
BANDA-ALT-DH-VENT-AA	K071247	TAPÓN DE ACEITE-	31111
POLEA DEL TENSOR-ALT-DH-VENT-AA	38033	1997	
TENSOR-ALT-DH-VENT-AA	38256	BANDA-VENT-COMPRESOR	9690
BANDA-ALT-DH-VENT	K071056	BANDA-VENT-AA	9476
TAPÓN DE RADIADOR-(10 LBS) SIN PALANCA	31521	MANGUERA SUPERIOR-MOTOR A RAD.	22031
TAPÓN DE RADIADOR-(10 LBS) CON PALANCA	31537	MANGUERA SUPERIOR-MOTOR A RAD.	22136
TAPÓN DE ACEITE-	31099	MANGUERA INFERIOR-MOTOR A RAD	21987



MANGUERA INFERIOR-MOTOR A RAD	22030	2003	MANGUERA SUPERIOR-MOTOR A RAD.	22763
MANGUERA INFERIOR-MOTOR A RAD	22135		MANGUERA INFERIOR-MOTOR A RAD	22771
BANDA-DH-VENT-C/FRENOS HID	9650		TENSOR-MOTOR	38172
BANDA-C/DH-C/FRENOS DE AIRE	9395		BANDA-ALT-DH-VENT-AA-C/DOBLE ALT 105A	K061360
BANDA-ALT-VENT	K060672		BANDA-ALT-DH-VENT-AA C/ALT 150A	K061195
TAPÓN DE RADIADOR-(10 LBS) SIN PALANCA	31521		BANDA-ALT-DH-VENT-AA C/ALT 105A	K061187
TAPÓN DE RADIADOR-(10 LBS) CON PALANCA	31537		POLEA DEL TENSOR-	38008
TAPÓN DE ACEITE-	31111			
GM V8 6.6 L DIESEL		GM V8 6.0 L		
2008		1998		
TENSOR-MOTOR	38172	BANDA-VENT-COMPRESOR		9690
POLEA DEL TENSOR-	38008	BANDA-VENT-AA		9476
2007		MANGUERA SUPERIOR-MOTOR A RAD.		22031
MANGUERA SUPERIOR-MOTOR A RAD.	22763	MANGUERA SUPERIOR-MOTOR A RAD.		22136
TENSOR-MOTOR	38172	MANGUERA INFERIOR-MOTOR A RAD		21987
BANDA-ALT-DH-VENT-AA-C/DOBLE ALT 105A	K061360	MANGUERA INFERIOR-MOTOR A RAD		22030
BANDA-ALT-DH-VENT-AA C/ALT 150A	K061195	BANDA-DH-VENT-C/FRENOS HID		9650
BANDA-ALT-DH-VENT-AA C/ALT 105A	K061187	BANDA-C/DH-C/FRENOS DE AIRE		9395
POLEA DEL TENSOR-	38008	BANDA-ALT-VENT		K060672
2006		TAPÓN DE RADIADOR-(10 LBS) SIN PALANCA		31521
MANGUERA SUPERIOR-MOTOR A RAD.	22763	TAPÓN DE RADIADOR-(10 LBS) CON PALANCA		31537
MANGUERA INFERIOR-MOTOR A RAD	22771	TAPÓN DE ACEITE-		31111
TENSOR-MOTOR	38172	1997		
BANDA-ALT-DH-VENT-AA-C/DOBLE ALT 105A	K061360	BANDA-VENT-COMPRESOR		9690
BANDA-ALT-DH-VENT-AA C/ALT 150A	K061195	BANDA-VENT-AA		9476
BANDA-ALT-DH-VENT-AA C/ALT 105A	K061187	MANGUERA SUPERIOR-MOTOR A RAD.		22031
POLEA DEL TENSOR-	38008	MANGUERA SUPERIOR-MOTOR A RAD.		22136
2005		MANGUERA INFERIOR-MOTOR A RAD		21987
MANGUERA SUPERIOR-MOTOR A RAD.	22763	MANGUERA INFERIOR-MOTOR A RAD		22030
MANGUERA INFERIOR-MOTOR A RAD	22771	MANGUERA INFERIOR-MOTOR A RAD		22135
TENSOR-MOTOR	38172	BANDA-DH-VENT-C/FRENOS HID		9650
BANDA-ALT-DH-VENT-AA-C/DOBLE ALT 105A	K061360	BANDA-C/DH-C/FRENOS DE AIRE		9395
BANDA-ALT-DH-VENT-AA C/ALT 150A	K061195	BANDA-ALT-VENT		K060672
BANDA-ALT-DH-VENT-AA C/ALT 105A	K061187	TAPÓN DE RADIADOR-(10 LBS) SIN PALANCA		31521
POLEA DEL TENSOR-	38008	TAPÓN DE RADIADOR-(10 LBS) CON PALANCA		31537
2004		TAPÓN DE ACEITE-		31111
MANGUERA SUPERIOR-MOTOR A RAD.	22763	CATERPILLAR 3126 DIESEL		
MANGUERA INFERIOR-MOTOR A RAD	22771	2002		
TENSOR-MOTOR	38172	MANGUERA SUPERIOR-MOTOR A RAD.		22032
BANDA-ALT-DH-VENT-AA-C/DOBLE ALT 105A	K061360	MANGUERA SUPERIOR-MOTOR A RAD.		22664
BANDA-ALT-DH-VENT-AA C/ALT 150A	K061195	MANGUERA INFERIOR-MOTOR A RAD		21985
BANDA-ALT-DH-VENT-AA C/ALT 105A	K061187	TENSOR-MOTOR		38509
POLEA DEL TENSOR-	38008	BANDA-BA		9341



MASTER SERVICIO PESADO 2014

CHEVROLET

C5500

BANDA-ALT-VENT-AA	K070733	MANGUERA SUPERIOR-MOTOR A RAD.	22032
BANDA-ALT-VENT	K070705	MANGUERA SUPERIOR-MOTOR A RAD.	22664
TERMOSTATO-190°	33969	MANGUERA INFERIOR-MOTOR A RAD	21985
TERMOSTATO-180°	33968	TENSOR-MOTOR	38509
TAPÓN DE RADIADOR-(10 LBS) SIN PALANCA	31521	BANDA-BA	9341
TAPÓN DE RADIADOR-(10 LBS) CON PALANCA	31537	BANDA-ALT-VENT-AA	K070733
MANGUERA DE AGUA-	30T 3/4"	BANDA-ALT-VENT	K070705
MANGUERA DE AGUA-	30T 5/8"	TERMOSTATO-190°	33969
POLEA-	36096	TERMOSTATO-180°	33968
POLEA DEL TENSOR-	36091	TAPÓN DE RADIADOR-(10 LBS) SIN PALANCA	31521
2001		TAPÓN DE RADIADOR-(10 LBS) CON PALANCA	31537
MANGUERA SUPERIOR-MOTOR A RAD.	22032	MANGUERA DE AGUA-	30T 3/4"
MANGUERA SUPERIOR-MOTOR A RAD.	22664	MANGUERA DE AGUA-	30T 5/8"
MANGUERA INFERIOR-MOTOR A RAD	21985	POLEA-	36096
TENSOR-MOTOR	38509	POLEA DEL TENSOR-	36091
BANDA-BA	9341	1998	
BANDA-ALT-VENT-AA	K070733	MANGUERA SUPERIOR-MOTOR A RAD.	22032
BANDA-ALT-VENT	K070705	MANGUERA SUPERIOR-MOTOR A RAD.	22664
TERMOSTATO-190°	33969	MANGUERA INFERIOR-MOTOR A RAD	21985
TERMOSTATO-180°	33968	TENSOR-MOTOR	38509
TAPÓN DE RADIADOR-(10 LBS) SIN PALANCA	31521	BANDA-BA	9341
TAPÓN DE RADIADOR-(10 LBS) CON PALANCA	31537	BANDA-ALT-VENT-AA	K070733
MANGUERA DE AGUA-	30T 3/4"	BANDA-ALT-VENT	K070705
MANGUERA DE AGUA-	30T 5/8"	TERMOSTATO-190°	33969
POLEA-	36096	TERMOSTATO-180°	33968
POLEA DEL TENSOR-	36091	TAPÓN DE RADIADOR-(10 LBS) SIN PALANCA	31521
2000		TAPÓN DE RADIADOR-(10 LBS) CON PALANCA	31537
MANGUERA SUPERIOR-MOTOR A RAD.	22032	MANGUERA DE AGUA-	30T 3/4"
MANGUERA SUPERIOR-MOTOR A RAD.	22664	MANGUERA DE AGUA-	30T 5/8"
MANGUERA INFERIOR-MOTOR A RAD	21985	POLEA-	36096
TENSOR-MOTOR	38509	POLEA DEL TENSOR-	36091
BANDA-BA	9341	CATERPILLAR 3116 DIESEL	
BANDA-ALT-VENT-AA	K070733	1999	
BANDA-ALT-VENT	K070705	MANGUERA SUPERIOR-MOTOR A RAD.	21989
TERMOSTATO-190°	33969	MANGUERA SUPERIOR-MOTOR A RAD.	22032
TERMOSTATO-180°	33968	MANGUERA INFERIOR-MOTOR A RAD	21985
TAPÓN DE RADIADOR-(10 LBS) SIN PALANCA	31521	TENSOR-MOTOR	38509
TAPÓN DE RADIADOR-(10 LBS) CON PALANCA	31537	BANDA-BA	9341
MANGUERA DE AGUA-	30T 3/4"	BANDA-ALT-VENT-AA	K070733
MANGUERA DE AGUA-	30T 5/8"	BANDA-ALT-VENT	K070705
POLEA-	36096	TERMOSTATO-190°	33969
POLEA DEL TENSOR-	36091	TERMOSTATO-180°	33968
1999		TAPÓN DE RADIADOR-(10 LBS) SIN PALANCA	31521



TAPÓN DE RADIADOR-(10 LBS) CON PALANCA	31537	MANGUERA SUPERIOR-	22769
POLEA DEL TENSOR-	36091	2007	
C6500		POLEA DEL TENSOR-VENT-COMPRESOR	38006
ISUZU 6HK1-TC DIESEL		MANGUERA SUPERIOR-MOTOR A RAD.	22854
2007		MANGUERA INFERIOR-MOTOR A RAD	22771
MANGUERA SUPERIOR-MOTOR A RAD.	22767	BANDA-COMPRESOR	K040745
MANGUERA INFERIOR-MOTOR A RAD	22768	TENSOR-COMPRESOR	38324
BANDA-BA-DH	TR22461	BANDA-ALT-DH-VENT-AA	K071056
BANDA-ALT-VENT-AA	K070786	POLEA DEL TENSOR-ALT-DH-VENT-AA	38033
2006		TENSOR-ALT-DH-VENT-AA	38256
MANGUERA SUPERIOR-MOTOR A RAD.	22767	BANDA-ALT-DH-VENT	K071056
MANGUERA INFERIOR-MOTOR A RAD	22768	2006	
TENSOR-MOTOR	38548	POLEA DEL TENSOR-VENT-COMPRESOR	38006
BANDA-BA-DH	TR22461	MANGUERA SUPERIOR-MOTOR A RAD.	22854
BANDA-ALT-VENT-AA	K070786	MANGUERA INFERIOR-MOTOR A RAD	22771
2005		BANDA-COMPRESOR	K040745
MANGUERA SUPERIOR-MOTOR A RAD.	22767	TENSOR-COMPRESOR	38324
MANGUERA INFERIOR-MOTOR A RAD	22768	BANDA-ALT-DH-VENT-AA	K071247
TENSOR-MOTOR	38548	POLEA DEL TENSOR-ALT-DH-VENT-AA	38033
BANDA-BA-DH	TR22461	TENSOR-ALT-DH-VENT-AA	38256
BANDA-ALT-VENT-AA	K070786	BANDA-ALT-DH-VENT	K071056
2004		2005	
MANGUERA SUPERIOR-MOTOR A RAD.	22767	POLEA DEL TENSOR-VENT-COMPRESOR	38006
MANGUERA INFERIOR-MOTOR A RAD	22768	MANGUERA SUPERIOR-MOTOR A RAD.	22854
TENSOR-MOTOR	38548	MANGUERA INFERIOR-MOTOR A RAD	22771
BANDA-BA-DH	TR22461	BANDA-COMPRESOR	K040745
BANDA-ALT-VENT-AA	K070786	TENSOR-COMPRESOR	38324
2003		BANDA-ALT-DH-VENT-AA	K071247
MANGUERA SUPERIOR-MOTOR A RAD.	22767	POLEA DEL TENSOR-ALT-DH-VENT-AA	38033
MANGUERA INFERIOR-MOTOR A RAD	22768	TENSOR-ALT-DH-VENT-AA	38256
TENSOR-MOTOR	38548	BANDA-ALT-DH-VENT	K071056
BANDA-BA-DH	TR22461	2004	
BANDA-ALT-VENT-AA	K070786	POLEA DEL TENSOR-VENT-COMPRESOR	38006
GM V8 8.1 L		MANGUERA SUPERIOR-MOTOR A RAD.	22854
2008		MANGUERA INFERIOR-MOTOR A RAD	22771
POLEA DEL TENSOR-VENT-COMPRESOR	38006	BANDA-COMPRESOR	K040745
BANDA-COMPRESOR	K040745	TENSOR-COMPRESOR	38324
TENSOR-COMPRESOR	38324	BANDA-ALT-DH-VENT-AA	K071247
BANDA-ALT-DH-VENT-AA	K071247	POLEA DEL TENSOR-ALT-DH-VENT-AA	38033
POLEA DEL TENSOR-ALT-DH-VENT-AA	38033	TENSOR-ALT-DH-VENT-AA	38256
TENSOR-ALT-DH-VENT-AA	38256	BANDA-ALT-DH-VENT	K071056
BANDA-ALT-DH-VENT	K071056	2003	
MANGUERA INFERIOR-	22770	POLEA DEL TENSOR-VENT-COMPRESOR	38006



MASTER SERVICIO PESADO 2014

CHEVROLET

C6500

MANGUERA SUPERIOR-MOTOR A RAD.	22854	BANDA-ALT-VENT	K060660
MANGUERA INFERIOR-MOTOR A RAD	22772	TAPÓN DE RADIADOR-(10 LBS) SIN PALANCA	31521
BANDA-COMPRESOR	K040745	TAPÓN DE RADIADOR-(10 LBS) CON PALANCA	31537
TENSOR-COMPRESOR	38324	TAPÓN DE ACEITE-	31099
BANDA-ALT-DH-VENT-AA	K071247	1999	
POLEA DEL TENSOR-ALT-DH-VENT-AA	38033	BANDA-VENT-COMPRESOR	9680
TENSOR-ALT-DH-VENT-AA	38256	BANDA-VENT-AA	9476
BANDA-ALT-DH-VENT	K071056	MANGUERA SUPERIOR-MOTOR A RAD.	22663
2002		MANGUERA INFERIOR-MOTOR A RAD	22135
BANDA-VENT-COMPRESOR	K040762	BANDA-DH-VENT-C/FRENOS HID	9640
POLEA DEL TENSOR-VENT-COMPRESOR	38006	BANDA-C/DH-C/FRENOS DE AIRE	9395
TENSOR-VENT-COMPRESOR	38261	BANDA-C/DH	9390
MANGUERA SUPERIOR-MOTOR A RAD.	22678	BANDA-ALT-VENT	K060660
MANGUERA INFERIOR-MOTOR A RAD	22679	TAPÓN DE RADIADOR-(10 LBS) SIN PALANCA	31521
BANDA-ALT-DH-VENT-AA	K071247	TAPÓN DE RADIADOR-(10 LBS) CON PALANCA	31537
POLEA DEL TENSOR-ALT-DH-VENT-AA	38033	TAPÓN DE ACEITE-	31099
TENSOR-ALT-DH-VENT-AA	38256	GM V8 7.0 L	
BANDA-ALT-DH-VENT	K071056	1998	
TAPÓN DE RADIADOR-(10 LBS) SIN PALANCA	31521	BANDA-VENT-COMPRESOR	9690
TAPÓN DE RADIADOR-(10 LBS) CON PALANCA	31537	BANDA-VENT-AA	9476
TAPÓN DE ACEITE-	31099	MANGUERA SUPERIOR-MOTOR A RAD.	22031
2001		MANGUERA SUPERIOR-MOTOR A RAD.	22136
BANDA-VENT-COMPRESOR	K040762	MANGUERA INFERIOR-MOTOR A RAD	21987
POLEA DEL TENSOR-VENT-COMPRESOR	38006	MANGUERA INFERIOR-MOTOR A RAD	22030
TENSOR-VENT-COMPRESOR	38261	BANDA-DH-VENT-C/FRENOS HID	9650
MANGUERA SUPERIOR-MOTOR A RAD.	22678	BANDA-C/DH-C/FRENOS DE AIRE	9395
MANGUERA INFERIOR-MOTOR A RAD	22679	BANDA-ALT-VENT	K060672
BANDA-ALT-DH-VENT-AA	K071247	TAPÓN DE RADIADOR-(10 LBS) SIN PALANCA	31521
POLEA DEL TENSOR-ALT-DH-VENT-AA	38033	TAPÓN DE RADIADOR-(10 LBS) CON PALANCA	31537
TENSOR-ALT-DH-VENT-AA	38256	TAPÓN DE ACEITE-	31111
BANDA-ALT-DH-VENT	K071056	1997	
TAPÓN DE RADIADOR-(10 LBS) SIN PALANCA	31521	BANDA-VENT-COMPRESOR	9690
TAPÓN DE RADIADOR-(10 LBS) CON PALANCA	31537	BANDA-VENT-AA	9476
TAPÓN DE ACEITE-	31099	MANGUERA SUPERIOR-MOTOR A RAD.	22031
GM V8 7.4 L		MANGUERA SUPERIOR-MOTOR A RAD.	22136
2000		MANGUERA INFERIOR-MOTOR A RAD	21987
BANDA-VENT-COMPRESOR	9680	MANGUERA INFERIOR-MOTOR A RAD	22030
BANDA-VENT-AA	9476	MANGUERA INFERIOR-MOTOR A RAD	22135
MANGUERA SUPERIOR-MOTOR A RAD.	22663	BANDA-DH-VENT-C/FRENOS HID	9650
MANGUERA INFERIOR-MOTOR A RAD	22135	BANDA-C/DH-C/FRENOS DE AIRE	9395
BANDA-DH-VENT-C/FRENOS HID	9640	BANDA-ALT-VENT	K060672
BANDA-C/DH-C/FRENOS DE AIRE	9395	TAPÓN DE RADIADOR-(10 LBS) SIN PALANCA	31521
BANDA-C/DH	9390	TAPÓN DE RADIADOR-(10 LBS) CON PALANCA	31537



TAPÓN DE ACEITE-	31111	TENSOR-ALT-VENT-AA	38586
GM V8 6.0 L		TERMOSTATO-190°	33969
1998		TERMOSTATO-180°	33968
BANDA-VENT-COMPRESOR	9690	POLEA-	36096
BANDA-VENT-AA	9476	2005	
MANGUERA SUPERIOR-MOTOR A RAD.	22031	MANGUERA SUPERIOR-MOTOR A RAD.	23087
MANGUERA SUPERIOR-MOTOR A RAD.	22136	MANGUERA SUPERIOR-MOTOR A RAD.	23099
MANGUERA INFERIOR-MOTOR A RAD	21987	MANGUERA INFERIOR-MOTOR A RAD	23088
MANGUERA INFERIOR-MOTOR A RAD	22030	BANDA-ALT-VENT-AA	K080806
BANDA-DH-VENT-C/FRENOS HID	9650	TENSOR-ALT-VENT-AA	38586
BANDA-C/DH-C/FRENOS DE AIRE	9395	TERMOSTATO-190°	33969
BANDA-ALT-VENT	K060672	TERMOSTATO-180°	33968
TAPÓN DE RADIADOR-(10 LBS) SIN PALANCA	31521	POLEA-	36096
TAPÓN DE RADIADOR-(10 LBS) CON PALANCA	31537	2004	
TAPÓN DE ACEITE-	31111	MANGUERA SUPERIOR-MOTOR A RAD.	23087
1997		MANGUERA SUPERIOR-MOTOR A RAD.	23099
BANDA-VENT-COMPRESOR	9690	MANGUERA INFERIOR-MOTOR A RAD	23088
BANDA-VENT-AA	9476	BANDA-ALT-VENT-AA	K080806
MANGUERA SUPERIOR-MOTOR A RAD.	22031	TENSOR-ALT-VENT-AA	38586
MANGUERA SUPERIOR-MOTOR A RAD.	22136	TERMOSTATO-190°	33969
MANGUERA INFERIOR-MOTOR A RAD	21987	TERMOSTATO-180°	33968
MANGUERA INFERIOR-MOTOR A RAD	22030	POLEA-	36096
MANGUERA INFERIOR-MOTOR A RAD	22135	CATERPILLAR 3126 DIESEL	
BANDA-DH-VENT-C/FRENOS HID	9650	2003	
BANDA-C/DH-C/FRENOS DE AIRE	9395	MANGUERA SUPERIOR-MOTOR A RAD.	22764
BANDA-ALT-VENT	K060672	MANGUERA SUPERIOR-MOTOR A RAD.	22765
TAPÓN DE RADIADOR-(10 LBS) SIN PALANCA	31521	MANGUERA INFERIOR-MOTOR A RAD	22766
TAPÓN DE RADIADOR-(10 LBS) CON PALANCA	31537	TENSOR-MOTOR	38557
TAPÓN DE ACEITE-	31111	BANDA-BA	9335
CATERPILLAR C7 DIESEL		BANDA-ALT-VENT-AA	K070835
2008		BANDA-ALT-VENT	K070709
TERMOSTATO-190°	33969	TERMOSTATO-190°	33969
TERMOSTATO-180°	33968	TERMOSTATO-180°	33968
2007		TAPÓN DE RADIADOR-(10 LBS) SIN PALANCA	31521
BANDA-ALT-VENT-AA	K080806	TAPÓN DE RADIADOR-(10 LBS) CON PALANCA	31537
TENSOR-ALT-VENT-AA	38586	POLEA-	36096
TERMOSTATO-190°	33969	POLEA DEL TENSOR-	36091
TERMOSTATO-180°	33968	2002	
POLEA-	36096	MANGUERA SUPERIOR-MOTOR A RAD.	22032
2006		MANGUERA SUPERIOR-MOTOR A RAD.	22664
MANGUERA SUPERIOR-MOTOR A RAD.	23087	MANGUERA INFERIOR-MOTOR A RAD	21985
MANGUERA INFERIOR-MOTOR A RAD	23088	TENSOR-MOTOR	38509
BANDA-ALT-VENT-AA	K080806	BANDA-BA	9341



MASTER SERVICIO PESADO 2014

CHEVROLET

C6500

BANDA-ALT-VENT-AA	K070733	MANGUERA SUPERIOR-MOTOR A RAD.	22032
BANDA-ALT-VENT	K070705	MANGUERA SUPERIOR-MOTOR A RAD.	22664
TERMOSTATO-190°	33969	MANGUERA INFERIOR-MOTOR A RAD	21985
TERMOSTATO-180°	33968	TENSOR-MOTOR	38509
TAPÓN DE RADIADOR-(10 LBS) SIN PALANCA	31521	BANDA-BA	9341
TAPÓN DE RADIADOR-(10 LBS) CON PALANCA	31537	BANDA-ALT-VENT-AA	K070733
MANGUERA DE AGUA-	30T 3/4"	BANDA-ALT-VENT	K070705
MANGUERA DE AGUA-	30T 5/8"	TERMOSTATO-190°	33969
POLEA-	36096	TERMOSTATO-180°	33968
POLEA DEL TENSOR-	36091	TAPÓN DE RADIADOR-(10 LBS) SIN PALANCA	31521
2001		TAPÓN DE RADIADOR-(10 LBS) CON PALANCA	31537
MANGUERA SUPERIOR-MOTOR A RAD.	22032	MANGUERA DE AGUA-	30T 3/4"
MANGUERA SUPERIOR-MOTOR A RAD.	22664	MANGUERA DE AGUA-	30T 5/8"
MANGUERA INFERIOR-MOTOR A RAD	21985	POLEA-	36096
TENSOR-MOTOR	38509	POLEA DEL TENSOR-	36091
BANDA-BA	9341	1998	
BANDA-ALT-VENT-AA	K070733	MANGUERA SUPERIOR-MOTOR A RAD.	22032
BANDA-ALT-VENT	K070705	MANGUERA SUPERIOR-MOTOR A RAD.	22664
TERMOSTATO-190°	33969	MANGUERA INFERIOR-MOTOR A RAD	21985
TERMOSTATO-180°	33968	TENSOR-MOTOR	38509
TAPÓN DE RADIADOR-(10 LBS) SIN PALANCA	31521	BANDA-BA	9341
TAPÓN DE RADIADOR-(10 LBS) CON PALANCA	31537	BANDA-ALT-VENT-AA	K070733
MANGUERA DE AGUA-	30T 3/4"	BANDA-ALT-VENT	K070705
MANGUERA DE AGUA-	30T 5/8"	TERMOSTATO-190°	33969
POLEA-	36096	TERMOSTATO-180°	33968
POLEA DEL TENSOR-	36091	TAPÓN DE RADIADOR-(10 LBS) SIN PALANCA	31521
2000		TAPÓN DE RADIADOR-(10 LBS) CON PALANCA	31537
MANGUERA SUPERIOR-MOTOR A RAD.	22032	MANGUERA DE AGUA-	30T 3/4"
MANGUERA SUPERIOR-MOTOR A RAD.	22664	MANGUERA DE AGUA-	30T 5/8"
MANGUERA INFERIOR-MOTOR A RAD	21985	POLEA-	36096
TENSOR-MOTOR	38509	POLEA DEL TENSOR-	36091
BANDA-BA	9341	CATERPILLAR 3116 DIESEL	
BANDA-ALT-VENT-AA	K070733	2000	
BANDA-ALT-VENT	K070705	MANGUERA SUPERIOR-MOTOR A RAD.	21989
TERMOSTATO-190°	33969	MANGUERA SUPERIOR-MOTOR A RAD.	22032
TERMOSTATO-180°	33968	MANGUERA INFERIOR-MOTOR A RAD	21985
TAPÓN DE RADIADOR-(10 LBS) SIN PALANCA	31521	TENSOR-MOTOR	38509
TAPÓN DE RADIADOR-(10 LBS) CON PALANCA	31537	BANDA-BA	9341
MANGUERA DE AGUA-	30T 3/4"	BANDA-ALT-VENT-AA	K070733
MANGUERA DE AGUA-	30T 5/8"	BANDA-ALT-VENT	K070705
POLEA-	36096	TERMOSTATO-190°	33969
POLEA DEL TENSOR-	36091	TERMOSTATO-180°	33968
1999		TAPÓN DE RADIADOR-(10 LBS) SIN PALANCA	31521



MASTER SERVICIO PESADO 2014

CHEVROLET

C6500

TAPÓN DE RADIADOR-(10 LBS) CON PALANCA	31537	TERMOSTATO-180°	33968
POLEA DEL TENSOR-	36091	TAPÓN DE RADIADOR-(10 LBS) SIN PALANCA	31521
1999		TAPÓN DE RADIADOR-(10 LBS) CON PALANCA	31537
MANGUERA SUPERIOR-MOTOR A RAD.	21989	POLEA DEL TENSOR-	36091
MANGUERA SUPERIOR-MOTOR A RAD.	22032	C7500	
MANGUERA INFERIOR-MOTOR A RAD	21985	ISUZU 6HK1-TC DIESEL	
TENSOR-MOTOR	38509	2007	
BANDA-BA	9341	MANGUERA SUPERIOR-MOTOR A RAD.	22767
BANDA-ALT-VENT-AA	K070733	MANGUERA INFERIOR-MOTOR A RAD	22768
BANDA-ALT-VENT	K070705	BANDA-BA-DH	TR22461
TERMOSTATO-190°	33969	BANDA-ALT-VENT-AA	K070786
TERMOSTATO-180°	33968	2006	
TAPÓN DE RADIADOR-(10 LBS) SIN PALANCA	31521	MANGUERA SUPERIOR-MOTOR A RAD.	22767
TAPÓN DE RADIADOR-(10 LBS) CON PALANCA	31537	MANGUERA INFERIOR-MOTOR A RAD	22768
POLEA DEL TENSOR-	36091	TENSOR-MOTOR	38548
1998		BANDA-BA-DH	TR22461
MANGUERA SUPERIOR-MOTOR A RAD.	21989	BANDA-ALT-VENT-AA	K070786
MANGUERA SUPERIOR-MOTOR A RAD.	22032	2005	
MANGUERA SUPERIOR-MOTOR A RAD.	22134	MANGUERA SUPERIOR-MOTOR A RAD.	22767
MANGUERA INFERIOR-MOTOR A RAD	21985	MANGUERA INFERIOR-MOTOR A RAD	22768
TENSOR-MOTOR	38509	TENSOR-MOTOR	38548
BANDA-BA	9341	BANDA-BA-DH	TR22461
BANDA-ALT-VENT-AA	K070735	BANDA-ALT-VENT-AA	K070786
BANDA-ALT-VENT-AA	K070825	2004	
BANDA-ALT-VENT	K060672	MANGUERA SUPERIOR-MOTOR A RAD.	22767
BANDA-ALT-VENT	K070705	MANGUERA INFERIOR-MOTOR A RAD	22768
TERMOSTATO-190°	33969	TENSOR-MOTOR	38548
TERMOSTATO-180°	33968	BANDA-BA-DH	TR22461
TAPÓN DE RADIADOR-(10 LBS) SIN PALANCA	31521	BANDA-ALT-VENT-AA	K070786
TAPÓN DE RADIADOR-(10 LBS) CON PALANCA	31537	2003	
POLEA DEL TENSOR-	36091	MANGUERA SUPERIOR-MOTOR A RAD.	22767
1997		MANGUERA INFERIOR-MOTOR A RAD	22768
MANGUERA SUPERIOR-MOTOR A RAD.	21989	TENSOR-MOTOR	38548
MANGUERA SUPERIOR-MOTOR A RAD.	22032	BANDA-BA-DH	TR22461
MANGUERA SUPERIOR-MOTOR A RAD.	22134	BANDA-ALT-VENT-AA	K070786
MANGUERA INFERIOR-MOTOR A RAD	21985	GM V8 8.1 L	
TENSOR-MOTOR	38509	2008	
BANDA-BA	9341	POLEA DEL TENSOR-VENT-COMPRESOR	38006
BANDA-ALT-VENT-AA	K070735	BANDA-COMPRESOR	K040745
BANDA-ALT-VENT-AA	K070825	TENSOR-COMPRESOR	38324
BANDA-ALT-VENT	K060672	BANDA-ALT-DH-VENT-AA	K071247
BANDA-ALT-VENT	K070705	POLEA DEL TENSOR-ALT-DH-VENT-AA	38033
TERMOSTATO-190°	33969	TENSOR-ALT-DH-VENT-AA	38256



MASTER SERVICIO PESADO 2014

CHEVROLET

C7500

BANDA-ALT-DH-VENT	K071056	2003	
MANGUERA INFERIOR-	22770	POLEA DEL TENSOR-VENT-COMPRESOR	38006
MANGUERA SUPERIOR-	22769	MANGUERA SUPERIOR-MOTOR A RAD.	22854
2007		MANGUERA INFERIOR-MOTOR A RAD	22772
POLEA DEL TENSOR-VENT-COMPRESOR	38006	BANDA-COMPRESOR	K040745
MANGUERA SUPERIOR-MOTOR A RAD.	22854	TENSOR-COMPRESOR	38324
MANGUERA INFERIOR-MOTOR A RAD	22771	BANDA-ALT-DH-VENT-AA	K071247
BANDA-COMPRESOR	K040745	POLEA DEL TENSOR-ALT-DH-VENT-AA	38033
TENSOR-COMPRESOR	38324	TENSOR-ALT-DH-VENT-AA	38256
BANDA-ALT-DH-VENT-AA	K071247	BANDA-ALT-DH-VENT	K071056
POLEA DEL TENSOR-ALT-DH-VENT-AA	38033	2002	
TENSOR-ALT-DH-VENT-AA	38256	BANDA-VENT-COMPRESOR	K040762
BANDA-ALT-DH-VENT	K071056	POLEA DEL TENSOR-VENT-COMPRESOR	38006
2006		TENSOR-VENT-COMPRESOR	38261
POLEA DEL TENSOR-VENT-COMPRESOR	38006	MANGUERA SUPERIOR-MOTOR A RAD.	22678
MANGUERA SUPERIOR-MOTOR A RAD.	22854	MANGUERA INFERIOR-MOTOR A RAD	22679
MANGUERA INFERIOR-MOTOR A RAD	22771	BANDA-ALT-DH-VENT-AA	K071247
BANDA-COMPRESOR	K040745	POLEA DEL TENSOR-ALT-DH-VENT-AA	38033
TENSOR-COMPRESOR	38324	TENSOR-ALT-DH-VENT-AA	38256
BANDA-ALT-DH-VENT-AA	K071247	BANDA-ALT-DH-VENT	K071056
POLEA DEL TENSOR-ALT-DH-VENT-AA	38033	TAPÓN DE RADIADOR-(10 LBS) SIN PALANCA	31521
TENSOR-ALT-DH-VENT-AA	38256	TAPÓN DE RADIADOR-(10 LBS) CON PALANCA	31537
BANDA-ALT-DH-VENT	K071056	TAPÓN DE ACEITE-	31099
2005		2001	
POLEA DEL TENSOR-VENT-COMPRESOR	38006	BANDA-VENT-COMPRESOR	K040762
MANGUERA SUPERIOR-MOTOR A RAD.	22854	POLEA DEL TENSOR-VENT-COMPRESOR	38006
MANGUERA INFERIOR-MOTOR A RAD	22771	TENSOR-VENT-COMPRESOR	38261
BANDA-COMPRESOR	K040745	MANGUERA SUPERIOR-MOTOR A RAD.	22678
TENSOR-COMPRESOR	38324	MANGUERA INFERIOR-MOTOR A RAD	22679
BANDA-ALT-DH-VENT-AA	K071247	BANDA-ALT-DH-VENT-AA	K071247
POLEA DEL TENSOR-ALT-DH-VENT-AA	38033	POLEA DEL TENSOR-ALT-DH-VENT-AA	38033
TENSOR-ALT-DH-VENT-AA	38256	TENSOR-ALT-DH-VENT-AA	38256
BANDA-ALT-DH-VENT	K071056	BANDA-ALT-DH-VENT	K071056
2004		TAPÓN DE RADIADOR-(10 LBS) SIN PALANCA	31521
POLEA DEL TENSOR-VENT-COMPRESOR	38006	TAPÓN DE RADIADOR-(10 LBS) CON PALANCA	31537
MANGUERA SUPERIOR-MOTOR A RAD.	22854	TAPÓN DE ACEITE-	31099
MANGUERA INFERIOR-MOTOR A RAD	22771	GM V8 7.4 L	
BANDA-COMPRESOR	K040745	2000	
TENSOR-COMPRESOR	38324	BANDA-VENT-COMPRESOR	9680
BANDA-ALT-DH-VENT-AA	K071247	BANDA-VENT-AA	9476
POLEA DEL TENSOR-ALT-DH-VENT-AA	38033	MANGUERA SUPERIOR-MOTOR A RAD.	22663
TENSOR-ALT-DH-VENT-AA	38256	MANGUERA INFERIOR-MOTOR A RAD	22135
BANDA-ALT-DH-VENT	K071056	BANDA-DH-VENT-C/FRENOS HID	9640



MASTER SERVICIO PESADO 2014

CHEVROLET

C7500

BANDA-C/DH-C/FRENOS DE AIRE	9395	TAPÓN DE ACEITE-	31111
BANDA-C/DH	9390	GM V8 6.0 L	
BANDA-ALT-VENT	K060660	1998	
TAPÓN DE RADIADOR-(10 LBS) SIN PALANCA	31521	BANDA-VENT-COMPRESOR	9690
TAPÓN DE RADIADOR-(10 LBS) CON PALANCA	31537	BANDA-VENT-AA	9476
TAPÓN DE ACEITE-	31099	MANGUERA SUPERIOR-MOTOR A RAD.	22031
1999		MANGUERA SUPERIOR-MOTOR A RAD.	22136
BANDA-VENT-COMPRESOR	9680	MANGUERA INFERIOR-MOTOR A RAD	21987
BANDA-VENT-AA	9476	MANGUERA INFERIOR-MOTOR A RAD	22030
MANGUERA SUPERIOR-MOTOR A RAD.	22663	BANDA-DH-VENT-C/FRENOS HID	9650
MANGUERA INFERIOR-MOTOR A RAD	22135	BANDA-C/DH-C/FRENOS DE AIRE	9395
BANDA-DH-VENT-C/FRENOS HID	9640	BANDA-ALT-VENT	K060672
BANDA-C/DH-C/FRENOS DE AIRE	9395	TAPÓN DE RADIADOR-(10 LBS) SIN PALANCA	31521
BANDA-C/DH	9390	TAPÓN DE RADIADOR-(10 LBS) CON PALANCA	31537
BANDA-ALT-VENT	K060660	TAPÓN DE ACEITE-	31111
TAPÓN DE ACEITE-	31099	1997	
GM V8 7.0 L		BANDA-VENT-COMPRESOR	9690
1998		BANDA-VENT-AA	9476
BANDA-VENT-COMPRESOR	9690	MANGUERA SUPERIOR-MOTOR A RAD.	22031
BANDA-VENT-AA	9476	MANGUERA SUPERIOR-MOTOR A RAD.	22136
MANGUERA SUPERIOR-MOTOR A RAD.	22031	MANGUERA INFERIOR-MOTOR A RAD	21987
MANGUERA SUPERIOR-MOTOR A RAD.	22136	MANGUERA INFERIOR-MOTOR A RAD	22030
MANGUERA INFERIOR-MOTOR A RAD	21987	MANGUERA INFERIOR-MOTOR A RAD	22135
MANGUERA INFERIOR-MOTOR A RAD	22030	BANDA-DH-VENT-C/FRENOS HID	9650
BANDA-DH-VENT-C/FRENOS HID	9650	BANDA-C/DH-C/FRENOS DE AIRE	9395
BANDA-C/DH-C/FRENOS DE AIRE	9395	BANDA-ALT-VENT	K060672
BANDA-ALT-VENT	K060672	TAPÓN DE RADIADOR-(10 LBS) SIN PALANCA	31521
TAPÓN DE RADIADOR-(10 LBS) SIN PALANCA	31521	TAPÓN DE RADIADOR-(10 LBS) CON PALANCA	31537
TAPÓN DE RADIADOR-(10 LBS) CON PALANCA	31537	TAPÓN DE ACEITE-	31111
TAPÓN DE ACEITE-	31111	CATERPILLAR C7 DIESEL	
1997		2008	
BANDA-VENT-COMPRESOR	9690	TERMOSTATO-190°	33969
BANDA-VENT-AA	9476	TERMOSTATO-180°	33968
MANGUERA SUPERIOR-MOTOR A RAD.	22031	2007	
MANGUERA SUPERIOR-MOTOR A RAD.	22136	BANDA-ALT-VENT-AA	K080806
MANGUERA INFERIOR-MOTOR A RAD	21987	TENSOR-ALT-VENT-AA	38586
MANGUERA INFERIOR-MOTOR A RAD	22030	TERMOSTATO-190°	33969
MANGUERA INFERIOR-MOTOR A RAD	22135	TERMOSTATO-180°	33968
BANDA-DH-VENT-C/FRENOS HID	9650	POLEA-	36096
BANDA-C/DH-C/FRENOS DE AIRE	9395	2006	
BANDA-ALT-VENT	K060672	MANGUERA SUPERIOR-MOTOR A RAD.	23087
TAPÓN DE RADIADOR-(10 LBS) SIN PALANCA	31521	MANGUERA INFERIOR-MOTOR A RAD	23088
TAPÓN DE RADIADOR-(10 LBS) CON PALANCA	31537	BANDA-ALT-VENT-AA	K080806



MASTER SERVICIO PESADO 2014

CHEVROLET

C7500

TENSOR-ALT-VENT-AA	38586	BANDA-ALT-VENT-AA	K070733
TERMOSTATO-190°	33969	BANDA-ALT-VENT	K070705
TERMOSTATO-180°	33968	TERMOSTATO-190°	33969
POLEA-	36096	TERMOSTATO-180°	33968
2005		TAPÓN DE RADIADOR-(10 LBS) SIN PALANCA	31521
MANGUERA SUPERIOR-MOTOR A RAD.	23087	TAPÓN DE RADIADOR-(10 LBS) CON PALANCA	31537
MANGUERA SUPERIOR-MOTOR A RAD.	23099	MANGUERA DE AGUA-	30T 3/4"
MANGUERA INFERIOR-MOTOR A RAD	23088	MANGUERA DE AGUA-	30T 5/8"
BANDA-ALT-VENT-AA	K080806	POLEA-	36096
TENSOR-ALT-VENT-AA	38586	POLEA DEL TENSOR-	36091
TERMOSTATO-190°	33969	2001	
TERMOSTATO-180°	33968	MANGUERA SUPERIOR-MOTOR A RAD.	22032
POLEA-	36096	MANGUERA SUPERIOR-MOTOR A RAD.	22664
2004		MANGUERA INFERIOR-MOTOR A RAD	21985
MANGUERA SUPERIOR-MOTOR A RAD.	23087	TENSOR-MOTOR	38509
MANGUERA SUPERIOR-MOTOR A RAD.	23099	BANDA-BA	9341
MANGUERA INFERIOR-MOTOR A RAD	23088	BANDA-ALT-VENT-AA	K070733
BANDA-ALT-VENT-AA	K080806	BANDA-ALT-VENT	K070705
TENSOR-ALT-VENT-AA	38586	TERMOSTATO-190°	33969
TERMOSTATO-190°	33969	TERMOSTATO-180°	33968
TERMOSTATO-180°	33968	TAPÓN DE RADIADOR-(10 LBS) SIN PALANCA	31521
POLEA-	36096	TAPÓN DE RADIADOR-(10 LBS) CON PALANCA	31537
CATERPILLAR 3126 DIESEL		MANGUERA DE AGUA-	30T 3/4"
2003		MANGUERA DE AGUA-	30T 5/8"
MANGUERA SUPERIOR-MOTOR A RAD.	22764	POLEA-	36096
MANGUERA SUPERIOR-MOTOR A RAD.	22765	POLEA DEL TENSOR-	36091
MANGUERA INFERIOR-MOTOR A RAD	22766	2000	
TENSOR-MOTOR	38557	MANGUERA SUPERIOR-MOTOR A RAD.	22032
BANDA-BA	9335	MANGUERA SUPERIOR-MOTOR A RAD.	22664
BANDA-ALT-VENT-AA	K070835	MANGUERA INFERIOR-MOTOR A RAD	21985
BANDA-ALT-VENT	K070709	TENSOR-MOTOR	38509
TERMOSTATO-190°	33969	BANDA-BA	9341
TERMOSTATO-180°	33968	BANDA-ALT-VENT-AA	K070733
TAPÓN DE RADIADOR-(10 LBS) SIN PALANCA	31521	BANDA-ALT-VENT	K070705
TAPÓN DE RADIADOR-(10 LBS) CON PALANCA	31537	TERMOSTATO-190°	33969
POLEA-	36096	TERMOSTATO-180°	33968
POLEA DEL TENSOR-	36091	TAPÓN DE RADIADOR-(10 LBS) SIN PALANCA	31521
2002		TAPÓN DE RADIADOR-(10 LBS) CON PALANCA	31537
MANGUERA SUPERIOR-MOTOR A RAD.	22032	MANGUERA DE AGUA-	30T 3/4"
MANGUERA SUPERIOR-MOTOR A RAD.	22664	MANGUERA DE AGUA-	30T 5/8"
MANGUERA INFERIOR-MOTOR A RAD	21985	POLEA-	36096
TENSOR-MOTOR	38509	POLEA DEL TENSOR-	36091
BANDA-BA	9341	1999	



MASTER SERVICIO PESADO 2014

CHEVROLET

C7500

MANGUERA SUPERIOR-MOTOR A RAD.	22032	TAPÓN DE RADIADOR-(10 LBS) CON PALANCA	31537
MANGUERA SUPERIOR-MOTOR A RAD.	22664	POLEA DEL TENSOR-	36091
MANGUERA INFERIOR-MOTOR A RAD	21985	1999	
TENSOR-MOTOR	38509	MANGUERA SUPERIOR-MOTOR A RAD.	21989
BANDA-BA	9341	MANGUERA SUPERIOR-MOTOR A RAD.	22032
BANDA-ALT-VENT-AA	K070735	MANGUERA INFERIOR-MOTOR A RAD	21985
BANDA-ALT-VENT	K070705	TENSOR-MOTOR	38509
TERMOSTATO-190°	33969	BANDA-BA	9341
TERMOSTATO-180°	33968	BANDA-ALT-VENT-AA	K070733
TAPÓN DE RADIADOR-(10 LBS) SIN PALANCA	31521	BANDA-ALT-VENT	K070705
TAPÓN DE RADIADOR-(10 LBS) CON PALANCA	31537	TERMOSTATO-190°	33969
MANGUERA DE AGUA-	30T 3/4"	TERMOSTATO-180°	33968
MANGUERA DE AGUA-	30T 5/8"	TAPÓN DE RADIADOR-(10 LBS) SIN PALANCA	31521
POLEA-	36096	TAPÓN DE RADIADOR-(10 LBS) CON PALANCA	31537
POLEA DEL TENSOR-	36091	POLEA DEL TENSOR-	36091
1998		1998	
MANGUERA SUPERIOR-MOTOR A RAD.	22032	MANGUERA SUPERIOR-MOTOR A RAD.	21989
MANGUERA SUPERIOR-MOTOR A RAD.	22664	MANGUERA SUPERIOR-MOTOR A RAD.	22032
MANGUERA INFERIOR-MOTOR A RAD	21985	MANGUERA SUPERIOR-MOTOR A RAD.	22134
TENSOR-MOTOR	38509	MANGUERA INFERIOR-MOTOR A RAD	21985
BANDA-BA	9341	TENSOR-MOTOR	38509
BANDA-ALT-VENT-AA	K070733	BANDA-BA	9341
BANDA-ALT-VENT	K070705	BANDA-ALT-VENT-AA	K070735
TERMOSTATO-190°	33969	BANDA-ALT-VENT-AA	K070825
TERMOSTATO-180°	33968	BANDA-ALT-VENT	K060672
TAPÓN DE RADIADOR-(10 LBS) SIN PALANCA	31521	BANDA-ALT-VENT	K070705
TAPÓN DE RADIADOR-(10 LBS) CON PALANCA	31537	TERMOSTATO-190°	33969
MANGUERA DE AGUA-	30T 3/4"	TERMOSTATO-180°	33968
MANGUERA DE AGUA-	30T 5/8"	TAPÓN DE RADIADOR-(10 LBS) SIN PALANCA	31521
POLEA-	36096	TAPÓN DE RADIADOR-(10 LBS) CON PALANCA	31537
POLEA DEL TENSOR-	36091	POLEA DEL TENSOR-	36091
CATERPILLAR 3116 DIESEL		1997	
2000		MANGUERA SUPERIOR-MOTOR A RAD.	21989
MANGUERA SUPERIOR-MOTOR A RAD.	21989	MANGUERA SUPERIOR-MOTOR A RAD.	22032
MANGUERA SUPERIOR-MOTOR A RAD.	22032	MANGUERA SUPERIOR-MOTOR A RAD.	22134
MANGUERA INFERIOR-MOTOR A RAD	21985	MANGUERA INFERIOR-MOTOR A RAD	21985
TENSOR-MOTOR	38509	TENSOR-MOTOR	38509
BANDA-BA	9341	BANDA-BA	9341
BANDA-ALT-VENT-AA	K070733	BANDA-ALT-VENT-AA	K070735
BANDA-ALT-VENT	K070705	BANDA-ALT-VENT-AA	K070825
TERMOSTATO-190°	33969	BANDA-ALT-VENT	K060672
TERMOSTATO-180°	33968	BANDA-ALT-VENT	K070705
TAPÓN DE RADIADOR-(10 LBS) SIN PALANCA	31521	TERMOSTATO-190°	33969



TERMOSTATO-180°	33968	BANDA-ALT-DH-VENT	K071056
TAPÓN DE RADIADOR-(10 LBS) SIN PALANCA	31521	MANGUERA INFERIOR-	22770
TAPÓN DE RADIADOR-(10 LBS) CON PALANCA	31537	MANGUERA SUPERIOR-	22769
POLEA DEL TENSOR-	36091	2007	
C8500		POLEA DEL TENSOR-VENT-COMPRESOR	38006
ISUZU 6HK1-TC DIESEL		MANGUERA SUPERIOR-MOTOR A RAD.	22854
2007		MANGUERA INFERIOR-MOTOR A RAD	22771
MANGUERA SUPERIOR-MOTOR A RAD.	22767	BANDA-COMPRESOR	K040745
MANGUERA INFERIOR-MOTOR A RAD	22768	TENSOR-COMPRESOR	38324
BANDA-BA-DH	TR22461	BANDA-ALT-DH-VENT-AA	K071247
BANDA-ALT-VENT-AA	K070786	POLEA DEL TENSOR-ALT-DH-VENT-AA	38033
2006		TENSOR-ALT-DH-VENT-AA	38256
MANGUERA SUPERIOR-MOTOR A RAD.	22767	BANDA-ALT-DH-VENT	K071056
MANGUERA INFERIOR-MOTOR A RAD	22768	2006	
TENSOR-MOTOR	38548	POLEA DEL TENSOR-VENT-COMPRESOR	38006
BANDA-BA-DH	TR22461	MANGUERA SUPERIOR-MOTOR A RAD.	22854
BANDA-ALT-VENT-AA	K070786	MANGUERA INFERIOR-MOTOR A RAD	22771
2005		BANDA-COMPRESOR	K040745
MANGUERA SUPERIOR-MOTOR A RAD.	22767	TENSOR-COMPRESOR	38324
MANGUERA INFERIOR-MOTOR A RAD	22768	BANDA-ALT-DH-VENT-AA	K071247
TENSOR-MOTOR	38548	POLEA DEL TENSOR-ALT-DH-VENT-AA	38033
BANDA-BA-DH	TR22461	TENSOR-ALT-DH-VENT-AA	38256
BANDA-ALT-VENT-AA	K070786	BANDA-ALT-DH-VENT	K071056
2004		2005	
MANGUERA SUPERIOR-MOTOR A RAD.	22767	POLEA DEL TENSOR-VENT-COMPRESOR	38006
MANGUERA INFERIOR-MOTOR A RAD	22768	MANGUERA SUPERIOR-MOTOR A RAD.	22854
TENSOR-MOTOR	38548	MANGUERA INFERIOR-MOTOR A RAD	22771
BANDA-BA-DH	TR22461	BANDA-COMPRESOR	K040745
BANDA-ALT-VENT-AA	K070786	TENSOR-COMPRESOR	38324
2003		BANDA-ALT-DH-VENT-AA	K071247
MANGUERA SUPERIOR-MOTOR A RAD.	22767	POLEA DEL TENSOR-ALT-DH-VENT-AA	38033
MANGUERA INFERIOR-MOTOR A RAD	22768	TENSOR-ALT-DH-VENT-AA	38256
TENSOR-MOTOR	38548	BANDA-ALT-DH-VENT	K071056
BANDA-BA-DH	TR22461	2004	
BANDA-ALT-VENT-AA	K070786	POLEA DEL TENSOR-VENT-COMPRESOR	38006
GM V8 8.1 L		MANGUERA SUPERIOR-MOTOR A RAD.	22854
2008		MANGUERA INFERIOR-MOTOR A RAD	22771
POLEA DEL TENSOR-VENT-COMPRESOR	38006	BANDA-COMPRESOR	K040745
BANDA-COMPRESOR	K040745	TENSOR-COMPRESOR	38324
TENSOR-COMPRESOR	38324	BANDA-ALT-DH-VENT-AA	K071247
BANDA-ALT-DH-VENT-AA	K071247	POLEA DEL TENSOR-ALT-DH-VENT-AA	38033
POLEA DEL TENSOR-ALT-DH-VENT-AA	38033	TENSOR-ALT-DH-VENT-AA	38256
TENSOR-ALT-DH-VENT-AA	38256	BANDA-ALT-DH-VENT	K071056



MASTER SERVICIO PESADO 2014

CHEVROLET

C8500

2003			
POLEA DEL TENSOR-VENT-COMPRESOR	38006	MANGUERA SUPERIOR-MOTOR A RAD.	22663
MANGUERA SUPERIOR-MOTOR A RAD.	22854	MANGUERA INFERIOR-MOTOR A RAD	22135
MANGUERA INFERIOR-MOTOR A RAD	22772	BANDA-DH-VENT-C/FRENOS HID	9640
BANDA-COMPRESOR	K040745	BANDA-C/DH-C/FRENOS DE AIRE	9395
TENSOR-COMPRESOR	38324	BANDA-C/DH	9390
BANDA-ALT-DH-VENT-AA	K071247	BANDA-ALT-VENT	K060660
POLEA DEL TENSOR-ALT-DH-VENT-AA	38033	GM V8 7.0 L	
TENSOR-ALT-DH-VENT-AA	38256	1998	
BANDA-ALT-DH-VENT	K071056	BANDA-VENT-COMPRESOR	9690
		BANDA-VENT-AA	9476
2002		MANGUERA SUPERIOR-MOTOR A RAD.	22031
BANDA-VENT-COMPRESOR	K040762	MANGUERA SUPERIOR-MOTOR A RAD.	22136
POLEA DEL TENSOR-VENT-COMPRESOR	38006	MANGUERA INFERIOR-MOTOR A RAD	21987
TENSOR-VENT-COMPRESOR	38261	MANGUERA INFERIOR-MOTOR A RAD	22030
MANGUERA SUPERIOR-MOTOR A RAD.	22678	BANDA-DH-VENT-C/FRENOS HID	9650
MANGUERA INFERIOR-MOTOR A RAD	22679	BANDA-C/DH-C/FRENOS DE AIRE	9395
BANDA-ALT-DH-VENT-AA	K071247	BANDA-ALT-VENT	K060672
POLEA DEL TENSOR-ALT-DH-VENT-AA	38033	1997	
TENSOR-ALT-DH-VENT-AA	38256	BANDA-VENT-COMPRESOR	9690
BANDA-ALT-DH-VENT	K071056	BANDA-VENT-AA	9476
		MANGUERA SUPERIOR-MOTOR A RAD.	22031
2001		MANGUERA SUPERIOR-MOTOR A RAD.	22136
BANDA-VENT-COMPRESOR	K040762	MANGUERA INFERIOR-MOTOR A RAD	21987
POLEA DEL TENSOR-VENT-COMPRESOR	38006	MANGUERA INFERIOR-MOTOR A RAD	22030
TENSOR-VENT-COMPRESOR	38261	MANGUERA INFERIOR-MOTOR A RAD	22135
MANGUERA SUPERIOR-MOTOR A RAD.	22678	BANDA-DH-VENT-C/FRENOS HID	9650
MANGUERA INFERIOR-MOTOR A RAD	22679	BANDA-C/DH-C/FRENOS DE AIRE	9395
BANDA-ALT-DH-VENT-AA	K071247	BANDA-ALT-VENT	K060672
POLEA DEL TENSOR-ALT-DH-VENT-AA	38033	GM V8 6.0 L	
TENSOR-ALT-DH-VENT-AA	38256	1998	
BANDA-ALT-DH-VENT	K071056	BANDA-VENT-COMPRESOR	9690
		BANDA-VENT-AA	9476
GM V8 7.4 L		MANGUERA SUPERIOR-MOTOR A RAD.	22031
2000		MANGUERA SUPERIOR-MOTOR A RAD.	22136
BANDA-VENT-COMPRESOR	9680	MANGUERA INFERIOR-MOTOR A RAD	21987
BANDA-VENT-AA	9476	MANGUERA INFERIOR-MOTOR A RAD	22030
MANGUERA SUPERIOR-MOTOR A RAD.	22663	BANDA-DH-VENT-C/FRENOS HID	9650
MANGUERA INFERIOR-MOTOR A RAD	22135	BANDA-C/DH-C/FRENOS DE AIRE	9395
BANDA-DH-VENT-C/FRENOS HID	9640	BANDA-ALT-VENT	K060672
BANDA-C/DH-C/FRENOS DE AIRE	9395	1997	
BANDA-C/DH	9390	BANDA-VENT-COMPRESOR	9690
BANDA-ALT-VENT	K060660	BANDA-VENT-AA	9476
		MANGUERA SUPERIOR-MOTOR A RAD.	22031
1999			
BANDA-VENT-COMPRESOR	9680		
BANDA-VENT-AA	9476		



MANGUERA SUPERIOR-MOTOR A RAD.	22136
MANGUERA INFERIOR-MOTOR A RAD	21987
MANGUERA INFERIOR-MOTOR A RAD	22030
MANGUERA INFERIOR-MOTOR A RAD	22135
BANDA-DH-VENT-C/FRENOS HID	9650
BANDA-C/DH-C/FRENOS DE AIRE	9395
BANDA-ALT-VENT	K060672

CATERPILLAR C7 DIESEL**2008**

TERMOSTATO-190°	33969
TERMOSTATO-180°	33968

2007

BANDA-ALT-VENT-AA	K080806
TENSOR-ALT-VENT-AA	38586
TERMOSTATO-190°	33969
TERMOSTATO-180°	33968
POLEA-	36096

2006

MANGUERA SUPERIOR-MOTOR A RAD.	23087
MANGUERA INFERIOR-MOTOR A RAD	23088
BANDA-ALT-VENT-AA	K080806
TENSOR-ALT-VENT-AA	38586
TERMOSTATO-190°	33969
TERMOSTATO-180°	33968
POLEA-	36096

2005

MANGUERA SUPERIOR-MOTOR A RAD.	23087
MANGUERA SUPERIOR-MOTOR A RAD.	23099
MANGUERA INFERIOR-MOTOR A RAD	23088
BANDA-ALT-VENT-AA	K080806
TENSOR-ALT-VENT-AA	38586
TERMOSTATO-190°	33969
TERMOSTATO-180°	33968
POLEA-	36096

2004

MANGUERA SUPERIOR-MOTOR A RAD.	23087
MANGUERA SUPERIOR-MOTOR A RAD.	23099
MANGUERA INFERIOR-MOTOR A RAD	23088
BANDA-ALT-VENT-AA	K080806
TENSOR-ALT-VENT-AA	38586
TERMOSTATO-190°	33969
TERMOSTATO-180°	33968
POLEA-	36096

CATERPILLAR 3126 DIESEL**2003**

MANGUERA SUPERIOR-MOTOR A RAD.	22764
MANGUERA SUPERIOR-MOTOR A RAD.	22765
MANGUERA INFERIOR-MOTOR A RAD	22766
TENSOR-MOTOR	38557
BANDA-BA	9335
BANDA-ALT-VENT-AA	K070835
BANDA-ALT-VENT	K070709

TERMOSTATO-190°	33969
TERMOSTATO-180°	33968

POLEA-	36096
POLEA DEL TENSOR-	36091

2002

MANGUERA SUPERIOR-MOTOR A RAD.	22032
MANGUERA SUPERIOR-MOTOR A RAD.	22664
MANGUERA INFERIOR-MOTOR A RAD	21985

TENSOR-MOTOR	38509
--------------	-------

BANDA-BA	9341
----------	------

BANDA-ALT-VENT-AA	K070733
-------------------	---------

BANDA-ALT-VENT	K070705
----------------	---------

TERMOSTATO-190°	33969
-----------------	-------

TERMOSTATO-180°	33968
-----------------	-------

MANGUERA DE AGUA-	30T 3/4"
-------------------	----------

MANGUERA DE AGUA-	30T 5/8"
-------------------	----------

POLEA-	36096
--------	-------

POLEA DEL TENSOR-	36091
-------------------	-------

2001

MANGUERA SUPERIOR-MOTOR A RAD.	22032
--------------------------------	-------

MANGUERA SUPERIOR-MOTOR A RAD.	22664
--------------------------------	-------

MANGUERA INFERIOR-MOTOR A RAD	21985
-------------------------------	-------

TENSOR-MOTOR	38509
--------------	-------

BANDA-BA	9341
----------	------

BANDA-ALT-VENT-AA	K070733
-------------------	---------

BANDA-ALT-VENT	K070705
----------------	---------

TERMOSTATO-190°	33969
-----------------	-------

TERMOSTATO-180°	33968
-----------------	-------

MANGUERA DE AGUA-	30T 3/4"
-------------------	----------

MANGUERA DE AGUA-	30T 5/8"
-------------------	----------

POLEA-	36096
--------	-------

POLEA DEL TENSOR-	36091
-------------------	-------

2000

MANGUERA SUPERIOR-MOTOR A RAD.	22032
--------------------------------	-------



MASTER SERVICIO PESADO 2014

CHEVROLET

C8500

MANGUERA SUPERIOR-MOTOR A RAD.	22664	MANGUERA SUPERIOR-MOTOR A RAD.	22032
MANGUERA INFERIOR-MOTOR A RAD	21985	MANGUERA INFERIOR-MOTOR A RAD	21985
TENSOR-MOTOR	38509	TENSOR-MOTOR	38509
BANDA-BA	9341	BANDA-BA	9341
BANDA-ALT-VENT-AA	K070733	BANDA-ALT-VENT-AA	K070733
BANDA-ALT-VENT	K070705	BANDA-ALT-VENT	K070705
TERMOSTATO-190°	33969	TERMOSTATO-190°	33969
TERMOSTATO-180°	33968	TERMOSTATO-180°	33968
MANGUERA DE AGUA-	30T 3/4"	POLEA DEL TENSOR-	36091
MANGUERA DE AGUA-	30T 5/8"	1999	
POLEA-	36096	MANGUERA SUPERIOR-MOTOR A RAD.	21989
POLEA DEL TENSOR-	36091	MANGUERA SUPERIOR-MOTOR A RAD.	22032
1999		MANGUERA INFERIOR-MOTOR A RAD	21985
MANGUERA SUPERIOR-MOTOR A RAD.	22032	TENSOR-MOTOR	38509
MANGUERA SUPERIOR-MOTOR A RAD.	22664	BANDA-BA	9341
MANGUERA INFERIOR-MOTOR A RAD	21985	BANDA-ALT-VENT-AA	K070733
TENSOR-MOTOR	38509	BANDA-ALT-VENT	K070705
BANDA-BA	9341	TERMOSTATO-190°	33969
BANDA-ALT-VENT-AA	K070733	TERMOSTATO-180°	33968
BANDA-ALT-VENT	K070705	POLEA DEL TENSOR-	36091
TERMOSTATO-190°	33969	1998	
TERMOSTATO-180°	33968	MANGUERA SUPERIOR-MOTOR A RAD.	21989
MANGUERA DE AGUA-	30T 3/4"	MANGUERA SUPERIOR-MOTOR A RAD.	22032
MANGUERA DE AGUA-	30T 5/8"	MANGUERA SUPERIOR-MOTOR A RAD.	22134
POLEA-	36096	MANGUERA INFERIOR-MOTOR A RAD	21985
POLEA DEL TENSOR-	36091	TENSOR-MOTOR	38509
1998		BANDA-BA	9341
MANGUERA SUPERIOR-MOTOR A RAD.	22032	BANDA-ALT-VENT-AA	K070735
MANGUERA SUPERIOR-MOTOR A RAD.	22664	BANDA-ALT-VENT-AA	K070825
MANGUERA INFERIOR-MOTOR A RAD	21985	BANDA-ALT-VENT	K060672
TENSOR-MOTOR	38509	BANDA-ALT-VENT	K070705
BANDA-BA	9341	TERMOSTATO-190°	33969
BANDA-ALT-VENT-AA	K070733	TERMOSTATO-180°	33968
BANDA-ALT-VENT	K070705	POLEA DEL TENSOR-	36091
TERMOSTATO-190°	33969	1997	
TERMOSTATO-180°	33968	MANGUERA SUPERIOR-MOTOR A RAD.	21989
MANGUERA DE AGUA-	30T 3/4"	MANGUERA SUPERIOR-MOTOR A RAD.	22032
MANGUERA DE AGUA-	30T 5/8"	MANGUERA SUPERIOR-MOTOR A RAD.	22134
POLEA-	36096	MANGUERA INFERIOR-MOTOR A RAD	21985
POLEA DEL TENSOR-	36091	TENSOR-MOTOR	38509
CATERPILLAR 3116 DIESEL		BANDA-BA	9341
2000		BANDA-ALT-VENT-AA	K070735
MANGUERA SUPERIOR-MOTOR A RAD.	21989	BANDA-ALT-VENT-AA	K070825



MASTER SERVICIO PESADO 2014

CHEVROLET

C8500

BANDA-ALT-VENT	K060672	TAPÓN DE RADIADOR-(10 LBS) SIN PALANCA	31521
BANDA-ALT-VENT	K070705	MANGUERA INFERIOR-	22679
TERMOSTATO-190°	33969	MANGUERA SUPERIOR-	22678
TERMOSTATO-180°	33968	TAPÓN DE ACEITE-	31099
POLEA DEL TENSOR-	36091	2004	
KODIAK		BANDA-VENT-COMPRESOR	K040762
GM V8, 8.1 L		BANDA-S/AA	K071056
2008		TENSOR-MOTOR	38256
BANDA-VENT-COMPRESOR	K040762	TENSOR-COMPRESOR	38261
BANDA-S/AA	K071056	BANDA-C/AA	K071247
TENSOR-MOTOR	38256	TAPÓN DE RADIADOR-(10 LBS) SIN PALANCA	31521
TENSOR-COMPRESOR	38261	MANGUERA INFERIOR-	22679
BANDA-C/AA	K071247	MANGUERA SUPERIOR-	22678
TAPÓN DE RADIADOR-(10 LBS) SIN PALANCA	31521	TAPÓN DE ACEITE-	31099
MANGUERA INFERIOR-	22679	2003	
MANGUERA SUPERIOR-	22678	BANDA-VENT-COMPRESOR	K040762
TAPÓN DE ACEITE-	31099	BANDA-S/AA	K071056
2007		TENSOR-MOTOR	38256
BANDA-VENT-COMPRESOR	K040762	TENSOR-COMPRESOR	38261
BANDA-S/AA	K071056	BANDA-C/AA	K071247
TENSOR-MOTOR	38256	TAPÓN DE RADIADOR-(10 LBS) SIN PALANCA	31521
TENSOR-COMPRESOR	38261	MANGUERA INFERIOR-	22679
BANDA-C/AA	K071247	MANGUERA SUPERIOR-	22678
TAPÓN DE RADIADOR-(10 LBS) SIN PALANCA	31521	TAPÓN DE ACEITE-	31099
MANGUERA INFERIOR-	22679	2002	
MANGUERA SUPERIOR-	22678	BANDA-VENT-COMPRESOR	K040762
TAPÓN DE ACEITE-	31099	BANDA-S/AA	K071056
2006		TENSOR-MOTOR	38256
BANDA-VENT-COMPRESOR	K040762	TENSOR-COMPRESOR	38261
BANDA-S/AA	K071056	BANDA-C/AA	K071247
TENSOR-MOTOR	38256	TAPÓN DE RADIADOR-(10 LBS) SIN PALANCA	31521
TENSOR-COMPRESOR	38261	MANGUERA INFERIOR-	22679
BANDA-C/AA	K071247	MANGUERA SUPERIOR-	22678
TAPÓN DE RADIADOR-(10 LBS) SIN PALANCA	31521	TAPÓN DE ACEITE-	31099
MANGUERA INFERIOR-	22679	2001	
MANGUERA SUPERIOR-	22678	BANDA-VENT-COMPRESOR	K040762
TAPÓN DE ACEITE-	31099	BANDA-S/AA	K071056
2005		TENSOR-MOTOR	38256
BANDA-VENT-COMPRESOR	K040762	TENSOR-COMPRESOR	38261
BANDA-S/AA	K071056	BANDA-C/AA	K071247
TENSOR-MOTOR	38256	TAPÓN DE RADIADOR-(10 LBS) SIN PALANCA	31521
TENSOR-COMPRESOR	38261	MANGUERA INFERIOR-	22679
BANDA-C/AA	K071247	MANGUERA SUPERIOR-	22678



MASTER SERVICIO PESADO 2014

CHEVROLET

KODIAK

TAPÓN DE ACEITE-	31099	MANGUERA INFERIOR-	22135
GM V8, 7.4 L			
2000			
BANDA-VENT-AA-COMPRESOR	8680 GS	MANGUERA SUPERIOR-	22663
BANDA-VENT-AA	8476 GS	TAPÓN DE ACEITE-	31099
BANDA-DH-VENT	8643 GS	1996	
BANDA-C/DH	8395 GS	BANDA-VENT-AA-COMPRESOR	8680 GS
BANDA-C/DH	8400 GS	BANDA-VENT-AA	8476 GS
BANDA-ALT-VENT	K060660	BANDA-DH-VENT	8643 GS
TAPÓN DE RADIADOR-(10 LBS) SIN PALANCA	31521	BANDA-C/DH	8395 GS
MANGUERA INFERIOR-	22135	BANDA-C/DH	8400 GS
MANGUERA SUPERIOR-	22663	BANDA-ALT-VENT	K060660
TAPÓN DE ACEITE-	31099	TAPÓN DE RADIADOR-(10 LBS) SIN PALANCA	31521
1999			
BANDA-VENT-AA-COMPRESOR	8680 GS	MANGUERA INFERIOR-	22135
BANDA-VENT-AA	8476 GS	MANGUERA SUPERIOR-	22663
BANDA-DH-VENT	8643 GS	TAPÓN DE ACEITE-	31099
BANDA-C/DH	8395 GS	1995	
BANDA-C/DH	8400 GS	BANDA-VENT-AA-COMPRESOR	8680 GS
BANDA-ALT-VENT	K060660	BANDA-VENT-AA	8476 GS
TAPÓN DE RADIADOR-(10 LBS) SIN PALANCA	31521	BANDA-DH-VENT	8643 GS
MANGUERA INFERIOR-	22135	BANDA-C/DH	8395 GS
MANGUERA SUPERIOR-	22663	BANDA-C/DH	8400 GS
TAPÓN DE ACEITE-	31099	BANDA-ALT-VENT	K060660
1998			
BANDA-VENT-AA-COMPRESOR	8680 GS	TAPÓN DE RADIADOR-(10 LBS) SIN PALANCA	31521
BANDA-VENT-AA	8476 GS	MANGUERA INFERIOR-	22135
BANDA-DH-VENT	8643 GS	MANGUERA SUPERIOR-	22663
BANDA-C/DH	8395 GS	TAPÓN DE ACEITE-	31099
BANDA-C/DH	8400 GS	CATERPILLAR 3126 DIESEL	
BANDA-ALT-VENT	K060660	2008	
TAPÓN DE RADIADOR-(10 LBS) SIN PALANCA	31521	POLEA-MOTOR	36096
MANGUERA INFERIOR-	22135	TENSOR-MOTOR	38509
MANGUERA SUPERIOR-	22663	BANDA-BA	8345 GS
TAPÓN DE ACEITE-	31099	BANDA-ALT-VENT	K070705
1997			
BANDA-VENT-AA-COMPRESOR	8680 GS	BANDA-ALT-VENT	K070733
BANDA-VENT-AA	8476 GS	TERMOSTATO-190°	33969
BANDA-DH-VENT	8643 GS	TERMOSTATO-180°	33968
BANDA-C/DH	8395 GS	TAPÓN DE RADIADOR-(10 LBS) SIN PALANCA	31521
BANDA-C/DH	8400 GS	MANGUERA INFERIOR-	21985
BANDA-ALT-VENT	K060660	MANGUERA SUPERIOR-	22664
TAPÓN DE RADIADOR-(10 LBS) SIN PALANCA	31521	POLEA DEL TENSOR-	36091
2007			
BANDA-VENT-AA-COMPRESOR	8680 GS	POLEA-MOTOR	36096
BANDA-VENT-AA	8476 GS	TENSOR-MOTOR	38509
BANDA-DH-VENT	8643 GS	BANDA-BA	8345 GS
BANDA-C/DH	8395 GS	BANDA-ALT-VENT	K070705
BANDA-C/DH	8400 GS		
BANDA-ALT-VENT	K060660		
TAPÓN DE RADIADOR-(10 LBS) SIN PALANCA	31521		



MASTER SERVICIO PESADO 2014

CHEVROLET

KODIAK

BANDA-ALT-VENT	K070733	2003	
TERMOSTATO-190°	33969	POLEA-MOTOR	36096
TERMOSTATO-180°	33968	TENSOR-MOTOR	38509
TAPÓN DE RADIADOR-(10 LBS) SIN PALANCA	31521	BANDA-BA	8345 GS
MANGUERA INFERIOR-	21985	BANDA-ALT-VENT	K070705
MANGUERA SUPERIOR-	22664	BANDA-ALT-VENT	K070733
POLEA DEL TENSOR-	36091	TERMOSTATO-190°	33969
2006		TERMOSTATO-180°	33968
POLEA-MOTOR	36096	TAPÓN DE RADIADOR-(10 LBS) SIN PALANCA	31521
TENSOR-MOTOR	38509	MANGUERA INFERIOR-	21985
BANDA-BA	8345 GS	MANGUERA SUPERIOR-	22664
BANDA-ALT-VENT	K070705	POLEA DEL TENSOR-	36091
BANDA-ALT-VENT	K070733	2002	
TERMOSTATO-190°	33969	POLEA-MOTOR	36096
TERMOSTATO-180°	33968	TENSOR-MOTOR	38509
TAPÓN DE RADIADOR-(10 LBS) SIN PALANCA	31521	BANDA-BA	8345 GS
MANGUERA INFERIOR-	21985	BANDA-ALT-VENT	K070705
MANGUERA SUPERIOR-	22664	BANDA-ALT-VENT	K070733
POLEA DEL TENSOR-	36091	TERMOSTATO-190°	33969
2005		TERMOSTATO-180°	33968
POLEA-MOTOR	36096	TAPÓN DE RADIADOR-(10 LBS) SIN PALANCA	31521
TENSOR-MOTOR	38509	MANGUERA INFERIOR-	21985
BANDA-BA	8345 GS	MANGUERA SUPERIOR-	22664
BANDA-ALT-VENT	K070705	POLEA DEL TENSOR-	36091
BANDA-ALT-VENT	K070733	2001	
TERMOSTATO-190°	33969	POLEA-MOTOR	36096
TERMOSTATO-180°	33968	TENSOR-MOTOR	38509
TAPÓN DE RADIADOR-(10 LBS) SIN PALANCA	31521	BANDA-BA	8345 GS
MANGUERA INFERIOR-	21985	BANDA-ALT-VENT	K070705
MANGUERA SUPERIOR-	22664	BANDA-ALT-VENT	K070733
POLEA DEL TENSOR-	36091	TERMOSTATO-190°	33969
2004		TERMOSTATO-180°	33968
POLEA-MOTOR	36096	TAPÓN DE RADIADOR-(10 LBS) SIN PALANCA	31521
TENSOR-MOTOR	38509	MANGUERA INFERIOR-	21985
BANDA-BA	8345 GS	MANGUERA SUPERIOR-	22664
BANDA-ALT-VENT	K070705	POLEA DEL TENSOR-	36091
BANDA-ALT-VENT	K070733	2000	
TERMOSTATO-190°	33969	POLEA-MOTOR	36096
TERMOSTATO-180°	33968	TENSOR-MOTOR	38509
TAPÓN DE RADIADOR-(10 LBS) SIN PALANCA	31521	BANDA-BA	8345 GS
MANGUERA INFERIOR-	21985	BANDA-ALT-VENT	K070705
MANGUERA SUPERIOR-	22664	BANDA-ALT-VENT	K070733
POLEA DEL TENSOR-	36091	TERMOSTATO-190°	33969



MASTER SERVICIO PESADO 2014

CHEVROLET

KODIAK

TERMOSTATO-180°	33968	POLEA-MOTOR	36096
TAPÓN DE RADIADOR-(10 LBS) SIN PALANCA	31521	TENSOR-MOTOR	38509
MANGUERA INFERIOR-	21985	BANDA-BA	8345 GS
MANGUERA SUPERIOR-	22664	BANDA-ALT-VENT	K070705
POLEA DEL TENSOR-	36091	BANDA-ALT-VENT	K070733
CATERPILLAR 3116 DIESEL		TERMOSTATO-190°	33969
2000		TERMOSTATO-180°	33968
POLEA-MOTOR	36096	TAPÓN DE RADIADOR-(10 LBS) SIN PALANCA	31521
TENSOR-MOTOR	38509	MANGUERA INFERIOR-	21985
BANDA-BA	8345 GS	MANGUERA SUPERIOR-	22032
BANDA-ALT-VENT	K070705	POLEA DEL TENSOR-	36091
BANDA-ALT-VENT	K070733	1996	
TERMOSTATO-190°	33969	BANDA-VENT-AA	K070735
TERMOSTATO-180°	33968	BANDA-VENT	K070673
TAPÓN DE RADIADOR-(10 LBS) SIN PALANCA	31521	BANDA-BA	8350 GS
MANGUERA INFERIOR-	21985	BANDA-ALT	K070705
MANGUERA SUPERIOR-	22664	T6500	
POLEA DEL TENSOR-	36091	ISUZU 6HK1-TC DIESEL	
1999		2008	
POLEA-MOTOR	36096	MANGUERA SUPERIOR-MOTOR A RAD.	22855
TENSOR-MOTOR	38509	BANDA-ALT-VENT-AA	K080726
BANDA-BA	8345 GS	TENSOR-ALT-VENT-AA	38579
BANDA-ALT-VENT	K070705	2007	
BANDA-ALT-VENT	K070733	MANGUERA SUPERIOR-MOTOR A RAD.	22855
TERMOSTATO-190°	33969	MANGUERA INFERIOR-MOTOR A RAD	22856
TERMOSTATO-180°	33968	BANDA-ALT-VENT-AA	K080726
TAPÓN DE RADIADOR-(10 LBS) SIN PALANCA	31521	TENSOR-ALT-VENT-AA	38579
MANGUERA INFERIOR-	21985	BANDA-ALT-VENT	K080550
MANGUERA SUPERIOR-	22032	2006	
POLEA DEL TENSOR-	36091	MANGUERA SUPERIOR-MOTOR A RAD.	22855
1998		MANGUERA INFERIOR-MOTOR A RAD	22856
POLEA-MOTOR	36096	BANDA-ALT-VENT-AA	K080726
TENSOR-MOTOR	38509	TENSOR-ALT-VENT-AA	38579
BANDA-BA	8345 GS	BANDA-ALT-VENT	K080550
BANDA-ALT-VENT	K070705	2005	
BANDA-ALT-VENT	K070733	MANGUERA SUPERIOR-MOTOR A RAD.	22855
TERMOSTATO-190°	33969	MANGUERA INFERIOR-MOTOR A RAD	22856
TERMOSTATO-180°	33968	BANDA-ALT-VENT-AA	K080726
TAPÓN DE RADIADOR-(10 LBS) SIN PALANCA	31521	TENSOR-ALT-VENT-AA	38579
MANGUERA INFERIOR-	21985	BANDA-ALT-VENT	K080550
MANGUERA SUPERIOR-	22032	T7500	
POLEA DEL TENSOR-	36091	ISUZU 6HK1-TC DIESEL	
1997		2008	



MASTER SERVICIO PESADO 2014

CHEVROLET

T7500

MANGUERA SUPERIOR-MOTOR A RAD.	22855
BANDA-ALT-VENT-AA	K080726
TENSOR-ALT-VENT-AA	38579

2007

MANGUERA SUPERIOR-MOTOR A RAD.	22855
MANGUERA INFERIOR-MOTOR A RAD	22856
BANDA-ALT-VENT-AA	K080726
TENSOR-ALT-VENT-AA	38579
BANDA-ALT-VENT	K080550

2006

MANGUERA SUPERIOR-MOTOR A RAD.	22855
MANGUERA INFERIOR-MOTOR A RAD	22856
BANDA-ALT-VENT-AA	K080726
TENSOR-ALT-VENT-AA	38579
BANDA-ALT-VENT	K080550

2005

MANGUERA SUPERIOR-MOTOR A RAD.	22855
MANGUERA INFERIOR-MOTOR A RAD	22856
BANDA-ALT-VENT-AA	K080726
TENSOR-ALT-VENT-AA	38579
BANDA-ALT-VENT	K080550

T8500

ISUZU 6HK1-TC DIESEL

2008

MANGUERA SUPERIOR-MOTOR A RAD.	22855
BANDA-ALT-VENT-AA	K080726
TENSOR-ALT-VENT-AA	38579

2007

MANGUERA SUPERIOR-MOTOR A RAD.	22855
MANGUERA INFERIOR-MOTOR A RAD	22856
BANDA-ALT-VENT-AA	K080726
TENSOR-ALT-VENT-AA	38579
BANDA-ALT-VENT	K080550

2006

MANGUERA SUPERIOR-MOTOR A RAD.	22855
MANGUERA INFERIOR-MOTOR A RAD	22856
BANDA-ALT-VENT-AA	K080726
TENSOR-ALT-VENT-AA	38579
BANDA-ALT-VENT	K080550

2005

MANGUERA SUPERIOR-MOTOR A RAD.	22855
MANGUERA INFERIOR-MOTOR A RAD	22856
BANDA-ALT-VENT-AA	K080726

TENSOR-ALT-VENT-AA	38579
BANDA-ALT-VENT	K080550

DINA



102 F

CUMMINS ISB

2009

TENSOR-MOTOR	38516
BANDA-ALT-VENT	BX52
BANDA-ALT	BX53
TERMOSTATO-190°	33579
BANDA-	K080730

2008

TENSOR-MOTOR	38516
BANDA-ALT-VENT	BX52
BANDA-ALT	BX53
TERMOSTATO-190°	33579
BANDA-	K080730

104-R

CUMMINS ISB

2009

TENSOR-MOTOR	38516
BANDA-ALT-VENT	BX52
BANDA-ALT	BX53
TERMOSTATO-190°	33579
BANDA-	K080730

2008

TENSOR-MOTOR	38516
BANDA-ALT-VENT	BX52
BANDA-ALT	BX53
TERMOSTATO-190°	33579
BANDA-	K080730

104-SF

CUMMINS ISB

2009

TENSOR-MOTOR	38516
BANDA-ALT-VENT	BX52
BANDA-ALT	BX53
TERMOSTATO-190°	33579
BANDA-	K080730

2008



MASTER SERVICIO PESADO 2014

DINA

104-SF

TENSOR-MOTOR	38516	BANDA-AA	BX94
BANDA-ALT-VENT	BX52	MANGUERA INFERIOR-	CHARTER 3"
BANDA-ALT	BX53	MANGUERA SUPERIOR-	CHARTER 2 1/4"
TERMOSTATO-190°	33579	1990	
BANDA-	K080730	BANDA-VENT	BX90

94 F

CUMMINS ISB

2008		BANDA-AA	BX94
TENSOR-MOTOR	38516	MANGUERA INFERIOR-	CHARTER 3"
BANDA-BANDA	BX52	MANGUERA SUPERIOR-	CHARTER 2 1/4"

BANDA-BANDA	BX53		
TERMOSTATO-190°	33579		
BANDA-	K080730		

AVANTE

DETROIT DIESEL V8

1992		1998	
BANDA-VENT	BX88	BANDA-VENT	AX70
BANDA-DH	PQ17520	BANDA-ALT	AX69
BANDA-AA	BX93	MANGUERA INFERIOR-	CH-123212
MANGUERA INFERIOR-	CHARTER 3"	1997	
MANGUERA SUPERIOR-	CHARTER 2 1/4"	BANDA-VENT	AX70

1991		BANDA-ALT	AX69
BANDA-VENT	BX88	MANGUERA INFERIOR-	CH-123212
BANDA-DH	PQ17520	1996	
BANDA-AA	BX93	BANDA-VENT	AX70
MANGUERA INFERIOR-	CHARTER 3"	BANDA-ALT	AX69
MANGUERA SUPERIOR-	CHARTER 2 1/4"	MANGUERA INFERIOR-	CH-123212

1990		1995	
BANDA-VENT	BX88	BANDA-VENT	AX70
BANDA-DH	PQ17520	BANDA-ALT	AX69
BANDA-AA	BX93	MANGUERA INFERIOR-	CH-123212
MANGUERA INFERIOR-	CHARTER 3"	1994	
MANGUERA SUPERIOR-	CHARTER 2 1/4"	BANDA-VENT	AX70

DETROIT DIESEL V6

1992		BANDA-ALT	AX69
BANDA-VENT	BX90	MANGUERA INFERIOR-	CH-123212
BANDA-DH	PQ17480	1993	
BANDA-AA	BX94	BANDA-VENT	AX70
MANGUERA INFERIOR-	CHARTER 3"	BANDA-ALT	AX69
MANGUERA SUPERIOR-	CHARTER 2 1/4"	MANGUERA INFERIOR-	CH-123212

1991		1992	
BANDA-VENT	BX90	BANDA-VENT	AX70
BANDA-DH	PQ17480	BANDA-ALT	AX69
		MANGUERA INFERIOR-	CH-123212

DETROIT DIESEL SERIE 60, 12.7 L

1998		1997	
BANDA-ALT	BX90	BANDA-ALT	K080730



MASTER SERVICIO PESADO 2014

DINA

CITUS

BANDA-ALT	K080730
1996	
BANDA-ALT	K080730
1995	
BANDA-ALT	K080730
1994	
BANDA-ALT	K080730

D-500 HTQ

CATERPILLAR 3126 DIESEL

2000	
BANDA-C/DH	K060760
BANDA-BA	8350 GS
1999	
BANDA-C/DH	K060760
BANDA-BA	8350 GS
1998	
BANDA-C/DH	K060760
BANDA-BA	8350 GS
1997	
BANDA-C/DH	K060760
BANDA-BA	8350 GS
1996	
BANDA-C/DH	K060760
BANDA-BA	8350 GS

D-600 HTQ

CATERPILLAR 3126 DIESEL

2000	
BANDA-C/DH	K060760
BANDA-BA	8350 GS
1999	
BANDA-C/DH	K060760
BANDA-BA	8350 GS
1998	
BANDA-C/DH	K060760
BANDA-BA	8350 GS
1997	
BANDA-C/DH	K060760
BANDA-BA	8350 GS
1996	
BANDA-C/DH	K060760
BANDA-BA	8350 GS

D-7400 HTQ

CATERPILLAR 3126 E DIESEL

2000	
------	--

BANDA-DH	8345 GS
BANDA-ALT	K080825
1999	
BANDA-DH	8345 GS
BANDA-ALT	K080825
1998	
BANDA-DH	8345 GS
BANDA-ALT	K080825
1997	
BANDA-DH	8345 GS
BANDA-ALT	K080825
1996	
BANDA-DH	8345 GS
BANDA-ALT	K080825

CATERPILLAR 3126 DIESEL

2000	
BANDA-VENT	K080839
BANDA-DH	8345 GS
1999	
BANDA-VENT	K080839
BANDA-DH	8345 GS
1998	
BANDA-VENT	K080839
BANDA-DH	8345 GS
1997	
BANDA-VENT	K080839
BANDA-DH	8345 GS
1996	
BANDA-VENT	K080839
BANDA-DH	8345 GS

D-9400

CUMMINS N14 DIESEL

1994	
BANDA-VENT	PQ28483
BANDA-BA	K060436
BANDA-ALT	PQ17450
1993	
BANDA-VENT	PQ28483
BANDA-BA	K060436
BANDA-ALT	PQ17450
1992	
BANDA-VENT	PQ28483
BANDA-BA	K060436
BANDA-ALT	PQ17450



1991	
BANDA-VENT	PQ28483
BANDA-BA	K060436
BANDA-ALT	PQ17450

1990	
BANDA-VENT	PQ28483
BANDA-BA	K060436
BANDA-ALT	PQ17450

D-9400 EAGLE

DETROIT DIESEL SERIE 60, 12.7 L

1994	
BANDA-VENT	PQ28580
BANDA-BA	K060436
BANDA-AA	8405 GS

1993	
BANDA-VENT	PQ28580
BANDA-BA	K060436
BANDA-AA	8405 GS

1992	
BANDA-VENT	K100540
BANDA-ALT	8324 GS

1991	
BANDA-VENT	K100540
BANDA-ALT	8324 GS

1990	
BANDA-VENT	K100540
BANDA-ALT	8324 GS

CUMMINS NTC 400	
1994	
BANDA-BA	K060436
BANDA-ALT	PQ17460
BANDA-AA	PQ17440

1993	
BANDA-BA	K060436
BANDA-ALT	PQ17460
BANDA-AA	PQ17440

1992	
BANDA-BA	K060436
BANDA-ALT	PQ17460
BANDA-AA	PQ17440

1991	
BANDA-BA	K060436
BANDA-ALT	PQ17460
BANDA-AA	PQ17440

1990	
BANDA-BA	K060436
BANDA-ALT	PQ17460
BANDA-AA	PQ17440

DORADO

DETROIT DIESEL SERIE 60, 12.7 L

1996	
BANDA-VENT	BX88
BANDA-ALT	K080700
BANDA-AA	BX99

1995	
BANDA-VENT	BX88
BANDA-ALT	K080700
BANDA-AA	BX99

1994	
BANDA-VENT	BX88
BANDA-ALT	K080700
BANDA-AA	BX99

1993	
BANDA-VENT	BX88
BANDA-ALT	K080700
BANDA-AA	BX99

1992	
BANDA-VENT	BX88
BANDA-ALT	K080700
BANDA-AA	BX99

F-11

DETROIT DIESEL SERIE 50

1999	
BANDA-VENT	5VX600
BANDA-ALT	8650 GS
BANDA-AA	BX90

1998	
BANDA-VENT	5VX600
BANDA-ALT	8650 GS
BANDA-AA	BX90

1997	
BANDA-VENT	5VX600
BANDA-ALT	8650 GS
BANDA-AA	BX90

LINNER

CUMMINS ISB 6.7 L

2014	
-------------	--



MASTER SERVICIO PESADO 2014

DINA

LINNER

BANDA-VENT	BX53	1995	
BANDA-TENSOR VENT-VENT	BX53	BANDA-VENT	BX92
BANDA-COMPRESOR AA	AX39	BANDA-ALT	K080774
BANDA-CIGÜEÑAL A TENSOR COMPRESOR AA	BX37	BANDA-AA	BX91
2013		1994	
BANDA-VENT	BX53	BANDA-VENT	BX92
BANDA-TENSOR VENT-VENT	BX53	BANDA-ALT	K080774
BANDA-COMPRESOR AA	AX39	BANDA-AA	BX91
BANDA-CIGÜEÑAL A TENSOR COMPRESOR AA	BX37	1993	
2012		BANDA-VENT	BX92
BANDA-VENT	BX53	BANDA-ALT	K080774
BANDA-TENSOR VENT-VENT	BX53	BANDA-AA	BX91
BANDA-COMPRESOR AA	AX39	1992	
BANDA-CIGÜEÑAL A TENSOR COMPRESOR AA	BX37	BANDA-VENT	BX92
2011		BANDA-ALT	K080774
BANDA-VENT	BX53	BANDA-AA	BX91
BANDA-TENSOR VENT-VENT	BX53	MARCOPOLO PARADISO	
BANDA-COMPRESOR AA	AX39	DETROIT DIESEL SERIE 60, 12.7 L	
BANDA-CIGÜEÑAL A TENSOR COMPRESOR AA	BX37	1997	
2010		BANDA-VENT	BX90
BANDA-VENT	BX53	BANDA-ALT	K120720
BANDA-TENSOR VENT-VENT	BX53	BANDA-AA	BX97
BANDA-COMPRESOR AA	AX39	1996	
BANDA-CIGÜEÑAL A TENSOR COMPRESOR AA	BX37	BANDA-VENT	BX90
2009		BANDA-ALT	K120720
BANDA-VENT	BX53	BANDA-AA	BX97
BANDA-TENSOR VENT-VENT	BX53	1995	
BANDA-COMPRESOR AA	AX39	BANDA-VENT	BX90
BANDA-CIGÜEÑAL A TENSOR COMPRESOR AA	BX37	BANDA-ALT	K120720
MARCOPOLO GV850		BANDA-AA	BX97
CATERPILLAR C10 DIESEL		1994	
1998		BANDA-VENT	BX90
BANDA-VENT	BX92	BANDA-ALT	K120720
BANDA-ALT	K080774	BANDA-AA	BX97
BANDA-AA	BX91	1993	
1997		BANDA-VENT	BX90
BANDA-VENT	BX92	BANDA-ALT	K120720
BANDA-ALT	K080774	BANDA-AA	BX97
BANDA-AA	BX91	1992	
1996		BANDA-VENT	BX90
BANDA-VENT	BX92	BANDA-ALT	K120720
BANDA-ALT	K080774	BANDA-AA	BX97
BANDA-AA	BX91	1992	
1996		BANDA-VENT	BX90
BANDA-VENT	BX92	BANDA-ALT	K120720
BANDA-ALT	K080774	BANDA-AA	BX97
BANDA-AA	BX91	MARCOPOLO VIAGGIO GV1000	



DETROIT DIESEL SERIE 60, 12.7 L

1998	
BANDA-VENT	BX90
BANDA-ALT	K120720
BANDA-AA	BX97
1997	
BANDA-VENT	BX90
BANDA-ALT	K120720
BANDA-AA	BX97
1996	
BANDA-VENT	BX90
BANDA-ALT	K120720
BANDA-AA	BX97
1995	
BANDA-VENT	BX90
BANDA-ALT	K120720
BANDA-AA	BX97
1994	
BANDA-VENT	BX90
BANDA-ALT	K120720
BANDA-AA	BX97

OUTSIDER

CUMMINS ISB 6.7 L

2014	
BANDA-VENT	BX55
BANDA-TENSOR VENT-VENT	BX54
BANDA-TENSOR COMPRESOR-COMPRESOR	BX62
BANDA-COMPRESOR AA	AX41
BANDA-CIGÜEÑAL A TENSOR COMPRESOR AA	BX37
2013	
BANDA-VENT	BX55
BANDA-TENSOR VENT-VENT	BX54
BANDA-TENSOR COMPRESOR-COMPRESOR	BX62
BANDA-COMPRESOR AA	AX41
BANDA-CIGÜEÑAL A TENSOR COMPRESOR AA	BX37
2012	
BANDA-VENT	BX55
BANDA-TENSOR VENT-VENT	BX54
BANDA-TENSOR COMPRESOR-COMPRESOR	BX62
BANDA-COMPRESOR AA	AX41
BANDA-CIGÜEÑAL A TENSOR COMPRESOR AA	BX37
2011	
BANDA-VENT	BX55

BANDA-TENSOR VENT-VENT	BX54
BANDA-TENSOR COMPRESOR-COMPRESOR	BX62
BANDA-COMPRESOR AA	AX41
BANDA-CIGÜEÑAL A TENSOR COMPRESOR AA	BX37
2010	
BANDA-VENT	BX55
BANDA-TENSOR VENT-VENT	BX54
BANDA-TENSOR COMPRESOR-COMPRESOR	BX62
BANDA-COMPRESOR AA	AX41
BANDA-CIGÜEÑAL A TENSOR COMPRESOR AA	BX37
2009	
BANDA-VENT	BX55
BANDA-TENSOR VENT-VENT	BX54
BANDA-TENSOR COMPRESOR-COMPRESOR	BX62
BANDA-COMPRESOR AA	AX41
BANDA-CIGÜEÑAL A TENSOR COMPRESOR AA	BX37

S-400

PERKINS 5.8 L DIESEL

1997	
BANDA-DH	8600 GS
BANDA-ALT	PQ17530
TERMOSTATO-195°	33009
TERMOSTATO-180°	33008
MANGUERA INFERIOR-	CH-120692
MANGUERA SUPERIOR-	CH-122011
1996	
BANDA-DH	8600 GS
BANDA-ALT	PQ17530
TERMOSTATO-195°	33009
TERMOSTATO-180°	33008
MANGUERA INFERIOR-	CH-120692
MANGUERA SUPERIOR-	CH-122011
1995	
BANDA-DH	8600 GS
BANDA-ALT	PQ17530
TERMOSTATO-195°	33009
TERMOSTATO-180°	33008
MANGUERA INFERIOR-	CH-120692
MANGUERA SUPERIOR-	CH-122011
1994	
BANDA-DH	8600 GS
BANDA-ALT	PQ17530
TERMOSTATO-195°	33009



MASTER SERVICIO PESADO 2014

DINA

S-400

TERMOSTATO-180°	33008	TERMOSTATO-170°	33167
MANGUERA INFERIOR-	CH-120692	MANGUERA INFERIOR-	CH-121042
MANGUERA SUPERIOR-	CH-122011	MANGUERA SUPERIOR-	21765
1993		1995	
BANDA-DH	8600 GS	BANDA-COMPRESOR	TR22770
BANDA-ALT	PQ17530	BANDA-ALT	AX69
TERMOSTATO-195°	33009	TERMOSTATO-180°	33168
TERMOSTATO-180°	33008	TERMOSTATO-170°	33167
MANGUERA INFERIOR-	CH-120692	MANGUERA INFERIOR-	CH-121042
MANGUERA SUPERIOR-	CH-122011	MANGUERA SUPERIOR-	21765
1992		1994	
BANDA-DH	8600 GS	BANDA-COMPRESOR	TR22770
BANDA-ALT	PQ17530	BANDA-ALT	AX69
TERMOSTATO-195°	33009	TERMOSTATO-180°	33168
TERMOSTATO-180°	33008	TERMOSTATO-170°	33167
MANGUERA INFERIOR-	CH-120692	MANGUERA INFERIOR-	CH-121042
MANGUERA SUPERIOR-	CH-122011	MANGUERA SUPERIOR-	21765
1991		1993	
BANDA-DH	8600 GS	BANDA-COMPRESOR	TR22770
BANDA-ALT	PQ17530	BANDA-ALT	AX69
TERMOSTATO-195°	33009	TERMOSTATO-180°	33168
TERMOSTATO-180°	33008	TERMOSTATO-170°	33167
MANGUERA INFERIOR-	CH-120692	MANGUERA INFERIOR-	CH-121042
MANGUERA SUPERIOR-	CH-122011	MANGUERA SUPERIOR-	21765
1990		1992	
BANDA-DH	8600 GS	BANDA-COMPRESOR	TR22770
BANDA-ALT	PQ17530	BANDA-ALT	AX69
TERMOSTATO-195°	33009	TERMOSTATO-180°	33168
TERMOSTATO-180°	33008	TERMOSTATO-170°	33167
MANGUERA INFERIOR-	CH-120692	MANGUERA INFERIOR-	CH-121042
MANGUERA SUPERIOR-	CH-122011	MANGUERA SUPERIOR-	21765
INTERNATIONAL/NAVISTAR DT360 DIESEL		1991	
1997		BANDA-COMPRESOR	TR22770
BANDA-COMPRESOR	TR22770	BANDA-ALT	AX69
BANDA-ALT	AX69	TERMOSTATO-180°	33168
TERMOSTATO-180°	33168	TERMOSTATO-170°	33167
TERMOSTATO-170°	33167	MANGUERA INFERIOR-	CH-121042
MANGUERA INFERIOR-	CH-121042	MANGUERA SUPERIOR-	21765
MANGUERA SUPERIOR-	21765	1990	
1996		BANDA-COMPRESOR	TR22770
BANDA-COMPRESOR	TR22770	BANDA-ALT	AX69
BANDA-ALT	AX69	TERMOSTATO-180°	33168
TERMOSTATO-180°	33168	TERMOSTATO-170°	33167



MANGUERA INFERIOR-	CH-121042	BANDA-COMPRESOR	TR22770
MANGUERA SUPERIOR-	21765	BANDA-ALT	9700
S-500		MANGUERA SUPERIOR-	21765
INTERNATIONAL/NAVISTAR DT466 DIESEL		1991	
1997		MANGUERA INFERIOR-TUBO A RAD	21115
MANGUERA INFERIOR-TUBO A RAD	21115	MANGUERA INFERIOR-MOTOR A TUBO	21842
MANGUERA INFERIOR-MOTOR A TUBO	21842	BANDA-DH	BX77
BANDA-DH	BX77	BANDA-COMPRESOR	TR22770
BANDA-COMPRESOR	TR22770	BANDA-ALT	9700
BANDA-ALT	9700	MANGUERA SUPERIOR-	21765
MANGUERA SUPERIOR-	21765	1990	
1996		MANGUERA INFERIOR-TUBO A RAD	21115
MANGUERA INFERIOR-TUBO A RAD	21115	MANGUERA INFERIOR-MOTOR A TUBO	21842
MANGUERA INFERIOR-MOTOR A TUBO	21842	BANDA-DH	BX77
BANDA-DH	BX77	BANDA-COMPRESOR	TR22770
BANDA-COMPRESOR	TR22770	BANDA-ALT	9700
BANDA-ALT	9700	MANGUERA SUPERIOR-	21765
MANGUERA SUPERIOR-	21765	INTERNATIONAL/NAVISTAR DT360 DIESEL	
1995		1997	
MANGUERA INFERIOR-TUBO A RAD	21115	BANDA-COMPRESOR	TR22770
MANGUERA INFERIOR-MOTOR A TUBO	21842	BANDA-ALT	AX69
BANDA-DH	BX77	TERMOSTATO-180°	33168
BANDA-COMPRESOR	TR22770	TERMOSTATO-170°	33167
BANDA-ALT	9700	MANGUERA INFERIOR-	CH-121042
MANGUERA SUPERIOR-	21765	MANGUERA SUPERIOR-	21765
1994		1996	
MANGUERA INFERIOR-TUBO A RAD	21115	BANDA-COMPRESOR	TR22770
MANGUERA INFERIOR-MOTOR A TUBO	21842	BANDA-ALT	AX69
BANDA-DH	BX77	TERMOSTATO-180°	33168
BANDA-COMPRESOR	TR22770	TERMOSTATO-170°	33167
BANDA-ALT	9700	MANGUERA INFERIOR-	CH-121042
MANGUERA SUPERIOR-	21765	MANGUERA SUPERIOR-	21765
1993		1995	
MANGUERA INFERIOR-TUBO A RAD	21115	BANDA-COMPRESOR	TR22770
MANGUERA INFERIOR-MOTOR A TUBO	21842	BANDA-ALT	AX69
BANDA-DH	BX77	TERMOSTATO-180°	33168
BANDA-COMPRESOR	TR22770	TERMOSTATO-170°	33167
BANDA-ALT	9700	MANGUERA INFERIOR-	CH-121042
MANGUERA SUPERIOR-	21765	MANGUERA SUPERIOR-	21765
1992		1994	
MANGUERA INFERIOR-TUBO A RAD	21115	BANDA-COMPRESOR	TR22770
MANGUERA INFERIOR-MOTOR A TUBO	21842	BANDA-ALT	AX69
BANDA-DH	BX77	TERMOSTATO-180°	33168



MASTER SERVICIO PESADO 2014

DINA

S-500

TERMOSTATO-170°	33167	PERKINS FASE IV C6-354.4 (5.8 L)	
MANGUERA INFERIOR-	CH-121042	1990	
MANGUERA SUPERIOR-	21765	BANDA-DH	8600 GS
1993		BANDA-ALT	PQ17530
BANDA-COMPRESOR	TR22770	PERKINS 5.8 L DIESEL	
BANDA-ALT	AX69	1997	
TERMOSTATO-180°	33168	BANDA-DH	8600 GS
TERMOSTATO-170°	33167	BANDA-ALT	PQ17530
MANGUERA INFERIOR-	CH-121042	TERMOSTATO-195°	33009
MANGUERA SUPERIOR-	21765	TERMOSTATO-180°	33008
1992		MANGUERA INFERIOR-	CH-120692
BANDA-COMPRESOR	TR22770	MANGUERA SUPERIOR-	CH-122011
BANDA-ALT	AX69	1996	
TERMOSTATO-180°	33168	BANDA-DH	8600 GS
TERMOSTATO-170°	33167	BANDA-ALT	PQ17530
MANGUERA INFERIOR-	CH-121042	TERMOSTATO-195°	33009
MANGUERA SUPERIOR-	21765	TERMOSTATO-180°	33008
1991		MANGUERA INFERIOR-	CH-120692
BANDA-COMPRESOR	TR22770	MANGUERA SUPERIOR-	CH-122011
BANDA-ALT	AX69	1995	
TERMOSTATO-180°	33168	BANDA-DH	8600 GS
TERMOSTATO-170°	33167	BANDA-ALT	PQ17530
MANGUERA INFERIOR-	CH-121042	TERMOSTATO-195°	33009
MANGUERA SUPERIOR-	21765	TERMOSTATO-180°	33008
1990		MANGUERA INFERIOR-	CH-120692
BANDA-COMPRESOR	TR22770	MANGUERA SUPERIOR-	CH-122011
BANDA-ALT	AX69	1994	
TERMOSTATO-180°	33168	BANDA-DH	8600 GS
TERMOSTATO-170°	33167	BANDA-ALT	PQ17530
MANGUERA INFERIOR-	CH-121042	TERMOSTATO-195°	33009
MANGUERA SUPERIOR-	21765	TERMOSTATO-180°	33008
S-500 CORAZA		MANGUERA INFERIOR-	CH-120692
PERKINS T6-354.4		MANGUERA SUPERIOR-	CH-122011
1996		1993	
MANGUERA SUPERIOR-	CH-122011	BANDA-DH	8600 GS
1992		BANDA-ALT	PQ17530
MANGUERA INFERIOR-	CH-120692	TERMOSTATO-195°	33009
1991		TERMOSTATO-180°	33008
MANGUERA INFERIOR-	CH-120692	MANGUERA INFERIOR-	CH-120692
MANGUERA SUPERIOR-	CH-122011	MANGUERA SUPERIOR-	CH-122011
1990		1992	
MANGUERA INFERIOR-	CH-120692	BANDA-DH	8600 GS
MANGUERA SUPERIOR-	CH-122011	BANDA-ALT	PQ17530



TERMOSTATO-195°	33009	BANDA-DH	BX73
TERMOSTATO-180°	33008	BANDA-ALT	9690
MANGUERA INFERIOR-	CH-120692	MANGUERA INFERIOR-	CH-124762
MANGUERA SUPERIOR-	CH-122011	MANGUERA SUPERIOR-	CH-124761
1991		MANGUERA SUPERIOR FLEXIBLE-	22T220
BANDA-DH	8600 GS	1993	
BANDA-ALT	PQ17530	BANDA-VENT	PQ24710
TERMOSTATO-195°	33009	BANDA-DH	BX73
TERMOSTATO-180°	33008	BANDA-ALT	9690
MANGUERA INFERIOR-	CH-120692	MANGUERA INFERIOR-	CH-124762
MANGUERA SUPERIOR-	CH-122011	MANGUERA SUPERIOR-	CH-124761
1990		MANGUERA SUPERIOR FLEXIBLE-	22T220
BANDA-DH	8600 GS	1992	
BANDA-ALT	PQ17530	BANDA-VENT	PQ24710
TERMOSTATO-195°	33009	BANDA-DH	BX73
TERMOSTATO-180°	33008	BANDA-ALT	9690
MANGUERA INFERIOR-	CH-120692	MANGUERA INFERIOR-	CH-124762
MANGUERA SUPERIOR-	CH-122011	MANGUERA SUPERIOR-	CH-124761
S-600			
INTERNATIONAL/NAVISTAR DT466			
1997		MANGUERA SUPERIOR FLEXIBLE-	22T220
BANDA-VENT	PQ24710	1991	
BANDA-DH	BX73	BANDA-VENT	PQ24710
BANDA-ALT	9690	BANDA-DH	BX73
MANGUERA INFERIOR-	CH-124762	BANDA-ALT	9690
MANGUERA SUPERIOR-	CH-124761	MANGUERA INFERIOR-	CH-124762
MANGUERA SUPERIOR FLEXIBLE-	22T220	MANGUERA SUPERIOR-	CH-124761
1996		MANGUERA SUPERIOR FLEXIBLE-	22T220
BANDA-VENT	PQ24710	1990	
BANDA-DH	BX73	BANDA-VENT	PQ24710
BANDA-ALT	9690	BANDA-DH	BX73
MANGUERA INFERIOR-	CH-124762	BANDA-ALT	9690
MANGUERA SUPERIOR-	CH-124761	MANGUERA INFERIOR-	CH-124762
MANGUERA SUPERIOR FLEXIBLE-	22T220	MANGUERA SUPERIOR-	CH-124761
1995		MANGUERA SUPERIOR FLEXIBLE-	22T220
BANDA-VENT	PQ24710	CUMMINS 8.3 L DIESEL	
BANDA-DH	BX73	1997	
BANDA-ALT	9690	BANDA-VENT	PQ24710
MANGUERA INFERIOR-	CH-124762	BANDA-ALT	K080615
MANGUERA SUPERIOR-	CH-124761	MANGUERA INFERIOR-	CH-124832
MANGUERA SUPERIOR FLEXIBLE-	22T220	MANGUERA SUPERIOR-	CH-124831
1994		1996	
BANDA-VENT	PQ24710	BANDA-VENT	PQ24710
		BANDA-ALT	K080615
		MANGUERA INFERIOR-	CH-124832
		MANGUERA SUPERIOR-	CH-124831
		MANGUERA SUPERIOR FLEXIBLE-	22T220
		1995	
		BANDA-VENT	PQ24710
		BANDA-ALT	K080615
		MANGUERA INFERIOR-	CH-124832
		MANGUERA SUPERIOR-	CH-124831
		MANGUERA SUPERIOR FLEXIBLE-	22T220



MASTER SERVICIO PESADO 2014

DINA

S-600

MANGUERA SUPERIOR-	CH-124831	1995	BANDA-VENT	K080570
1995				
BANDA-VENT	PQ24710		BANDA-ALT	K050340
BANDA-ALT	K080615		MANGUERA INFERIOR-	CHARTER 2 1/2"
MANGUERA INFERIOR-	CH-124832		MANGUERA SUPERIOR-	CHARTER 2 1/2"
MANGUERA SUPERIOR-	CH-124831	1994	BANDA-VENT	K080570
1994				
BANDA-VENT	PQ24710		BANDA-ALT	K050340
BANDA-ALT	K080615		MANGUERA INFERIOR-	CHARTER 2 1/2"
MANGUERA INFERIOR-	CH-124832		MANGUERA SUPERIOR-	CHARTER 2 1/2"
MANGUERA SUPERIOR-	CH-124831	1993	BANDA-VENT	K080570
1993				
BANDA-VENT	PQ24710		BANDA-ALT	K050340
BANDA-ALT	K080615		MANGUERA INFERIOR-	CHARTER 2 1/2"
MANGUERA INFERIOR-	CH-124832		MANGUERA SUPERIOR-	CHARTER 2 1/2"
MANGUERA SUPERIOR-	CH-124831	1992	BANDA-VENT	K080570
1992				
BANDA-VENT	PQ24710		BANDA-ALT	K050340
BANDA-ALT	K080615		MANGUERA INFERIOR-	CHARTER 2 1/2"
MANGUERA INFERIOR-	CH-124832		MANGUERA SUPERIOR-	CHARTER 2 1/2"
MANGUERA SUPERIOR-	CH-124831	1991	BANDA-VENT	K080570
1991				
BANDA-VENT	PQ24710		BANDA-ALT	K050340
BANDA-ALT	K080615		MANGUERA INFERIOR-	CHARTER 2 1/2"
MANGUERA INFERIOR-	CH-124832		MANGUERA SUPERIOR-	CHARTER 2 1/2"
MANGUERA SUPERIOR-	CH-124831	1990	BANDA-VENT	K080570
1990				
BANDA-VENT	PQ24710		BANDA-ALT	K050340
BANDA-ALT	K080615		MANGUERA INFERIOR-	CHARTER 2 1/2"
MANGUERA INFERIOR-	CH-124832		MANGUERA SUPERIOR-	CHARTER 2 1/2"
MANGUERA SUPERIOR-	CH-124831			
			CUMMINS 400	
			1997	
			BANDA-VENT	PQ28492
			BANDA-BA	K060445
			BANDA-ALT	PQ17440
			MANGUERA INFERIOR-	CHARTER 2 1/2"
			MANGUERA SUPERIOR-	CHARTER 2 1/2"
			1996	
			BANDA-VENT	PQ28492
			BANDA-BA	K060445
			BANDA-ALT	PQ17440
			MANGUERA INFERIOR-	CHARTER 2 1/2"
			MANGUERA SUPERIOR-	CHARTER 2 1/2"
			1995	

S-700

CUMMINS L10 DIESEL

1997				
BANDA-VENT	K080570			
BANDA-ALT	K050340			
MANGUERA INFERIOR-	CHARTER 2 1/2"			
MANGUERA SUPERIOR-	CHARTER 2 1/2"			
1996				
BANDA-VENT	K080570			
BANDA-ALT	K050340			
MANGUERA INFERIOR-	CHARTER 2 1/2"			
MANGUERA SUPERIOR-	CHARTER 2 1/2"			



MASTER SERVICIO PESADO 2014

DINA

S-700

BANDA-VENT	PQ28492	BANDA-DH	PQ28501
BANDA-BA	K060445	BANDA-BA	K060436
BANDA-ALT	PQ17440	BANDA-ALT	PQ17460
MANGUERA INFERIOR-	CHARTER 2 1/2"	MANGUERA INFERIOR-	CHARTER 2 1/2"
MANGUERA SUPERIOR-	CHARTER 2 1/2"	MANGUERA SUPERIOR-	CHARTER 2 1/2"
1994		1995	
BANDA-VENT	PQ28492	BANDA-DH	PQ28501
BANDA-BA	K060445	BANDA-BA	K060436
BANDA-ALT	PQ17440	BANDA-ALT	PQ17460
MANGUERA INFERIOR-	CHARTER 2 1/2"	MANGUERA INFERIOR-	CHARTER 2 1/2"
MANGUERA SUPERIOR-	CHARTER 2 1/2"	MANGUERA SUPERIOR-	CHARTER 2 1/2"
1993		1994	
BANDA-VENT	PQ28492	BANDA-DH	PQ28501
BANDA-BA	K060445	BANDA-BA	K060436
BANDA-ALT	PQ17440	BANDA-ALT	PQ17460
MANGUERA INFERIOR-	CHARTER 2 1/2"	MANGUERA INFERIOR-	CHARTER 2 1/2"
MANGUERA SUPERIOR-	CHARTER 2 1/2"	MANGUERA SUPERIOR-	CHARTER 2 1/2"
1992		1993	
BANDA-VENT	PQ28492	BANDA-DH	PQ28501
BANDA-BA	K060445	BANDA-BA	K060436
BANDA-ALT	PQ17440	BANDA-ALT	PQ17460
MANGUERA INFERIOR-	CHARTER 2 1/2"	MANGUERA INFERIOR-	CHARTER 2 1/2"
MANGUERA SUPERIOR-	CHARTER 2 1/2"	MANGUERA SUPERIOR-	CHARTER 2 1/2"
1991		1992	
BANDA-VENT	PQ28492	BANDA-DH	PQ28501
BANDA-BA	K060445	BANDA-BA	K060436
BANDA-ALT	PQ17440	BANDA-ALT	PQ17460
MANGUERA INFERIOR-	CHARTER 2 1/2"	MANGUERA INFERIOR-	CHARTER 2 1/2"
MANGUERA SUPERIOR-	CHARTER 2 1/2"	MANGUERA SUPERIOR-	CHARTER 2 1/2"
1990		1991	
BANDA-VENT	PQ28492	BANDA-DH	PQ28501
BANDA-BA	K060445	BANDA-BA	K060436
BANDA-ALT	PQ17440	BANDA-ALT	PQ17460
MANGUERA INFERIOR-	CHARTER 2 1/2"	MANGUERA INFERIOR-	CHARTER 2 1/2"
MANGUERA SUPERIOR-	CHARTER 2 1/2"	MANGUERA SUPERIOR-	CHARTER 2 1/2"
CUMMINS 350		1990	
1997		BANDA-DH	PQ28501
BANDA-DH	PQ28501	BANDA-BA	K060436
BANDA-BA	K060436	BANDA-ALT	PQ17460
BANDA-ALT	PQ17460	MANGUERA INFERIOR-	CHARTER 2 1/2"
MANGUERA INFERIOR-	CHARTER 2 1/2"	MANGUERA SUPERIOR-	CHARTER 2 1/2"
MANGUERA SUPERIOR-	CHARTER 2 1/2"		
1996		URBANO	
		CATERPILLAR 3126 DIESEL	



MASTER SERVICIO PESADO 2014

DINA

URBANO

2000

BANDA-VENT

K080730

MANGUERA INFERIOR-

CH-120192

1999

BANDA-VENT

K080730

MANGUERA INFERIOR-

CH-120192

1998

BANDA-VENT

K080730

MANGUERA INFERIOR-

CH-120192

1997

BANDA-VENT

K080730

MANGUERA INFERIOR-

CH-120192

1996

BANDA-VENT

K080730

MANGUERA INFERIOR-

CH-120192

DODGE



DODGE

D-600

DODGE V8, 6.0 L

1993

MANGUERA INFERIOR-

CH-114602

MANGUERA SUPERIOR-

CH-114601

1992

MANGUERA INFERIOR-

CH-114602

MANGUERA SUPERIOR-

CH-114601

DODGE V8, 5.9 L

1994

BANDA-DH

PQ17450

BANDA-COMPRESOR

AX69

BANDA-ALT

6607 GS

MANGUERA INFERIOR-

CH-114592

MANGUERA SUPERIOR-

CH-114591

1993

BANDA-DH

PQ17450

BANDA-COMPRESOR

AX69

BANDA-ALT

6607 GS

MANGUERA INFERIOR-

CH-114592

MANGUERA SUPERIOR-

CH-114591

1992

BANDA-COMPRESOR

AX69

1991

BANDA-COMPRESOR

AX69

1990

BANDA-COMPRESOR

AX69

RAM-4000

V6, 6.7 L DIESEL

2013

BANDA-MOTOR

K081102

BANDA-MOTOR

K081264

POLEA-MOTOR

36315

TENSOR-MOTOR

38285

TERMOSTATO-200°

34212

TERMOSTATO-190°

34219

TERMOSTATO-180°

34218

TAPÓN DE RADIADOR-(16 LBS) SIN PALANCA

31528

BOMBA DE AGUA-

42291HD

MANGUERA DE CALEFACCIÓN-

18710

MANGUERA INFERIOR-

23956

MANGUERA SUPERIOR-

23955

2012

BANDA-MOTOR

K081102

BANDA-MOTOR

K081264

POLEA-MOTOR

36315

TENSOR-MOTOR

38285

TERMOSTATO-200°

34212

TERMOSTATO-190°

34219

TERMOSTATO-180°

34218

TAPÓN DE RADIADOR-(16 LBS) SIN PALANCA

31528

BOMBA DE AGUA-

42291HD

MANGUERA DE CALEFACCIÓN-

18710

MANGUERA INFERIOR-

23956

MANGUERA SUPERIOR-

23955

2011

TAPÓN DE GASOLINA-SIN LLAVE

31838

BANDA-MOTOR

K081102

BANDA-MOTOR

K081264

POLEA-MOTOR

36315

TENSOR-MOTOR

38285

TAPÓN DE GASOLINA-CON LLAVE

31836

TERMOSTATO-195°

33915

TAPÓN DE RADIADOR-(16 LBS) SIN PALANCA

31528

BOMBA DE AGUA-

42291HD

MANGUERA DE CALEFACCIÓN-

18710

MANGUERA DE CALEFACCIÓN-

18774

MANGUERA INFERIOR-

22893



MASTER SERVICIO PESADO 2014

DODGE

RAM-4000

MANGUERA SUPERIOR-	22892	MANGUERA DE CALEFACCIÓN-	18774
TAPÓN DE ACEITE-	31118	MANGUERA INFERIOR-	22893
2010		MANGUERA SUPERIOR-	22892
TAPÓN DE GASOLINA-SIN LLAVE	31838	TAPÓN DE ACEITE-	31118
BANDA-MOTOR	K081102	V6, 5.9 L DIESEL	
BANDA-MOTOR	K081264	2008	
POLEA-MOTOR	36315	TAPÓN DE GASOLINA-SIN LLAVE	31838
TENSOR-MOTOR	38285	BANDA-MOTOR	K081102
TAPÓN DE GASOLINA-CON LLAVE	31836	BANDA-MOTOR	K081264
TERMOSTATO-195°	33915	POLEA-MOTOR	36315
TAPÓN DE RADIADOR-(16 LBS) SIN PALANCA	31528	TENSOR-MOTOR	38285
BOMBA DE AGUA-	42291HD	TAPÓN DE GASOLINA-CON LLAVE	31836
MANGUERA DE CALEFACCIÓN-	18710	TERMOSTATO-195°	33915
MANGUERA DE CALEFACCIÓN-	18774	TAPÓN DE RADIADOR-(16 LBS) SIN PALANCA	31528
MANGUERA INFERIOR-	22893	BOMBA DE AGUA-	43526HD
MANGUERA SUPERIOR-	22892	MANGUERA INFERIOR-	22893
TAPÓN DE ACEITE-	31118	MANGUERA SUPERIOR-	22892
2009		TAPÓN DE ACEITE-	31118
TAPÓN DE GASOLINA-SIN LLAVE	31838	2007	
BANDA-MOTOR	K081102	TAPÓN DE GASOLINA-SIN LLAVE	31838
BANDA-MOTOR	K081264	BANDA-MOTOR	K081102
POLEA-MOTOR	36315	BANDA-MOTOR	K081265
TENSOR-MOTOR	38285	TENSOR-MOTOR	38285
TAPÓN DE GASOLINA-CON LLAVE	31836	TERMOSTATO-195°	14289
TERMOSTATO-195°	33915	BOMBA DE AGUA-	43526HD
TAPÓN DE RADIADOR-(16 LBS) SIN PALANCA	31528	KIT MICRO-V-	DBK081102
BOMBA DE AGUA-	42291HD	KIT MICRO-V-	DBK081265
MANGUERA DE CALEFACCIÓN-	18710	MANGUERA INFERIOR-	22893
MANGUERA DE CALEFACCIÓN-	18774	MANGUERA SUPERIOR-	22892
MANGUERA INFERIOR-	22893	TAPÓN DE ACEITE-	31118
MANGUERA SUPERIOR-	22892	2006	
TAPÓN DE ACEITE-	31118	TAPÓN DE GASOLINA-SIN LLAVE	31838
2008		BANDA-MOTOR	K081102
TAPÓN DE GASOLINA-SIN LLAVE	31838	BANDA-MOTOR	K081265
BANDA-MOTOR	K081102	TENSOR-MOTOR	38285
BANDA-MOTOR	K081264	TERMOSTATO-195°	14289
POLEA-MOTOR	36315	BOMBA DE AGUA-	43526HD
TENSOR-MOTOR	38285	KIT MICRO-V-	DBK081102
TAPÓN DE GASOLINA-CON LLAVE	31836	KIT MICRO-V-	DBK081265
TERMOSTATO-195°	33915	MANGUERA INFERIOR-	22893
TAPÓN DE RADIADOR-(16 LBS) SIN PALANCA	31528	MANGUERA SUPERIOR-	22892
BOMBA DE AGUA-	42291HD	TAPÓN DE ACEITE-	31118
MANGUERA DE CALEFACCIÓN-	18710	2005	



MASTER SERVICIO PESADO 2014

DODGE

RAM-4000

TAPÓN DE GASOLINA-SIN LLAVE	31838	BANDA-MOTOR	K071040
BANDA-MOTOR	K081102	POLEA-MOTOR	38016
BANDA-MOTOR	K081265	TENSOR-MOTOR	38116
TENSOR-MOTOR	38285	MANGUERA MOLDEADA-MANGUERA SUPERIOR	CH-115591
TERMOSTATO-195°	14289	MANGUERA MOLDEADA-MANGUERA INFERIOR	CH-117592
BOMBA DE AGUA-	43526HD	2000	
KIT MICRO-V-	DBK081102	BANDA-MOTOR	K070880
KIT MICRO-V-	DBK081265	BANDA-MOTOR	K070975
MANGUERA INFERIOR-	22893	BANDA-MOTOR	K071040
MANGUERA SUPERIOR-	22892	BANDA-MOTOR	K071130
TAPÓN DE ACEITE-	31118	POLEA-MOTOR	38016
2004		TENSOR-MOTOR	38116
TAPÓN DE GASOLINA-SIN LLAVE	31838	MANGUERA MOLDEADA-MANGUERA SUPERIOR	CH-115591
BANDA-MOTOR	K081102	MANGUERA MOLDEADA-MANGUERA INFERIOR	CH-117592
BANDA-MOTOR	K081265	1999	
TENSOR-MOTOR	38285	BANDA-MOTOR	K070880
TERMOSTATO-195°	14289	BANDA-MOTOR	K070975
KIT MICRO-V-	DBK081102	BANDA-MOTOR	K071040
KIT MICRO-V-	DBK081265	BANDA-MOTOR	K071130
MANGUERA INFERIOR-	22893	POLEA-MOTOR	38016
MANGUERA SUPERIOR-	22892	TENSOR-MOTOR	38116
TAPÓN DE ACEITE-	31118	MANGUERA MOLDEADA-MANGUERA SUPERIOR	CH-115591
2003		MANGUERA MOLDEADA-MANGUERA INFERIOR	CH-117592
TAPÓN DE GASOLINA-SIN LLAVE	31838	1998	
BANDA-MOTOR	K081102	BANDA-MOTOR	K070880
BANDA-MOTOR	K081265	BANDA-MOTOR	K070975
TENSOR-MOTOR	38285	BANDA-MOTOR	K071040
TERMOSTATO-195°	14289	BANDA-MOTOR	K071130
KIT MICRO-V-	DBK081102	POLEA-MOTOR	38016
KIT MICRO-V-	DBK081265	TENSOR-MOTOR	38116
MANGUERA INFERIOR-	22893	MANGUERA MOLDEADA-MANGUERA SUPERIOR	CH-115591
MANGUERA SUPERIOR-	22892	MANGUERA MOLDEADA-MANGUERA INFERIOR	CH-117592
TAPÓN DE ACEITE-	31118	1997	
2002		BANDA-S/AA VIN Z	K070880
BANDA-MOTOR	K070975	BANDA-S/AA VIN 5	K071040
BANDA-MOTOR	K080810	TENSOR-MOTOR	38116
POLEA-MOTOR	38016	MANGUERA INFERIOR-C/AA, C/DH	CH-117592
TENSOR-MOTOR	38116	MANGUERA SUPERIOR-C/AA, C/DH	CH-115591
MANGUERA DE PASO-	22038	BANDA-C/AA VIN Z	K070975
MANGUERA INFERIOR-	22083	BANDA-C/AA VIN 5	K071130
MANGUERA SUPERIOR-	22043	POLEA-	38016
2001		1996	
BANDA-MOTOR	K070880	TAPÓN DE GASOLINA-SIN LLAVE C/CONT. DE EMISION	31615



MASTER SERVICIO PESADO 2014

DODGE

RAM-4000

BANDA-S/AA VIN 5	K071040	BANDA-ALT-BA-COMPRESOR-VENT-AA	K081213
BANDA-S/AA	K071045	MANGUERA SUPERIOR-	22312
MANGUERA INFERIOR-C/AA, C/DH	CH-117592	POLEA DEL TENSOR-	38028
MANGUERA SUPERIOR-C/AA, C/DH	CH-115591	POLEA DEL TENSOR-	38053
BANDA-C/AA, C/COMP	K071141	2002	
POLEA-	38016	MANGUERA INFERIOR-MOTOR A RAD	22319
1995		BANDA-ALT-BA-VENT-AA-C/DOBLE ALT	K081359
BANDA-S/AA VIN 5	K071040	BANDA-ALT-BA-VENT-AA-1 ALT	K081207
BANDA-S/AA	K071045	BANDA-ALT-BA-COMPRESOR-VENT-AA	K081213
TENSOR-MOTOR	38116	MANGUERA SUPERIOR-	22312
MANGUERA INFERIOR-C/AA, C/DH	CH-117592	POLEA DEL TENSOR-	38028
MANGUERA SUPERIOR-C/AA, C/DH	CH-115591	POLEA DEL TENSOR-	38053
BANDA-C/AA, C/COMP	K071141	2001	
POLEA-	38016	BANDA-ALT-BA-COMPRESOR-VENT-AA	K081213

RAM-6500

V8, 5.9 L

1997		TERMOSTATO-195°	33909
BANDA-C/DH	K071157	MANGUERA INFERIOR-	22319
MANGUERA INFERIOR-	CH-112592	MANGUERA SUPERIOR-	22312
MANGUERA SUPERIOR-	CH-112591	POLEA DEL TENSOR-	38028
1996		POLEA DEL TENSOR-	38053
BANDA-C/DH	K071157	2000	
MANGUERA INFERIOR-	CH-112592	BANDA-ALT-BA-COMPRESOR-VENT-AA	K081213
MANGUERA SUPERIOR-	CH-112591	MANGUERA INFERIOR-	22319
1995		MANGUERA SUPERIOR-	22312
BANDA-VENT	BX55	POLEA DEL TENSOR-	38028
BANDA-C/DH	K071157	POLEA DEL TENSOR-	38053
MANGUERA INFERIOR-	CH-112592	1999	
MANGUERA SUPERIOR-	CH-112591	BANDA-ALT-BA-COMPRESOR-VENT-AA	K081213
1994		MANGUERA INFERIOR-	22319
BANDA-C/DH	K071157	MANGUERA SUPERIOR-	22312
MANGUERA INFERIOR-	CH-112592	POLEA DEL TENSOR-	38028
MANGUERA SUPERIOR-	CH-112591	POLEA DEL TENSOR-	38053
1998		MANGUERA DE ENFRIAMIENTO-TUBO A RAD.	28467
BANDA-C/DH	K071157	MANGUERA DE AGUA-TUBO A MOTOR	30T 5/8"
MANGUERA INFERIOR-	CH-112592	MANGUERA DE CALEFACCIÓN-TUBO 2 A BA	18703
MANGUERA SUPERIOR-	CH-112591	MANGUERA DE CALEFACCIÓN-TUBO 1 A TUBO 3	18785

FORD



E450 SUPER DUTY

FORD V8, 7.3 L DIESEL

2003		TAPÓN DE GASOLINA-SIN LLAVE C/CONT. DE EMISIÓN	31615
MANGUERA INFERIOR-MOTOR A RAD	22319	TAPÓN DE GASOLINA-SIN LLAVE	31830
BANDA-ALT-BA-VENT-AA-C/DOBLE ALT	K081359	MANGUERA DE CALEFACCIÓN-MOTOR	19180
BANDA-ALT-BA-VENT-AA-1 ALT	K081207	TAPÓN DE GASOLINA-CON LLAVE C/CONT. DE EMISIÓN	31734
		TAPÓN DE GASOLINA-CON LLAVE	31828
		MANGUERA DE CALEFACCIÓN-CALEFACTOR A TUBO-2	28467
		MANGUERA DE CALEFACCIÓN-CALEFACTOR A TUBO-1	28467



MASTER SERVICIO PESADO 2014

FORD

E450 SUPER DUTY

BANDA-C/DOBLE ALT	K081359	BANDA-C/AA	K060990
TERMOSTATO-195°	33909	TAPÓN DE RADIADOR-(16 LBS) SIN PALANCA	31406
TAPÓN DE RADIADOR-(16 LBS) SIN PALANCA	31406	TAPÓN DE ACEITE-	31109
BANDA-	K081177	2004	
BANDA-	K081196	BANDA-S/AA	K060806
BANDA-	K081213	TENSOR-MOTOR	38274
MANGUERA DE AGUA-	30T 5/8"	BANDA-C/AA	K060990
MANGUERA INFERIOR-	22319	TAPÓN DE RADIADOR-(16 LBS) SIN PALANCA	31406
MANGUERA SUPERIOR-	22312	TAPÓN DE ACEITE-	31109
POLEA DEL TENSOR-	38028	2003	
POLEA DEL TENSOR-	38053	TAPÓN DE GASOLINA-SIN LLAVE	31830
TAPÓN DE ACEITE-	31109	BANDA-S/AA	K060806
FORD V8, 6.0 L DIESEL		TENSOR-MOTOR	38274
2006		TAPÓN DE GASOLINA-CON LLAVE	31828
MANGUERA SUPERIOR-MOTOR A RAD.	23077	BANDA-C/AA	K060990
MANGUERA INFERIOR-MOTOR A RAD	23076	TERMOSTATO-195°	33469
BANDA-ALT-DH-VENT-AA-C/DOBLE ALT	K081359	TERMOSTATO-180°	33468
BANDA-ALT-DH-VENT-AA-1ALT	K081298	TAPÓN DE RADIADOR-(16 LBS) SIN PALANCA	31406
TENSOR-ALT-DH-VENT-AA	38257	MANGUERA INFERIOR-	22297
BANDA-ALT-C/DOBLE ALT	K060658	MANGUERA SUPERIOR-	22315
2005		TAPÓN DE ACEITE-	31109
MANGUERA SUPERIOR-MOTOR A RAD.	23077	2002	
MANGUERA INFERIOR-MOTOR A RAD	23076	MANGUERA DE CALEFACCIÓN-TOMA DE MÚLTIPLE	19277
BANDA-ALT-DH-VENT-AA-C/DOBLE ALT	K081359	TAPÓN DE GASOLINA-SIN LLAVE	31830
BANDA-ALT-DH-VENT-AA-1ALT	K081298	BANDA-S/AA	K060806
TENSOR-ALT-DH-VENT-AA	38257	TENSOR-MOTOR	38274
BANDA-ALT-C/DOBLE ALT	K060658	MANGUERA DE ENFRIAMIENTO-DEPÓSITO A RAD.	35B 3/8"
2004		TAPÓN DE GASOLINA-CON LLAVE	31828
BANDA-ALT-DH-VENT-AA-C/DOBLE ALT	K081359	MANGUERA DE CALEFACCIÓN-CALEFACCIÓN-TUBO1	19191
BANDA-ALT-DH-VENT-AA-1ALT	K081298	BANDA-C/AA	K060990
TENSOR-ALT-DH-VENT-AA	38257	TERMOSTATO-195°	33469
BANDA-ALT-C/DOBLE ALT	K060658	TERMOSTATO-180°	33468
2003		TAPÓN DE RADIADOR-(16 LBS) SIN PALANCA	31406
BANDA-ALT-DH-VENT-AA-C/DOBLE ALT	K081359	MANGUERA SUPERIOR-	22315
BANDA-ALT-DH-VENT-AA-1ALT	K081298	TAPÓN DE ACEITE-	31109
TENSOR-ALT-DH-VENT-AA	38257	2001	
BANDA-ALT-C/DOBLE ALT	K060658	MANGUERA DE CALEFACCIÓN-TOMA DE MÚLTIPLE	19277
FORD V8, 5.4 L		TAPÓN DE GASOLINA-SIN LLAVE	31830
2005		TAPÓN DE GASOLINA-SIN LLAVE	31831
TAPÓN DE GASOLINA-SIN LLAVE	31841	BANDA-S/AA	K080806
BANDA-S/AA	K060806	TENSOR-MOTOR	38133
TENSOR-MOTOR	38329	TAPÓN DE GASOLINA-CON LLAVE	31828
TAPÓN DE GASOLINA-CON LLAVE	31842	TAPÓN DE GASOLINA-CON LLAVE	31834



MASTER SERVICIO PESADO 2014

FORD

E450 SUPER DUTY

MANGUERA DE CALEFACCIÓN-CALEFACCIÓN-TUBO1	19191	TENSOR-MOTOR	38329
BANDA-C/AA	K080991	BANDA-C/AA	K060997
TERMOSTATO-195°	33469	MANGUERA SUPERIOR-	22315
TERMOSTATO-180°	33468	POLEA DEL TENSOR-	38006
TAPÓN DE RADIADOR-(16 LBS) SIN PALANCA	31406	2007	
MANGUERA INFERIOR-	22318	BANDA-S/AA	K060806
MANGUERA SUPERIOR-	22315	POLEA-MOTOR	36157
POLEA-	38022	POLEA-MOTOR	38001
POLEA DEL TENSOR-	38023	TENSOR-MOTOR	38274
TAPÓN DE ACEITE-	31109	TENSOR-MOTOR	38329
2000		BANDA-C/AA	K060997
MANGUERA DE CALEFACCIÓN-TOMA DE MÚLTIPLE	19277	MANGUERA SUPERIOR-	22315
MANGUERA DE CALEFACCIÓN-TOMA DE MÚLTIPLE	22614	POLEA DEL TENSOR-	38006
TAPÓN DE GASOLINA-SIN LLAVE	31830	2006	
BANDA-S/AA	K080806	BANDA-S/AA	K060806
TENSOR-MOTOR	38133	POLEA-MOTOR	36157
TAPÓN DE GASOLINA-CON LLAVE	31828	POLEA-MOTOR	38001
MANGUERA DE CALEFACCIÓN-CALEFACCIÓN-TUBO1	19191	TENSOR-MOTOR	38274
MANGUERA DE CALEFACCIÓN-CALEFACCIÓN-TUBO1	22624	TENSOR-MOTOR	38329
BANDA-C/AA	K080991	BANDA-C/AA	K060990
TERMOSTATO-195°	33469	BANDA-ALT-DH-VENT-AA	K060984
TERMOSTATO-180°	33468	MANGUERA SUPERIOR-	22315
TAPÓN DE RADIADOR-(16 LBS) SIN PALANCA	31406	2005	
MANGUERA INFERIOR-	22318	TENSOR-MOTOR	38133
MANGUERA SUPERIOR-	22315	TENSOR-MOTOR	38330
POLEA-	38022	BANDA-ALT-DH-VENT-AA	K060990
POLEA DEL TENSOR-	38023	POLEA-	38001
TAPÓN DE ACEITE-	31109	POLEA DEL TENSOR-	38023
FORD V10, 6.8 L		2004	
2009		TENSOR-MOTOR	38133
BANDA-S/AA	K060806	TENSOR-MOTOR	38330
POLEA-MOTOR	36157	BANDA-ALT-DH-VENT-AA	K060990
POLEA-MOTOR	38001	POLEA-	38001
TENSOR-MOTOR	38274	POLEA DEL TENSOR-	38023
TENSOR-MOTOR	38329	2003	
BANDA-C/AA	K060997	BANDA-S/AA	K060806
MANGUERA SUPERIOR-	22315	TENSOR-MOTOR	38133
POLEA DEL TENSOR-	38006	TENSOR-MOTOR	38330
2008		BANDA-C/AA	K060990
BANDA-S/AA	K060806	MANGUERA SUPERIOR-	22315
POLEA-MOTOR	36157	POLEA-	38001
POLEA-MOTOR	38001	POLEA DEL TENSOR-	38023
TENSOR-MOTOR	38274	2002	



MASTER SERVICIO PESADO 2014

FORD

E450 SUPER DUTY

MANGUERA DE CALEFACCIÓN-TOMA DE MÚLTIPLE	19277	MANGUERA INFERIOR-MOTOR A RAD	22319
BANDA-S/AA	K060806	BANDA-ALT-BA-VENT-AA	K081223
TENSOR-MOTOR	38133	BANDA-ALT-BA-COMPRESOR-VENT-AA	K081213
TENSOR-MOTOR	38330	MANGUERA SUPERIOR-	22312
MANGUERA DE CALEFACCIÓN-CALEFACCIÓN-TUBO1	19191	POLEA DEL TENSOR-	38028
BANDA-C/AA	K060990	POLEA DEL TENSOR-	38053
TERMOSTATO-195°	33469	2002	
TERMOSTATO-180°	33468	MANGUERA INFERIOR-MOTOR A RAD	22319
MANGUERA SUPERIOR-	22315	BANDA-ALT-BA-VENT-AA	K081223
POLEA-	38001	BANDA-ALT-BA-COMPRESOR-VENT-AA	K081213
POLEA DEL TENSOR-	38023	MANGUERA SUPERIOR-	22312
2001		POLEA DEL TENSOR-	38028
MANGUERA DE CALEFACCIÓN-TOMA DE MÚLTIPLE	19277	POLEA DEL TENSOR-	38053
TENSOR-MOTOR	38133	FORD V10, 6.8 L	
TENSOR-MOTOR	38330	2003	
MANGUERA DE CALEFACCIÓN-CALEFACCIÓN-TUBO1	19191	MANGUERA DE CALEFACCIÓN-TOMA DE MÚLTIPLE	19277
BANDA-ALT-DH-VENT-AA	K080991	BANDA-S/AA	K060806
BANDA-ALT-DH-VENT	K080806	TENSOR-MOTOR	38133
MANGUERA INFERIOR-	22371	TENSOR-MOTOR	38330
MANGUERA SUPERIOR-	22316	MANGUERA DE CALEFACCIÓN-CALEFACCIÓN-TUBO1	19191
POLEA-	38022	BANDA-C/AA	K060990
POLEA DEL TENSOR-	38023	TERMOSTATO-195°	33469
2000		TERMOSTATO-180°	33468
TENSOR-MOTOR	38133	MANGUERA SUPERIOR-	22315
TENSOR-MOTOR	38330	POLEA-	38001
BANDA-ALT-DH-VENT-AA	K080991	POLEA DEL TENSOR-	38023
BANDA-ALT-DH-VENT	K080806	2002	
MANGUERA INFERIOR-	22371	MANGUERA DE CALEFACCIÓN-TOMA DE MÚLTIPLE	19277
MANGUERA SUPERIOR-	22316	BANDA-S/AA	K060806
POLEA-	38022	TENSOR-MOTOR	38133
POLEA DEL TENSOR-	38023	TENSOR-MOTOR	38330
1999		MANGUERA DE CALEFACCIÓN-CALEFACCIÓN-TUBO1	19191
TENSOR-MOTOR	38133	BANDA-C/AA	K060990
TENSOR-MOTOR	38330	TERMOSTATO-195°	33469
BANDA-ALT-DH-VENT-AA	K080991	TERMOSTATO-180°	33468
BANDA-ALT-DH-VENT	K080806	MANGUERA SUPERIOR-	22315
MANGUERA INFERIOR-	22371	POLEA-	38001
MANGUERA SUPERIOR-	22316	POLEA DEL TENSOR-	38023
POLEA-	38022	F-350 SUPER DUTY	
POLEA DEL TENSOR-	38023	V8, 5.4 L	
E550 SUPER DUTY		2004	
FORD V8, 7.3 L DIESEL		MANGUERA DE ENFRIAMIENTO-	22429
2003		MANGUERA DE ENFRIAMIENTO-	22430



MASTER SERVICIO PESADO 2014

FORD

F-350 SUPER DUTY

2003			MANGUERA DE CALEFACCIÓN-BA	19201
BANDA-S/AA	K060806		BANDA-1 ALTERNADOR	K081223
BANDA-C/AA	K060997		BANDA-	K081213
MANGUERA INFERIOR-	22430		MANGUERA INFERIOR-	22690
V10, 6.8 L			MANGUERA SUPERIOR-	22433
2004			MANGUERA SUPERIOR-	22542
MANGUERA DE ENFRIAMIENTO-	22431		POLEA DEL TENSOR-	38028
MANGUERA DE ENFRIAMIENTO-	22432		POLEA DEL TENSOR-	38053
2003			2001	
BANDA-S/AA	K060806		MANGUERA DE ENFRIAMIENTO-RAD. A DEPÓSITO	35B 3/8"
BANDA-C/AA	K060997		MANGUERA DE CALEFACCIÓN-MOTOR	19200
MANGUERA DE ENFRIAMIENTO-	22432		TENSOR-MOTOR	38191
F-450 SUPER DUTY			MANGUERA SUPERIOR-DEPÓSITO A RAD.	19812
V8, 5.4 L			BANDA-C/DOBLE ALT	K081377
2004			MANGUERA DE CALEFACCIÓN-BA	19201
BANDA-S/AA	K060806		BANDA-1 ALTERNADOR	K081223
BANDA-C/AA	K060997		MANGUERA INFERIOR-	22690
MANGUERA INFERIOR-	22430		MANGUERA SUPERIOR-	22433
2003			MANGUERA SUPERIOR-	22542
BANDA-S/AA	K060806		POLEA DEL TENSOR-	38028
BANDA-C/AA	K060997		POLEA DEL TENSOR-	38053
MANGUERA INFERIOR-	22430		2000	
FORD V8, 7.3 L DIESEL			MANGUERA DE ENFRIAMIENTO-RAD. A DEPÓSITO	35B 3/8"
2003			MANGUERA DE CALEFACCIÓN-MOTOR	19200
MANGUERA DE ENFRIAMIENTO-RAD. A DEPÓSITO	35B 3/8"		TENSOR-MOTOR	38191
MANGUERA DE CALEFACCIÓN-MOTOR	19200		MANGUERA SUPERIOR-DEPÓSITO A RAD.	19812
TENSOR-MOTOR	38191		BANDA-C/DOBLE ALT	K081377
MANGUERA SUPERIOR-DEPÓSITO A RAD.	19812		MANGUERA DE CALEFACCIÓN-BA	19201
BANDA-C/DOBLE ALT	K081377		BANDA-ALT-DH-VENT-AA	K081223
MANGUERA DE CALEFACCIÓN-BA	19201		BANDA-1 ALTERNADOR	K081223
BANDA-1 ALTERNADOR	K081223		MANGUERA INFERIOR-	22434
BANDA-	K081213		MANGUERA SUPERIOR-	22433
MANGUERA INFERIOR-	22690		POLEA DEL TENSOR-	38028
MANGUERA SUPERIOR-	22433		POLEA DEL TENSOR-	38053
MANGUERA SUPERIOR-	22542		1999	
POLEA DEL TENSOR-	38028		TENSOR-MOTOR	38191
POLEA DEL TENSOR-	38053		BANDA-ALT-DH-VENT-AA	K081223
2002			TERMOSTATO-195°	33909
MANGUERA DE ENFRIAMIENTO-RAD. A DEPÓSITO	35B 3/8"		MANGUERA INFERIOR-	22434
MANGUERA DE CALEFACCIÓN-MOTOR	19200		MANGUERA SUPERIOR-	22433
TENSOR-MOTOR	38191		MANGUERA SUPERIOR-	22542
MANGUERA SUPERIOR-DEPÓSITO A RAD.	19812		POLEA DEL TENSOR-	38028
BANDA-C/DOBLE ALT	K081377		POLEA DEL TENSOR-	38053



MASTER SERVICIO PESADO 2014

FORD

F-450 SUPER DUTY

FORD V8, 6.0 L DIESEL

2007

BANDA-ALT-DH-VENT-AA-C/DOBLE ALT	K081325
BANDA-ALT-DH-VENT-AA-1ALT	K081265
TENSOR-ALT-DH-VENT-AA	38257
BANDA-ALT-C/DOBLE ALT	K060658

2006

MANGUERA INFERIOR-MOTOR A RAD.	22780
MANGUERA SUPERIOR-MOTOR A RAD.	22779
BANDA-ALT-DH-VENT-AA-C/DOBLE ALT	K081325
BANDA-ALT-DH-VENT-AA-1ALT	K081265
BANDA-ALT-DH-VENT-AA	K081265
TENSOR-ALT-DH-VENT-AA	38257
BANDA-ALT-C/DOBLE ALT	K060658
TAPÓN DE RADIADOR-(16 LBS) SIN PALANCA	31406

2005

MANGUERA INFERIOR-MOTOR A RAD.	22780
MANGUERA SUPERIOR-MOTOR A RAD.	22779
MANGUERA INFERIOR-MOTOR A RAD	22780
BANDA-ALT-DH-VENT-AA-C/DOBLE ALT	K081325
BANDA-ALT-DH-VENT-AA-1ALT	K081265
BANDA-ALT-DH-VENT-AA	K081265
TENSOR-ALT-DH-VENT-AA	38257
BANDA-ALT-C/DOBLE ALT	K060658

2004

MANGUERA SUPERIOR-MOTOR A RAD.	22779
MANGUERA INFERIOR-MOTOR A RAD	22780
BANDA-ALT-DH-VENT-AA-C/DOBLE ALT	K081325
BANDA-ALT-DH-VENT-AA-1ALT	K081265
TENSOR-ALT-DH-VENT-AA	38257
BANDA-ALT-C/DOBLE ALT	K060658
TERMOSTATO-190°	33958

2003

MANGUERA SUPERIOR-MOTOR A RAD.	22779
MANGUERA INFERIOR-MOTOR A RAD	22780
BANDA-ALT-DH-VENT-AA-C/DOBLE ALT	K081325
BANDA-ALT-DH-VENT-AA-1ALT	K081265
TENSOR-ALT-DH-VENT-AA	38257
BANDA-ALT-C/DOBLE ALT	K060658

FORD V10, 6.8 L

2006

BANDA-S/AA	K060806
POLEA-MOTOR	36157

POLEA-MOTOR	38001
TENSOR-MOTOR	38274
TENSOR-MOTOR	38329
BANDA-C/AA	K060997
TAPÓN DE RADIADOR-(16 LBS) SIN PALANCA	31406

2005

BANDA-S/AA	K060806
POLEA-MOTOR	36157
POLEA-MOTOR	38001
TENSOR-MOTOR	38274
TENSOR-MOTOR	38329
BANDA-C/AA	K061000
TAPÓN DE RADIADOR-(16 LBS) SIN PALANCA	31406
MANGUERA INFERIOR-	22432
MANGUERA SUPERIOR-	22431

2004

MANGUERA DE CALEFACCIÓN-TOMA DE MÚLTIPLE	19218
TAPÓN DE GASOLINA-SIN LLAVE C/CONT. DE EMISIÓN	31615
TAPÓN DE GASOLINA-SIN LLAVE	31830
BANDA-S/AA	K060806
POLEA-MOTOR	36157
POLEA-MOTOR	38001
TENSOR-MOTOR	38274
TENSOR-MOTOR	38329
MANGUERA SUPERIOR-DEPÓSITO A RAD.	19812
TAPÓN DE GASOLINA-CON LLAVE C/CONT. DE EMISIÓN	31734
TAPÓN DE GASOLINA-CON LLAVE	31828
MANGUERA DE CALEFACCIÓN-CALEFACCIÓN-TUBO1	19306
BANDA-C/AA	K061000
TERMOSTATO-195°	33469
TERMOSTATO-180°	33468
TAPÓN DE RADIADOR-(16 LBS) SIN PALANCA	31406
MANGUERA INFERIOR-	22432
MANGUERA SUPERIOR-	22431
TAPÓN DE ACEITE-	31109

2003

MANGUERA DE CALEFACCIÓN-TOMA DE MÚLTIPLE	19218
BANDA-S/AA	K060806
POLEA-MOTOR	36157
POLEA-MOTOR	38001
TENSOR-MOTOR	38274
TENSOR-MOTOR	38329
MANGUERA SUPERIOR-DEPÓSITO A RAD.	19812



MASTER SERVICIO PESADO 2014

FORD

F-450 SUPER DUTY

BANDA-C/AA	K061000	MANGUERA SUPERIOR-DEPÓSITO A RAD.	19812
MANGUERA INFERIOR-	22432	TAPÓN DE GASOLINA-CON LLAVE	31828
MANGUERA SUPERIOR-	22431	MANGUERA DE CALEFACCIÓN-CALEFACCIÓN-TUBO1	19306
2002		BANDA-ALT-DH-VENT-AA	K081000
MANGUERA DE CALEFACCIÓN-TOMA DE MÚLTIPLE	19218	BANDA-ALT-DH-VENT	K080806
BANDA-S/AA	K060806	TERMOSTATO-195°	33469
POLEA-MOTOR	36157	TERMOSTATO-180°	33468
POLEA-MOTOR	38001	TAPÓN DE RADIADOR-(16 LBS) SIN PALANCA	31406
TENSOR-MOTOR	38274	MANGUERA INFERIOR-	22432
TENSOR-MOTOR	38329	MANGUERA SUPERIOR-	22431
MANGUERA SUPERIOR-DEPÓSITO A RAD.	19812	POLEA-	38022
BANDA-C/AA	K061000	POLEA DEL TENSOR-	38023
MANGUERA INFERIOR-	22432	TAPÓN DE ACEITE-	31109
MANGUERA SUPERIOR-	22431		
2001		F-550 SUPER DUTY	
MANGUERA DE CALEFACCIÓN-TOMA DE MÚLTIPLE	19218	FORD V8, 7.3 L DIESEL	
TENSOR-MOTOR	38133	2004	
TENSOR-MOTOR	38330	MANGUERA DE ENFRIAMIENTO-RAD. A DEPÓSITO	35B 3/8"
MANGUERA SUPERIOR-DEPÓSITO A RAD.	19812	MANGUERA DE CALEFACCIÓN-MOTOR	19200
MANGUERA DE CALEFACCIÓN-CALEFACCIÓN-TUBO1	19306	TENSOR-MOTOR	38191
BANDA-ALT-DH-VENT-AA	K081000	MANGUERA SUPERIOR-DEPÓSITO A RAD.	19812
BANDA-ALT-DH-VENT	K080806	BANDA-C/DOBLE ALT	K081377
MANGUERA INFERIOR-	22432	MANGUERA DE CALEFACCIÓN-BA	19201
MANGUERA SUPERIOR-	22431	BANDA-1 ALTERNADOR	K081223
POLEA-	38022	BANDA-	K081213
POLEA DEL TENSOR-	38023	MANGUERA INFERIOR-	22690
2000		MANGUERA SUPERIOR-	22433
MANGUERA DE CALEFACCIÓN-TOMA DE MÚLTIPLE	19218	MANGUERA SUPERIOR-	22542
TENSOR-MOTOR	38133	POLEA DEL TENSOR-	38028
TENSOR-MOTOR	38330	POLEA DEL TENSOR-	38053
MANGUERA SUPERIOR-DEPÓSITO A RAD.	19812	2003	
MANGUERA DE CALEFACCIÓN-CALEFACCIÓN-TUBO1	19306	MANGUERA DE ENFRIAMIENTO-RAD. A DEPÓSITO	35B 3/8"
BANDA-ALT-DH-VENT-AA	K081000	MANGUERA DE CALEFACCIÓN-MOTOR	19200
BANDA-ALT-DH-VENT	K080806	TENSOR-MOTOR	38191
MANGUERA INFERIOR-	22432	MANGUERA SUPERIOR-DEPÓSITO A RAD.	19812
MANGUERA SUPERIOR-	22431	BANDA-C/DOBLE ALT	K081377
POLEA-	38022	MANGUERA DE CALEFACCIÓN-BA	19201
POLEA DEL TENSOR-	38023	BANDA-1 ALTERNADOR	K081223
1999		BANDA-	K081213
MANGUERA DE CALEFACCIÓN-TOMA DE MÚLTIPLE	19218	MANGUERA INFERIOR-	22690
TAPÓN DE GASOLINA-SIN LLAVE	31830	MANGUERA SUPERIOR-	22433
TENSOR-MOTOR	38133	MANGUERA SUPERIOR-	22542
TENSOR-MOTOR	38330	POLEA DEL TENSOR-	38028



MASTER SERVICIO PESADO 2014

FORD

F-550 SUPER DUTY

POLEA DEL TENSOR-	38053	BANDA-ALT-DH-VENT-AA	K081223
2002		TERMOSTATO-195°	33909
MANGUERA DE ENFRIAMIENTO-RAD. A DEPÓSITO	35B 3/8"	MANGUERA INFERIOR-	22434
MANGUERA DE CALEFACCIÓN-MOTOR	19200	MANGUERA SUPERIOR-	22433
TENSOR-MOTOR	38191	MANGUERA SUPERIOR-	22542
MANGUERA SUPERIOR-DEPÓSITO A RAD.	19812	POLEA DEL TENSOR-	38028
BANDA-C/DOBLE ALT	K081377	POLEA DEL TENSOR-	38053
MANGUERA DE CALEFACCIÓN-BA	19201	FORD V8, 6.0 L DIESEL	
BANDA-1 ALTERNADOR	K081223	2007	
BANDA-	K081213	MANGUERA SUPERIOR-MOTOR A RAD.	22779
MANGUERA INFERIOR-	22690	BANDA-ALT-DH-VENT-AA-C/DOBLE ALT	K081325
MANGUERA SUPERIOR-	22433	BANDA-ALT-DH-VENT-AA-1ALT	K081265
MANGUERA SUPERIOR-	22542	TENSOR-ALT-DH-VENT-AA	38257
POLEA DEL TENSOR-	38028	BANDA-ALT-C/DOBLE ALT	K060658
POLEA DEL TENSOR-	38053	2006	
2001		MANGUERA INFERIOR-MOTOR A RAD.	22780
MANGUERA DE ENFRIAMIENTO-RAD. A DEPÓSITO	35B 3/8"	MANGUERA SUPERIOR-MOTOR A RAD.	22779
MANGUERA DE CALEFACCIÓN-MOTOR	19200	MANGUERA SUPERIOR-MOTOR A RAD.	22780
TENSOR-MOTOR	38191	BANDA-ALT-DH-VENT-AA-C/DOBLE ALT	K081325
MANGUERA SUPERIOR-DEPÓSITO A RAD.	19812	BANDA-ALT-DH-VENT-AA-1ALT	K081265
BANDA-C/DOBLE ALT	K081377	BANDA-ALT-DH-VENT-AA	K081265
MANGUERA DE CALEFACCIÓN-BA	19201	TENSOR-ALT-DH-VENT-AA	38257
BANDA-1 ALTERNADOR	K081223	BANDA-ALT-C/DOBLE ALT	K060658
MANGUERA INFERIOR-	22690	TAPÓN DE RADIADOR-(16 LBS) SIN PALANCA	31406
MANGUERA SUPERIOR-	22433	2005	
MANGUERA SUPERIOR-	22542	MANGUERA SUPERIOR-MOTOR A RAD.	22779
POLEA DEL TENSOR-	38028	MANGUERA INFERIOR-MOTOR A RAD	22780
POLEA DEL TENSOR-	38053	BANDA-ALT-DH-VENT-AA-C/DOBLE ALT	K081325
2000		BANDA-ALT-DH-VENT-AA-1ALT	K081265
MANGUERA DE ENFRIAMIENTO-RAD. A DEPÓSITO	35B 3/8"	TENSOR-ALT-DH-VENT-AA	38257
MANGUERA DE CALEFACCIÓN-MOTOR	19200	BANDA-ALT-C/DOBLE ALT	K060658
TENSOR-MOTOR	38191	2004	
MANGUERA SUPERIOR-DEPÓSITO A RAD.	19812	MANGUERA SUPERIOR-MOTOR A RAD.	22779
BANDA-C/DOBLE ALT	K081377	MANGUERA INFERIOR-MOTOR A RAD	22780
MANGUERA DE CALEFACCIÓN-BA	19201	BANDA-ALT-DH-VENT-AA-C/DOBLE ALT	K081325
BANDA-ALT-DH-VENT-AA	K081223	BANDA-ALT-DH-VENT-AA-1ALT	K081265
BANDA-1 ALTERNADOR	K081223	TENSOR-ALT-DH-VENT-AA	38257
MANGUERA INFERIOR-	22434	BANDA-ALT-C/DOBLE ALT	K060658
MANGUERA SUPERIOR-	22433	2003	
POLEA DEL TENSOR-	38028	MANGUERA SUPERIOR-MOTOR A RAD.	22779
POLEA DEL TENSOR-	38053	MANGUERA INFERIOR-MOTOR A RAD	22780
1999		BANDA-ALT-DH-VENT-AA-C/DOBLE ALT	K081325
TENSOR-MOTOR	38191	BANDA-ALT-DH-VENT-AA-1ALT	K081265



MASTER SERVICIO PESADO 2014

FORD

F-550 SUPER DUTY

TENSOR-ALT-DH-VENT-AA	38257	BANDA-S/AA	K060806
BANDA-ALT-C/DOBLE ALT	K060658	POLEA-MOTOR	36157
FORD V10, 6.8 L		POLEA-MOTOR	38001
2006		TENSOR-MOTOR	38274
BANDA-S/AA	K060806	TENSOR-MOTOR	38329
POLEA-MOTOR	36157	MANGUERA SUPERIOR-DEPÓSITO A RAD.	19812
POLEA-MOTOR	38001	BANDA-C/AA	K061000
TENSOR-MOTOR	38274	MANGUERA INFERIOR-	22432
TENSOR-MOTOR	38329	MANGUERA SUPERIOR-	22431
BANDA-C/AA	K060997	2002	
TAPÓN DE RADIADOR-(16 LBS) SIN PALANCA	31406	MANGUERA DE CALEFACCIÓN-TOMA DE MÚLTIPLE	19218
2005		BANDA-S/AA	K060806
BANDA-S/AA	K060806	POLEA-MOTOR	36157
POLEA-MOTOR	36157	POLEA-MOTOR	38001
POLEA-MOTOR	38001	TENSOR-MOTOR	38274
TENSOR-MOTOR	38274	TENSOR-MOTOR	38329
TENSOR-MOTOR	38329	MANGUERA SUPERIOR-DEPÓSITO A RAD.	19812
BANDA-C/AA	K061000	BANDA-C/AA	K061000
TAPÓN DE RADIADOR-(16 LBS) SIN PALANCA	31406	MANGUERA INFERIOR-	22432
MANGUERA INFERIOR-	22432	MANGUERA SUPERIOR-	22431
MANGUERA SUPERIOR-	22431	2001	
2004		MANGUERA DE CALEFACCIÓN-TOMA DE MÚLTIPLE	19218
MANGUERA DE CALEFACCIÓN-TOMA DE MÚLTIPLE	19218	TENSOR-MOTOR	38133
TAPÓN DE GASOLINA-SIN LLAVE C/CONT. DE EMISIÓN	31615	TENSOR-MOTOR	38330
TAPÓN DE GASOLINA-SIN LLAVE	31830	MANGUERA SUPERIOR-DEPÓSITO A RAD.	19812
BANDA-S/AA	K060806	MANGUERA DE CALEFACCIÓN-CALEFACCIÓN-TUBO1	19306
POLEA-MOTOR	36157	BANDA-ALT-DH-VENT-AA	K081000
POLEA-MOTOR	38001	BANDA-ALT-DH-VENT	K080806
TENSOR-MOTOR	38274	MANGUERA INFERIOR-	22432
TENSOR-MOTOR	38329	MANGUERA SUPERIOR-	22431
MANGUERA SUPERIOR-DEPÓSITO A RAD.	19812	POLEA-	38022
TAPÓN DE GASOLINA-CON LLAVE C/CONT. DE EMISIÓN	31734	POLEA DEL TENSOR-	38023
TAPÓN DE GASOLINA-CON LLAVE	31828	2000	
MANGUERA DE CALEFACCIÓN-CALEFACCIÓN-TUBO1	19306	MANGUERA DE CALEFACCIÓN-TOMA DE MÚLTIPLE	19218
BANDA-C/AA	K061000	TENSOR-MOTOR	38133
TERMOSTATO-195°	33469	TENSOR-MOTOR	38330
TERMOSTATO-180°	33468	MANGUERA SUPERIOR-DEPÓSITO A RAD.	19812
TAPÓN DE RADIADOR-(16 LBS) SIN PALANCA	31406	MANGUERA DE CALEFACCIÓN-CALEFACCIÓN-TUBO1	19306
MANGUERA INFERIOR-	22432	BANDA-ALT-DH-VENT-AA	K081000
MANGUERA SUPERIOR-	22431	BANDA-ALT-DH-VENT	K080806
TAPÓN DE ACEITE-	31109	MANGUERA INFERIOR-	22432
2003		MANGUERA SUPERIOR-	22431
MANGUERA DE CALEFACCIÓN-TOMA DE MÚLTIPLE	19218	POLEA-	38022



MASTER SERVICIO PESADO 2014

FORD

F-550 SUPER DUTY

POLEA DEL TENSOR-	38023	MANGUERA DE AGUA-	30T 5/8"
1999		MANGUERA DE PASO-	21942
MANGUERA DE CALEFACCIÓN-TOMA DE MÚLTIPLE	19218	MANGUERA INFERIOR-	21249
TAPÓN DE GASOLINA-SIN LLAVE	31830	MANGUERA SUPERIOR-	21936
TENSOR-MOTOR	38133	MANGUERA SUPERIOR-	21938
TENSOR-MOTOR	38330	TAPÓN DE ACEITE-	31109
MANGUERA SUPERIOR-DEPÓSITO A RAD.	19812	1993	
TAPÓN DE GASOLINA-CON LLAVE	31828	BANDA-VENT	9480
MANGUERA DE CALEFACCIÓN-CALEFACCIÓN-TUBO1	19306	MANGUERA INFERIOR-MOTOR A RAD	22400
BANDA-ALT-DH-VENT-AA	K081000	BANDA-INSTAL ARRIBA DEL VENT	9480
BANDA-ALT-DH-VENT	K080806	BANDA-DH-VENT	9530
TERMOSTATO-195°	33469	BANDA-COMPRESOR-C/FRENOS HID	9610
TERMOSTATO-180°	33468	BANDA-COMPRESOR-C/FRENOS DE AIRE	9650
TAPÓN DE RADIADOR-(16 LBS) SIN PALANCA	31406	BANDA-C/DH	9540
MANGUERA INFERIOR-	22432	BANDA-C/DH	9580
MANGUERA SUPERIOR-	22431	BANDA-C/AA, C/DH	9480
POLEA-	38022	BANDA-ALT-VENT-C/ALT 90A/130A, VENT FIJO	9463
POLEA DEL TENSOR-	38023	BANDA-ALT-VENT-C/ALT 90A/130A, VENT CLUTCH	9451
TAPÓN DE ACEITE-	31109	BANDA-ALT-VENT-C/ALT 75A, VENT FIJO	9463
		BANDA-ALT-VENT-C/ALT 75A, VENT CLUTCH	9447
		BANDA-ALT-VENT-C/ALT 60A, C/CABINA CUBIERTA, C/VENT CLUTCH	9440
		BANDA-ALT-VENT- C/ALT 60A, C/CABINA CUBIERTA, C/VENT CLUTCH	9435
		BANDA-ALT-VENT C/ALT 60A, C/CABINA CUBIERTA, C/VANT FIJO	9451
		BANDA-ALT-VENT C/ALT 60A, C/CABINA CUBIERTA	9447
		BANDA-AA	9360
		TAPÓN DE RADIADOR-(7 LBS) SIN PALANCA	31526
		TAPÓN DE RADIADOR-(7 LBS) CON PALANCA	31508
		MANGUERA DE AGUA-	30T 5/8"
		MANGUERA DE PASO-	21942
		MANGUERA INFERIOR-	21249
		MANGUERA SUPERIOR-	21936
		MANGUERA SUPERIOR-	21938
		1992	
		BANDA-VENT	9480
		MANGUERA INFERIOR-MOTOR A RAD	22400
		BANDA-INSTAL ARRIBA DEL VENT	9480
		BANDA-DH-VENT	9530
		BANDA-COMPRESOR-C/FRENOS HID	9610
		BANDA-COMPRESOR-C/FRENOS DE AIRE	9650
		BANDA-C/DH	9540
		BANDA-C/DH	9580
		BANDA-C/AA, C/DH	9480
		BANDA-ALT-VENT-C/ALT 90A/130A, VENT FIJO	9463
		BANDA-ALT-VENT-C/ALT 90A/130A, VENT CLUTCH	9451
		BANDA-ALT-VENT-C/ALT 75A, VENT FIJO	9463
		BANDA-ALT-VENT-C/ALT 75A, VENT CLUTCH	9447
		BANDA-ALT-VENT-C/ALT 60A, C/CABINA CUBIERTA, C/VENT CLUTCH	9440
		BANDA-ALT-VENT- C/ALT 60A, C/CABINA CUBIERTA, C/VENT CLUTCH	9435
		BANDA-ALT-VENT C/ALT 60A, C/CABINA CUBIERTA, C/VANT FIJO	9451
		BANDA-ALT-VENT C/ALT 60A, C/CABINA CUBIERTA	9447
		BANDA-AA	9360
		TAPÓN DE RADIADOR-(7 LBS) SIN PALANCA	31526
		TAPÓN DE RADIADOR-(7 LBS) CON PALANCA	31508
		BANDA-	9480

F-600

FORD V8, 7.0 L

1994

BANDA-VENT	9480		
MANGUERA INFERIOR-MOTOR A RAD	22400		
BANDA-DH-VENT	9530		
BANDA-COMPRESOR-C/FRENOS HID	9610		
BANDA-COMPRESOR-C/FRENOS DE AIRE	9650		
BANDA-C/DH	9540		
BANDA-C/DH	9580		
BANDA-C/AA, C/DH	9480		
BANDA-ALT-VENT-C/ALT 90A/130A, VENT FIJO	9463		
BANDA-ALT-VENT-C/ALT 90A/130A, VENT CLUTCH	9451		
BANDA-ALT-VENT-C/ALT 75A, VENT FIJO	9463		
BANDA-ALT-VENT-C/ALT 75A, VENT CLUTCH	9447		
BANDA-ALT-VENT-C/ALT 60A, C/CABINA CUBIERTA, C/VENT CLUTCH	9440		
BANDA-ALT-VENT- C/ALT 60A, C/CABINA CUBIERTA, C/VENT CLUTCH	9435		
BANDA-ALT-VENT C/ALT 60A, C/CABINA CUBIERTA, C/VANT FIJO	9451		
BANDA-ALT-VENT C/ALT 60A, C/CABINA CUBIERTA	9447		
BANDA-AA	9360		
TAPÓN DE RADIADOR-(7 LBS) SIN PALANCA	31526		
TAPÓN DE RADIADOR-(7 LBS) CON PALANCA	31508		
BANDA-	9480		



MASTER SERVICIO PESADO 2014

FORD

F-600

BANDA-ALT-VENT-C/ALT 90A/130A, VENT FIJO	9463	BANDA-VENT-INSTAL ARRIBA DEL VENT	9480
BANDA-ALT-VENT-C/ALT 90A/130A, VENT CLUTCH	9451	BANDA-COMPRESOR-C/FRENOS HID	9610
BANDA-ALT-VENT-C/ALT 75A, VENT FIJO	9463	BANDA-COMPRESOR-C/FRENOS DE AIRE	9650
BANDA-ALT-VENT-C/ALT 75A, VENT CLUTCH	9447	BANDA-C/DH	9540
BANDA-ALT-VENT-C/ALT 60A, C/CABINA CUBIERTA, C/VENT CLUTCH	9440	BANDA-C/DH	9580
BANDA-ALT-VENT- C/ALT 60A, C/CABINA CUBIERTA, C/VENT CLUTCH	9435	BANDA-ALT-C/ALT 90A/130A, VENT FIJO	9463
BANDA-ALT-VENT C/ALT 60A, C/CABINA CUBIERTA, C/VANT FIJO	9451	BANDA-ALT-C/ALT 90A/130A, VENT CLUTCH	9451
BANDA-ALT-VENT C/ALT 60A, C/CABINA CUBIERTA	9447	BANDA-ALT-C/ALT 75A, VENT FIJO	9463
BANDA-AA	9360	BANDA-ALT-C/ALT 75A, VENT CLUTCH	9447
TAPÓN DE RADIADOR-(7 LBS) SIN PALANCA	31526	BANDA-ALT-C/ALT 60A, C/CABINA CUBIERTA, C/VENT CLUTCH	9440
TAPÓN DE RADIADOR-(7 LBS) CON PALANCA	31508	BANDA-ALT-C/ALT 60A, C/CABINA CUBIERTA, C/VANT FIJO	9451
MANGUERA DE AGUA-	30T 5/8"	BANDA-ALT- C/ALT 60A, C/CABINA CUBIERTA, C/VENT CLUTCH	9435
MANGUERA DE PASO-	21942	BANDA-ALT C/ALT 60A, C/CABINA CUBIERTA	9447
MANGUERA INFERIOR-	21249	BANDA-AA	7660
MANGUERA SUPERIOR-	21936	BANDA-AA	9360
MANGUERA SUPERIOR-	21938	TERMOSTATO-180°	33046
1991		TERMOSTATO-180°	33308
BANDA-VENT	9480	TAPÓN DE RADIADOR-(7 LBS) SIN PALANCA	31526
BANDA-INSTAL ARRIBA DEL VENT	9480	TAPÓN DE RADIADOR-(7 LBS) CON PALANCA	31508
BANDA-DH-VENT	9530	MANGUERA DE AGUA-	30T 5/8"
BANDA-COMPRESOR-C/FRENOS HID	9610	MANGUERA DE PASO-	21942
BANDA-COMPRESOR-C/FRENOS DE AIRE	9650	MANGUERA INFERIOR-	21249
BANDA-C/DH	9540	MANGUERA SUPERIOR-	21936
BANDA-C/DH	9580	MANGUERA SUPERIOR-	21938
BANDA-C/AA, C/DH	9480		
BANDA-ALT-VENT-C/ALT 90A/130A, VENT FIJO	9463	FORD 6 CIL, 7.8 L DIESEL	
BANDA-ALT-VENT-C/ALT 90A/130A, VENT CLUTCH	9451	1993	
BANDA-ALT-VENT-C/ALT 75A, VENT FIJO	9463	BANDA-COMPRESOR	9630
BANDA-ALT-VENT-C/ALT 75A, VENT CLUTCH	9447	BANDA-ALT-INSTAL ARRIBA DEL VENT	9710
BANDA-ALT-VENT-C/ALT 60A, C/CABINA CUBIERTA, C/VENT CLUTCH	9440	BANDA-ALT	9710
BANDA-ALT-VENT- C/ALT 60A, C/CABINA CUBIERTA, C/VENT CLUTCH	9435	BANDA-AA	7597
BANDA-ALT-VENT C/ALT 60A, C/CABINA CUBIERTA, C/VANT FIJO	9451	BANDA-AA	9590
BANDA-ALT-VENT C/ALT 60A, C/CABINA CUBIERTA	9447	TERMOSTATO-180°	33188
BANDA-AA	9360	TAPÓN DE RADIADOR-(7 LBS) SIN PALANCA	31526
TAPÓN DE RADIADOR-(7 LBS) SIN PALANCA	31526	TAPÓN DE RADIADOR-(7 LBS) CON PALANCA	31508
TAPÓN DE RADIADOR-(7 LBS) CON PALANCA	31508	BANDA-	9650
MANGUERA DE AGUA-	30T 5/8"	MANGUERA INFERIOR-	21962
MANGUERA DE PASO-	21942	MANGUERA INFERIOR-	22033
MANGUERA INFERIOR-	21249	MANGUERA SUPERIOR-	21943
MANGUERA SUPERIOR-	21936		
MANGUERA SUPERIOR-	21938	1992	
		BANDA-COMPRESOR	9630
FORD V8, 6.1 L		BANDA-ALT	9710
1991		BANDA-AA	7597
		BANDA-AA	9590



MASTER SERVICIO PESADO 2014

FORD

F-600

TERMOSTATO-180°	33188	MANGUERA INFERIOR-	21962
TAPÓN DE RADIADOR-(7 LBS) SIN PALANCA	31526	MANGUERA SUPERIOR-	21943
TAPÓN DE RADIADOR-(7 LBS) CON PALANCA	31508	1992	
BANDA-	9650	MANGUERA SILICÓN-RAD. A ENFRIADOR	SIH250363C
MANGUERA INFERIOR-	21962	BANDA-DH-VENT	9545
MANGUERA INFERIOR-	22033	BANDA-COMPRESOR	9550
MANGUERA SUPERIOR-	21943	BANDA-COMPRESOR	9565
1991		BANDA-COMPRESOR	9630
MANGUERA SILICÓN-RAD. A ENFRIADOR	SIH250363C	BANDA-BA-DH-INSTAL ARRIBA DEL VENT	9630
BANDA-COMPRESOR	9630	BANDA-ALT-VENT-C/ALT 60A/75A/90A, INSTAL BAJO VENT	9610
BANDA-COMPRESOR	9650	BANDA-ALT-VENT C/ALT 60A/75A/90A INSTAL. ARRIBA VENT	9690
BANDA-ALT	9710	BANDA-ALT-VENT C/ALT 130A C/INSTAL. BAJO EL VENT	9625
BANDA-AA	7575	BANDA-ALT-VENT C/ALT 130A C/INSTAL. ARRIBA VENT	7570
BANDA-AA	9590	BANDA-AA	9590
TERMOSTATO-180°	33188	TERMOSTATO-180°	33188
TAPÓN DE RADIADOR-(7 LBS) SIN PALANCA	31526	TAPÓN DE RADIADOR-(7 LBS) SIN PALANCA	31526
TAPÓN DE RADIADOR-(7 LBS) CON PALANCA	31508	TAPÓN DE RADIADOR-(7 LBS) CON PALANCA	31508
BANDA-	9650	BANDA-	9650
MANGUERA DE ENFRIAMIENTO-	CHARTER 1 1/2"	MANGUERA DE ENFRIAMIENTO-	CHARTER 1 1/2"
MANGUERA INFERIOR-	21845	MANGUERA INFERIOR-	21845
MANGUERA INFERIOR-	21961	MANGUERA INFERIOR-	21961
MANGUERA INFERIOR-	21962	MANGUERA INFERIOR-	21962
MANGUERA SUPERIOR-	21943	MANGUERA SUPERIOR-	21943
FORD 6 CIL, 6.6 L DIESEL		1991	
1993		MANGUERA SILICÓN-RAD. A ENFRIADOR	SIH250363C
MANGUERA SILICÓN-RAD. A ENFRIADOR	SIH250363C	BANDA-DH-VENT	9545
BANDA-DH-VENT	9545	BANDA-COMPRESOR	9550
BANDA-COMPRESOR	9550	BANDA-COMPRESOR	9565
BANDA-COMPRESOR	9565	BANDA-COMPRESOR	9630
BANDA-COMPRESOR	9630	BANDA-COMPRESOR	9640
BANDA-BA-DH-INSTAL ARRIBA DEL VENT	9630	BANDA-BA-DH-INSTAL ARRIBA DEL VENT	9630
BANDA-ALT-VENT-C/ALT 60A/75A/90A, INSTAL BAJO VENT	9610	BANDA-ALT-VENT-C/ALT 60A/75A/90A, INSTAL BAJO VENT	9610
BANDA-ALT-VENT C/ALT 60A/75A/90A INSTAL. ARRIBA VENT	9690	BANDA-ALT-VENT C/ALT 60A/75A/90A INSTAL. ARRIBA VENT	9690
BANDA-ALT-VENT C/ALT 130A C/INSTAL. BAJO EL VENT	9625	BANDA-ALT-VENT C/ALT 130A C/INSTAL. BAJO EL VENT	9625
BANDA-ALT-VENT C/ALT 130A C/INSTAL. ARRIBA VENT	7570	BANDA-ALT-VENT C/ALT 130A C/INSTAL. ARRIBA VENT	7570
BANDA-AA	9590	BANDA-AA	7565
TERMOSTATO-180°	33188	BANDA-AA	9590
TAPÓN DE RADIADOR-(7 LBS) SIN PALANCA	31526	TERMOSTATO-180°	33188
TAPÓN DE RADIADOR-(7 LBS) CON PALANCA	31508	TAPÓN DE RADIADOR-(7 LBS) SIN PALANCA	31526
BANDA-	9650	TAPÓN DE RADIADOR-(7 LBS) CON PALANCA	31508
MANGUERA DE ENFRIAMIENTO-	CHARTER 1 1/2"	BANDA-	9650
MANGUERA INFERIOR-	21845	MANGUERA DE ENFRIAMIENTO-	CHARTER 1 1/2"
MANGUERA INFERIOR-	21961		



MASTER SERVICIO PESADO 2014

FORD

F-600

MANGUERA INFERIOR-	21845	BANDA-ALT-VENT	K080839
MANGUERA INFERIOR-	21961	POLEA-ALT-VENT	36095
MANGUERA INFERIOR-	21962	TENSOR-ALT-VENT	38517
MANGUERA SUPERIOR-	21943	TERMOSTATO-180°	33758
CUMMINS C Series 8.3 L DIESEL		TAPÓN DE RADIADOR-(7 LBS) SIN PALANCA	31526
1994		TAPÓN DE RADIADOR-(7 LBS) CON PALANCA	31508
MANGUERA SILICÓN-TUBO A RAD.	SIH200363C	BANDA-	9412
MANGUERA INFERIOR-MOTOR-TUBO	21901	MANGUERA DE AGUA-	30T 3/4"
MANGUERA SUPERIOR-MOTOR A TUBO	24436	MANGUERA SILICÓN-	SIH200363C
BANDA-ALT	K080720	1992	
BANDA-AA	9640	MANGUERA SILICÓN-TUBO A RAD.	SIH200363C
TERMOSTATO-180°-C/DOBLE TERMOSTATO	33966	MANGUERA SILICÓN-TUBO A ENFRIADOR	SIH200363C
TERMOSTATO-180°	33959	MANGUERA SUPERIOR-MOTOR A TUBO	CHARTER 1 3/4"
1993		BANDA-C/DH	9420
MANGUERA SILICÓN-TUBO A RAD.	SIH200363C	BANDA-ALT-VENT	K080830
MANGUERA INFERIOR-MOTOR-TUBO	21901	POLEA-ALT-VENT	36095
MANGUERA SUPERIOR-MOTOR A TUBO	24436	TENSOR-ALT-VENT	38517
BANDA-ALT-VENT	K080720	TERMOSTATO-180°	33758
BANDA-AA	9640	TAPÓN DE RADIADOR-(7 LBS) SIN PALANCA	31526
TERMOSTATO-180°-C/DOBLE TERMOSTATO	33966	TAPÓN DE RADIADOR-(7 LBS) CON PALANCA	31508
TERMOSTATO-180°	33959	BANDA-	9412
TAPÓN DE RADIADOR-(7 LBS) SIN PALANCA	31526	MANGUERA DE AGUA-	30T 3/4"
TAPÓN DE RADIADOR-(7 LBS) CON PALANCA	31508	MANGUERA SILICÓN-	SIH200363C
CUMMINS B Series 5.9 L DIESEL		F-650 SUPER DUTY	
1994		FORD V8, 7.3 L DIESEL	
MANGUERA SILICÓN-TUBO A RAD.	SIH200363C	2004	
MANGUERA SILICÓN-TUBO A ENFRIADOR	SIH200363C	MANGUERA SILICÓN-TUBO A RAD.	SIH200363C
MANGUERA SUPERIOR-MOTOR A TUBO	CHARTER 1 3/4"	MANGUERA INFERIOR-MOTOR-TUBO	20611
BANDA-C/DH	9420	MANGUERA SUPERIOR-MOTOR A TUBO	20611
BANDA-ALT-VENT	K080830	TENSOR-MOTOR	38191
BANDA-ALT-VENT	K080839	BANDA-ALT-BA-VENT-C/FRENOS HID	K080820
POLEA-ALT-VENT	36095	BANDA-ALT-BA-VENT-C/FRENOS DE AIRE	K081153
TENSOR-ALT-VENT	38517	BANDA-ALT-BA-VENT-AA-C/FRENOS HID	K080893
TERMOSTATO-180°	33888	BANDA-ALT-BA-VENT-AA-C/FRENOS DE AIRE	K081223
BANDA-	9412	POLEA DEL TENSOR-	38028
MANGUERA DE AGUA-	30T 3/4"	POLEA DEL TENSOR-	38053
MANGUERA SILICÓN-	SIH200363C	TAPÓN DE ACEITE-	31109
1993		2003	
MANGUERA SILICÓN-TUBO A RAD.	SIH200363C	MANGUERA SILICÓN-TUBO A RAD.	SIH200363C
MANGUERA SILICÓN-TUBO A ENFRIADOR	SIH200363C	MANGUERA INFERIOR-MOTOR-TUBO	20611
MANGUERA SUPERIOR-MOTOR A TUBO	CHARTER 1 3/4"	MANGUERA SUPERIOR-MOTOR A TUBO	20611
BANDA-C/DH	9420	TENSOR-MOTOR	38191
BANDA-ALT-VENT	K080830		



BANDA-ALT-BA-VENT-C/FRENOS HID	K080820	FORD V8, 6.0 L DIESEL	
BANDA-ALT-BA-VENT-C/FRENOS DE AIRE	K081153	2006	
BANDA-ALT-BA-VENT-AA-C/FRENOS HID	K080893	BANDA-VENT-COMPRESOR	K060509
BANDA-ALT-BA-VENT-AA-C/FRENOS DE AIRE	K081223	MANGUERA INFERIOR-MOTOR A RAD.	22775
POLEA DEL TENSOR-	38028	MANGUERA SUPERIOR-MOTOR A RAD.	22774
POLEA DEL TENSOR-	38053	MANGUERA SUPERIOR-MOTOR A RAD.	22775
TAPÓN DE ACEITE-	31109	BANDA-ALT-VENT-AA	K080830
2002		TENSOR-ALT-VENT-AA	38556
MANGUERA SILICÓN-TUBO A RAD.	SIH200363C	2005	
MANGUERA INFERIOR-MOTOR-TUBO	20611	MANGUERA SUPERIOR-MOTOR A RAD.	22774
MANGUERA SUPERIOR-MOTOR A TUBO	20611	MANGUERA INFERIOR-MOTOR A RAD	22775
TENSOR-MOTOR	38191	BANDA-ALT-VENT-AA	K080830
BANDA-ALT-BA-VENT-C/FRENOS HID	K080820	TENSOR-ALT-VENT-AA	38556
BANDA-ALT-BA-VENT-C/FRENOS DE AIRE	K081153	2004	
BANDA-ALT-BA-VENT-AA-C/FRENOS HID	K080893	MANGUERA SUPERIOR-MOTOR A RAD.	22774
BANDA-ALT-BA-VENT-AA-C/FRENOS DE AIRE	K081223	MANGUERA INFERIOR-MOTOR A RAD	22775
POLEA DEL TENSOR-	38028	BANDA-ALT-VENT-AA	K080830
POLEA DEL TENSOR-	38053	TENSOR-ALT-VENT-AA	38556
TAPÓN DE ACEITE-	31109	2003	
2001		MANGUERA SUPERIOR-MOTOR A RAD.	22774
MANGUERA SILICÓN-TUBO A RAD.	SIH200363C	MANGUERA INFERIOR-MOTOR A RAD	22775
MANGUERA INFERIOR-MOTOR-TUBO	20611	BANDA-ALT-VENT-AA	K080830
MANGUERA SUPERIOR-MOTOR A TUBO	20611	TENSOR-ALT-VENT-AA	38556
TENSOR-MOTOR	38191	CUMMINS ISB-07 DIESEL	
BANDA-ALT-BA-VENT-C/FRENOS HID	K080820	2009	
BANDA-ALT-BA-VENT-C/FRENOS DE AIRE	K081153	BANDA-ALT-BA-VENT-AA	K080834
BANDA-ALT-BA-VENT-AA-C/FRENOS HID	K080893	TENSOR-ALT-BA-AA	38631
BANDA-ALT-BA-VENT-AA-C/FRENOS DE AIRE	K081223	TERMOSTATO-190°	33915
POLEA DEL TENSOR-	38028	TERMOSTATO-180°	33956
POLEA DEL TENSOR-	38053	2008	
TAPÓN DE ACEITE-	31109	BANDA-ALT-BA-VENT-AA	K080834
2000		TENSOR-ALT-BA-AA	38631
MANGUERA SILICÓN-TUBO A RAD.	SIH200363C	TERMOSTATO-190°	33915
MANGUERA INFERIOR-MOTOR-TUBO	20611	TERMOSTATO-180°	33956
MANGUERA SUPERIOR-MOTOR A TUBO	20611	CUMMINS ISB DIESEL	
TENSOR-MOTOR	38191	2007	
BANDA-ALT-BA-VENT-C/FRENOS HID	K080820	MANGUERA SUPERIOR-RAD-TUBO	24436
BANDA-ALT-BA-VENT-C/FRENOS DE AIRE	K081153	MANGUERA SUPERIOR-MOTOR A TUBO	20206
BANDA-ALT-BA-VENT-AA-C/FRENOS HID	K080893	BANDA-ALT-BA-VENT-AA	K080797
BANDA-ALT-BA-VENT-AA-C/FRENOS DE AIRE	K081223	TENSOR-ALT-BA-AA	38517
POLEA DEL TENSOR-	38028	TERMOSTATO-190°	33915
POLEA DEL TENSOR-	38053	TERMOSTATO-180°	33956
TAPÓN DE ACEITE-	31109	2006	
		MANGUERA INFERIOR-RAD-TUBO	20611



MASTER SERVICIO PESADO 2014

FORD

F-650 SUPER DUTY

MANGUERA SUPERIOR-RAD-TUBO	24436	POLEA DEL TENSOR-VENT-AA	36093
MANGUERA SUPERIOR-MOTOR A TUBO	20206	TENSOR-VENT-AA	38516
BANDA-ALT-BA-VENT-AA	K080797	MANGUERA SILICÓN-TUBO A RAD.	SIH200363C
TENSOR-ALT-BA-AA	38517	MANGUERA SILICÓN-MOTOR A TUBO	SIH200363C
TERMOSTATO-190°	33915	BANDA-ALT-BA-VENT	K080726
TERMOSTATO-180°	33956	TERMOSTATO-190°	33915
2005		TERMOSTATO-180°	33956
MANGUERA SUPERIOR-RAD-TUBO	24436	2000	
MANGUERA SUPERIOR-MOTOR A TUBO	20206	BANDA-VENT-AA	9375
BANDA-ALT-BA-VENT-AA	K080797	MANGUERA SILICÓN-TUBO A RAD.	SIH200363C
TENSOR-ALT-BA-AA	38517	BANDA-TOMA DE FUERZA-ALT-VENT	K080726
TERMOSTATO-190°	33915	POLEA DEL TENSOR-TOMA DE FUERZA-ALT-VENT	36093
TERMOSTATO-180°	33956	TENSOR-TOMA DE FUERZA-ALT-VENT	38516
MANGUERA INFERIOR-	20611	MANGUERA SILICÓN-MOTOR A TUBO	SIH200363C
2004		TERMOSTATO-190°	33915
BANDA-VENT-AA	9375	TERMOSTATO-180°	33956
MANGUERA SILICÓN-TUBO A RAD.	SIH200363C	CATERPILLAR C7 DIESEL	
MANGUERA SILICÓN-MOTOR A TUBO	SIH200363C	2009	
BANDA-ALT-BA-VENT	K080726	TERMOSTATO-190°	33969
POLEA DEL TENSOR-ALT-BA-VENT	36093	TERMOSTATO-180°	33968
TENSOR-ALT-BA-VENT	38516	2008	
TERMOSTATO-190°	33915	TERMOSTATO-190°	33969
TERMOSTATO-180°	33956	TERMOSTATO-180°	33968
2003		2007	
BANDA-VENT-AA	9375	TERMOSTATO-190°	33969
MANGUERA SILICÓN-TUBO A RAD.	SIH200363C	TERMOSTATO-180°	33968
MANGUERA SILICÓN-MOTOR A TUBO	SIH200363C	2006	
BANDA-ALT-BA-VENT	K080726	MANGUERA SILICÓN-TUBO A RAD.	SIH200363C
POLEA DEL TENSOR-ALT-BA-VENT	36093	MANGUERA SUPERIOR-TUBO A MOTOR	21571
TENSOR-ALT-BA-VENT	38516	BANDA-ALT-VENT-AA	K080774
TERMOSTATO-190°	33915	TENSOR-ALT-VENT-AA	38550
TERMOSTATO-180°	33956	TERMOSTATO-190°	33969
2002		TERMOSTATO-180°	33968
BANDA-VENT-AA	9375	2005	
MANGUERA SILICÓN-TUBO A RAD.	SIH200363C	MANGUERA SILICÓN-TUBO A RAD.	SIH200363C
MANGUERA SILICÓN-MOTOR A TUBO	SIH200363C	MANGUERA SUPERIOR-TUBO A MOTOR	21571
BANDA-ALT-BA-VENT	K080726	BANDA-ALT-VENT-AA	K080774
POLEA DEL TENSOR-ALT-BA-VENT	36093	TENSOR-ALT-VENT-AA	38550
TENSOR-ALT-BA-VENT	38516	TERMOSTATO-190°	33969
TERMOSTATO-190°	33915	TERMOSTATO-180°	33968
TERMOSTATO-180°	33956	2004	
2001		MANGUERA SILICÓN-TUBO A RAD.	SIH200363C
BANDA-VENT-AA	9375	MANGUERA SUPERIOR-TUBO A MOTOR	21571



MASTER SERVICIO PESADO 2014

FORD

F-650 SUPER DUTY

BANDA-ALT-VENT-AA	K080774	MANGUERA SILICÓN-MOTOR A TUBO	SIH200363C
TENSOR-ALT-VENT-AA	38550	MANGUERA SUPERIOR-MOTOR A TUBO	20611
TERMOSTATO-190°	33969	BANDA-ALT-VENT-AA	K080816
TERMOSTATO-180°	33968	TENSOR-ALT-VENT-AA	38506
CATERPILLAR 3126 DIESEL		POLEA DEL TENSOR-ALT-BA-VENT	36091
2004		TERMOSTATO-190°	33969
MANGUERA SILICÓN-TUBO A RAD.	SIH200363C	TERMOSTATO-180°	33968
MANGUERA INFERIOR-MOTOR-TUBO	20611	F-750 SUPER DUTY	
MANGUERA SUPERIOR-MOTOR A TUBO	20611	FORD V8, 7.3 L DIESEL	
BANDA-ALT-VENT-AA	K080816	2004	
TENSOR-ALT-VENT-AA	38506	MANGUERA SILICÓN-TUBO A RAD.	SIH200363C
POLEA DEL TENSOR-ALT-BA-VENT	36091	MANGUERA INFERIOR-MOTOR-TUBO	20611
TERMOSTATO-190°	33969	MANGUERA SUPERIOR-MOTOR A TUBO	20611
TERMOSTATO-180°	33968	TENSOR-MOTOR	38191
2003		BANDA-ALT-BA-VENT-C/FRENOS HID	K080820
MANGUERA SILICÓN-TUBO A RAD.	SIH200363C	BANDA-ALT-BA-VENT-C/FRENOS DE AIRE	K081153
MANGUERA INFERIOR-MOTOR-TUBO	20611	BANDA-ALT-BA-VENT-AA-C/FRENOS HID	K080893
MANGUERA SUPERIOR-MOTOR A TUBO	20611	BANDA-ALT-BA-VENT-AA-C/FRENOS DE AIRE	K081223
BANDA-ALT-VENT-AA	K080816	POLEA DEL TENSOR-	38028
TENSOR-ALT-VENT-AA	38506	POLEA DEL TENSOR-	38053
POLEA DEL TENSOR-ALT-BA-VENT	36091	TAPÓN DE ACEITE-	31109
TERMOSTATO-190°	33969	2003	
TERMOSTATO-180°	33968	MANGUERA SILICÓN-TUBO A RAD.	SIH200363C
2002		MANGUERA INFERIOR-MOTOR-TUBO	20611
MANGUERA SILICÓN-TUBO A RAD.	SIH200363C	MANGUERA SUPERIOR-MOTOR A TUBO	20611
MANGUERA INFERIOR-MOTOR-TUBO	20611	TENSOR-MOTOR	38191
MANGUERA SUPERIOR-MOTOR A TUBO	20611	BANDA-ALT-BA-VENT-C/FRENOS HID	K080820
BANDA-ALT-VENT-AA	K080816	BANDA-ALT-BA-VENT-C/FRENOS DE AIRE	K081153
TENSOR-ALT-VENT-AA	38506	BANDA-ALT-BA-VENT-AA-C/FRENOS HID	K080893
POLEA DEL TENSOR-ALT-BA-VENT	36091	BANDA-ALT-BA-VENT-AA-C/FRENOS DE AIRE	K081223
TERMOSTATO-190°	33969	POLEA DEL TENSOR-	38028
TERMOSTATO-180°	33968	POLEA DEL TENSOR-	38053
2001		TAPÓN DE ACEITE-	31109
MANGUERA SILICÓN-TUBO A RAD.	SIH200363C	2002	
MANGUERA SILICÓN-MOTOR A TUBO	SIH200363C	MANGUERA SILICÓN-TUBO A RAD.	SIH200363C
MANGUERA SUPERIOR-MOTOR A TUBO	20611	MANGUERA INFERIOR-MOTOR-TUBO	20611
BANDA-ALT-VENT-AA	K080816	MANGUERA SUPERIOR-MOTOR A TUBO	20611
TENSOR-ALT-VENT-AA	38506	TENSOR-MOTOR	38191
POLEA DEL TENSOR-ALT-BA-VENT	36091	BANDA-ALT-BA-VENT-C/FRENOS HID	K080820
TERMOSTATO-190°	33969	BANDA-ALT-BA-VENT-C/FRENOS DE AIRE	K081153
TERMOSTATO-180°	33968	BANDA-ALT-BA-VENT-AA-C/FRENOS HID	K080893
2000		BANDA-ALT-BA-VENT-AA-C/FRENOS DE AIRE	K081223
MANGUERA SILICÓN-TUBO A RAD.	SIH200363C		



MASTER SERVICIO PESADO 2014

FORD

F-750 SUPER DUTY

POLEA DEL TENSOR-	38028	BANDA-ALT-VENT-AA	K080830
POLEA DEL TENSOR-	38053	TENSOR-ALT-VENT-AA	38556
TAPÓN DE ACEITE-	31109	2003	
2001		MANGUERA SUPERIOR-MOTOR A RAD.	22774
MANGUERA SILICÓN-TUBO A RAD.	SIH200363C	MANGUERA INFERIOR-MOTOR A RAD	22775
MANGUERA INFERIOR-MOTOR-TUBO	20611	BANDA-ALT-VENT-AA	K080830
MANGUERA SUPERIOR-MOTOR A TUBO	20611	TENSOR-ALT-VENT-AA	38556
TENSOR-MOTOR	38191	CUMMINS ISB-07 DIESEL	
BANDA-ALT-BA-VENT-C/FRENOS HID	K080820	2009	
BANDA-ALT-BA-VENT-C/FRENOS DE AIRE	K081153	BANDA-MOTOR	K080834
BANDA-ALT-BA-VENT-AA-C/FRENOS HID	K080893	TENSOR-ALT-BA-VENT-AA	38631
BANDA-ALT-BA-VENT-AA-C/FRENOS DE AIRE	K081223	2008	
POLEA DEL TENSOR-	38028	BANDA-MOTOR	K080834
POLEA DEL TENSOR-	38053	TENSOR-ALT-BA-VENT-AA	38631
TAPÓN DE ACEITE-	31109	TERMOSTATO-190°	33915
		TERMOSTATO-180°	33956
2000		CUMMINS ISB DIESEL	
MANGUERA SILICÓN-TUBO A RAD.	SIH200363C	2007	
MANGUERA INFERIOR-MOTOR-TUBO	20611	MANGUERA SUPERIOR-RAD-TUBO	24436
MANGUERA SUPERIOR-MOTOR A TUBO	20611	MANGUERA SUPERIOR-MOTOR A TUBO	20206
TENSOR-MOTOR	38191	BANDA-ALT-BA-VENT-AA	K080797
BANDA-ALT-BA-VENT-C/FRENOS HID	K080820	TENSOR-ALT-BA-AA	38517
BANDA-ALT-BA-VENT-C/FRENOS DE AIRE	K081153	TERMOSTATO-190°	33915
BANDA-ALT-BA-VENT-AA-C/FRENOS HID	K080893	TERMOSTATO-180°	33956
BANDA-ALT-BA-VENT-AA-C/FRENOS DE AIRE	K081223	2006	
POLEA DEL TENSOR-	38028	MANGUERA INFERIOR-RAD-TUBO	20611
POLEA DEL TENSOR-	38053	MANGUERA SUPERIOR-RAD-TUBO	24436
TAPÓN DE ACEITE-	31109	MANGUERA SUPERIOR-MOTOR A TUBO	20206
FORD V8, 6.0 L DIESEL		BANDA-ALT-BA-VENT-AA	K080797
2006		TENSOR-ALT-BA-AA	38517
BANDA-VENT-COMPRESOR	K060509	TERMOSTATO-190°	33915
MANGUERA INFERIOR-MOTOR A RAD.	22775	TERMOSTATO-180°	33956
MANGUERA SUPERIOR-MOTOR A RAD.	22774	2005	
MANGUERA SUPERIOR-MOTOR A RAD.	22775	MANGUERA INFERIOR-RAD-TUBO	20611
BANDA-ALT-VENT-AA	K080830	MANGUERA SUPERIOR-RAD-TUBO	24436
TENSOR-ALT-VENT-AA	38556	MANGUERA SUPERIOR-MOTOR A TUBO	20206
2005		BANDA-ALT-BA-VENT-AA	K080797
MANGUERA SUPERIOR-MOTOR A RAD.	22774	TENSOR-ALT-BA-AA	38517
MANGUERA INFERIOR-MOTOR A RAD	22775	TERMOSTATO-190°	33915
BANDA-ALT-VENT-AA	K080830	TERMOSTATO-180°	33956
TENSOR-ALT-VENT-AA	38556	2004	
2004		BANDA-VENT-AA	9375
MANGUERA SUPERIOR-MOTOR A RAD.	22774	MANGUERA SILICÓN-TUBO A RAD.	SIH200363C
MANGUERA INFERIOR-MOTOR A RAD	22775		



MASTER SERVICIO PESADO 2014

FORD

F-750 SUPER DUTY

MANGUERA SILICÓN-MOTOR A TUBO	SIH200363C	2008	
BANDA-ALT-BA-VENT	K080726	TERMOSTATO-190°	33969
POLEA DEL TENSOR-ALT-BA-VENT	36093	TERMOSTATO-180°	33968
TENSOR-ALT-BA-VENT	38516	2007	
TERMOSTATO-190°	33915	TERMOSTATO-190°	33969
TERMOSTATO-180°	33956	TERMOSTATO-180°	33968
2003		2006	
BANDA-VENT-AA	9375	MANGUERA SILICÓN-TUBO A RAD.	SIH200363C
MANGUERA SILICÓN-TUBO A RAD.	SIH200363C	MANGUERA SUPERIOR-TUBO A MOTOR	21571
MANGUERA SILICÓN-MOTOR A TUBO	SIH200363C	BANDA-ALT-VENT-AA	K080774
BANDA-ALT-BA-VENT	K080726	TENSOR-ALT-VENT-AA	38550
POLEA DEL TENSOR-ALT-BA-VENT	36093	TERMOSTATO-190°	33969
TENSOR-ALT-BA-VENT	38516	TERMOSTATO-180°	33968
TERMOSTATO-190°	33915	2005	
TERMOSTATO-180°	33956	MANGUERA SILICÓN-TUBO A RAD.	SIH200363C
2002		MANGUERA SUPERIOR-TUBO A MOTOR	21571
BANDA-VENT-AA	9375	BANDA-ALT-VENT-AA	K080774
MANGUERA SILICÓN-TUBO A RAD.	SIH200363C	TENSOR-ALT-VENT-AA	38550
MANGUERA SILICÓN-MOTOR A TUBO	SIH200363C	TERMOSTATO-190°	33969
BANDA-ALT-BA-VENT	K080726	TERMOSTATO-180°	33968
POLEA DEL TENSOR-ALT-BA-VENT	36093	2004	
TENSOR-ALT-BA-VENT	38516	MANGUERA SILICÓN-TUBO A RAD.	SIH200363C
TERMOSTATO-190°	33915	MANGUERA SUPERIOR-TUBO A MOTOR	21571
TERMOSTATO-180°	33956	BANDA-ALT-VENT-AA	K080774
2001		TENSOR-ALT-VENT-AA	38550
BANDA-VENT-AA	9375	TERMOSTATO-190°	33969
POLEA DEL TENSOR-VENT-AA	36093	TERMOSTATO-180°	33968
TENSOR-VENT-AA	38516	CATERPILLAR 3126 DIESEL	
MANGUERA SILICÓN-TUBO A RAD.	SIH200363C	2004	
MANGUERA SILICÓN-MOTOR A TUBO	SIH200363C	MANGUERA SILICÓN-TUBO A RAD.	SIH200363C
BANDA-ALT-BA-VENT	K080726	MANGUERA INFERIOR-MOTOR-TUBO	20611
TERMOSTATO-190°	33915	MANGUERA SUPERIOR-MOTOR A TUBO	20611
TERMOSTATO-180°	33956	BANDA-ALT-VENT-AA	K080816
2000		TENSOR-ALT-VENT-AA	38506
BANDA-VENT-AA	9375	POLEA DEL TENSOR-ALT-BA-VENT	36091
MANGUERA SILICÓN-TUBO A RAD.	SIH200363C	TERMOSTATO-190°	33969
BANDA-TOMA DE FUERZA-ALT-VENT	K080726	TERMOSTATO-180°	33968
POLEA DEL TENSOR-TOMA DE FUERZA-ALT-VENT	36093	2003	
TENSOR-TOMA DE FUERZA-ALT-VENT	38516	MANGUERA SILICÓN-TUBO A RAD.	SIH200363C
MANGUERA SILICÓN-MOTOR A TUBO	SIH200363C	MANGUERA INFERIOR-MOTOR-TUBO	20611
TERMOSTATO-190°	33915	MANGUERA SUPERIOR-MOTOR A TUBO	20611
TERMOSTATO-180°	33956	BANDA-ALT-VENT-AA	K080816
CATERPILLAR C7 DIESEL		TENSOR-ALT-VENT-AA	38506



MASTER SERVICIO PESADO 2014

FORD

F-750 SUPER DUTY

POLEA DEL TENSOR-ALT-BA-VENT	36091
TERMOSTATO-190°	33969
TERMOSTATO-180°	33968
2002	
MANGUERA SILICÓN-TUBO A RAD.	SIH200363C
MANGUERA INFERIOR-MOTOR-TUBO	20611
MANGUERA SUPERIOR-MOTOR A TUBO	20611
BANDA-ALT-VENT-AA	K080816
TENSOR-ALT-VENT-AA	38506
POLEA DEL TENSOR-ALT-BA-VENT	36091
TERMOSTATO-190°	33969
TERMOSTATO-180°	33968

2001	
MANGUERA SILICÓN-TUBO A RAD.	SIH200363C
MANGUERA SILICÓN-MOTOR A TUBO	SIH200363C
MANGUERA SUPERIOR-MOTOR A TUBO	20611
BANDA-ALT-VENT-AA	K080816
TENSOR-ALT-VENT-AA	38506
POLEA DEL TENSOR-ALT-BA-VENT	36091
TERMOSTATO-190°	33969
TERMOSTATO-180°	33968

2000	
MANGUERA SILICÓN-TUBO A RAD.	SIH200363C
MANGUERA SILICÓN-MOTOR A TUBO	SIH200363C
MANGUERA SUPERIOR-MOTOR A TUBO	20611
BANDA-ALT-VENT-AA	K080816
TENSOR-ALT-VENT-AA	38506
POLEA DEL TENSOR-ALT-BA-VENT	36091
TERMOSTATO-190°	33969
TERMOSTATO-180°	33968

F-800

CUMMINS ISB DIESEL

1999	
MANGUERA INFERIOR-TUBO A RAD.	24432
MANGUERA SUPERIOR-TUBO A RAD.	24432
MANGUERA INFERIOR-MOTOR A TUBO	24432
MANGUERA SUPERIOR-MOTOR A TUBO	24432
BANDA-ALT-BA-VENT	K080830
BANDA-AA	8416 GS
TERMOSTATO-190°	33915
TERMOSTATO-180°	33956
1998	
MANGUERA INFERIOR-TUBO A RAD.	24432

MANGUERA SUPERIOR-TUBO A RAD.	24432
BANDA-TOMA DE FUERZA-ALT-VENT-AA	K080830
TENSOR-TOMA DE FUERZA-ALT-VENT-AA	38517
MANGUERA INFERIOR-MOTOR A TUBO	24432
MANGUERA SUPERIOR-MOTOR A TUBO	24432
BANDA-DH-VENT	PQ17420
TERMOSTATO-190°	33915
TERMOSTATO-180°	33956

FREIGHTLINER



ARGOSY

DETROIT DIESEL 6 CIL, 14.0 L DIESEL

2008	
BANDA-VENT	K100579
POLEA DEL TENSOR-VENT	38076
TENSOR-VENT	38503
MANGUERA INFERIOR-RAD. A TUBO	21891
MANGUERA SILICÓN-RAD. A TUBO	SIH250363C
MANGUERA SILICÓN-MOTOR A TUBO	SIH250363C
MANGUERA SILICÓN-MOTOR A ENFRIADOR	SIH275363C
MANGUERA SILICÓN-ENFRIADOR A TUBO	SIH275363C
BANDA-ALT-AA	K080580
POLEA DEL TENSOR-ALT-AA	38075
TENSOR-ALT-AA	38501
TERMOSTATO-190°	33599
BOMBA DE AGUA-	44066HD
2007	
BANDA-VENT	K100579
POLEA DEL TENSOR-VENT	38076
TENSOR-VENT	38503
MANGUERA INFERIOR-RAD. A TUBO	21891
MANGUERA SILICÓN-RAD. A TUBO	SIH250363C
MANGUERA SILICÓN-MOTOR A TUBO	SIH250363C
MANGUERA SILICÓN-MOTOR A ENFRIADOR	SIH275363C
MANGUERA SILICÓN-ENFRIADOR A TUBO	SIH275363C
BANDA-ALT-AA	K080580
POLEA DEL TENSOR-ALT-AA	38075
TENSOR-ALT-AA	38501
TERMOSTATO-190°	33599
BOMBA DE AGUA-	44066HD
2006	



MASTER SERVICIO PESADO 2014

FREIGHTLINER

ARGOSY

BANDA-VENT	K100579	POLEA DEL TENSOR-VENT	38076
POLEA DEL TENSOR-VENT	38076	TENSOR-VENT	38503
TENSOR-VENT	38503	MANGUERA INFERIOR-RAD. A TUBO	21891
MANGUERA INFERIOR-RAD. A TUBO	21891	MANGUERA SILICÓN-RAD. A TUBO	SIH250363C
MANGUERA SILICÓN-RAD. A TUBO	SIH250363C	MANGUERA SILICÓN-MOTOR A TUBO	SIH250363C
MANGUERA SILICÓN-MOTOR A TUBO	SIH250363C	MANGUERA SILICÓN-MOTOR A ENFRIADOR	SIH275363C
MANGUERA SILICÓN-MOTOR A ENFRIADOR	SIH275363C	MANGUERA SILICÓN-ENFRIADOR A TUBO	SIH275363C
MANGUERA SILICÓN-ENFRIADOR A TUBO	SIH275363C	BANDA-ALT-AA	K080580
BANDA-ALT-AA	K080580	POLEA DEL TENSOR-ALT-AA	38075
POLEA DEL TENSOR-ALT-AA	38075	TENSOR-ALT-AA	38501
TENSOR-ALT-AA	38501	TERMOSTATO-190°	33599
TERMOSTATO-190°	33599	BOMBA DE AGUA-	44066HD
BOMBA DE AGUA-	44066HD	2002	
2005		BANDA-VENT	K100579
BANDA-VENT	K100579	POLEA DEL TENSOR-VENT	38076
POLEA DEL TENSOR-VENT	38076	TENSOR-VENT	38503
TENSOR-VENT	38503	MANGUERA INFERIOR-RAD. A TUBO	21891
MANGUERA INFERIOR-RAD. A TUBO	21891	MANGUERA SILICÓN-RAD. A TUBO	SIH250363C
MANGUERA SILICÓN-RAD. A TUBO	SIH250363C	MANGUERA SILICÓN-MOTOR A TUBO	SIH250363C
MANGUERA SILICÓN-MOTOR A TUBO	SIH250363C	MANGUERA SILICÓN-MOTOR A ENFRIADOR	SIH275363C
MANGUERA SILICÓN-MOTOR A ENFRIADOR	SIH275363C	MANGUERA SILICÓN-ENFRIADOR A TUBO	SIH275363C
MANGUERA SILICÓN-ENFRIADOR A TUBO	SIH275363C	BANDA-ALT-AA	K080580
BANDA-ALT-AA	K080580	POLEA DEL TENSOR-ALT-AA	38075
POLEA DEL TENSOR-ALT-AA	38075	TENSOR-ALT-AA	38501
TENSOR-ALT-AA	38501	TERMOSTATO-190°	33599
TERMOSTATO-190°	33599	BOMBA DE AGUA-	44066HD
BOMBA DE AGUA-	44066HD	2001	
2004		BANDA-VENT	K100579
BANDA-VENT	K100579	POLEA DEL TENSOR-VENT	38076
POLEA DEL TENSOR-VENT	38076	TENSOR-VENT	38503
TENSOR-VENT	38503	MANGUERA INFERIOR-RAD. A TUBO	21891
MANGUERA INFERIOR-RAD. A TUBO	21891	MANGUERA SILICÓN-RAD. A TUBO	SIH250363C
MANGUERA SILICÓN-RAD. A TUBO	SIH250363C	MANGUERA SILICÓN-MOTOR A TUBO	SIH250363C
MANGUERA SILICÓN-MOTOR A TUBO	SIH250363C	MANGUERA SILICÓN-MOTOR A ENFRIADOR	SIH275363C
MANGUERA SILICÓN-MOTOR A ENFRIADOR	SIH275363C	MANGUERA SILICÓN-ENFRIADOR A TUBO	SIH275363C
MANGUERA SILICÓN-ENFRIADOR A TUBO	SIH275363C	BANDA-ALT-AA	K080580
BANDA-ALT-AA	K080580	POLEA DEL TENSOR-ALT-AA	38075
POLEA DEL TENSOR-ALT-AA	38075	TENSOR-ALT-AA	38501
TENSOR-ALT-AA	38501	TERMOSTATO-190°	33599
TERMOSTATO-190°	33599	BOMBA DE AGUA-	44066HD
BOMBA DE AGUA-	44066HD	DETROIT DIESEL 6 CIL, 12.7 L DIESEL	
2003		2008	
BANDA-VENT	K100579	BANDA-VENT	K100579



MASTER SERVICIO PESADO 2014

FREIGHTLINER

ARGOSY

POLEA DEL TENSOR-VENT	38076	TENSOR-VENT	38503
TENSOR-VENT	38503	MANGUERA INFERIOR-RAD. A TUBO	21891
MANGUERA INFERIOR-RAD. A TUBO	21891	MANGUERA SILICÓN-RAD. A TUBO	SIH250363C
MANGUERA SILICÓN-RAD. A TUBO	SIH250363C	MANGUERA SILICÓN-MOTOR A TUBO	SIH250363C
MANGUERA SILICÓN-MOTOR A TUBO	SIH250363C	MANGUERA SILICÓN-MOTOR A ENFRIADOR	SIH275363C
MANGUERA SILICÓN-MOTOR A ENFRIADOR	SIH275363C	MANGUERA SILICÓN-ENFRIADOR A TUBO	SIH275363C
MANGUERA SILICÓN-ENFRIADOR A TUBO	SIH275363C	BANDA-ALT-AA	K080580
BANDA-ALT-AA	K080580	POLEA DEL TENSOR-ALT-AA	38075
POLEA DEL TENSOR-ALT-AA	38075	TENSOR-ALT-AA	38501
TENSOR-ALT-AA	38501	TERMOSTATO-190°	33599
TERMOSTATO-190°	33599	BOMBA DE AGUA-	44066HD
BOMBA DE AGUA-	44066HD	2004	
2007		BANDA-VENT	K100579
BANDA-VENT	K100579	POLEA DEL TENSOR-VENT	38076
POLEA DEL TENSOR-VENT	38076	TENSOR-VENT	38503
TENSOR-VENT	38503	MANGUERA INFERIOR-RAD. A TUBO	21891
MANGUERA INFERIOR-RAD. A TUBO	21891	MANGUERA SILICÓN-RAD. A TUBO	SIH250363C
MANGUERA SILICÓN-RAD. A TUBO	SIH250363C	MANGUERA SILICÓN-MOTOR A TUBO	SIH250363C
MANGUERA SILICÓN-MOTOR A TUBO	SIH250363C	MANGUERA SILICÓN-MOTOR A ENFRIADOR	SIH275363C
MANGUERA SILICÓN-MOTOR A ENFRIADOR	SIH275363C	MANGUERA SILICÓN-ENFRIADOR A TUBO	SIH275363C
MANGUERA SILICÓN-ENFRIADOR A TUBO	SIH275363C	BANDA-ALT-AA	K080580
BANDA-ALT-AA	K080580	POLEA DEL TENSOR-ALT-AA	38075
POLEA DEL TENSOR-ALT-AA	38075	TENSOR-ALT-AA	38501
TENSOR-ALT-AA	38501	TERMOSTATO-190°	33599
TERMOSTATO-190°	33599	BOMBA DE AGUA-	44066HD
BOMBA DE AGUA-	44066HD	2003	
2006		BANDA-VENT	K100579
BANDA-VENT	K100579	POLEA DEL TENSOR-VENT	38076
POLEA DEL TENSOR-VENT	38076	TENSOR-VENT	38503
TENSOR-VENT	38503	MANGUERA INFERIOR-RAD. A TUBO	21891
MANGUERA INFERIOR-RAD. A TUBO	21891	MANGUERA SILICÓN-RAD. A TUBO	SIH250363C
MANGUERA SILICÓN-RAD. A TUBO	SIH250363C	MANGUERA SILICÓN-MOTOR A TUBO	SIH250363C
MANGUERA SILICÓN-MOTOR A TUBO	SIH250363C	MANGUERA SILICÓN-MOTOR A ENFRIADOR	SIH275363C
MANGUERA SILICÓN-MOTOR A ENFRIADOR	SIH275363C	MANGUERA SILICÓN-ENFRIADOR A TUBO	SIH275363C
MANGUERA SILICÓN-ENFRIADOR A TUBO	SIH275363C	BANDA-ALT-AA	K080580
BANDA-ALT-AA	K080580	POLEA DEL TENSOR-ALT-AA	38075
POLEA DEL TENSOR-ALT-AA	38075	TENSOR-ALT-AA	38501
TENSOR-ALT-AA	38501	TERMOSTATO-190°	33599
TERMOSTATO-190°	33599	BOMBA DE AGUA-	44066HD
BOMBA DE AGUA-	44066HD	2002	
2005		BANDA-VENT	K100579
BANDA-VENT	K100579	POLEA DEL TENSOR-VENT	38076
POLEA DEL TENSOR-VENT	38076	TENSOR-VENT	38503



MASTER SERVICIO PESADO 2014

FREIGHTLINER

ARGOSY

MANGUERA INFERIOR-RAD. A TUBO	21891	MANGUERA SILICÓN-RAD. A TUBO	SIH250363C
MANGUERA SILICÓN-RAD. A TUBO	SIH250363C	MANGUERA SILICÓN-MOTOR A TUBO	SIH250363C
MANGUERA SILICÓN-MOTOR A TUBO	SIH250363C	MANGUERA SILICÓN-MOTOR A ENFRIADOR	SIH275363C
MANGUERA SILICÓN-MOTOR A ENFRIADOR	SIH275363C	MANGUERA SILICÓN-ENFRIADOR A TUBO	SIH275363C
MANGUERA SILICÓN-ENFRIADOR A TUBO	SIH275363C	BANDA-ALT-AA	9600
BANDA-ALT-AA	K080580	TERMOSTATO-190°	33599
POLEA DEL TENSOR-ALT-AA	38075	DETROIT DIESEL 6 CIL, 11.1 L DIESEL	
TENSOR-ALT-AA	38501	2003	
TERMOSTATO-190°	33599	BANDA-VENT	K100579
BOMBA DE AGUA-	44066HD	POLEA DEL TENSOR-VENT	38076
2001		TENSOR-VENT	38503
BANDA-VENT	K100579	MANGUERA INFERIOR-RAD. A TUBO	21891
POLEA DEL TENSOR-VENT	38076	MANGUERA SILICÓN-RAD. A TUBO	SIH250363C
TENSOR-VENT	38503	MANGUERA SILICÓN-MOTOR A TUBO	SIH250363C
MANGUERA INFERIOR-RAD. A TUBO	21891	MANGUERA SILICÓN-MOTOR A ENFRIADOR	SIH275363C
MANGUERA SILICÓN-RAD. A TUBO	SIH250363C	MANGUERA SILICÓN-ENFRIADOR A TUBO	SIH275363C
MANGUERA SILICÓN-MOTOR A TUBO	SIH250363C	BANDA-ALT-AA	K080580
MANGUERA SILICÓN-MOTOR A ENFRIADOR	SIH275363C	POLEA DEL TENSOR-ALT-AA	38075
MANGUERA SILICÓN-ENFRIADOR A TUBO	SIH275363C	TENSOR-ALT-AA	38501
BANDA-ALT-AA	K080580	TERMOSTATO-190°	33599
POLEA DEL TENSOR-ALT-AA	38075	2002	
TENSOR-ALT-AA	38501	BANDA-VENT	K100579
TERMOSTATO-190°	33599	POLEA DEL TENSOR-VENT	38076
BOMBA DE AGUA-	44066HD	TENSOR-VENT	38503
2000		MANGUERA INFERIOR-RAD. A TUBO	21891
BANDA-VENT	K100579	MANGUERA SILICÓN-RAD. A TUBO	SIH250363C
POLEA DEL TENSOR-VENT	38076	MANGUERA SILICÓN-MOTOR A TUBO	SIH250363C
TENSOR-VENT	38503	MANGUERA SILICÓN-MOTOR A ENFRIADOR	SIH275363C
MANGUERA INFERIOR-RAD. A TUBO	21891	MANGUERA SILICÓN-ENFRIADOR A TUBO	SIH275363C
MANGUERA SILICÓN-RAD. A TUBO	SIH250363C	BANDA-ALT-AA	K080580
MANGUERA SILICÓN-MOTOR A TUBO	SIH250363C	POLEA DEL TENSOR-ALT-AA	38075
MANGUERA SILICÓN-MOTOR A ENFRIADOR	SIH275363C	TENSOR-ALT-AA	38501
MANGUERA SILICÓN-ENFRIADOR A TUBO	SIH275363C	TERMOSTATO-190°	33599
BANDA-ALT-AA	K080580	2001	
POLEA DEL TENSOR-ALT-AA	38075	BANDA-VENT	K100579
TENSOR-ALT-AA	38501	POLEA DEL TENSOR-VENT	38076
TERMOSTATO-190°	33599	TENSOR-VENT	38503
1999		MANGUERA INFERIOR-RAD. A TUBO	21891
BANDA-VENT	9590	MANGUERA SILICÓN-RAD. A TUBO	SIH250363C
BANDA-TOMA DE FUERZA-ALT-AA	K080585	MANGUERA SILICÓN-MOTOR A TUBO	SIH250363C
POLEA DEL TENSOR-TOMA DE FUERZA-ALT-AA	38075	MANGUERA SILICÓN-MOTOR A ENFRIADOR	SIH275363C
TENSOR-TOMA DE FUERZA-ALT-AA	38501	MANGUERA SILICÓN-ENFRIADOR A TUBO	SIH275363C
MANGUERA INFERIOR-RAD. A TUBO	21891	BANDA-ALT-AA	K080580



MASTER SERVICIO PESADO 2014

FREIGHTLINER

ARGOSY

POLEA DEL TENSOR-ALT-AA	38075	TERMOSTATO-170°	33577
TENSOR-ALT-AA	38501	1999	
TERMOSTATO-190°	33599	TERMOSTATO-190°	33579
2000		TERMOSTATO-180°	33576
BANDA-VENT	K100579	TERMOSTATO-180°	33578
POLEA DEL TENSOR-VENT	38076	TERMOSTATO-170°	33577
TENSOR-VENT	38503	CUMMINS ISX DIESEL	
MANGUERA INFERIOR-RAD. A TUBO	21891	2003	
MANGUERA SILICÓN-RAD. A TUBO	SIH250363C	POLEA DEL TENSOR-VENT	36092
MANGUERA SILICÓN-MOTOR A TUBO	SIH250363C	TENSOR-VENT	38535
MANGUERA SILICÓN-MOTOR A ENFRIADOR	SIH275363C	POLEA DEL TENSOR-TOMA DE FUERZA-ALT-AA	36095
MANGUERA SILICÓN-ENFRIADOR A TUBO	SIH275363C	TENSOR-TOMA DE FUERZA-ALT-AA	38532
BANDA-ALT-AA	K080580	BANDA-BA-VENT	K060685
POLEA DEL TENSOR-ALT-AA	38075	BANDA-ALT-BA-AA	K100710
TENSOR-ALT-AA	38501	2002	
TERMOSTATO-190°	33599	POLEA DEL TENSOR-VENT	36092
1999		TENSOR-VENT	38535
BANDA-VENT	9590	POLEA DEL TENSOR-TOMA DE FUERZA-ALT-AA	36095
BANDA-TOMA DE FUERZA-ALT-AA	K080585	TENSOR-TOMA DE FUERZA-ALT-AA	38532
POLEA DEL TENSOR-TOMA DE FUERZA-ALT-AA	38075	BANDA-BA-VENT	K060685
TENSOR-TOMA DE FUERZA-ALT-AA	38501	BANDA-ALT-BA-AA	K100710
MANGUERA INFERIOR-RAD. A TUBO	21891	2001	
MANGUERA SILICÓN-RAD. A TUBO	SIH250363C	POLEA DEL TENSOR-VENT	36092
MANGUERA SILICÓN-MOTOR A TUBO	SIH250363C	TENSOR-VENT	38535
MANGUERA SILICÓN-MOTOR A ENFRIADOR	SIH275363C	POLEA DEL TENSOR-TOMA DE FUERZA-ALT-AA	36095
MANGUERA SILICÓN-ENFRIADOR A TUBO	SIH275363C	TENSOR-TOMA DE FUERZA-ALT-AA	38532
BANDA-ALT-AA	9600	BANDA-BA-VENT	K060685
TERMOSTATO-190°	33599	BANDA-ALT-BA-AA	K100710
CUMMINS N14 DIESEL		2000	
2002		POLEA DEL TENSOR-VENT	36092
TERMOSTATO-190°	33579	TENSOR-VENT	38535
TERMOSTATO-180°	33576	POLEA DEL TENSOR-TOMA DE FUERZA-ALT-AA	36095
TERMOSTATO-180°	33578	TENSOR-TOMA DE FUERZA-ALT-AA	38532
TERMOSTATO-170°	33577	BANDA-BA-VENT	K060685
2001		BANDA-ALT-BA-AA	K100710
TERMOSTATO-190°	33579	1999	
TERMOSTATO-180°	33576	POLEA DEL TENSOR-VENT	36092
TERMOSTATO-180°	33578	TENSOR-VENT	38535
TERMOSTATO-170°	33577	POLEA DEL TENSOR-TOMA DE FUERZA-ALT-AA	36095
2000		TENSOR-TOMA DE FUERZA-ALT-AA	38532
TERMOSTATO-190°	33579	BANDA-BA-VENT	K060685
TERMOSTATO-180°	33576	BANDA-ALT-BA-AA	K100710
TERMOSTATO-180°	33578	CUMMINS ISM DIESEL	



MASTER SERVICIO PESADO 2014

FREIGHTLINER

ARGOSY

2000		TERMOSTATO-170°	33577
MANGUERA SILICÓN-TUBO A RAD.	SIH250363C	2002	
MANGUERA SILICÓN-MOTOR A TUBO	SIH250363C	BANDA-VENT-AA	K060547
MANGUERA SUPERIOR-MOTOR A TUBO	24436	POLEA DEL TENSOR-VENT-AA	36091
BANDA-ALT-VENT	K080708	TENSOR-VENT-AA	38508
TENSOR-ALT-VENT	38521	MANGUERA INFERIOR-RAD. A TUBO	21891
BANDA-	9412	MANGUERA SILICÓN-RAD. A TUBO	SIH250363C
1999		MANGUERA INFERIOR-MOTOR A TUBO	21400
MANGUERA SILICÓN-RAD. A TUBO	SIH250363C	MANGUERA SILICÓN-MOTOR A TUBO	SIH250363C
MANGUERA SUPERIOR-RAD. A TUBO	21891	BANDA-ALT-VENT	K080952
MANGUERA SILICÓN-MOTOR A TUBO	SIH250363C	POLEA-ALT-VENT	36091
MANGUERA SUPERIOR-MOTOR A TUBO	24436	TENSOR-ALT-VENT	38506
BANDA-ALT-VENT	K080730	TERMOSTATO-190°	33579
CATERPILLAR C15 DIESEL		TERMOSTATO-180°	33576
2004		TERMOSTATO-180°	33578
BANDA-VENT-AA	K060547	TERMOSTATO-170°	33577
POLEA DEL TENSOR-VENT-AA	36091	2001	
TENSOR-VENT-AA	38508	BANDA-VENT-AA	K060547
MANGUERA INFERIOR-RAD. A TUBO	21891	POLEA DEL TENSOR-VENT-AA	36091
MANGUERA SILICÓN-RAD. A TUBO	SIH250363C	TENSOR-VENT-AA	38508
MANGUERA INFERIOR-MOTOR A TUBO	21400	MANGUERA INFERIOR-RAD. A TUBO	21891
MANGUERA SILICÓN-MOTOR A TUBO	SIH250363C	MANGUERA SILICÓN-RAD. A TUBO	SIH250363C
BANDA-ALT-VENT	K080952	MANGUERA INFERIOR-MOTOR A TUBO	21400
POLEA-ALT-VENT	36091	MANGUERA SILICÓN-MOTOR A TUBO	SIH250363C
TENSOR-ALT-VENT	38506	BANDA-ALT-VENT	K080952
TERMOSTATO-190°	33579	POLEA-ALT-VENT	36091
TERMOSTATO-180°	33576	TENSOR-ALT-VENT	38506
TERMOSTATO-180°	33578	TERMOSTATO-190°	33579
TERMOSTATO-170°	33577	TERMOSTATO-180°	33576
2003		TERMOSTATO-180°	33578
BANDA-VENT-AA	K060547	TERMOSTATO-170°	33577
POLEA DEL TENSOR-VENT-AA	36091	CATERPILLAR C12 DIESEL	
TENSOR-VENT-AA	38508	2004	
MANGUERA INFERIOR-RAD. A TUBO	21891	BANDA-VENT-AA	K060523
MANGUERA SILICÓN-RAD. A TUBO	SIH250363C	POLEA DEL TENSOR-VENT-AA	36091
MANGUERA INFERIOR-MOTOR A TUBO	21400	TENSOR-VENT-AA	38524
MANGUERA SILICÓN-MOTOR A TUBO	SIH250363C	POLEA DEL TENSOR-TOMA DE FUERZA-ALT-VENT	36091
BANDA-ALT-VENT	K080952	TENSOR-TOMA DE FUERZA-ALT-VENT	38506
POLEA-ALT-VENT	36091	BANDA-ALT-VENT	K080855
TENSOR-ALT-VENT	38506	POLEA-ALT-VENT	36091
TERMOSTATO-190°	33579	TERMOSTATO-190°	33579
TERMOSTATO-180°	33576	TERMOSTATO-180°	33576
TERMOSTATO-180°	33578	TERMOSTATO-180°	33578



MASTER SERVICIO PESADO 2014

FREIGHTLINER

ARGOSY

TERMOSTATO-170°	33577	BANDA-ALT-VENT	K080855
2003		POLEA-ALT-VENT	36091
BANDA-VENT-AA	K060523	TERMOSTATO-190°	33579
POLEA DEL TENSOR-VENT-AA	36091	TERMOSTATO-180°	33576
TENSOR-VENT-AA	38524	TERMOSTATO-180°	33578
POLEA DEL TENSOR-TOMA DE FUERZA-ALT-VENT	36091	TERMOSTATO-170°	33577
TENSOR-TOMA DE FUERZA-ALT-VENT	38506	1999	
BANDA-ALT-VENT	K080855	POLEA-ALT-VENT	36091
POLEA-ALT-VENT	36091	TERMOSTATO-190°	33579
TERMOSTATO-190°	33579	TERMOSTATO-180°	33576
TERMOSTATO-180°	33576	TERMOSTATO-180°	33578
TERMOSTATO-180°	33578	TERMOSTATO-170°	33577
TERMOSTATO-170°	33577	CATERPILLAR C10 DIESEL	
2002		2003	
BANDA-VENT-AA	K060523	BANDA-VENT-AA	K060523
POLEA DEL TENSOR-VENT-AA	36091	POLEA DEL TENSOR-VENT-AA	36091
TENSOR-VENT-AA	38524	TENSOR-VENT-AA	38524
POLEA DEL TENSOR-TOMA DE FUERZA-ALT-VENT	36091	POLEA DEL TENSOR-TOMA DE FUERZA-ALT-VENT	36091
TENSOR-TOMA DE FUERZA-ALT-VENT	38506	TENSOR-TOMA DE FUERZA-ALT-VENT	38506
BANDA-ALT-VENT	K080855	BANDA-ALT-VENT	K080855
POLEA-ALT-VENT	36091	POLEA-ALT-VENT	36091
TERMOSTATO-190°	33579	TERMOSTATO-190°	33579
TERMOSTATO-180°	33576	TERMOSTATO-180°	33576
TERMOSTATO-180°	33578	TERMOSTATO-180°	33578
TERMOSTATO-170°	33577	TERMOSTATO-170°	33577
2001		2002	
BANDA-VENT-AA	K060523	BANDA-VENT-AA	K060523
POLEA DEL TENSOR-VENT-AA	36091	POLEA DEL TENSOR-VENT-AA	36091
TENSOR-VENT-AA	38524	TENSOR-VENT-AA	38524
POLEA DEL TENSOR-TOMA DE FUERZA-ALT-VENT	36091	POLEA DEL TENSOR-TOMA DE FUERZA-ALT-VENT	36091
TENSOR-TOMA DE FUERZA-ALT-VENT	38506	TENSOR-TOMA DE FUERZA-ALT-VENT	38506
BANDA-ALT-VENT	K080855	BANDA-ALT-VENT	K080855
POLEA-ALT-VENT	36091	POLEA-ALT-VENT	36091
TERMOSTATO-190°	33579	TERMOSTATO-190°	33579
TERMOSTATO-180°	33576	TERMOSTATO-180°	33576
TERMOSTATO-180°	33578	TERMOSTATO-180°	33578
TERMOSTATO-170°	33577	TERMOSTATO-170°	33577
2000		2001	
BANDA-VENT-AA	K060523	BANDA-VENT-AA	K060523
POLEA DEL TENSOR-VENT-AA	36091	POLEA DEL TENSOR-VENT-AA	36091
TENSOR-VENT-AA	38524	TENSOR-VENT-AA	38524
POLEA DEL TENSOR-TOMA DE FUERZA-ALT-VENT	36091	POLEA DEL TENSOR-TOMA DE FUERZA-ALT-VENT	36091
TENSOR-TOMA DE FUERZA-ALT-VENT	38506	TENSOR-TOMA DE FUERZA-ALT-VENT	38506



MASTER SERVICIO PESADO 2014

FREIGHTLINER

ARGOSY

BANDA-ALT-VENT	K080855	1999	
POLEA-ALT-VENT	36091	BANDA-VENT-AA	K060547
TERMOSTATO-190°	33579	MANGUERA INFERIOR-RAD. A TUBO	21891
TERMOSTATO-180°	33576	MANGUERA SILICÓN-RAD. A TUBO	SIH250363C
TERMOSTATO-180°	33578	MANGUERA INFERIOR-MOTOR A TUBO	21400
TERMOSTATO-170°	33577	MANGUERA SILICÓN-MOTOR A TUBO	SIH250363C
2000		BANDA-ALT-VENT	K080952
BANDA-VENT-AA	K060523	TERMOSTATO-190°	33579
POLEA DEL TENSOR-VENT-AA	36091	TERMOSTATO-180°	33576
TENSOR-VENT-AA	38524	TERMOSTATO-180°	33578
POLEA DEL TENSOR-TOMA DE FUERZA-ALT-VENT	36091	TERMOSTATO-170°	33577
TENSOR-TOMA DE FUERZA-ALT-VENT	38506	BUSINESS CLASS M2	
BANDA-ALT-VENT	K080855	MERCEDES-BENZ MBE 900 DIESEL	
POLEA-ALT-VENT	36091	2007	
TERMOSTATO-190°	33579	BANDA-VENT	K080615
TERMOSTATO-180°	33576	TENSOR-VENT	38598
TERMOSTATO-180°	33578	MANGUERA INFERIOR-TUBO A ENFRIADOR	20206
TERMOSTATO-170°	33577	MANGUERA INFERIOR-RAD. A TUBO	24032
1999		MANGUERA SILICÓN-RAD. A TUBO	SIH250363C
POLEA-ALT-VENT	36091	MANGUERA INFERIOR-MOTOR A TUBO	20206
TERMOSTATO-190°	33579	MANGUERA SILICÓN-MOTOR A TUBO	SIH200363C
TERMOSTATO-180°	33576	MANGUERA SUPERIOR-MOTOR A RAD.	21378
TERMOSTATO-180°	33578	MANGUERA SILICÓN-ENFRIADOR A TUBO	SIH200363C
TERMOSTATO-170°	33577	BANDA-ALT-VENT-AA	K080825
CATERPILLAR 3406 DIESEL		BANDA-ALT-BA-AA	K080825
2002		TENSOR-ALT-AA	38567
TERMOSTATO-175°	33549	2006	
2001		BANDA-VENT	K080615
TERMOSTATO-190°	33579	TENSOR-VENT	38598
TERMOSTATO-180°	33576	MANGUERA INFERIOR-TUBO A ENFRIADOR	20206
TERMOSTATO-180°	33578	MANGUERA INFERIOR-RAD. A TUBO	24032
TERMOSTATO-170°	33577	MANGUERA SILICÓN-RAD. A TUBO	SIH250363C
2000		MANGUERA INFERIOR-MOTOR A TUBO	20206
BANDA-VENT-AA	K060547	MANGUERA SILICÓN-MOTOR A TUBO	SIH200363C
MANGUERA INFERIOR-RAD. A TUBO	21891	MANGUERA SUPERIOR-MOTOR A RAD.	21378
MANGUERA SILICÓN-RAD. A TUBO	SIH250363C	MANGUERA SILICÓN-ENFRIADOR A TUBO	SIH200363C
MANGUERA INFERIOR-MOTOR A TUBO	21400	BANDA-ALT-VENT-AA	K080825
MANGUERA SILICÓN-MOTOR A TUBO	SIH250363C	BANDA-ALT-BA-AA	K080825
BANDA-ALT-VENT	K080952	TENSOR-ALT-AA	38567
TERMOSTATO-190°	33579	2005	
TERMOSTATO-180°	33576	MANGUERA SILICÓN-RAD. A TUBO	SIH200363C
TERMOSTATO-180°	33578	MANGUERA INFERIOR-MOTOR A TUBO	20206
TERMOSTATO-170°	33577	MANGUERA SUPERIOR-MOTOR A RAD.	21378



TENSOR-MOTOR	38567	MANGUERA SUPERIOR-MOTOR A RAD.	22959
BANDA-ALT-VENT-AA	K080830	2004	
2004		BANDA-VENT	K080575
MANGUERA SILICÓN-RAD. A TUBO	SIH200363C	TENSOR-VENT	38597
MANGUERA INFERIOR-MOTOR A TUBO	20206	BANDA-TOMA DE FUERZA-ALT-AA	K080855
MANGUERA SUPERIOR-MOTOR A RAD.	21378	POLEA DEL TENSOR-TOMA DE FUERZA-ALT-AA	38075
TENSOR-MOTOR	38567	TENSOR-TOMA DE FUERZA-ALT-AA	38501
BANDA-ALT-VENT-AA	K080830	MANGUERA INFERIOR-MOTOR A RAD.	23014
BANDA-ALT-VENT	K080677	MANGUERA SUPERIOR-MOTOR A RAD.	23013
2003		MERCEDES BENZ MBE 900 DIESEL	
MANGUERA SILICÓN-TUBO A RAD.	SIH200363C	2008	
MANGUERA SUPERIOR-MOTOR A RAD.	21378	MANGUERA INFERIOR-RAD. A TUBO	20206
BANDA-ALT-VENT-AA	K080830	MANGUERA SILICÓN-RAD. A TUBO	SIH200363C
BANDA-ALT-VENT	K080677	MANGUERA INFERIOR-MOTOR A TUBO	20206
2002		MANGUERA SILICÓN-MOTOR A TUBO	SIH200363C
MANGUERA SILICÓN-TUBO A RAD.	SIH200363C	BANDA-ALT-VENT-AA	K080825
MANGUERA SUPERIOR-MOTOR A RAD.	21378	TENSOR-ALT-AA	38567
BANDA-ALT-VENT-AA	K080830	MERCEDES BENZ MBE 4000 Diesel	
BANDA-ALT-VENT	K080677	2010	
MERCEDES-BENZ MBE 4000 DIESEL		BANDA-VENT	K080505
2007		2009	
BANDA-VENT	K080505	BANDA-VENT	K080505
TENSOR-VENT	38597	2008	
BANDA-TOMA DE FUERZA-ALT-AA	K080855	BANDA-VENT	K080505
POLEA DEL TENSOR-TOMA DE FUERZA-ALT-AA	38075	2007	
TENSOR-TOMA DE FUERZA-ALT-AA	38501	BANDA-VENT	K080505
MANGUERA INFERIOR-MOTOR A RAD.	23171	CUMMINS ISC DIESEL	
MANGUERA SUPERIOR-MOTOR A RAD.	22959	2011	
2006		MANGUERA SILICÓN-RAD. A TUBO	SIH200363C
BANDA-VENT	K080505	MANGUERA INFERIOR-MOTOR A TUBO	24436
TENSOR-VENT	38597	MANGUERA SUPERIOR-MOTOR A TUBO	24436
BANDA-TOMA DE FUERZA-ALT-AA	K080855	POLEA-MOTOR	36283
POLEA DEL TENSOR-TOMA DE FUERZA-ALT-AA	38075	TENSOR-MOTOR	38627
TENSOR-TOMA DE FUERZA-ALT-AA	38501	BANDA-ALT-VENT-AA	K080820
MANGUERA INFERIOR-MOTOR A RAD.	23171	TERMOSTATO-180°-C/DOBLE TERMOSTATO	33966
MANGUERA SUPERIOR-MOTOR A RAD.	22959	TERMOSTATO-180°	33959
2005		BOMBA DE AGUA-	42146HD
BANDA-VENT	K080505	2010	
TENSOR-VENT	38597	MANGUERA SILICÓN-RAD. A TUBO	SIH200363C
BANDA-TOMA DE FUERZA-ALT-AA	K080855	MANGUERA INFERIOR-MOTOR A TUBO	24436
POLEA DEL TENSOR-TOMA DE FUERZA-ALT-AA	38075	MANGUERA SUPERIOR-MOTOR A TUBO	24436
TENSOR-TOMA DE FUERZA-ALT-AA	38501	POLEA-MOTOR	36283
MANGUERA INFERIOR-MOTOR A RAD.	23171	TENSOR-MOTOR	38627
		BANDA-ALT-VENT-AA	K080820



MASTER SERVICIO PESADO 2014

FREIGHTLINER

BUSINESS CLASS M2

TERMOSTATO-180°-C/DOBLE TERMOSTATO	33966	TERMOSTATO-180°	33959
TERMOSTATO-180°	33959	2004	
BOMBA DE AGUA-	42146HD	MANGUERA INFERIOR-RAD. A TUBO	21891
2009		MANGUERA SILICÓN-RAD. A TUBO	SIH200363C
MANGUERA SILICÓN-RAD. A TUBO	SIH200363C	MANGUERA SUPERIOR-MOTOR A TUBO	24436
MANGUERA INFERIOR-MOTOR A TUBO	24436	BANDA-ALT-VENT	K080716
MANGUERA SUPERIOR-MOTOR A TUBO	24436	POLEA-ALT-VENT	36093
POLEA-MOTOR	36283	SENSOR-ALT-VENT	38516
SENSOR-MOTOR	38627	TERMOSTATO-180°-C/DOBLE TERMOSTATO	33966
BANDA-ALT-VENT-AA	K080820	TERMOSTATO-180°	33959
TERMOSTATO-180°-C/DOBLE TERMOSTATO	33966	CUMMINS ISB-07 DIESEL	
TERMOSTATO-180°	33959	2008	
BOMBA DE AGUA-	42146HD	MANGUERA SILICÓN-RAD. A TUBO	SIH200363C
2008		MANGUERA SILICÓN-MOTOR A TUBO	SIH200363C
MANGUERA SILICÓN-RAD. A TUBO	SIH200363C	BANDA-ALT-VENT-AA	K080816
MANGUERA INFERIOR-MOTOR A TUBO	24436	TERMOSTATO-190°	33915
MANGUERA SUPERIOR-MOTOR A TUBO	24436	TERMOSTATO-180°	33956
POLEA-MOTOR	36283	CUMMINS ISB DIESEL	
SENSOR-MOTOR	38627	2007	
BANDA-ALT-VENT-AA	K080820	MANGUERA SILICÓN-RAD. A TUBO	SIH200363C
TERMOSTATO-180°-C/DOBLE TERMOSTATO	33966	MANGUERA SILICÓN-MOTOR A TUBO	SIH200363C
TERMOSTATO-180°	33959	BANDA-ALT-VENT-AA	K080816
BOMBA DE AGUA-	42146HD	TERMOSTATO-190°	33915
2007		TERMOSTATO-180°	33956
MANGUERA SILICÓN-RAD. A TUBO	SIH200363C	CATERPILLAR C9 DIESEL	
MANGUERA INFERIOR-MOTOR A TUBO	24436	2009	
MANGUERA SUPERIOR-MOTOR A TUBO	24436	TERMOSTATO-190°	33579
POLEA-MOTOR	36283	TERMOSTATO-180°	33576
SENSOR-MOTOR	38627	TERMOSTATO-180°	33578
BANDA-ALT-VENT-AA	K080820	TERMOSTATO-170°	33577
TERMOSTATO-180°-C/DOBLE TERMOSTATO	33966	2008	
TERMOSTATO-180°	33959	TERMOSTATO-190°	33579
BOMBA DE AGUA-	42146HD	TERMOSTATO-180°	33576
2006		TERMOSTATO-180°	33578
BANDA-TOMA DE FUERZA-ALT-VENT-AA	K080820	TERMOSTATO-170°	33577
SENSOR-TOMA DE FUERZA-ALT-VENT-AA	38516	2007	
MANGUERA INFERIOR-RAD. A TUBO	21135	MANGUERA INFERIOR-MOTOR A RAD.	23173
MANGUERA SILICÓN-MOTOR A TUBO	SIH250363C	MANGUERA SUPERIOR-MOTOR A RAD.	23085
MANGUERA SUPERIOR-MOTOR A RAD.	23170	BANDA-ALT-VENT-AA	K080785
TERMOSTATO-180°-C/DOBLE TERMOSTATO	33966	SENSOR-ALT-VENT-AA	38550
TERMOSTATO-180°	33959	TERMOSTATO-190°	33579
2005		TERMOSTATO-180°	33576
TERMOSTATO-180°-C/DOBLE TERMOSTATO	33966	TERMOSTATO-180°	33578



MASTER SERVICIO PESADO 2014

FREIGHTLINER

BUSINESS CLASS M2

TERMOSTATO-170°	33577	BANDA-ALT-VENT-AA	K080774
2006		TENSOR-ALT-VENT-AA	38550
MANGUERA INFERIOR-MOTOR A RAD.	23173	TERMOSTATO-190°	33969
MANGUERA SUPERIOR-MOTOR A RAD.	23085	TERMOSTATO-180°	33968
BANDA-ALT-VENT-AA	K080785	POLEA-	36096
TENSOR-ALT-VENT-AA	38550	2006	
TERMOSTATO-190°	33579	MANGUERA INFERIOR-TUBO A ENFRIADOR	21128
TERMOSTATO-180°	33576	MANGUERA SILICÓN-RAD. A TUBO	SIH250363C
TERMOSTATO-180°	33578	MANGUERA SILICÓN-MOTOR A TUBO	SIH200363C
TERMOSTATO-170°	33577	MANGUERA SUPERIOR-MOTOR A RAD.	22745
2005		POLEA-MOTOR	36091
MANGUERA INFERIOR-MOTOR A RAD.	23173	MANGUERA INFERIOR-ENFRIADOR A TUBO	21128
MANGUERA SUPERIOR-MOTOR A RAD.	23085	BANDA-ALT-VENT-AA C/130A	K080780
BANDA-ALT-VENT-AA	K080785	BANDA-ALT-VENT-AA	K080774
TENSOR-ALT-VENT-AA	38550	TENSOR-ALT-VENT-AA	38550
TERMOSTATO-190°	33579	TERMOSTATO-190°	33969
TERMOSTATO-180°	33576	TERMOSTATO-180°	33968
TERMOSTATO-180°	33578	2005	
TERMOSTATO-170°	33577	MANGUERA SILICÓN-RAD. A TUBO	SIH250363C
2004		MANGUERA SILICÓN-MOTOR A TUBO	SIH250363C
MANGUERA INFERIOR-MOTOR A RAD.	23173	MANGUERA SUPERIOR-MOTOR A RAD.	22745
MANGUERA SUPERIOR-MOTOR A RAD.	23085	POLEA-MOTOR	36091
BANDA-ALT-VENT-AA	K080785	BANDA-ALT-VENT-AA C/130A	K080780
TENSOR-ALT-VENT-AA	38550	BANDA-ALT-VENT-AA	K080774
TERMOSTATO-190°	33579	TENSOR-ALT-VENT-AA	38550
TERMOSTATO-180°	33576	TERMOSTATO-190°	33969
TERMOSTATO-180°	33578	TERMOSTATO-180°	33968
TERMOSTATO-170°	33577	2004	
CATERPILLAR C7 DIESEL		MANGUERA INFERIOR-MOTOR A RAD.	22744
2009		MANGUERA SUPERIOR-MOTOR A RAD.	22745
TERMOSTATO-190°	33969	POLEA-MOTOR	36091
TERMOSTATO-180°	33968	BANDA-ALT-VENT-AA C/130A	K080780
2008		BANDA-ALT-VENT-AA	K080774
TERMOSTATO-190°	33969	TENSOR-ALT-VENT-AA	38550
TERMOSTATO-180°	33968	TERMOSTATO-190°	33969
2007		TERMOSTATO-180°	33968
MANGUERA INFERIOR-TUBO A ENFRIADOR	21128	CATERPILLAR C13 DIESEL	
MANGUERA SILICÓN-RAD. A TUBO	SIH250363C	2010	
MANGUERA SILICÓN-MOTOR A TUBO	SIH200363C	BANDA-VENT-AA	K100953
MANGUERA SUPERIOR-MOTOR A RAD.	22745	TENSOR-VENT-AA	38646
POLEA-MOTOR	36091	MANGUERA INFERIOR-TUBO A RAD.	21891
MANGUERA INFERIOR-ENFRIADOR A TUBO	21128	MANGUERA INFERIOR-MOTOR A TUBO	24440
BANDA-ALT-VENT-AA C/130A	K080780	POLEA-ALT SUPERIOR	36227



MASTER SERVICIO PESADO 2014

FREIGHTLINER

BUSINESS CLASS M2

POLEA-ALT INFERIOR	36227	TERMOSTATO-180°	33578
BANDA-ALT	K060858	TERMOSTATO-170°	33577
TENSOR-ALT	38635	2005	
TERMOSTATO-190°	33579	BANDA-TOMA DE FUERZA-ALT-VENT-AA	K081005
TERMOSTATO-180°	33576	TENSOR-TOMA DE FUERZA-ALT-VENT-AA	38590
TERMOSTATO-180°	33578	MANGUERA INFERIOR-MOTOR A RAD.	22952
TERMOSTATO-170°	33577	MANGUERA SUPERIOR-MOTOR A RAD.	23086
2009		POLEA-MOTOR	36093
BANDA-VENT-AA	K100953	TERMOSTATO-190°	33579
TENSOR-VENT-AA	38646	TERMOSTATO-180°	33576
MANGUERA INFERIOR-TUBO A RAD.	21891	TERMOSTATO-180°	33578
MANGUERA INFERIOR-MOTOR A TUBO	24440	TERMOSTATO-170°	33577
POLEA-ALT SUPERIOR	36227	2004	
POLEA-ALT INFERIOR	36227	BANDA-TOMA DE FUERZA-ALT-VENT-AA	K081005
BANDA-ALT	K060858	TENSOR-TOMA DE FUERZA-ALT-VENT-AA	38590
TENSOR-ALT	38635	MANGUERA INFERIOR-MOTOR A RAD.	22952
TERMOSTATO-190°	33579	MANGUERA SUPERIOR-MOTOR A RAD.	23086
TERMOSTATO-180°	33576	POLEA-MOTOR	36093
TERMOSTATO-180°	33578	TERMOSTATO-190°	33579
TERMOSTATO-170°	33577	TERMOSTATO-180°	33576
2008		TERMOSTATO-180°	33578
TERMOSTATO-190°	33579	TERMOSTATO-170°	33577
TERMOSTATO-180°	33576	CATERPILLAR C11 DIESEL	
TERMOSTATO-180°	33578	2007	
TERMOSTATO-170°	33577	TERMOSTATO-190°	33579
2007		TERMOSTATO-180°	33576
BANDA-TOMA DE FUERZA-ALT-VENT-AA	K080952	TERMOSTATO-180°	33578
TENSOR-TOMA DE FUERZA-ALT-VENT-AA	38590	TERMOSTATO-170°	33577
MANGUERA INFERIOR-MOTOR A RAD.	22952	2006	
MANGUERA SUPERIOR-MOTOR A RAD.	23086	TERMOSTATO-190°	33579
POLEA-MOTOR	36093	TERMOSTATO-180°	33576
TERMOSTATO-190°	33579	TERMOSTATO-180°	33578
TERMOSTATO-180°	33576	TERMOSTATO-170°	33577
TERMOSTATO-180°	33578	2005	
TERMOSTATO-170°	33577	TERMOSTATO-190°	33579
2006		TERMOSTATO-180°	33576
BANDA-TOMA DE FUERZA-ALT-VENT-AA	K080952	TERMOSTATO-180°	33578
TENSOR-TOMA DE FUERZA-ALT-VENT-AA	38590	TERMOSTATO-170°	33577
MANGUERA INFERIOR-MOTOR A RAD.	22952	2004	
MANGUERA SUPERIOR-MOTOR A RAD.	23086	TERMOSTATO-190°	33579
POLEA-MOTOR	36093	TERMOSTATO-180°	33576
TERMOSTATO-190°	33579	TERMOSTATO-180°	33578
TERMOSTATO-180°	33576	TERMOSTATO-170°	33577



MASTER SERVICIO PESADO 2014

FREIGHTLINER

BUSINESS CLASS M2

CATERPILLAR 3126 DIESEL

2007

MANGUERA INFERIOR-TUBO A ENFRIADOR	21128
MANGUERA SILICÓN-RAD. A TUBO	SIH250363C
MANGUERA SILICÓN-MOTOR A TUBO	SIH200363C
MANGUERA SUPERIOR-MOTOR A RAD.	22745
POLEA-MOTOR	36091
MANGUERA INFERIOR-ENFRIADOR A TUBO	21128
BANDA-ALT-VENT-AA C/130A	K080780
BANDA-ALT-VENT-AA	K080774
TENSOR-ALT-VENT-AA	38550
TERMOSTATO-190°	33969
TERMOSTATO-180°	33968
POLEA-	36096

2004

MANGUERA INFERIOR-MOTOR A RAD.	22744
MANGUERA SUPERIOR-MOTOR A RAD.	22745
BANDA-ALT-VENT-AA C/130A	K080780
BANDA-ALT-VENT-AA	K080774
TENSOR-ALT-VENT-AA	38550
TERMOSTATO-190°	33969
TERMOSTATO-180°	33968

2003

MANGUERA INFERIOR-MOTOR A RAD.	22744
MANGUERA SUPERIOR-MOTOR A RAD.	22745
BANDA-ALT-VENT-AA C/130A	K080780
BANDA-ALT-VENT-AA	K080774
TENSOR-ALT-VENT-AA	38550
TERMOSTATO-190°	33969
TERMOSTATO-180°	33968

2002

MANGUERA INFERIOR-MOTOR A RAD.	22744
MANGUERA SUPERIOR-MOTOR A RAD.	22745
BANDA-ALT-VENT-AA C/ALT 145A	K080774
BANDA-ALT-VENT-AA C/130A	K080780
TENSOR-ALT-VENT-AA	38550
TERMOSTATO-190°	33969
TERMOSTATO-180°	33968

CASCADIA

MERCEDES BENZ MBE 4000 Diesel

2012

BANDA-VENT	K080505
TENSOR-VENT	38597

MANGUERA INFERIOR-TUBO A RAD.	24047
MANGUERA SUPERIOR-TUBO A RAD.	21891
MANGUERA INFERIOR-MOTOR A TUBO	26045
MANGUERA SUPERIOR-MOTOR A TUBO	24440
BANDA-AA	K080855
POLEA DEL TENSOR-AA	38075
TENSOR-AA	38501

2011

BANDA-VENT	K080505
TENSOR-VENT	38597
MANGUERA INFERIOR-TUBO A RAD.	24047
MANGUERA SUPERIOR-TUBO A RAD.	21891
MANGUERA INFERIOR-MOTOR A TUBO	26045
MANGUERA SUPERIOR-MOTOR A TUBO	24440
BANDA-AA	K080855
POLEA DEL TENSOR-AA	38075
TENSOR-AA	38501

2010

BANDA-VENT	K080505
TENSOR-VENT	38597
MANGUERA INFERIOR-TUBO A RAD.	24047
MANGUERA SUPERIOR-TUBO A RAD.	21891
MANGUERA INFERIOR-MOTOR A TUBO	26045
MANGUERA SUPERIOR-MOTOR A TUBO	24440
BANDA-AA	K080855
POLEA DEL TENSOR-AA	38075
TENSOR-AA	38501

2009

BANDA-VENT	K080505
TENSOR-VENT	38597
MANGUERA INFERIOR-TUBO A RAD.	24047
MANGUERA SUPERIOR-TUBO A RAD.	21891
MANGUERA INFERIOR-MOTOR A TUBO	26045
MANGUERA SUPERIOR-MOTOR A TUBO	24440
BANDA-AA	K080855
POLEA DEL TENSOR-AA	38075
TENSOR-AA	38501

2008

BANDA-VENT	K080505
TENSOR-VENT	38597
MANGUERA INFERIOR-TUBO A RAD.	24047
MANGUERA SUPERIOR-TUBO A RAD.	21891
MANGUERA INFERIOR-MOTOR A TUBO	26045



MASTER SERVICIO PESADO 2014

FREIGHTLINER

CASCADIA

MANGUERA SUPERIOR-MOTOR A TUBO	24440	TERMOSTATO-170°	33577
BANDA-AA	K080855	BOMBA DE AGUA-	44062HD
POLEA DEL TENSOR-AA	38075	2008	
TENSOR-AA	38501	TERMOSTATO-190°	33579
DETROIT DIESEL 6 CIL, 14.0 L DIESEL		TERMOSTATO-180°	33576
2010		TERMOSTATO-180°	33578
BANDA-VENT	K100502	TERMOSTATO-170°	33577
POLEA DEL TENSOR-VENT	38076	BOMBA DE AGUA-	44062HD
TENSOR-VENT	38503	CENTURY CLASS	
MANGUERA INFERIOR-RAD. A TUBO	21891	MERCEDES-BENZ MBE 4000 DIESEL	
MANGUERA SILICÓN-RAD. A TUBO	SIH250363C	2005	
MANGUERA SILICÓN-MOTOR A TUBO	SIH250363C	BANDA-VENT	K080575
BANDA-ALT-AA	K080580	POLEA DEL TENSOR-VENT	38075
POLEA DEL TENSOR-ALT-AA	38075	TENSOR-VENT	38597
TENSOR-ALT-AA	38501	TENSOR-TOMA DE FUERZA-ALT-AA	38501
TERMOSTATO-190°	33599	MANGUERA SILICÓN-RAD. A TUBO	SIH250363C
2009		MANGUERA INFERIOR-MOTOR A RAD.	21891
BANDA-VENT	K100502	MANGUERA SILICÓN-MOTOR A RAD.	SIH250363C
POLEA DEL TENSOR-VENT	38076	BANDA-ALT-BA-AA	K080855
TENSOR-VENT	38503	2004	
MANGUERA INFERIOR-RAD. A TUBO	21891	BANDA-VENT	K080672
MANGUERA SILICÓN-RAD. A TUBO	SIH250363C	BANDA-TOMA DE FUERZA-ALT	K090609
MANGUERA SILICÓN-MOTOR A TUBO	SIH250363C	TENSOR-TOMA DE FUERZA-ALT	38541
BANDA-ALT-AA	K080580	MANGUERA SILICÓN-RAD. A TUBO	SIH250363C
POLEA DEL TENSOR-ALT-AA	38075	MANGUERA INFERIOR-MOTOR A RAD.	21891
TENSOR-ALT-AA	38501	MANGUERA SILICÓN-MOTOR A RAD.	SIH250363C
TERMOSTATO-190°	33599	BANDA-AA	K060439
2008		TENSOR-AA	38540
BANDA-VENT	K100502	2001	
POLEA DEL TENSOR-VENT	38076	BANDA-VENT	9510
TENSOR-VENT	38503	MANGUERA SILICÓN-TUBO A RAD.	SIH250363C
MANGUERA INFERIOR-RAD. A TUBO	21891	BANDA-TOMA DE FUERZA-ALT	K080565
MANGUERA SILICÓN-RAD. A TUBO	SIH250363C	MANGUERA SILICÓN-MOTOR A TUBO	SIH250363C
MANGUERA SILICÓN-MOTOR A TUBO	SIH250363C	BANDA-AA	K080560
BANDA-ALT-AA	K080580	TENSOR-AA	38501
POLEA DEL TENSOR-ALT-AA	38075	POLEA DEL TENSOR-	38075
TENSOR-ALT-AA	38501	MERCEDES BENZ MBE 4000 Diesel	
TERMOSTATO-190°	33599	2010	
CATERPILLAR C15 DIESEL		BANDA-VENT	K080505
2009		TENSOR-VENT	38597
TERMOSTATO-190°	33579	MANGUERA INFERIOR-TUBO A RAD.	24047
TERMOSTATO-180°	33576	MANGUERA SUPERIOR-TUBO A RAD.	21891
TERMOSTATO-180°	33578	MANGUERA INFERIOR-MOTOR A TUBO	26045



MASTER SERVICIO PESADO 2014

FREIGHTLINER

CENTURY CLASS

MANGUERA SUPERIOR-MOTOR A TUBO	24440	TENSOR-	38506
BANDA-AA	K080855	2002	
POLEA DEL TENSOR-AA	38075	BANDA-VENT	PQ17500
TENSOR-AA	38501	MANGUERA SUPERIOR-TUBO A RAD.	CHARTER 2 1/2"
2009		BANDA-TOMA DE FUERZA-ALT-AA (ALT. 135A)	K080560
BANDA-VENT	K080505	BANDA-TOMA DE FUERZA-ALT-AA (ALT. 130A)	K080570
TENSOR-VENT	38597	BANDA-TOMA DE FUERZA-ALT-AA	K080570
MANGUERA INFERIOR-TUBO A RAD.	24047	POLEA-TOMA DE FUERZA-ALT-AA	38075
MANGUERA SUPERIOR-TUBO A RAD.	21891	TENSOR-TOMA DE FUERZA-ALT-AA	38501
MANGUERA INFERIOR-MOTOR A TUBO	26045	MANGUERA SUPERIOR-MOTOR A TUBO	21891
MANGUERA SUPERIOR-MOTOR A TUBO	24440	MANGUERA INFERIOR-	CHARTER 2 1/2"
BANDA-AA	K080855	2001	
POLEA DEL TENSOR-AA	38075	BANDA-VENT	PQ17500
TENSOR-AA	38501	MANGUERA SUPERIOR-TUBO A RAD.	CHARTER 2 1/2"
DETROIT DIESEL SERIES 55 DIESEL		BANDA-TOMA DE FUERZA-ALT-AA (ALT. 135A)	K080560
1998		BANDA-TOMA DE FUERZA-ALT-AA (ALT. 130A)	K080570
BANDA-VENT	K060470	MANGUERA SUPERIOR-MOTOR A TUBO	21891
TERMOSTATO-190°	33599	MANGUERA INFERIOR-	CHARTER 2 1/2"
1997		2000	
BANDA-VENT	K060470	BANDA-VENT	PQ17510
TERMOSTATO-190°	33599	MANGUERA SUPERIOR-TUBO A RAD.	CHARTER 2 1/2"
MANGUERA SILICÓN-	SIH250363C	BANDA-TOMA DE FUERZA-ALT-AA	K080580
1996		MANGUERA SUPERIOR-MOTOR A TUBO	21891
TERMOSTATO-190°	33599	MANGUERA INFERIOR-	CHARTER 2 1/2"
DETROIT DIESEL SERIE 60		1999	
2005		BANDA-VENT	PQ17500
BANDA-VENT	K100502	BANDA-VENT	PQ17510
POLEA-VENT	38076	MANGUERA SUPERIOR-TUBO A RAD.	CHARTER 2 1/2"
TENSOR-VENT	38503	BANDA-TOMA DE FUERZA-ALT-AA	2/9510PB
BANDA-TOMA DE FUERZA-ALT-AA	K080565	BANDA-TOMA DE FUERZA-ALT-AA	K080580
POLEA-TOMA DE FUERZA-ALT-AA	38075	BANDA-TOMA DE FUERZA-ALT-AA	PQ17510
TENSOR-TOMA DE FUERZA-ALT-AA	38501	MANGUERA SUPERIOR-MOTOR A TUBO	21891
MANGUERA SUPERIOR-MOTOR A TUBO	CHARTER 2 1/2"	BANDA-ALT	2/9510PB
2003		BANDA-AA	PQ17510
BANDA-VENT	PQ17500	MANGUERA INFERIOR-	CHARTER 2 1/2"
MANGUERA SUPERIOR-TUBO A RAD.	CHARTER 2 1/2"	1998	
BANDA-TOMA DE FUERZA-ALT-AA (ALT. 135A)	K080560	BANDA-VENT	PQ17500
BANDA-TOMA DE FUERZA-ALT-AA (ALT. 130A)	K080570	BANDA-VENT	PQ17510
BANDA-TOMA DE FUERZA-ALT-AA	K080570	MANGUERA INFERIOR-TUBO A RAD.	21472
POLEA-TOMA DE FUERZA-ALT-AA	38075	MANGUERA SUPERIOR-TUBO A RAD.	CHARTER 2 1/2"
TENSOR-TOMA DE FUERZA-ALT-AA	38501	BANDA-TOMA DE FUERZA-ALT-AA	PQ17510
MANGUERA SUPERIOR-MOTOR A TUBO	21891	MANGUERA SUPERIOR-MOTOR A TUBO	21891
MANGUERA INFERIOR-	CHARTER 2 1/2"	BANDA-ALT-AA	2/9510PB



MASTER SERVICIO PESADO 2014

FREIGHTLINER

CENTURY CLASS

MANGUERA DE CALEFACCIÓN-	35B 5/8"	BANDA-VENT	K100502
MANGUERA DE CALEFACCIÓN-	CHARTER 3/4"	POLEA DEL TENSOR-VENT	38076
MANGUERA DE PASO-	CHARTER 1 3/4"	TENSOR-VENT	38503
MANGUERA DE PASO-	CHARTER 3"	BANDA-TOMA DE FUERZA-ALT-AA	K080565
MANGUERA INFERIOR-	CHARTER 2 1/2"	POLEA DEL TENSOR-TOMA DE FUERZA-ALT-AA	38075
1997		TENSOR-TOMA DE FUERZA-ALT-AA	38501
BANDA-VENT	PQ17500	MANGUERA SILICÓN-RAD. A TUBO	SIH250363C
BANDA-VENT	PQ17510	MANGUERA SILICÓN-MOTOR A TUBO	SIH250363C
BANDA-ALT-AA	2/9510PB	MANGUERA INFERIOR-MOTOR A RAD.	22877
DETROIT DIESEL 6 CIL, 14.0 L DIESEL		TERMOSTATO-190°	33599
2007		2003	
BANDA-VENT	K100502	BANDA-VENT- OPCIONAL	9500
POLEA DEL TENSOR-VENT	38076	BANDA-VENT	3/9500PB
TENSOR-VENT	38503	MANGUERA SILICÓN-TUBO A RAD.	SIH250363C
BANDA-TOMA DE FUERZA-ALT-AA	K080565	BANDA-TOMA DE FUERZA-ALT-AA	K080570
POLEA DEL TENSOR-TOMA DE FUERZA-ALT-AA	38075	POLEA DEL TENSOR-TOMA DE FUERZA-ALT-AA	38075
TENSOR-TOMA DE FUERZA-ALT-AA	38501	TENSOR-TOMA DE FUERZA-ALT-AA	38501
MANGUERA SILICÓN-RAD. A TUBO	SIH250363C	MANGUERA SILICÓN-MOTOR A TUBO	SIH250363C
MANGUERA SILICÓN-MOTOR A TUBO	SIH250363C	MANGUERA SUPERIOR-MOTOR A TUBO	21891
TERMOSTATO-190°	33599	TERMOSTATO-190°	33599
2006		DETROIT DIESEL 6 CIL, 12.7 L DIESEL	
BANDA-VENT	K100502	2007	
POLEA DEL TENSOR-VENT	38076	BANDA-VENT	K100502
TENSOR-VENT	38503	POLEA DEL TENSOR-VENT	38076
BANDA-TOMA DE FUERZA-ALT-AA	K080565	TENSOR-VENT	38503
POLEA DEL TENSOR-TOMA DE FUERZA-ALT-AA	38075	BANDA-TOMA DE FUERZA-ALT-AA	K080565
TENSOR-TOMA DE FUERZA-ALT-AA	38501	POLEA DEL TENSOR-TOMA DE FUERZA-ALT-AA	38075
MANGUERA SILICÓN-RAD. A TUBO	SIH250363C	TENSOR-TOMA DE FUERZA-ALT-AA	38501
MANGUERA SILICÓN-MOTOR A TUBO	SIH250363C	MANGUERA SILICÓN-RAD. A TUBO	SIH250363C
MANGUERA INFERIOR-MOTOR A RAD.	22877	MANGUERA SILICÓN-MOTOR A TUBO	SIH250363C
TERMOSTATO-190°	33599	TERMOSTATO-190°	33599
2005		2006	
BANDA-VENT	K100502	BANDA-VENT	K100502
POLEA DEL TENSOR-VENT	38076	POLEA DEL TENSOR-VENT	38076
TENSOR-VENT	38503	TENSOR-VENT	38503
BANDA-TOMA DE FUERZA-ALT-AA	K080565	BANDA-TOMA DE FUERZA-ALT-AA	K080565
POLEA DEL TENSOR-TOMA DE FUERZA-ALT-AA	38075	POLEA DEL TENSOR-TOMA DE FUERZA-ALT-AA	38075
TENSOR-TOMA DE FUERZA-ALT-AA	38501	TENSOR-TOMA DE FUERZA-ALT-AA	38501
MANGUERA SILICÓN-RAD. A TUBO	SIH250363C	MANGUERA SILICÓN-RAD. A TUBO	SIH250363C
MANGUERA SILICÓN-MOTOR A TUBO	SIH250363C	MANGUERA SILICÓN-MOTOR A TUBO	SIH250363C
MANGUERA INFERIOR-MOTOR A RAD.	22877	TERMOSTATO-190°	33599
TERMOSTATO-190°	33599	2005	
2004		BANDA-VENT	K100502



MASTER SERVICIO PESADO 2014

FREIGHTLINER

CENTURY CLASS

POLEA DEL TENSOR-VENT	38076	MANGUERA SILICÓN-TUBO A RAD.	SIH250363C
TENSOR-VENT	38503	BANDA-TOMA DE FUERZA-ALT-AA C/ALT 135A	K080565
BANDA-TOMA DE FUERZA-ALT-AA	K080565	BANDA-TOMA DE FUERZA-ALT-AA C/130 A	K080570
POLEA DEL TENSOR-TOMA DE FUERZA-ALT-AA	38075	POLEA DEL TENSOR-TOMA DE FUERZA-ALT-AA	38075
TENSOR-TOMA DE FUERZA-ALT-AA	38501	TENSOR-TOMA DE FUERZA-ALT-AA	38501
MANGUERA SILICÓN-RAD. A TUBO	SIH250363C	MANGUERA SILICÓN-MOTOR A TUBO	SIH250363C
MANGUERA SILICÓN-MOTOR A TUBO	SIH250363C	MANGUERA SUPERIOR-MOTOR A TUBO	21891
MANGUERA INFERIOR-MOTOR A RAD.	22877	TERMOSTATO-190°	33599
TERMOSTATO-190°	33599	2000	
2004		BANDA-VENT- OPCIONAL	9500
BANDA-VENT	K100502	BANDA-VENT	3/9500PB
POLEA DEL TENSOR-VENT	38076	MANGUERA SILICÓN-TUBO A RAD.	SIH250363C
TENSOR-VENT	38503	BANDA-TOMA DE FUERZA-ALT-AA	K080580
BANDA-TOMA DE FUERZA-ALT-AA	K080565	POLEA DEL TENSOR-TOMA DE FUERZA-ALT-AA	38075
POLEA DEL TENSOR-TOMA DE FUERZA-ALT-AA	38075	TENSOR-TOMA DE FUERZA-ALT-AA	38501
TENSOR-TOMA DE FUERZA-ALT-AA	38501	MANGUERA SILICÓN-MOTOR A TUBO	SIH250363C
MANGUERA SILICÓN-RAD. A TUBO	SIH250363C	MANGUERA SUPERIOR-MOTOR A TUBO	21891
MANGUERA SILICÓN-MOTOR A TUBO	SIH250363C	TERMOSTATO-190°	33599
MANGUERA INFERIOR-MOTOR A RAD.	22877	1999	
TERMOSTATO-190°	33599	BANDA-VENT- OPCIONAL	9500
2003		BANDA-VENT	3/9500PB
BANDA-VENT- OPCIONAL	9500	BANDA-VENT	9510
BANDA-VENT	3/9500PB	BANDA-VENT	K100502
MANGUERA SILICÓN-TUBO A RAD.	SIH250363C	MANGUERA SILICÓN-TUBO A RAD.	SIH250363C
BANDA-TOMA DE FUERZA-ALT-AA	K080570	BANDA-TOMA DE FUERZA-ALT-AA	2/9510PB
POLEA DEL TENSOR-TOMA DE FUERZA-ALT-AA	38075	BANDA-TOMA DE FUERZA-ALT-AA	9510
TENSOR-TOMA DE FUERZA-ALT-AA	38501	BANDA-TOMA DE FUERZA-ALT-AA	K080580
MANGUERA SILICÓN-MOTOR A TUBO	SIH250363C	POLEA DEL TENSOR-TOMA DE FUERZA-ALT-AA	38075
MANGUERA SUPERIOR-MOTOR A TUBO	21891	TENSOR-TOMA DE FUERZA-ALT-AA	38501
TERMOSTATO-190°	33599	MANGUERA SILICÓN-MOTOR A TUBO	SIH250363C
2002		MANGUERA SUPERIOR-MOTOR A TUBO	21891
BANDA-VENT- OPCIONAL	9500	TERMOSTATO-190°	33599
BANDA-VENT	3/9500PB	1998	
MANGUERA SILICÓN-TUBO A RAD.	SIH250363C	BANDA-VENT- OPCIONAL	9500
BANDA-TOMA DE FUERZA-ALT-AA	K080570	BANDA-VENT	3/9500PB
POLEA DEL TENSOR-TOMA DE FUERZA-ALT-AA	38075	BANDA-VENT	9510
TENSOR-TOMA DE FUERZA-ALT-AA	38501	MANGUERA INFERIOR-TUBO A RAD.	21472
MANGUERA SILICÓN-MOTOR A TUBO	SIH250363C	MANGUERA SILICÓN-TUBO A RAD.	SIH250363C
MANGUERA SUPERIOR-MOTOR A TUBO	21891	BANDA-TOMA DE FUERZA-ALT-AA	9510
TERMOSTATO-190°	33599	MANGUERA SILICÓN-MOTOR A TUBO	SIH250363C
2001		MANGUERA SUPERIOR-MOTOR A TUBO	21891
BANDA-VENT- OPCIONAL	9500	MANGUERA SILICÓN-ENTRADA A BA	SIH300363C
BANDA-VENT	3/9500PB	BANDA-ALT-AA	2/9510PB



MASTER SERVICIO PESADO 2014

FREIGHTLINER

CENTURY CLASS

TERMOSTATO-190°	33599	TERMOSTATO-190°	33599
MANGUERA DE AGUA-	30T 3/4"	2000	
MANGUERA DE AGUA-	30T 5/8"	BANDA-VENT- OPCIONAL	9500
MANGUERA DE PASO-	CHARTER 1 3/4"	BANDA-VENT	3/9500PB
1997		MANGUERA SILICÓN-TUBO A RAD.	SIH250363C
BANDA-VENT- OPCIONAL	9500	BANDA-TOMA DE FUERZA-ALT-AA	K080580
BANDA-VENT	3/9500PB	POLEA DEL TENSOR-TOMA DE FUERZA-ALT-AA	38075
BANDA-VENT	9510	TENSOR-TOMA DE FUERZA-ALT-AA	38501
BANDA-ALT-AA	2/9510PB	MANGUERA SILICÓN-MOTOR A TUBO	SIH250363C
TERMOSTATO-190°	33599	MANGUERA SUPERIOR-MOTOR A TUBO	21891
1996		TERMOSTATO-190°	33599
TERMOSTATO-190°	33599	1999	
DETROIT DIESEL 6 CIL, 11.1 L DIESEL		BANDA-VENT- OPCIONAL	9500
2003		BANDA-VENT	3/9500PB
BANDA-VENT- OPCIONAL	9500	BANDA-VENT	9510
BANDA-VENT	3/9500PB	BANDA-VENT	K100502
MANGUERA SILICÓN-TUBO A RAD.	SIH250363C	MANGUERA SILICÓN-TUBO A RAD.	SIH250363C
BANDA-TOMA DE FUERZA-ALT-AA	K080570	BANDA-TOMA DE FUERZA-ALT-AA	2/9510PB
POLEA DEL TENSOR-TOMA DE FUERZA-ALT-AA	38075	BANDA-TOMA DE FUERZA-ALT-AA	9510
TENSOR-TOMA DE FUERZA-ALT-AA	38501	BANDA-TOMA DE FUERZA-ALT-AA	K080580
MANGUERA SILICÓN-MOTOR A TUBO	SIH250363C	POLEA DEL TENSOR-TOMA DE FUERZA-ALT-AA	38075
MANGUERA SUPERIOR-MOTOR A TUBO	21891	TENSOR-TOMA DE FUERZA-ALT-AA	38501
TERMOSTATO-190°	33599	MANGUERA SILICÓN-MOTOR A TUBO	SIH250363C
2002		MANGUERA SUPERIOR-MOTOR A TUBO	21891
BANDA-VENT- OPCIONAL	9500	TERMOSTATO-190°	33599
BANDA-VENT	3/9500PB	1998	
MANGUERA SILICÓN-TUBO A RAD.	SIH250363C	BANDA-VENT- OPCIONAL	9500
BANDA-TOMA DE FUERZA-ALT-AA	K080570	BANDA-VENT	3/9500PB
POLEA DEL TENSOR-TOMA DE FUERZA-ALT-AA	38075	BANDA-VENT	9510
TENSOR-TOMA DE FUERZA-ALT-AA	38501	MANGUERA INFERIOR-TUBO A RAD.	21472
MANGUERA SILICÓN-MOTOR A TUBO	SIH250363C	MANGUERA SILICÓN-TUBO A RAD.	SIH250363C
MANGUERA SUPERIOR-MOTOR A TUBO	21891	BANDA-TOMA DE FUERZA-ALT-AA	9510
TERMOSTATO-190°	33599	MANGUERA SILICÓN-MOTOR A TUBO	SIH250363C
2001		MANGUERA SUPERIOR-MOTOR A TUBO	21891
BANDA-VENT- OPCIONAL	9500	MANGUERA SILICÓN-ENTRADA A BA	SIH300363C
BANDA-VENT	3/9500PB	BANDA-ALT-AA	2/9510PB
MANGUERA SILICÓN-TUBO A RAD.	SIH250363C	TERMOSTATO-190°	33599
BANDA-TOMA DE FUERZA-ALT-AA C/ALT 135A	K080565	MANGUERA DE AGUA-	30T 3/4"
BANDA-TOMA DE FUERZA-ALT-AA C/130 A	K080570	MANGUERA DE AGUA-	30T 5/8"
POLEA DEL TENSOR-TOMA DE FUERZA-ALT-AA	38075	MANGUERA DE PASO-	CHARTER 1 3/4"
TENSOR-TOMA DE FUERZA-ALT-AA	38501	1997	
MANGUERA SILICÓN-MOTOR A TUBO	SIH250363C	BANDA-VENT- OPCIONAL	9500
MANGUERA SUPERIOR-MOTOR A TUBO	21891	BANDA-VENT	3/9500PB



MASTER SERVICIO PESADO 2014

FREIGHTLINER

CENTURY CLASS

BANDA-VENT	9510	MANGUERA SILICÓN-MOTOR A TUBO	SIH250363C
BANDA-ALT-AA	2/9510PB	MANGUERA SUPERIOR-MOTOR A TUBO	CHARTER 2 1/2"
TERMOSTATO-190°	33599	BANDA-ALT	9451
1996		BANDA-ALT	PQ17450
TERMOSTATO-190°	33599	TERMOSTATO-190°	33579
CUMMINS N14 DIESEL		TERMOSTATO-180°	33576
2003		TERMOSTATO-180°	33578
TERMOSTATO-190°	33579	TERMOSTATO-170°	33577
TERMOSTATO-180°	33576	MANGUERA INFERIOR-	CHARTER 2 1/2"
TERMOSTATO-180°	33578	1999	
TERMOSTATO-170°	33577	MANGUERA SILICÓN-TUBO A RAD.	SIH250363C
2002		MANGUERA SUPERIOR-TUBO A RAD.	CHARTER 2 1/2"
TERMOSTATO-190°	33579	BANDA-TOMA DE FUERZA-VENT	2/TR28411PB
TERMOSTATO-180°	33576	BANDA-TOMA DE FUERZA-VENT	PQ28412
TERMOSTATO-180°	33578	BANDA-TOMA DE FUERZA-VENT	TR28412
TERMOSTATO-170°	33577	BANDA-TOMA DE FUERZA-BA	K060425
2001		BANDA-TOMA DE FUERZA-AA	9435
MANGUERA SILICÓN-TUBO A RAD.	SIH250363C	BANDA-TOMA DE FUERZA-AA	PQ17440
MANGUERA SUPERIOR-TUBO A RAD.	CHARTER 2 1/2"	MANGUERA SILICÓN-MOTOR A TUBO	SIH250363C
BANDA-TOMA DE FUERZA-VENT	2/TR28411PB	MANGUERA SUPERIOR-MOTOR A TUBO	CHARTER 2 1/2"
BANDA-TOMA DE FUERZA-VENT	PQ28412	BANDA-ALT	9451
BANDA-TOMA DE FUERZA-VENT	TR28412	BANDA-ALT	PQ17450
BANDA-TOMA DE FUERZA-BA	K060425	TERMOSTATO-190°	33579
BANDA-TOMA DE FUERZA-AA	9435	TERMOSTATO-180°	33576
BANDA-TOMA DE FUERZA-AA	PQ17440	TERMOSTATO-180°	33578
MANGUERA SILICÓN-MOTOR A TUBO	SIH250363C	TERMOSTATO-170°	33577
MANGUERA SUPERIOR-MOTOR A TUBO	CHARTER 2 1/2"	MANGUERA INFERIOR-	CHARTER 2 1/2"
BANDA-ALT	9451	1998	
BANDA-ALT	PQ17450	BANDA-VENT	PQ28412
TERMOSTATO-190°	33579	BANDA-VENT	TR28412
TERMOSTATO-180°	33576	MANGUERA SILICÓN-TUBO A RAD.	SIH250363C
TERMOSTATO-180°	33578	MANGUERA SUPERIOR-TUBO A RAD.	CHARTER 2 1/2"
TERMOSTATO-170°	33577	BANDA-TOMA DE FUERZA-VENT	2/TR28411PB
MANGUERA INFERIOR-	CHARTER 2 1/2"	BANDA-TOMA DE FUERZA-VENT	PQ28412
2000		BANDA-TOMA DE FUERZA-VENT	TR28412
MANGUERA SILICÓN-TUBO A RAD.	SIH250363C	BANDA-TOMA DE FUERZA-BA	K060425
MANGUERA SUPERIOR-TUBO A RAD.	CHARTER 2 1/2"	BANDA-TOMA DE FUERZA-AA	PQ17440
BANDA-TOMA DE FUERZA-VENT	2/TR28411PB	MANGUERA SILICÓN-MOTOR A TUBO	SIH250363C
BANDA-TOMA DE FUERZA-VENT	PQ28412	MANGUERA SUPERIOR-MOTOR A TUBO	CHARTER 2 1/2"
BANDA-TOMA DE FUERZA-VENT	TR28412	BANDA-BA	K060425
BANDA-TOMA DE FUERZA-BA	K060425	BANDA-ALT	2/9451PB
BANDA-TOMA DE FUERZA-AA	9435	BANDA-ALT	9451
BANDA-TOMA DE FUERZA-AA	PQ17440		



MASTER SERVICIO PESADO 2014

FREIGHTLINER

CENTURY CLASS

BANDA-ALT	PQ17450	2000	
BANDA-AA	2/9435PB	MANGUERA SUPERIOR-TUBO A RAD.	CHARTER 2 1/2"
BANDA-AA	PQ17440	BANDA-TOMA DE FUERZA-AA	K060559
TERMOSTATO-190°	33579	MANGUERA SUPERIOR-MOTOR A TUBO	CHARTER 2 1/4"
TERMOSTATO-180°	33576	BANDA-ALT-VENT	K080730
TERMOSTATO-180°	33578	MANGUERA INFERIOR-	CHARTER 2 1/2"
TERMOSTATO-170°	33577	1999	
BANDA-	2/9435PB	BANDA-VENT	K080530
BANDA-	9435	MANGUERA SUPERIOR-TUBO A RAD.	CHARTER 2 1/2"
MANGUERA INFERIOR-	CHARTER 2 1/2"	BANDA-TOMA DE FUERZA-ALT	K050345
1997		BANDA-TOMA DE FUERZA-AA	K060559
BANDA-VENT	PQ28412	BANDA-TOMA DE FUERZA-AA	K080537
BANDA-TOMA DE FUERZA-VENT	PQ28429	MANGUERA SUPERIOR-MOTOR A TUBO	CHARTER 2 1/2"
BANDA-TOMA DE FUERZA-VENT	TR28429	BANDA-ALT	K050345
BANDA-BA	K060425	MANGUERA DE PASO-	CHARTER 1 3/4"
BANDA-ALT	2/9451PB	MANGUERA INFERIOR-	CHARTER 2 1/2"
BANDA-ALT	9451	1998	
BANDA-ALT	PQ17450	BANDA-VENT	K080496
BANDA-AA	2/9435PB	MANGUERA SUPERIOR-TUBO A RAD.	CHARTER 2 1/2"
BANDA-AA	PQ17440	MANGUERA SUPERIOR-MOTOR A TUBO	CHARTER 2 1/4"
TERMOSTATO-190°	33579	BANDA-ALT	K050345
TERMOSTATO-180°	33576	BANDA-AA	PQ17550
TERMOSTATO-180°	33578	MANGUERA DE PASO-	CHARTER 1 3/4"
TERMOSTATO-170°	33577	MANGUERA INFERIOR-	CHARTER 2 1/2"
BANDA-	2/9435PB	1997	
BANDA-	9435	BANDA-VENT	K080491
1996		BANDA-VENT	K080496
BANDA-VENT	PQ28412	MANGUERA SILICÓN-TUBO A RAD.	SIH250363C
BANDA-TOMA DE FUERZA-VENT	2/TR28411PB	MANGUERA SUPERIOR-TUBO A RAD.	CHARTER 2 1/2"
BANDA-TOMA DE FUERZA-VENT	TR28412	MANGUERA SUPERIOR-MOTOR A TUBO	24436
BANDA-BA	K060425	MANGUERA SUPERIOR-MOTOR A TUBO	CHARTER 2 1/4"
BANDA-ALT	2/9451PB	BANDA-ALT	K050345
BANDA-ALT	9451	BANDA-AA	PQ17550
BANDA-ALT	PQ17450	TERMOSTATO-190°	33579
BANDA-AA	2/9435PB	TERMOSTATO-180°	33576
BANDA-AA	PQ17440	TERMOSTATO-180°	33578
TERMOSTATO-190°	33579	TERMOSTATO-170°	33577
TERMOSTATO-180°	33576	BANDA-	9545
TERMOSTATO-180°	33578	MANGUERA DE PASO-	CHARTER 1 3/4"
TERMOSTATO-170°	33577	MANGUERA INFERIOR-	CHARTER 2 1/2"
BANDA-	2/9435PB	MANGUERA SILICÓN-	SIH250363C
BANDA-	9435	1996	
		BANDA-VENT	K080496

CUMMINS M11 DIESEL



MASTER SERVICIO PESADO 2014

FREIGHTLINER

CENTURY CLASS

MANGUERA SILICÓN-TUBO A RAD.	SIH250363C	BANDA-ALT-VENT	K080730
MANGUERA SUPERIOR-TUBO A RAD.	CHARTER 2 1/2"	TENSOR-ALT-VENT	38521
MANGUERA SUPERIOR-MOTOR A TUBO	24436	POLEA DEL TENSOR-	36091
MANGUERA SUPERIOR-MOTOR A TUBO	CHARTER 2 1/4"	2000	
BANDA-ALT	K050345	MANGUERA SILICÓN-TUBO A RAD.	SIH250363C
BANDA-AA	PQ17550	BANDA-TOMA DE FUERZA-AA	K060560
TERMOSTATO-190°	33579	TENSOR-TOMA DE FUERZA-AA	38505
TERMOSTATO-180°	33576	MANGUERA SILICÓN-MOTOR A TUBO	SIH250363C
TERMOSTATO-180°	33578	MANGUERA SUPERIOR-MOTOR A TUBO	24436
TERMOSTATO-170°	33577	BANDA-ALT-VENT	K080730
BANDA-	9545	TENSOR-ALT-VENT	38521
MANGUERA DE PASO-	CHARTER 1 3/4"	POLEA DEL TENSOR-	36091
MANGUERA INFERIOR-	CHARTER 2 1/2"	1999	
MANGUERA SILICÓN-	SIH250363C	BANDA-VENT	K080530
CUMMINS ISX DIESEL			
2001			
MANGUERA INFERIOR-TUBO A RAD.	21891	MANGUERA SILICÓN-TUBO A RAD.	SIH250363C
MANGUERA SILICÓN-TUBO A RAD.	SIH250363C	BANDA-TOMA DE FUERZA-ALT	K050345
BANDA-TOMA DE FUERZA-VENT	K100710	BANDA-TOMA DE FUERZA-AA	K060560
POLEA DEL TENSOR-TOMA DE FUERZA-VENT	36092	BANDA-TOMA DE FUERZA-AA	K080537
TENSOR-TOMA DE FUERZA-VENT	38535	TENSOR-TOMA DE FUERZA-AA	38505
BANDA-TOMA DE FUERZA-ALT-AA	K060685	MANGUERA SILICÓN-MOTOR A TUBO	SIH250363C
POLEA DEL TENSOR-TOMA DE FUERZA-ALT-AA	36095	BANDA-ALT-VENT	K080730
TENSOR-TOMA DE FUERZA-ALT-AA	38532	TENSOR-ALT-VENT	38521
MANGUERA SILICÓN-MOTOR A TUBO	SIH250363C	MANGUERA DE PASO-	CHARTER 1 3/4"
2000			
BANDA-VENT	K100710	POLEA DEL TENSOR-	36091
POLEA DEL TENSOR-VENT	36092	1998	
TENSOR-VENT	38535	BANDA-VENT	K080491
MANGUERA SILICÓN-TUBO A RAD.	SIH250363C	MANGUERA SILICÓN-TUBO A RAD.	SIH250363C
BANDA-TOMA DE FUERZA-ALT-AA	K060685	MANGUERA SUPERIOR-MOTOR A TUBO	24436
POLEA DEL TENSOR-TOMA DE FUERZA-ALT-AA	36095	BANDA-ALT-VENT	K080730
TENSOR-TOMA DE FUERZA-ALT-AA	38532	TENSOR-ALT-VENT	38521
MANGUERA INFERIOR-MOTOR A TUBO	21135	BANDA-ALT	K050345
MANGUERA SILICÓN-MOTOR A TUBO	SIH250363C	BANDA-AA	K060560
CUMMINS ISM DIESEL			
2001			
MANGUERA INFERIOR-TUBO A RAD.	21891	TENSOR-AA	38507
MANGUERA SUPERIOR-TUBO A RAD.	CHARTER 2 1/2"	BANDA-	9545
BANDA-TOMA DE FUERZA-AA	K060559	MANGUERA DE PASO-	CHARTER 1 3/4"
TENSOR-TOMA DE FUERZA-AA	38505	MANGUERA SILICÓN-	SIH250363C
MANGUERA INFERIOR-MOTOR A TUBO	CHARTER 2 1/2"	POLEA DEL TENSOR-	36091
MANGUERA SUPERIOR-MOTOR A TUBO	CHARTER 2 1/4"	CATERPILLAR C16 DIESEL	
2008			
		TERMOSTATO-190°	33579
		TERMOSTATO-180°	33576
		TERMOSTATO-180°	33578
		TERMOSTATO-170°	33577



MASTER SERVICIO PESADO 2014

FREIGHTLINER

CENTURY CLASS

2007		POLEA-MOTOR	36093
TERMOSTATO-190°	33579	BANDA-ALT-VENT	K080926
TERMOSTATO-180°	33576	TENSOR-ALT-VENT	38569
TERMOSTATO-180°	33578	TERMOSTATO-190°	33579
TERMOSTATO-170°	33577	TERMOSTATO-180°	33576
CATERPILLAR C15 DIESEL		TERMOSTATO-180°	33578
2008		TERMOSTATO-170°	33577
TERMOSTATO-190°	33579	2004	
TERMOSTATO-180°	33576	BANDA-VENT-AA	K060598
TERMOSTATO-180°	33578	POLEA DEL TENSOR-VENT-AA	36091
TERMOSTATO-170°	33577	TENSOR-VENT-AA	38508
2007		MANGUERA SILICÓN-TUBO A RAD.	SIH250363C
POLEA-MOTOR	36091	MANGUERA SILICÓN-TUBO A RAD.	SIH300363C
POLEA-MOTOR	36093	MANGUERA SILICÓN-MOTOR A TUBO	SIH250363C
TERMOSTATO-190°	33579	MANGUERA SILICÓN-MOTOR A TUBO	SIH300363C
TERMOSTATO-180°	33576	POLEA-MOTOR	36091
TERMOSTATO-180°	33578	POLEA-MOTOR	36093
TERMOSTATO-170°	33577	BANDA-ALT-VENT	K080952
2006		POLEA-ALT-VENT	36091
BANDA-VENT-AA	K060635	TENSOR-ALT-VENT	38506
POLEA DEL TENSOR-VENT-AA	36091	TERMOSTATO-190°	33579
TENSOR-VENT-AA	38511	TERMOSTATO-180°	33576
MANGUERA SILICÓN-RAD. A TUBO	SIH250363C	TERMOSTATO-180°	33578
MANGUERA SUPERIOR-RAD. A TUBO	21891	TERMOSTATO-170°	33577
MANGUERA SILICÓN-MOTOR A TUBO	SIH250363C	2003	
MANGUERA SILICÓN-MOTOR A RAD.	SIH250363C	BANDA-VENT-AA	K060598
POLEA-MOTOR	36091	POLEA DEL TENSOR-VENT-AA	36091
POLEA-MOTOR	36093	TENSOR-VENT-AA	38508
BANDA-ALT-VENT	K080926	MANGUERA SILICÓN-TUBO A RAD.	SIH250363C
TENSOR-ALT-VENT	38569	MANGUERA SILICÓN-TUBO A RAD.	SIH300363C
TERMOSTATO-190°	33579	MANGUERA SILICÓN-MOTOR A TUBO	SIH250363C
TERMOSTATO-180°	33576	MANGUERA SILICÓN-MOTOR A TUBO	SIH300363C
TERMOSTATO-180°	33578	BANDA-ALT-VENT	K080952
TERMOSTATO-170°	33577	POLEA-ALT-VENT	36091
2005		TENSOR-ALT-VENT	38506
BANDA-VENT-AA	K060635	TERMOSTATO-190°	33579
POLEA DEL TENSOR-VENT-AA	36091	TERMOSTATO-180°	33576
TENSOR-VENT-AA	38511	TERMOSTATO-180°	33578
MANGUERA SILICÓN-RAD. A TUBO	SIH250363C	TERMOSTATO-170°	33577
MANGUERA SUPERIOR-RAD. A TUBO	21891	2002	
MANGUERA SILICÓN-MOTOR A TUBO	SIH250363C	BANDA-VENT-AA	K060598
MANGUERA SILICÓN-MOTOR A RAD.	SIH250363C	POLEA DEL TENSOR-VENT-AA	36091
POLEA-MOTOR	36091	TENSOR-VENT-AA	38508

TRANSPORTE



Soluciones Confiables

NUEVO

A TODA NUESTRA RED DE DISTRIBUCIÓN
NUEVAS MANGUERAS CH's
 PARA SERVICIO PESADO



Mercedes-Benz



Tenemos el gusto de informarles que continuamos integrando nuevos números de Mangueras CH's, en esta ocasión son 9 números que aplican para **Autobuses Urbanos de la Marca Mercedes Benz para Motores OM904, OM906 y OM924** con un considerable parque vehicular en circulación en las principales ciudades del País.

NOTA: Estas Mangueras aplican para Modelos **BOXER, BOXER OF, TORINO, ZAFIRO** con las carrocerías de mayor prestigio en México como RECO, AYCO, OPERBUS, BECCAR, NOVACAPRE, EUROCAR, MARCOPOLO, CATOSA, etc. A partir de año 2001.

Actualmente estas Mangueras sólo están disponibles en la Agencia, por lo que existe una gran oportunidad de penetrar al mercado, siendo un factor de éxito la velocidad de integración a su inventario.

OEM	GATES	APLICACIÓN Y POSICIÓN
LM6855011584	CH-170022	De T metálica al Radiador Motor OM904
LM6855011984	CH-170033	De T metálica a la Bomba de Agua Motor OM904
A0521321000	CH-170043	Manguera de recuperador de T de paso Motor OM904
A685501582	CH-170002	Manguera Inferior de Radiador Motor OM906
A0520539000	CH-170013	Del Recuperador a la Bomba de Agua Motor OM906
A0520553000	CH-170031	Del Motor al Radiador [Superior] Motor OM906
A6855013882	CH-170003	Manguera de Motor a Radiador [Superior] Motor OM924
A6855289482	CH-170333	Manguera de Motor a Cabeza [anticongelante] Motor OM924
A6855012882	CH-170023	Manguera de Motor de Paso [anticongelante] Motor OM924

Para cualquier duda o comentario, favor de comunicarte al **2000-2788**, a la dirección electrónica cg1232@gates.com o con su Gerente Regional de Ventas.

Gerente de Línea FPA



CH-170022



CH-170033



CH-170043



CH-170002



CH-170013



CH-170031



CH-170003



CH-170333



CH-170023

www.Gates.com.mx



MASTER SERVICIO PESADO 2014

FREIGHTLINER

CENTURY CLASS

MANGUERA SILICÓN-TUBO A RAD.	SIH250363C	BANDA-ALT-VENT-AA	K081005
MANGUERA SILICÓN-TUBO A RAD.	SIH300363C	TENSOR-ALT-VENT-AA	38590
MANGUERA SILICÓN-MOTOR A TUBO	SIH250363C	TERMOSTATO-190°	33579
MANGUERA SILICÓN-MOTOR A TUBO	SIH300363C	TERMOSTATO-180°	33576
BANDA-ALT-VENT	K080952	TERMOSTATO-180°	33578
POLEA-ALT-VENT	36091	TERMOSTATO-170°	33577
TENSOR-ALT-VENT	38506	2005	
TERMOSTATO-190°	33579	POLEA-MOTOR	36093
TERMOSTATO-180°	33576	TERMOSTATO-190°	33579
TERMOSTATO-180°	33578	TERMOSTATO-180°	33576
TERMOSTATO-170°	33577	TERMOSTATO-180°	33578
2001		TERMOSTATO-170°	33577
BANDA-VENT-AA	K060598	2004	
POLEA DEL TENSOR-VENT-AA	36091	POLEA-MOTOR	36093
TENSOR-VENT-AA	38508	TERMOSTATO-190°	33579
MANGUERA SILICÓN-TUBO A RAD.	SIH250363C	TERMOSTATO-180°	33576
MANGUERA SILICÓN-TUBO A RAD.	SIH300363C	TERMOSTATO-180°	33578
MANGUERA SILICÓN-MOTOR A TUBO	SIH250363C	TERMOSTATO-170°	33577
MANGUERA SILICÓN-MOTOR A TUBO	SIH300363C	CATERPILLAR C12 DIESEL	
BANDA-ALT-VENT	K080952	2004	
POLEA-ALT-VENT	36091	BANDA-VENT-AA	K060480
TENSOR-ALT-VENT	38506	POLEA DEL TENSOR-VENT-AA	36091
TERMOSTATO-190°	33579	TENSOR-VENT-AA	38524
TERMOSTATO-180°	33576	BANDA-ALT-VENT	K080922
TERMOSTATO-180°	33578	POLEA-ALT-VENT	36091
TERMOSTATO-170°	33577	TENSOR-ALT-VENT	38506
CATERPILLAR C13 DIESEL		TERMOSTATO-190°	33579
2008		TERMOSTATO-180°	33576
TERMOSTATO-190°	33579	TERMOSTATO-180°	33578
TERMOSTATO-180°	33576	TERMOSTATO-170°	33577
TERMOSTATO-180°	33578	2003	
TERMOSTATO-170°	33577	BANDA-VENT-AA	K060480
2007		POLEA DEL TENSOR-VENT-AA	36091
POLEA-MOTOR	36093	TENSOR-VENT-AA	38524
TERMOSTATO-190°	33579	BANDA-ALT-VENT	K080922
TERMOSTATO-180°	33576	POLEA-ALT-VENT	36091
TERMOSTATO-180°	33578	TENSOR-ALT-VENT	38506
TERMOSTATO-170°	33577	TERMOSTATO-190°	33579
2006		TERMOSTATO-180°	33576
MANGUERA INFERIOR-RAD. A TUBO	21135	TERMOSTATO-180°	33578
MANGUERA SILICÓN-RAD. A TUBO	SIH250363C	TERMOSTATO-170°	33577
MANGUERA SILICÓN-MOTOR A TUBO	SIH250363C	2002	
POLEA-MOTOR	36093	BANDA-VENT-AA	K060529



MASTER SERVICIO PESADO 2014

FREIGHTLINER

CENTURY CLASS

POLEA DEL TENSOR-VENT-AA	36091	TERMOSTATO-170°	33577
TENSOR-VENT-AA	38524	1998	
BANDA-ALT-VENT	K080780	BANDA-ALT-VENT	K080922
POLEA-ALT-VENT	36091	POLEA-ALT-VENT	36091
TENSOR-ALT-VENT	38506	TENSOR-ALT-VENT	38505
TERMOSTATO-190°	33579	BANDA-AA	K060480
TERMOSTATO-180°	33576	BANDA-AA	K060523
TERMOSTATO-180°	33578	TERMOSTATO-190°	33579
TERMOSTATO-170°	33577	TERMOSTATO-180°	33576
2001		TERMOSTATO-180°	33578
BANDA-VENT-AA	K060523	TERMOSTATO-170°	33577
POLEA DEL TENSOR-VENT-AA	36091	1997	
TENSOR-VENT-AA	38524	MANGUERA SUPERIOR-TUBO A RAD.	21891
BANDA-ALT-VENT	K080855	BANDA-ALT-VENT	K080680
POLEA-ALT-VENT	36091	TERMOSTATO-190°	33579
TENSOR-ALT-VENT	38506	TERMOSTATO-180°	33576
TERMOSTATO-190°	33579	TERMOSTATO-180°	33578
TERMOSTATO-180°	33576	TERMOSTATO-170°	33577
TERMOSTATO-180°	33578	BANDA-	9530
TERMOSTATO-170°	33577	1996	
2000		MANGUERA INFERIOR-TUBO A RAD.	21891
BANDA-VENT-AA	K060523	BANDA-AA	PQ17530
TENSOR-VENT-AA	38534	TERMOSTATO-175°	33549
BANDA-TOMA DE FUERZA-ALT-VENT	K080855	CATERPILLAR C11 DIESEL	
POLEA DEL TENSOR-TOMA DE FUERZA-ALT-VENT	36091	2006	
TENSOR-TOMA DE FUERZA-ALT-VENT	38506	MANGUERA INFERIOR-RAD. A TUBO	21135
POLEA-ALT-VENT	36091	MANGUERA SILICÓN-RAD. A TUBO	SIH250363C
POLEA DEL TENSOR-ALT-AA	38092	MANGUERA SILICÓN-MOTOR A TUBO	SIH250363C
TERMOSTATO-190°	33579	POLEA-MOTOR	36093
TERMOSTATO-180°	33576	BANDA-ALT-VENT-AA	K081005
TERMOSTATO-180°	33578	TENSOR-ALT-VENT-AA	38590
TERMOSTATO-170°	33577	TERMOSTATO-190°	33579
1999		TERMOSTATO-180°	33576
TENSOR-VENT-AA	38534	TERMOSTATO-180°	33578
BANDA-ALT-VENT	K080922	TERMOSTATO-170°	33577
POLEA-ALT-VENT	36091	2005	
TENSOR-ALT-VENT	38506	POLEA-MOTOR	36093
POLEA DEL TENSOR-ALT-AA	38092	TERMOSTATO-190°	33579
BANDA-AA	K060480	TERMOSTATO-180°	33576
BANDA-AA	K060523	TERMOSTATO-180°	33578
TERMOSTATO-190°	33579	TERMOSTATO-170°	33577
TERMOSTATO-180°	33576	2004	
TERMOSTATO-180°	33578	POLEA-MOTOR	36093



MASTER SERVICIO PESADO 2014

FREIGHTLINER

CENTURY CLASS

TERMOSTATO-190°	33579	TENSOR-TOMA DE FUERZA-ALT-VENT	38506
TERMOSTATO-180°	33576	POLEA-ALT-VENT	36091
TERMOSTATO-180°	33578	POLEA DEL TENSOR-ALT-AA	38092
TERMOSTATO-170°	33577	TERMOSTATO-190°	33579
CATERPILLAR C10 DIESEL		TERMOSTATO-180°	33576
2003		TERMOSTATO-180°	33578
BANDA-VENT-AA	K060480	TERMOSTATO-170°	33577
POLEA DEL TENSOR-VENT-AA	36091	1999	
TENSOR-VENT-AA	38524	TENSOR-VENT-AA	38534
BANDA-ALT-VENT	K080922	BANDA-ALT-VENT	K080922
POLEA-ALT-VENT	36091	POLEA-ALT-VENT	36091
TENSOR-ALT-VENT	38506	TENSOR-ALT-VENT	38506
TERMOSTATO-190°	33579	POLEA DEL TENSOR-ALT-AA	38092
TERMOSTATO-180°	33576	BANDA-AA	K060480
TERMOSTATO-180°	33578	BANDA-AA	K060523
TERMOSTATO-170°	33577	TERMOSTATO-190°	33579
2002		TERMOSTATO-180°	33576
BANDA-VENT-AA	K060529	TERMOSTATO-180°	33578
POLEA DEL TENSOR-VENT-AA	36091	TERMOSTATO-170°	33577
TENSOR-VENT-AA	38524	1998	
BANDA-ALT-VENT	K080780	BANDA-ALT-VENT	K080922
POLEA-ALT-VENT	36091	POLEA-ALT-VENT	36091
TENSOR-ALT-VENT	38506	TENSOR-ALT-VENT	38506
TERMOSTATO-190°	33579	BANDA-AA	K060480
TERMOSTATO-180°	33576	BANDA-AA	K060523
TERMOSTATO-180°	33578	TERMOSTATO-190°	33579
TERMOSTATO-170°	33577	TERMOSTATO-180°	33576
2001		TERMOSTATO-180°	33578
BANDA-VENT-AA	K060523	TERMOSTATO-170°	33577
POLEA DEL TENSOR-VENT-AA	36091	1997	
TENSOR-VENT-AA	38524	MANGUERA SUPERIOR-TUBO A RAD.	21891
BANDA-ALT-VENT	K080855	BANDA-ALT-VENT	K080680
POLEA-ALT-VENT	36091	TERMOSTATO-190°	33579
TENSOR-ALT-VENT	38506	TERMOSTATO-180°	33576
TERMOSTATO-190°	33579	TERMOSTATO-180°	33578
TERMOSTATO-180°	33576	TERMOSTATO-170°	33577
TERMOSTATO-180°	33578	BANDA-	9530
TERMOSTATO-170°	33577	1996	
2000		MANGUERA SUPERIOR-TUBO A RAD.	21891
BANDA-VENT-AA	K060523	TERMOSTATO-190°	33579
TENSOR-VENT-AA	38534	TERMOSTATO-180°	33576
BANDA-TOMA DE FUERZA-ALT-VENT	K080855	TERMOSTATO-180°	33578
POLEA DEL TENSOR-TOMA DE FUERZA-ALT-VENT	36091	TERMOSTATO-170°	33577



MASTER SERVICIO PESADO 2014

FREIGHTLINER

CENTURY CLASS

BANDA-	9530	TERMOSTATO-190°	33579
CATERPILLAR 3406 DIESEL		TERMOSTATO-180°	33576
2002		TERMOSTATO-180°	33578
TERMOSTATO-190°	33579	TERMOSTATO-170°	33577
TERMOSTATO-180°	33576	1997	
TERMOSTATO-180°	33578	BANDA-VENT	9505
TERMOSTATO-170°	33577	MANGUERA SILICÓN-TUBO A RAD.	SIH250363C
2001		MANGUERA SILICÓN-MOTOR A TUBO	SIH250363C
TERMOSTATO-190°	33579	MANGUERA SILICÓN-MOTOR A TUBO	SIH300363C
TERMOSTATO-180°	33576	BANDA-ALT-AA	9600
TERMOSTATO-180°	33578	TERMOSTATO-190°	33579
TERMOSTATO-170°	33577	TERMOSTATO-180°	33576
2000		TERMOSTATO-180°	33578
TERMOSTATO-190°	33579	TERMOSTATO-170°	33577
TERMOSTATO-180°	33576	1996	
TERMOSTATO-180°	33578	BANDA-VENT	9505
TERMOSTATO-170°	33577	MANGUERA SILICÓN-TUBO A RAD.	SIH250363C
1999		MANGUERA SILICÓN-MOTOR A TUBO	SIH250363C
BANDA-VENT-AA	K060594	MANGUERA SILICÓN-MOTOR A TUBO	SIH300363C
POLEA DEL TENSOR-VENT-AA	36091	BANDA-ALT-AA	9600
TENSOR-VENT-AA	38508	TERMOSTATO-190°	33579
MANGUERA SILICÓN-TUBO A RAD.	SIH250363C	TERMOSTATO-180°	33576
MANGUERA SILICÓN-TUBO A RAD.	SIH300363C	TERMOSTATO-180°	33578
MANGUERA SILICÓN-MOTOR A TUBO	SIH250363C	TERMOSTATO-170°	33577
MANGUERA SILICÓN-MOTOR A TUBO	SIH300363C	CLASSIC	
BANDA-ALT-VENT	K080952	MERCEDES BENZ MBE 4000 Diesel	
POLEA-ALT-VENT	36091	2010	
TENSOR-ALT-VENT	38506	BANDA-VENT	K080505
TERMOSTATO-190°	33579	TENSOR-VENT	38597
TERMOSTATO-180°	33576	MANGUERA INFERIOR-TUBO A RAD.	24047
TERMOSTATO-180°	33578	MANGUERA SUPERIOR-TUBO A RAD.	21891
TERMOSTATO-170°	33577	MANGUERA INFERIOR-MOTOR A TUBO	26045
1998		MANGUERA SUPERIOR-MOTOR A TUBO	24440
BANDA-VENT-AA	K060594	BANDA-AA	K080855
POLEA DEL TENSOR-VENT-AA	36091	POLEA DEL TENSOR-AA	38075
TENSOR-VENT-AA	38508	TENSOR-AA	38501
MANGUERA SILICÓN-TUBO A RAD.	SIH250363C	2009	
MANGUERA SILICÓN-TUBO A RAD.	SIH300363C	BANDA-VENT	K080505
MANGUERA SILICÓN-MOTOR A TUBO	SIH250363C	TENSOR-VENT	38597
MANGUERA SILICÓN-MOTOR A TUBO	SIH300363C	MANGUERA INFERIOR-TUBO A RAD.	24047
BANDA-ALT-VENT	K080952	MANGUERA SUPERIOR-TUBO A RAD.	21891
POLEA-ALT-VENT	36091	MANGUERA INFERIOR-MOTOR A TUBO	26045
TENSOR-ALT-VENT	38506	MANGUERA SUPERIOR-MOTOR A TUBO	24440



MASTER SERVICIO PESADO 2014

FREIGHTLINER

CLASSIC

BANDA-AA	K080855	POLEA DEL TENSOR-TOMA DE FUERZA-ALT-AA	38075
POLEA DEL TENSOR-AA	38075	TENSOR-TOMA DE FUERZA-ALT-AA	38501
TENSOR-AA	38501	MANGUERA INFERIOR-RAD. A TUBO	21135
DETROIT DIESEL SERIE 60		MANGUERA SUPERIOR-RAD. A TUBO	21115
2005		MANGUERA SILICÓN-MOTOR A TUBO	SIH250363C
BANDA-VENT	K100579	TERMOSTATO-190°	33599
POLEA-VENT	38076	2005	
TENSOR-VENT	38503	BANDA-VENT	K100579
BANDA-TOMA DE FUERZA-ALT-AA	K080565	POLEA DEL TENSOR-VENT	38076
POLEA-TOMA DE FUERZA-ALT-AA	38075	TENSOR-VENT	38503
TENSOR-TOMA DE FUERZA-ALT-AA	38501	BANDA-TOMA DE FUERZA-ALT-AA	K080565
MANGUERA DE PASO-RAD. A TUBO	21135	POLEA DEL TENSOR-TOMA DE FUERZA-ALT-AA	38075
MANGUERA DE PASO-RAD. A TUBO	21150	TENSOR-TOMA DE FUERZA-ALT-AA	38501
MANGUERA SUPERIOR-MOTOR A TUBO	CHARTER 2 1/2"	MANGUERA INFERIOR-RAD. A TUBO	21135
MANGUERA INFERIOR-	CHARTER 2 1/2"	MANGUERA SUPERIOR-RAD. A TUBO	21115
DETROIT DIESEL 6 CIL, 14.0 L DIESEL		MANGUERA SILICÓN-MOTOR A TUBO	SIH250363C
2008		TERMOSTATO-190°	33599
BANDA-VENT	K100502	2004	
POLEA DEL TENSOR-VENT	38076	BANDA-VENT- OPCIONAL	9525
TENSOR-VENT	38503	BANDA-VENT	3/9525PB
BANDA-TOMA DE FUERZA-ALT-AA	K080570	BANDA-VENT	K100579
POLEA DEL TENSOR-TOMA DE FUERZA-ALT-AA	38075	MANGUERA SILICÓN-TUBO A RAD.	SIH250363C
TENSOR-TOMA DE FUERZA-ALT-AA	38501	BANDA-TOMA DE FUERZA-ALT-AA	K080570
MANGUERA INFERIOR-RAD. A TUBO	21891	POLEA DEL TENSOR-TOMA DE FUERZA-ALT-AA	38075
MANGUERA SILICÓN-RAD. A TUBO	SIH250363C	TENSOR-TOMA DE FUERZA-ALT-AA	38501
MANGUERA SILICÓN-MOTOR A TUBO	SIH250363C	MANGUERA SILICÓN-MOTOR A TUBO	SIH250363C
TERMOSTATO-190°	33599	TERMOSTATO-190°	33599
2007		2003	
BANDA-VENT	K100579	BANDA-VENT- OPCIONAL	9525
POLEA DEL TENSOR-VENT	38076	BANDA-VENT	3/9525PB
TENSOR-VENT	38503	MANGUERA SILICÓN-TUBO A RAD.	SIH250363C
BANDA-TOMA DE FUERZA-ALT-AA	K080565	BANDA-TOMA DE FUERZA-ALT-AA C/ALT 135A	K080570
POLEA DEL TENSOR-TOMA DE FUERZA-ALT-AA	38075	BANDA-TOMA DE FUERZA-ALT-AA C/130 A	K080580
TENSOR-TOMA DE FUERZA-ALT-AA	38501	POLEA DEL TENSOR-TOMA DE FUERZA-ALT-AA	38075
MANGUERA INFERIOR-RAD. A TUBO	21135	TENSOR-TOMA DE FUERZA-ALT-AA	38501
MANGUERA SUPERIOR-RAD. A TUBO	21115	MANGUERA SILICÓN-MOTOR A TUBO	SIH250363C
MANGUERA SILICÓN-MOTOR A TUBO	SIH250363C	TERMOSTATO-190°	33599
TERMOSTATO-190°	33599	DETROIT DIESEL 6 CIL, 12.7 L DIESEL	
2006		2007	
BANDA-VENT	K100579	BANDA-VENT	K100579
POLEA DEL TENSOR-VENT	38076	POLEA DEL TENSOR-VENT	38076
TENSOR-VENT	38503	TENSOR-VENT	38503
BANDA-TOMA DE FUERZA-ALT-AA	K080565	BANDA-TOMA DE FUERZA-ALT-AA	K080565



MASTER SERVICIO PESADO 2014

FREIGHTLINER

CLASSIC

POLEA DEL TENSOR-TOMA DE FUERZA-ALT-AA	38075	BANDA-TOMA DE FUERZA-ALT-AA C/130 A	K080580
TENSOR-TOMA DE FUERZA-ALT-AA	38501	POLEA DEL TENSOR-TOMA DE FUERZA-ALT-AA	38075
MANGUERA INFERIOR-RAD. A TUBO	21135	TENSOR-TOMA DE FUERZA-ALT-AA	38501
MANGUERA SUPERIOR-RAD. A TUBO	21115	MANGUERA SILICÓN-MOTOR A TUBO	SIH250363C
MANGUERA SILICÓN-MOTOR A TUBO	SIH250363C	TERMOSTATO-190°	33599
TERMOSTATO-190°	33599	2002	
2006		BANDA-VENT- OPCIONAL	9525
BANDA-VENT	K100579	BANDA-VENT	3/9525PB
POLEA DEL TENSOR-VENT	38076	MANGUERA SILICÓN-TUBO A RAD.	SIH250363C
TENSOR-VENT	38503	BANDA-TOMA DE FUERZA-ALT-AA C/ALT 135A	K080575
BANDA-TOMA DE FUERZA-ALT-AA	K080565	BANDA-TOMA DE FUERZA-ALT-AA C/130 A	K080580
POLEA DEL TENSOR-TOMA DE FUERZA-ALT-AA	38075	POLEA DEL TENSOR-TOMA DE FUERZA-ALT-AA	38075
TENSOR-TOMA DE FUERZA-ALT-AA	38501	TENSOR-TOMA DE FUERZA-ALT-AA	38501
MANGUERA INFERIOR-RAD. A TUBO	21135	MANGUERA SILICÓN-MOTOR A TUBO	SIH250363C
MANGUERA SUPERIOR-RAD. A TUBO	21115	TERMOSTATO-190°	33599
MANGUERA SILICÓN-MOTOR A TUBO	SIH250363C	2001	
TERMOSTATO-190°	33599	BANDA-VENT- OPCIONAL	9525
2005		BANDA-VENT	3/9525PB
BANDA-VENT	K100579	MANGUERA SILICÓN-TUBO A RAD.	SIH250363C
POLEA DEL TENSOR-VENT	38076	MANGUERA SILICÓN-TUBO A RAD.	SIH300363C
TENSOR-VENT	38503	BANDA-TOMA DE FUERZA-ALT-AA C/ALT 135A	K080575
BANDA-TOMA DE FUERZA-ALT-AA	K080565	BANDA-TOMA DE FUERZA-ALT-AA C/130 A	K080580
POLEA DEL TENSOR-TOMA DE FUERZA-ALT-AA	38075	POLEA DEL TENSOR-TOMA DE FUERZA-ALT-AA	38075
TENSOR-TOMA DE FUERZA-ALT-AA	38501	TENSOR-TOMA DE FUERZA-ALT-AA	38501
MANGUERA INFERIOR-RAD. A TUBO	21135	MANGUERA SILICÓN-MOTOR A TUBO	SIH250363C
MANGUERA SUPERIOR-RAD. A TUBO	21115	MANGUERA SILICÓN-MOTOR A TUBO	SIH300363C
MANGUERA SILICÓN-MOTOR A TUBO	SIH250363C	TERMOSTATO-190°	33599
TERMOSTATO-190°	33599	DETROIT DIESEL 6 CIL, 11.1 L DIESEL	
2004		2002	
BANDA-VENT- OPCIONAL	9525	BANDA-VENT- OPCIONAL	9525
BANDA-VENT	3/9525PB	BANDA-VENT	3/9525PB
BANDA-VENT	K100579	MANGUERA SILICÓN-TUBO A RAD.	SIH250363C
MANGUERA SILICÓN-TUBO A RAD.	SIH250363C	BANDA-TOMA DE FUERZA-ALT-AA C/ALT 135A	K080575
BANDA-TOMA DE FUERZA-ALT-AA	K080570	BANDA-TOMA DE FUERZA-ALT-AA C/130 A	K080580
POLEA DEL TENSOR-TOMA DE FUERZA-ALT-AA	38075	POLEA DEL TENSOR-TOMA DE FUERZA-ALT-AA	38075
TENSOR-TOMA DE FUERZA-ALT-AA	38501	TENSOR-TOMA DE FUERZA-ALT-AA	38501
MANGUERA SILICÓN-MOTOR A TUBO	SIH250363C	MANGUERA SILICÓN-MOTOR A TUBO	SIH250363C
TERMOSTATO-190°	33599	TERMOSTATO-190°	33599
2003		2001	
BANDA-VENT- OPCIONAL	9525	BANDA-VENT- OPCIONAL	9525
BANDA-VENT	3/9525PB	BANDA-VENT	3/9525PB
MANGUERA SILICÓN-TUBO A RAD.	SIH250363C	MANGUERA SILICÓN-TUBO A RAD.	SIH250363C
BANDA-TOMA DE FUERZA-ALT-AA C/ALT 135A	K080570	MANGUERA SILICÓN-TUBO A RAD.	SIH300363C



MASTER SERVICIO PESADO 2014

FREIGHTLINER

CLASSIC

BANDA-TOMA DE FUERZA-ALT-AA C/ALT 135A	K080575	MANGUERA INFERIOR-MOTOR A ENFRIADOR	CHARTER 2 1/2"
BANDA-TOMA DE FUERZA-ALT-AA C/130 A	K080580	MANGUERA INFERIOR-ENFRIADOR A TUBO	CHARTER 3"
POLEA DEL TENSOR-TOMA DE FUERZA-ALT-AA	38075	POLEA DEL TENSOR-	36091
TENSOR-TOMA DE FUERZA-ALT-AA	38501	2002	
MANGUERA SILICÓN-MOTOR A TUBO	SIH250363C	MANGUERA INFERIOR-TUBO A RAD.	CHARTER 2 1/2"
MANGUERA SILICÓN-MOTOR A TUBO	SIH300363C	MANGUERA SUPERIOR-TUBO A RAD.	CHARTER 2 1/2"
TERMOSTATO-190°	33599	MANGUERA INFERIOR-TUBO A ENFRIADOR	21042
CUMMINS N14 DIESEL		BANDA-TOMA DE FUERZA-ALT-VENT	K080817
2002		TENSOR-TOMA DE FUERZA-ALT-VENT	38521
BANDA-VENT	2/TR28466PB	BANDA-TOMA DE FUERZA-AA	K060559
MANGUERA INFERIOR-TUBO A RAD.	CHARTER 3"	TENSOR-TOMA DE FUERZA-AA	38505
MANGUERA SUPERIOR-TUBO A RAD.	CHARTER 2 1/2"	MANGUERA SUPERIOR-MOTOR A TUBO	CHARTER 2 1/2"
BANDA-TOMA DE FUERZA-BA	K060425	MANGUERA INFERIOR-MOTOR A ENFRIADOR	CHARTER 2 1/2"
BANDA-TOMA DE FUERZA-AA	9435	MANGUERA INFERIOR-ENFRIADOR A TUBO	CHARTER 3"
MANGUERA INFERIOR-MOTOR A TUBO	CHARTER 2 1/2"	POLEA DEL TENSOR-	36091
MANGUERA SUPERIOR-MOTOR A TUBO	CHARTER 2 1/2"	2001	
BANDA-ALT	9451	MANGUERA SILICÓN-TUBO A RAD.	SIH250363C
TERMOSTATO-190°	33579	BANDA-TOMA DE FUERZA-ALT-VENT	K080817
TERMOSTATO-180°	33576	TENSOR-TOMA DE FUERZA-ALT-VENT	38521
TERMOSTATO-180°	33578	BANDA-TOMA DE FUERZA-AA	K060559
TERMOSTATO-170°	33577	TENSOR-TOMA DE FUERZA-AA	38505
2001		MANGUERA SILICÓN-MOTOR A TUBO	SIH250363C
MANGUERA SILICÓN-TUBO A RAD.	SIH250363C	MANGUERA SILICÓN-MOTOR A ENFRIADOR	SIH250363C
MANGUERA SILICÓN-TUBO A RAD.	SIH300363C	MANGUERA INFERIOR-ENFRIADOR A TUBO	CHARTER 3"
BANDA-TOMA DE FUERZA-VENT	TR28429	BANDA-ALT-VENT	K080816
BANDA-TOMA DE FUERZA-BA	K060425	POLEA DEL TENSOR-	36091
BANDA-TOMA DE FUERZA-AA	9435	CATERPILLAR C16 DIESEL	
MANGUERA SILICÓN-MOTOR A TUBO	SIH250363C	2003	
BANDA-ALT	9451	BANDA-VENT-AA	K060547
TERMOSTATO-190°	33579	POLEA DEL TENSOR-VENT-AA	36091
TERMOSTATO-180°	33576	TENSOR-VENT-AA	38508
TERMOSTATO-180°	33578	MANGUERA SILICÓN-TUBO A RAD.	SIH250363C
TERMOSTATO-170°	33577	MANGUERA SILICÓN-MOTOR A TUBO	SIH250363C
CUMMINS ISM DIESEL		MANGUERA SILICÓN-MOTOR A TUBO	SIH300363C
2003		BANDA-ALT-VENT	K080944
MANGUERA INFERIOR-TUBO A RAD.	CHARTER 2 1/2"	POLEA-ALT-VENT	36091
MANGUERA SUPERIOR-TUBO A RAD.	CHARTER 2 1/2"	TENSOR-ALT-VENT	38506
MANGUERA INFERIOR-TUBO A ENFRIADOR	21042	TERMOSTATO-190°	33579
BANDA-TOMA DE FUERZA-ALT-VENT	K080817	TERMOSTATO-180°	33576
TENSOR-TOMA DE FUERZA-ALT-VENT	38521	TERMOSTATO-180°	33578
BANDA-TOMA DE FUERZA-AA	K060559	TERMOSTATO-170°	33577
TENSOR-TOMA DE FUERZA-AA	38505	2002	
MANGUERA SUPERIOR-MOTOR A TUBO	24436	BANDA-VENT-AA	K060598



MASTER SERVICIO PESADO 2014

FREIGHTLINER

CLASSIC

POLEA DEL TENSOR-VENT-AA	36091	POLEA-MOTOR	36093
TENSOR-VENT-AA	38508	BANDA-ALT-VENT	K080991
MANGUERA INFERIOR-TUBO A RAD.	CHARTER 3"	POLEA-ALT-VENT	36091
MANGUERA SUPERIOR-TUBO A RAD.	CHARTER 2 1/2"	TENSOR-ALT-VENT	38506
MANGUERA INFERIOR-MOTOR A TUBO	CHARTER 3"	TERMOSTATO-190°	33579
MANGUERA SUPERIOR-MOTOR A TUBO	CHARTER 2 1/2"	TERMOSTATO-180°	33576
BANDA-ALT-VENT	K080952	TERMOSTATO-180°	33578
POLEA-ALT-VENT	36091	TERMOSTATO-170°	33577
TENSOR-ALT-VENT	38506	2005	
TERMOSTATO-190°	33579	BANDA-VENT-AA	K060586
TERMOSTATO-180°	33576	POLEA DEL TENSOR-VENT-AA	36091
TERMOSTATO-180°	33578	TENSOR-VENT-AA	38508
TERMOSTATO-170°	33577	MANGUERA SILICÓN-TUBO A RAD.	SIH250363C
2001		MANGUERA SUPERIOR-MOTOR A TUBO	21194
BANDA-VENT-AA	K060598	MANGUERA INFERIOR-MOTOR A RAD.	23015
POLEA DEL TENSOR-VENT-AA	36091	POLEA-MOTOR	36091
TENSOR-VENT-AA	38508	POLEA-MOTOR	36093
MANGUERA SILICÓN-TUBO A RAD.	SIH250363C	BANDA-ALT-VENT	K080991
MANGUERA SILICÓN-TUBO A RAD.	SIH300363C	POLEA-ALT-VENT	36091
MANGUERA SILICÓN-MOTOR A TUBO	SIH250363C	TENSOR-ALT-VENT	38506
MANGUERA SILICÓN-MOTOR A TUBO	SIH300363C	TERMOSTATO-190°	33579
BANDA-ALT-VENT	K080952	TERMOSTATO-180°	33576
POLEA-ALT-VENT	36091	TERMOSTATO-180°	33578
TENSOR-ALT-VENT	38506	TERMOSTATO-170°	33577
TERMOSTATO-190°	33579	2004	
TERMOSTATO-180°	33576	BANDA-VENT-AA	K060586
TERMOSTATO-180°	33578	POLEA DEL TENSOR-VENT-AA	36091
TERMOSTATO-170°	33577	TENSOR-VENT-AA	38508
CATERPILLAR C15 DIESEL		MANGUERA SILICÓN-TUBO A RAD.	SIH250363C
2007		MANGUERA SUPERIOR-MOTOR A TUBO	21194
POLEA-MOTOR	36091	MANGUERA INFERIOR-MOTOR A RAD.	23015
POLEA-MOTOR	36093	POLEA-MOTOR	36091
TERMOSTATO-190°	33579	POLEA-MOTOR	36093
TERMOSTATO-180°	33576	BANDA-ALT-VENT	K080991
TERMOSTATO-180°	33578	POLEA-ALT-VENT	36091
TERMOSTATO-170°	33577	TENSOR-ALT-VENT	38506
2006		TERMOSTATO-190°	33579
BANDA-VENT-AA	K060586	TERMOSTATO-180°	33576
POLEA DEL TENSOR-VENT-AA	36091	TERMOSTATO-180°	33578
TENSOR-VENT-AA	38508	TERMOSTATO-170°	33577
MANGUERA INFERIOR-MOTOR A RAD.	23015	2003	
MANGUERA SUPERIOR-MOTOR A RAD.	23229	BANDA-VENT-AA	K060547
POLEA-MOTOR	36091	POLEA DEL TENSOR-VENT-AA	36091



MASTER SERVICIO PESADO 2014

FREIGHTLINER

CLASSIC

TENSOR-VENT-AA	38508	POLEA-MOTOR	36093
MANGUERA SILICÓN-TUBO A RAD.	SIH250363C	TERMOSTATO-190°	33579
MANGUERA SILICÓN-MOTOR A TUBO	SIH250363C	TERMOSTATO-180°	33576
MANGUERA SILICÓN-MOTOR A TUBO	SIH300363C	TERMOSTATO-180°	33578
BANDA-ALT-VENT	K080944	TERMOSTATO-170°	33577
POLEA-ALT-VENT	36091	2006	
TENSOR-ALT-VENT	38506	POLEA-MOTOR	36093
TERMOSTATO-190°	33579	TERMOSTATO-190°	33579
TERMOSTATO-180°	33576	TERMOSTATO-180°	33576
TERMOSTATO-180°	33578	TERMOSTATO-180°	33578
TERMOSTATO-170°	33577	TERMOSTATO-170°	33577
2002		2005	
BANDA-VENT-AA	K060598	POLEA-MOTOR	36093
POLEA DEL TENSOR-VENT-AA	36091	TERMOSTATO-190°	33579
TENSOR-VENT-AA	38508	TERMOSTATO-180°	33576
MANGUERA INFERIOR-TUBO A RAD.	CHARTER 3"	TERMOSTATO-180°	33578
MANGUERA SUPERIOR-TUBO A RAD.	CHARTER 2 1/2"	TERMOSTATO-170°	33577
MANGUERA INFERIOR-MOTOR A TUBO	CHARTER 3"	2004	
MANGUERA SUPERIOR-MOTOR A TUBO	CHARTER 2 1/2"	POLEA-MOTOR	36093
BANDA-ALT-VENT	K080952	TERMOSTATO-190°	33579
POLEA-ALT-VENT	36091	TERMOSTATO-180°	33576
TENSOR-ALT-VENT	38506	TERMOSTATO-180°	33578
TERMOSTATO-190°	33579	TERMOSTATO-170°	33577
TERMOSTATO-180°	33576	CATERPILLAR C12 DIESEL	
TERMOSTATO-180°	33578	2004	
TERMOSTATO-170°	33577	POLEA-ALT-VENT	36091
2001		TERMOSTATO-190°	33579
BANDA-VENT-AA	K060598	TERMOSTATO-180°	33576
POLEA DEL TENSOR-VENT-AA	36091	TERMOSTATO-180°	33578
TENSOR-VENT-AA	38508	TERMOSTATO-170°	33577
MANGUERA SILICÓN-TUBO A RAD.	SIH250363C	2003	
MANGUERA SILICÓN-TUBO A RAD.	SIH300363C	POLEA-ALT-VENT	36091
MANGUERA SILICÓN-MOTOR A TUBO	SIH250363C	TERMOSTATO-190°	33579
MANGUERA SILICÓN-MOTOR A TUBO	SIH300363C	TERMOSTATO-180°	33576
BANDA-ALT-VENT	K080952	TERMOSTATO-180°	33578
POLEA-ALT-VENT	36091	TERMOSTATO-170°	33577
TENSOR-ALT-VENT	38506	2002	
TERMOSTATO-190°	33579	POLEA-ALT-VENT	36091
TERMOSTATO-180°	33576	TERMOSTATO-190°	33579
TERMOSTATO-180°	33578	TERMOSTATO-180°	33576
TERMOSTATO-170°	33577	TERMOSTATO-180°	33578
CATERPILLAR C13 DIESEL		TERMOSTATO-170°	33577
2007		2001	



POLEA-ALT-VENT	36091	CLASSIC XL	
TERMOSTATO-190°	33579		
TERMOSTATO-180°	33576		
TERMOSTATO-180°	33578		
TERMOSTATO-170°	33577		
CATERPILLAR C11 DIESEL			
2006			
POLEA-MOTOR	36093		
TERMOSTATO-190°	33579		
TERMOSTATO-180°	33576		
TERMOSTATO-180°	33578		
TERMOSTATO-170°	33577		
2005			
POLEA-MOTOR	36093		
TERMOSTATO-190°	33579		
TERMOSTATO-180°	33576		
TERMOSTATO-180°	33578		
TERMOSTATO-170°	33577		
2004			
POLEA-MOTOR	36093		
TERMOSTATO-190°	33579		
TERMOSTATO-180°	33576		
TERMOSTATO-180°	33578		
TERMOSTATO-170°	33577		
CATERPILLAR C10 DIESEL			
2003			
POLEA-ALT-VENT	36091		
TERMOSTATO-190°	33579		
TERMOSTATO-180°	33576		
TERMOSTATO-180°	33578		
TERMOSTATO-170°	33577		
2002			
POLEA-ALT-VENT	36091		
TERMOSTATO-190°	33579		
TERMOSTATO-180°	33576		
TERMOSTATO-180°	33578		
TERMOSTATO-170°	33577		
2001			
POLEA-ALT-VENT	36091		
TERMOSTATO-190°	33579		
TERMOSTATO-180°	33576		
TERMOSTATO-180°	33578		
TERMOSTATO-170°	33577		
		MERCEDES BENZ MBE 4000 Diesel	
		2010	
		BANDA-VENT	K080505
		TENSOR-VENT	38597
		MANGUERA INFERIOR-TUBO A RAD.	24047
		MANGUERA SUPERIOR-TUBO A RAD.	21891
		MANGUERA INFERIOR-MOTOR A TUBO	26045
		MANGUERA SUPERIOR-MOTOR A TUBO	24440
		BANDA-AA	K080855
		POLEA DEL TENSOR-AA	38075
		TENSOR-AA	38501
		2009	
		BANDA-VENT	K080505
		TENSOR-VENT	38597
		MANGUERA INFERIOR-TUBO A RAD.	24047
		MANGUERA SUPERIOR-TUBO A RAD.	21891
		MANGUERA INFERIOR-MOTOR A TUBO	26045
		MANGUERA SUPERIOR-MOTOR A TUBO	24440
		BANDA-AA	K080855
		POLEA DEL TENSOR-AA	38075
		TENSOR-AA	38501
		DETROIT DIESEL 6 CIL, 14.0 L DIESEL	
		2008	
		BANDA-VENT	K100502
		POLEA DEL TENSOR-VENT	38076
		TENSOR-VENT	38503
		BANDA-TOMA DE FUERZA-ALT-AA	K080570
		POLEA DEL TENSOR-TOMA DE FUERZA-ALT-AA	38075
		TENSOR-TOMA DE FUERZA-ALT-AA	38501
		MANGUERA INFERIOR-RAD. A TUBO	21891
		MANGUERA SILICÓN-RAD. A TUBO	SIH250363C
		MANGUERA SILICÓN-MOTOR A TUBO	SIH250363C
		TERMOSTATO-190°	33599
		2007	
		BANDA-VENT	K100579
		POLEA DEL TENSOR-VENT	38076
		TENSOR-VENT	38503
		BANDA-TOMA DE FUERZA-ALT-AA	K080565
		POLEA DEL TENSOR-TOMA DE FUERZA-ALT-AA	38075
		TENSOR-TOMA DE FUERZA-ALT-AA	38501
		MANGUERA INFERIOR-RAD. A TUBO	21135
		MANGUERA SUPERIOR-RAD. A TUBO	21115



MASTER SERVICIO PESADO 2014

FREIGHTLINER

CLASSIC XL

MANGUERA SILICÓN-MOTOR A TUBO	SIH250363C	TERMOSTATO-190°	33599
TERMOSTATO-190°	33599	2001	
2006		BANDA-VENT- OPCIONAL	9525
BANDA-VENT	K100579	BANDA-VENT	3/9525PB
POLEA DEL TENSOR-VENT	38076	MANGUERA SILICÓN-TUBO A RAD.	SIH250363C
TENSOR-VENT	38503	MANGUERA SILICÓN-TUBO A RAD.	SIH300363C
BANDA-TOMA DE FUERZA-ALT-AA	K080565	BANDA-TOMA DE FUERZA-ALT-AA C/ALT 135A	K080575
POLEA DEL TENSOR-TOMA DE FUERZA-ALT-AA	38075	BANDA-TOMA DE FUERZA-ALT-AA C/130 A	K080580
TENSOR-TOMA DE FUERZA-ALT-AA	38501	POLEA DEL TENSOR-TOMA DE FUERZA-ALT-AA	38075
MANGUERA INFERIOR-RAD. A TUBO	21135	TENSOR-TOMA DE FUERZA-ALT-AA	38501
MANGUERA SUPERIOR-RAD. A TUBO	21115	MANGUERA SILICÓN-MOTOR A TUBO	SIH250363C
MANGUERA SILICÓN-MOTOR A TUBO	SIH250363C	MANGUERA SILICÓN-MOTOR A TUBO	SIH300363C
TERMOSTATO-190°	33599	TERMOSTATO-190°	33599
2005		DETROIT DIESEL 6 CIL, 12.7 L DIESEL	
BANDA-VENT	K100579	2007	
POLEA DEL TENSOR-VENT	38076	BANDA-VENT	K100579
TENSOR-VENT	38503	POLEA DEL TENSOR-VENT	38076
BANDA-TOMA DE FUERZA-ALT-AA	K080565	TENSOR-VENT	38503
POLEA DEL TENSOR-TOMA DE FUERZA-ALT-AA	38075	BANDA-TOMA DE FUERZA-ALT-AA	K080565
TENSOR-TOMA DE FUERZA-ALT-AA	38501	POLEA DEL TENSOR-TOMA DE FUERZA-ALT-AA	38075
MANGUERA INFERIOR-RAD. A TUBO	21135	TENSOR-TOMA DE FUERZA-ALT-AA	38501
MANGUERA SUPERIOR-RAD. A TUBO	21115	MANGUERA INFERIOR-RAD. A TUBO	21135
MANGUERA SILICÓN-MOTOR A TUBO	SIH250363C	MANGUERA SUPERIOR-RAD. A TUBO	21115
TERMOSTATO-190°	33599	MANGUERA SILICÓN-MOTOR A TUBO	SIH250363C
2004		TERMOSTATO-190°	33599
BANDA-VENT- OPCIONAL	9525	2006	
BANDA-VENT	3/9525PB	BANDA-VENT	K100579
BANDA-VENT	K100579	POLEA DEL TENSOR-VENT	38076
MANGUERA SILICÓN-TUBO A RAD.	SIH250363C	TENSOR-VENT	38503
BANDA-TOMA DE FUERZA-ALT-AA	K080570	BANDA-TOMA DE FUERZA-ALT-AA	K080565
POLEA DEL TENSOR-TOMA DE FUERZA-ALT-AA	38075	POLEA DEL TENSOR-TOMA DE FUERZA-ALT-AA	38075
TENSOR-TOMA DE FUERZA-ALT-AA	38501	TENSOR-TOMA DE FUERZA-ALT-AA	38501
MANGUERA SILICÓN-MOTOR A TUBO	SIH250363C	MANGUERA INFERIOR-RAD. A TUBO	21135
TERMOSTATO-190°	33599	MANGUERA SUPERIOR-RAD. A TUBO	21115
2003		MANGUERA SILICÓN-MOTOR A TUBO	SIH250363C
BANDA-VENT- OPCIONAL	9525	TERMOSTATO-190°	33599
BANDA-VENT	3/9525PB	2005	
MANGUERA SILICÓN-TUBO A RAD.	SIH250363C	BANDA-VENT	K100579
BANDA-TOMA DE FUERZA-ALT-AA C/ALT 135A	K080570	POLEA DEL TENSOR-VENT	38076
BANDA-TOMA DE FUERZA-ALT-AA C/130 A	K080580	TENSOR-VENT	38503
POLEA DEL TENSOR-TOMA DE FUERZA-ALT-AA	38075	BANDA-TOMA DE FUERZA-ALT-AA	K080565
TENSOR-TOMA DE FUERZA-ALT-AA	38501	POLEA DEL TENSOR-TOMA DE FUERZA-ALT-AA	38075
MANGUERA SILICÓN-MOTOR A TUBO	SIH250363C	TENSOR-TOMA DE FUERZA-ALT-AA	38501



MASTER SERVICIO PESADO 2014

FREIGHTLINER

CLASSIC XL

MANGUERA INFERIOR-RAD. A TUBO	21135	MANGUERA SILICÓN-MOTOR A TUBO	SIH250363C
MANGUERA SUPERIOR-RAD. A TUBO	21150	MANGUERA SILICÓN-MOTOR A TUBO	SIH300363C
MANGUERA SILICÓN-MOTOR A TUBO	SIH250363C	TERMOSTATO-190°	33599
TERMOSTATO-190°	33599	DETROIT DIESEL 6 CIL, 11.1 L DIESEL	
2004		2002	
BANDA-VENT- OPCIONAL	9525	BANDA-VENT- OPCIONAL	9525
BANDA-VENT	3/9525PB	BANDA-VENT	3/9525PB
BANDA-VENT	K100579	MANGUERA SILICÓN-TUBO A RAD.	SIH250363C
MANGUERA SILICÓN-TUBO A RAD.	SIH250363C	BANDA-TOMA DE FUERZA-ALT-AA C/ALT 135A	K080575
BANDA-TOMA DE FUERZA-ALT-AA	K080570	BANDA-TOMA DE FUERZA-ALT-AA C/130 A	K080580
POLEA DEL TENSOR-TOMA DE FUERZA-ALT-AA	38075	POLEA DEL TENSOR-TOMA DE FUERZA-ALT-AA	38075
TENSOR-TOMA DE FUERZA-ALT-AA	38501	TENSOR-TOMA DE FUERZA-ALT-AA	38501
MANGUERA SILICÓN-MOTOR A TUBO	SIH250363C	MANGUERA SILICÓN-MOTOR A TUBO	SIH250363C
TERMOSTATO-190°	33599	TERMOSTATO-190°	33599
2003		2001	
BANDA-VENT- OPCIONAL	9525	BANDA-VENT- OPCIONAL	9525
BANDA-VENT	3/9525PB	BANDA-VENT	3/9525PB
MANGUERA SILICÓN-TUBO A RAD.	SIH250363C	MANGUERA SILICÓN-TUBO A RAD.	SIH250363C
BANDA-TOMA DE FUERZA-ALT-AA C/ALT 135A	K080570	MANGUERA SILICÓN-TUBO A RAD.	SIH300363C
BANDA-TOMA DE FUERZA-ALT-AA C/130 A	K080580	BANDA-TOMA DE FUERZA-ALT-AA C/ALT 135A	K080575
POLEA DEL TENSOR-TOMA DE FUERZA-ALT-AA	38075	BANDA-TOMA DE FUERZA-ALT-AA C/130 A	K080580
TENSOR-TOMA DE FUERZA-ALT-AA	38501	POLEA DEL TENSOR-TOMA DE FUERZA-ALT-AA	38075
MANGUERA SILICÓN-MOTOR A TUBO	SIH250363C	TENSOR-TOMA DE FUERZA-ALT-AA	38501
TERMOSTATO-190°	33599	MANGUERA SILICÓN-MOTOR A TUBO	SIH250363C
2002		MANGUERA SILICÓN-MOTOR A TUBO	SIH300363C
BANDA-VENT- OPCIONAL	9525	TERMOSTATO-190°	33599
BANDA-VENT	3/9525PB	CUMMINS N14 DIESEL	
MANGUERA SILICÓN-TUBO A RAD.	SIH250363C	2003	
BANDA-TOMA DE FUERZA-ALT-AA C/ALT 135A	K080575	BANDA-VENT	2/TR28466PB
BANDA-TOMA DE FUERZA-ALT-AA C/130 A	K080580	MANGUERA INFERIOR-TUBO A RAD.	CHARTER 3"
POLEA DEL TENSOR-TOMA DE FUERZA-ALT-AA	38075	MANGUERA SUPERIOR-TUBO A RAD.	CHARTER 2 1/2"
TENSOR-TOMA DE FUERZA-ALT-AA	38501	BANDA-TOMA DE FUERZA-BA	K060425
MANGUERA SILICÓN-MOTOR A TUBO	SIH250363C	BANDA-TOMA DE FUERZA-AA	9435
TERMOSTATO-190°	33599	MANGUERA INFERIOR-MOTOR A TUBO	CHARTER 2 1/2"
2001		MANGUERA SUPERIOR-MOTOR A TUBO	CHARTER 2 1/2"
BANDA-VENT- OPCIONAL	9525	BANDA-ALT	9451
BANDA-VENT	3/9525PB	2002	
MANGUERA SILICÓN-TUBO A RAD.	SIH250363C	BANDA-VENT	2/TR28466PB
MANGUERA SILICÓN-TUBO A RAD.	SIH300363C	MANGUERA INFERIOR-TUBO A RAD.	CHARTER 3"
BANDA-TOMA DE FUERZA-ALT-AA C/ALT 135A	K080575	MANGUERA SUPERIOR-TUBO A RAD.	CHARTER 2 1/2"
BANDA-TOMA DE FUERZA-ALT-AA C/130 A	K080580	BANDA-TOMA DE FUERZA-BA	K060425
POLEA DEL TENSOR-TOMA DE FUERZA-ALT-AA	38075	BANDA-TOMA DE FUERZA-AA	9435
TENSOR-TOMA DE FUERZA-ALT-AA	38501	MANGUERA INFERIOR-MOTOR A TUBO	CHARTER 2 1/2"



MANGUERA SUPERIOR-MOTOR A TUBO	CHARTER 2 1/2"	2001	
BANDA-ALT	9451	MANGUERA SILICÓN-TUBO A RAD.	SIH250363C
TERMOSTATO-190°	33579	MANGUERA SILICÓN-TUBO A ENFRIADOR	SIH250363C
TERMOSTATO-180°	33576	BANDA-TOMA DE FUERZA-AA	K060559
TERMOSTATO-180°	33578	SENSOR-TOMA DE FUERZA-AA	38505
TERMOSTATO-170°	33577	MANGUERA SILICÓN-MOTOR A TUBO	SIH250363C
2001		MANGUERA SILICÓN-MOTOR A ENFRIADOR	SIH250363C
MANGUERA SILICÓN-TUBO A RAD.	SIH250363C	BANDA-ALT-VENT	K080816
MANGUERA SILICÓN-TUBO A RAD.	SIH300363C	SENSOR-ALT-VENT	38521
BANDA-TOMA DE FUERZA-VENT	TR28429	POLEA DEL TENSOR-	36091
BANDA-TOMA DE FUERZA-BA	K060425	CATERPILLAR C16 DIESEL	
BANDA-TOMA DE FUERZA-AA	9435	2003	
MANGUERA SILICÓN-MOTOR A TUBO	SIH250363C	BANDA-VENT-AA	K060547
BANDA-ALT	9451	POLEA DEL TENSOR-VENT-AA	36091
TERMOSTATO-190°	33579	SENSOR-VENT-AA	38508
TERMOSTATO-180°	33576	MANGUERA SILICÓN-TUBO A RAD.	SIH250363C
TERMOSTATO-180°	33578	MANGUERA SILICÓN-MOTOR A TUBO	SIH250363C
TERMOSTATO-170°	33577	MANGUERA SILICÓN-MOTOR A TUBO	SIH300363C
CUMMINS ISM DIESEL		BANDA-ALT-VENT	K080944
2003		POLEA-ALT-VENT	36091
MANGUERA INFERIOR-TUBO A RAD.	CHARTER 2 1/2"	SENSOR-ALT-VENT	38506
MANGUERA SUPERIOR-TUBO A RAD.	CHARTER 2 1/2"	TERMOSTATO-190°	33579
MANGUERA INFERIOR-TUBO A ENFRIADOR	21042	TERMOSTATO-180°	33576
BANDA-TOMA DE FUERZA-ALT-VENT	K080817	TERMOSTATO-180°	33578
SENSOR-TOMA DE FUERZA-ALT-VENT	38521	TERMOSTATO-170°	33577
BANDA-TOMA DE FUERZA-AA	K060559	2002	
SENSOR-TOMA DE FUERZA-AA	38505	BANDA-VENT-AA	K060598
MANGUERA SUPERIOR-MOTOR A TUBO	24436	POLEA DEL TENSOR-VENT-AA	36091
MANGUERA INFERIOR-MOTOR A ENFRIADOR	CHARTER 2 1/2"	SENSOR-VENT-AA	38508
MANGUERA INFERIOR-ENFRIADOR A TUBO	CHARTER 3"	MANGUERA INFERIOR-TUBO A RAD.	CHARTER 3"
POLEA DEL TENSOR-	36091	MANGUERA SUPERIOR-TUBO A RAD.	CHARTER 2 1/2"
2002		MANGUERA INFERIOR-MOTOR A TUBO	CHARTER 3"
MANGUERA INFERIOR-TUBO A RAD.	CHARTER 2 1/2"	MANGUERA SUPERIOR-MOTOR A TUBO	CHARTER 2 1/2"
MANGUERA SUPERIOR-TUBO A RAD.	CHARTER 2 1/2"	BANDA-ALT-VENT	K080952
MANGUERA INFERIOR-TUBO A ENFRIADOR	21042	POLEA-ALT-VENT	36091
BANDA-TOMA DE FUERZA-ALT-VENT	K080817	SENSOR-ALT-VENT	38506
SENSOR-TOMA DE FUERZA-ALT-VENT	38521	TERMOSTATO-190°	33579
BANDA-TOMA DE FUERZA-AA	K060559	TERMOSTATO-180°	33576
SENSOR-TOMA DE FUERZA-AA	38505	TERMOSTATO-180°	33578
MANGUERA SUPERIOR-MOTOR A TUBO	CHARTER 2 1/2"	TERMOSTATO-170°	33577
MANGUERA INFERIOR-MOTOR A ENFRIADOR	CHARTER 2 1/2"	2001	
MANGUERA INFERIOR-ENFRIADOR A TUBO	CHARTER 3"	BANDA-VENT-AA	K060598
POLEA DEL TENSOR-	36091	POLEA DEL TENSOR-VENT-AA	36091



MASTER SERVICIO PESADO 2014

FREIGHTLINER

CLASSIC XL

TENSOR-VENT-AA	38508	POLEA-MOTOR	36091
MANGUERA SILICÓN-TUBO A RAD.	SIH250363C	POLEA-MOTOR	36093
MANGUERA SILICÓN-TUBO A RAD.	SIH300363C	BANDA-ALT-VENT	K080926
MANGUERA SILICÓN-MOTOR A TUBO	SIH250363C	TENSOR-ALT-VENT	38569
MANGUERA SILICÓN-MOTOR A TUBO	SIH300363C	TERMOSTATO-190°	33579
BANDA-ALT-VENT	K080952	TERMOSTATO-180°	33576
POLEA-ALT-VENT	36091	TERMOSTATO-180°	33578
TENSOR-ALT-VENT	38506	TERMOSTATO-170°	33577
TERMOSTATO-190°	33579	2004	
TERMOSTATO-180°	33576	BANDA-VENT-AA	K060547
TERMOSTATO-180°	33578	POLEA DEL TENSOR-VENT-AA	36091
TERMOSTATO-170°	33577	TENSOR-VENT-AA	38508
CATERPILLAR C15 DIESEL		MANGUERA SILICÓN-TUBO A RAD.	SIH250363C
2007		MANGUERA SILICÓN-MOTOR A TUBO	SIH250363C
POLEA-MOTOR	36091	MANGUERA SILICÓN-MOTOR A TUBO	SIH300363C
POLEA-MOTOR	36093	POLEA-MOTOR	36091
TERMOSTATO-190°	33579	POLEA-MOTOR	36093
TERMOSTATO-180°	33576	BANDA-ALT-VENT	K080944
TERMOSTATO-180°	33578	POLEA-ALT-VENT	36091
TERMOSTATO-170°	33577	TENSOR-ALT-VENT	38506
2006		TERMOSTATO-190°	33579
BANDA-VENT-AA	K060586	TERMOSTATO-180°	33576
POLEA DEL TENSOR-VENT-AA	36091	TERMOSTATO-180°	33578
TENSOR-VENT-AA	38508	TERMOSTATO-170°	33577
MANGUERA INFERIOR-MOTOR A RAD.	23015	2003	
MANGUERA SUPERIOR-MOTOR A RAD.	23229	BANDA-VENT-AA	K060547
POLEA-MOTOR	36091	POLEA DEL TENSOR-VENT-AA	36091
POLEA-MOTOR	36093	TENSOR-VENT-AA	38508
BANDA-ALT-VENT	K080991	MANGUERA SILICÓN-TUBO A RAD.	SIH250363C
POLEA-ALT-VENT	36091	MANGUERA SILICÓN-MOTOR A TUBO	SIH250363C
TENSOR-ALT-VENT	38506	MANGUERA SILICÓN-MOTOR A TUBO	SIH300363C
TERMOSTATO-190°	33579	BANDA-ALT-VENT	K080944
TERMOSTATO-180°	33576	POLEA-ALT-VENT	36091
TERMOSTATO-180°	33578	TENSOR-ALT-VENT	38506
TERMOSTATO-170°	33577	TERMOSTATO-190°	33579
2005		TERMOSTATO-180°	33576
BANDA-VENT-AA	K060635	TERMOSTATO-180°	33578
POLEA DEL TENSOR-VENT-AA	36091	TERMOSTATO-170°	33577
TENSOR-VENT-AA	38511	2002	
MANGUERA SILICÓN-RAD. A TUBO	SIH250363C	BANDA-VENT-AA	K060598
MANGUERA SUPERIOR-RAD. A TUBO	21891	POLEA DEL TENSOR-VENT-AA	36091
MANGUERA SILICÓN-MOTOR A TUBO	SIH250363C	TENSOR-VENT-AA	38508
MANGUERA SILICÓN-MOTOR A RAD.	SIH250363C	MANGUERA INFERIOR-TUBO A RAD.	CHARTER 3"



MANGUERA SUPERIOR-TUBO A RAD.	CHARTER 2 1/2"	2004	
MANGUERA INFERIOR-MOTOR A TUBO	CHARTER 3"	POLEA-MOTOR	36093
MANGUERA SUPERIOR-MOTOR A TUBO	CHARTER 2 1/2"	TERMOSTATO-190°	33579
BANDA-ALT-VENT	K080952	TERMOSTATO-180°	33576
POLEA-ALT-VENT	36091	TERMOSTATO-180°	33578
TENSOR-ALT-VENT	38506	TERMOSTATO-170°	33577
TERMOSTATO-190°	33579	CATERPILLAR C12 DIESEL	
TERMOSTATO-180°	33576	2003	
TERMOSTATO-180°	33578	POLEA-ALT-VENT	36091
TERMOSTATO-170°	33577	TERMOSTATO-190°	33579
2001		TERMOSTATO-180°	33576
BANDA-VENT-AA	K060598	TERMOSTATO-180°	33578
POLEA DEL TENSOR-VENT-AA	36091	TERMOSTATO-170°	33577
TENSOR-VENT-AA	38508	2002	
MANGUERA SILICÓN-TUBO A RAD.	SIH250363C	POLEA-ALT-VENT	36091
MANGUERA SILICÓN-TUBO A RAD.	SIH300363C	TERMOSTATO-190°	33579
MANGUERA SILICÓN-MOTOR A TUBO	SIH250363C	TERMOSTATO-180°	33576
MANGUERA SILICÓN-MOTOR A TUBO	SIH300363C	TERMOSTATO-180°	33578
BANDA-ALT-VENT	K080952	TERMOSTATO-170°	33577
POLEA-ALT-VENT	36091	2001	
TENSOR-ALT-VENT	38506	POLEA-ALT-VENT	36091
TERMOSTATO-190°	33579	TERMOSTATO-190°	33579
TERMOSTATO-180°	33576	TERMOSTATO-180°	33576
TERMOSTATO-180°	33578	TERMOSTATO-180°	33578
TERMOSTATO-170°	33577	TERMOSTATO-170°	33577
CATERPILLAR C13 DIESEL		CATERPILLAR C11 DIESEL	
2007		2006	
TERMOSTATO-190°	33579	POLEA-MOTOR	36093
TERMOSTATO-180°	33576	TERMOSTATO-190°	33579
TERMOSTATO-180°	33578	TERMOSTATO-180°	33576
TERMOSTATO-170°	33577	TERMOSTATO-180°	33578
2006		TERMOSTATO-170°	33577
POLEA-MOTOR	36093	2005	
TERMOSTATO-190°	33579	POLEA-MOTOR	36093
TERMOSTATO-180°	33576	TERMOSTATO-190°	33579
TERMOSTATO-180°	33578	TERMOSTATO-180°	33576
TERMOSTATO-170°	33577	TERMOSTATO-180°	33578
2005		TERMOSTATO-170°	33577
POLEA-MOTOR	36093	2004	
TERMOSTATO-190°	33579	POLEA-MOTOR	36093
TERMOSTATO-180°	33576	TERMOSTATO-190°	33579
TERMOSTATO-180°	33578	TERMOSTATO-180°	33576
TERMOSTATO-170°	33577	TERMOSTATO-180°	33578
		TERMOSTATO-180°	33578



TERMOSTATO-170°	33577	POLEA DEL TENSOR-TOMA DE FUERZA-ALT-AA	38075
CATERPILLAR C10 DIESEL		TENSOR-TOMA DE FUERZA-ALT-AA	38501
2003		MANGUERA INFERIOR-MOTOR A RAD.	23013
POLEA-ALT-VENT	36091	MANGUERA SUPERIOR-MOTOR A RAD.	22959
TERMOSTATO-190°	33579	2004	
TERMOSTATO-180°	33576	BANDA-VENT	K080672
TERMOSTATO-180°	33578	MANGUERA SILICÓN-TUBO A RAD.	SIH250363C
TERMOSTATO-170°	33577	MANGUERA SUPERIOR-TUBO A RAD.	CHARTER 2 1/2"
2002		BANDA-TOMA DE FUERZA-ALT	K090609
POLEA-ALT-VENT	36091	TENSOR-TOMA DE FUERZA-ALT	38541
TERMOSTATO-190°	33579	MANGUERA INFERIOR-MOTOR A TUBO	21891
TERMOSTATO-180°	33576	MANGUERA SILICÓN-MOTOR A TUBO	SIH250363C
TERMOSTATO-180°	33578	MANGUERA SUPERIOR-MOTOR A RAD.	CHARTER 2 1/2"
TERMOSTATO-170°	33577	BANDA-AA	K060439
2001		TENSOR-AA	38540
POLEA-ALT-VENT	36091	MANGUERA INFERIOR-	CHARTER 2 1/2"
TERMOSTATO-190°	33579	2003	
TERMOSTATO-180°	33576	BANDA-VENT	K080672
TERMOSTATO-180°	33578	MANGUERA SILICÓN-TUBO A RAD.	SIH250363C
TERMOSTATO-170°	33577	BANDA-TOMA DE FUERZA-ALT	K090609
COLUMBIA		TENSOR-TOMA DE FUERZA-ALT	38541
MERCEDES-BENZ MBE 4000 DIESEL		MANGUERA INFERIOR-MOTOR A TUBO	21891
2007		MANGUERA SILICÓN-MOTOR A TUBO	SIH250363C
BANDA-VENT	K080505	BANDA-AA	K060439
TENSOR-VENT	38597	TENSOR-AA	38540
BANDA-TOMA DE FUERZA-ALT-AA	K080855	MERCEDES BENZ MBE 4000 Diesel	
POLEA DEL TENSOR-TOMA DE FUERZA-ALT-AA	38075	2010	
TENSOR-TOMA DE FUERZA-ALT-AA	38501	BANDA-VENT	K080505
MANGUERA INFERIOR-MOTOR A RAD.	23171	TENSOR-VENT	38597
MANGUERA SUPERIOR-MOTOR A RAD.	22959	MANGUERA INFERIOR-TUBO A RAD.	24047
2006		MANGUERA SUPERIOR-TUBO A RAD.	21891
BANDA-VENT	K080505	MANGUERA INFERIOR-MOTOR A TUBO	26045
TENSOR-VENT	38597	MANGUERA SUPERIOR-MOTOR A TUBO	24440
BANDA-TOMA DE FUERZA-ALT-AA	K080855	BANDA-AA	K080855
POLEA DEL TENSOR-TOMA DE FUERZA-ALT-AA	38075	POLEA DEL TENSOR-AA	38075
TENSOR-TOMA DE FUERZA-ALT-AA	38501	TENSOR-AA	38501
MANGUERA INFERIOR-MOTOR A RAD.	23171	2009	
MANGUERA SUPERIOR-MOTOR A RAD.	22959	BANDA-VENT	K080505
2005		TENSOR-VENT	38597
BANDA-VENT	K080575	MANGUERA INFERIOR-TUBO A RAD.	24047
TENSOR-VENT	38597	MANGUERA SUPERIOR-TUBO A RAD.	21891
BANDA-TOMA DE FUERZA-ALT-AA	K080855	MANGUERA INFERIOR-MOTOR A TUBO	26045
POLEA-TOMA DE FUERZA-ALT-AA	38075	MANGUERA SUPERIOR-MOTOR A TUBO	24440



MASTER SERVICIO PESADO 2014

FREIGHTLINER

COLUMBIA

BANDA-AA	K080855	BANDA-TOMA DE FUERZA-ALT-AA (ALT. 135A)	K080570
POLEA DEL TENSOR-AA	38075	BANDA-TOMA DE FUERZA-ALT-AA (ALT. 130A)	K080580
TENSOR-AA	38501	MANGUERA SUPERIOR-MOTOR A TUBO	21891
2008		MANGUERA INFERIOR-	CHARTER 2 1/2"
BANDA-VENT	K080505	2002	
TENSOR-VENT	38597	BANDA-VENT	PQ17500
MANGUERA INFERIOR-TUBO A RAD.	24047	MANGUERA SUPERIOR-TUBO A RAD.	CHARTER 2 1/2"
MANGUERA SUPERIOR-TUBO A RAD.	21891	BANDA-TOMA DE FUERZA-ALT-AA (ALT. 135A)	K080570
MANGUERA INFERIOR-MOTOR A TUBO	26045	BANDA-TOMA DE FUERZA-ALT-AA (ALT. 130A)	K080580
MANGUERA SUPERIOR-MOTOR A TUBO	24440	MANGUERA SUPERIOR-MOTOR A TUBO	21891
BANDA-AA	K080855	MANGUERA INFERIOR-	CHARTER 2 1/2"
POLEA DEL TENSOR-AA	38075	2001	
TENSOR-AA	38501	BANDA-VENT	PQ17500
DETROIT DIESEL SERIE 60		MANGUERA SUPERIOR-TUBO A RAD.	CHARTER 2 1/2"
2006		BANDA-TOMA DE FUERZA-ALT-AA	K080570
BANDA-VENT	K100502	MANGUERA SUPERIOR-MOTOR A TUBO	21891
POLEA-VENT	38076	POLEA-LOCA	38075
TENSOR-VENT	38503	MANGUERA INFERIOR-	CHARTER 2 1/2"
BANDA-TOMA DE FUERZA-ALT-AA	K080565	TENSOR-	38501
POLEA-TOMA DE FUERZA-ALT-AA	38075	DETROIT DIESEL 6 CIL, 14.0 L DIESEL	
TENSOR-TOMA DE FUERZA-ALT-AA	38501	2011	
MANGUERA SUPERIOR-RAD. A TUBO	CHARTER 2 1/2"	BANDA-VENT	K100502
MANGUERA SUPERIOR-MOTOR A RAD.	21135	POLEA DEL TENSOR-VENT	38076
MANGUERA SUPERIOR-MOTOR A RAD.	22877	TENSOR-VENT	38503
2005		MANGUERA INFERIOR-TUBO A MOTOR	20987
BANDA-VENT	K100502	BANDA-TOMA DE FUERZA-ALT-AA	K100557
POLEA-VENT	38076	POLEA DEL TENSOR-TOMA DE FUERZA-ALT-AA	38075
TENSOR-VENT	38503	TENSOR-TOMA DE FUERZA-ALT-AA	38501
BANDA-TOMA DE FUERZA-ALT-AA	K080565	MANGUERA INFERIOR-RAD. A TUBO	20987
POLEA-TOMA DE FUERZA-ALT-AA	38075	MANGUERA SILICÓN-RAD. A TUBO	SIH250363C
TENSOR-TOMA DE FUERZA-ALT-AA	38501	MANGUERA SILICÓN-MOTOR A TUBO	SIH250363C
MANGUERA SUPERIOR-MOTOR A TUBO	CHARTER 2 1/2"	TERMOSTATO-190°	33599
MANGUERA SUPERIOR-MOTOR A RAD.	21135	2010	
2004		BANDA-VENT	K100502
TENSOR-VENT	38503	POLEA DEL TENSOR-VENT	38076
BANDA-TOMA DE FUERZA-ALT-AA	K080565	TENSOR-VENT	38503
TENSOR-TOMA DE FUERZA-ALT-AA	38501	MANGUERA INFERIOR-TUBO A MOTOR	20987
MANGUERA SUPERIOR-MOTOR A TUBO	CHARTER 2 1/2"	BANDA-TOMA DE FUERZA-ALT-AA	K080570
MANGUERA SUPERIOR-MOTOR A RAD.	21135	POLEA DEL TENSOR-TOMA DE FUERZA-ALT-AA	38075
2003		TENSOR-TOMA DE FUERZA-ALT-AA	38501
TENSOR-VENT-AA	38501	MANGUERA INFERIOR-RAD. A TUBO	20987
BANDA-VENT	PQ17500	MANGUERA SILICÓN-RAD. A TUBO	SIH250363C
MANGUERA SUPERIOR-TUBO A RAD.	CHARTER 2 1/2"	MANGUERA SILICÓN-MOTOR A TUBO	SIH250363C



MASTER SERVICIO PESADO 2014

FREIGHTLINER

COLUMBIA

TERMOSTATO-190°	33599	MANGUERA INFERIOR-MOTOR A RAD.	22877
2009		MANGUERA SUPERIOR-MOTOR A RAD.	21135
BANDA-VENT	K100502	TERMOSTATO-190°	33599
POLEA DEL TENSOR-VENT	38076	2005	
TENSOR-VENT	38503	BANDA-VENT	K100502
MANGUERA INFERIOR-TUBO A MOTOR	20987	POLEA DEL TENSOR-VENT	38076
BANDA-TOMA DE FUERZA-ALT-AA	K080570	TENSOR-VENT	38503
POLEA DEL TENSOR-TOMA DE FUERZA-ALT-AA	38075	BANDA-TOMA DE FUERZA-ALT-AA	K080565
TENSOR-TOMA DE FUERZA-ALT-AA	38501	POLEA DEL TENSOR-TOMA DE FUERZA-ALT-AA	38075
MANGUERA INFERIOR-RAD. A TUBO	20987	TENSOR-TOMA DE FUERZA-ALT-AA	38501
MANGUERA SILICÓN-RAD. A TUBO	SIH250363C	MANGUERA SILICÓN-RAD. A TUBO	SIH250363C
MANGUERA SILICÓN-MOTOR A TUBO	SIH250363C	MANGUERA INFERIOR-MOTOR A RAD.	22877
TERMOSTATO-190°	33599	MANGUERA SUPERIOR-MOTOR A RAD.	21135
2008		TERMOSTATO-190°	33599
BANDA-VENT	K100502	2004	
POLEA DEL TENSOR-VENT	38076	BANDA-VENT	K100502
TENSOR-VENT	38503	POLEA DEL TENSOR-VENT	38076
BANDA-TOMA DE FUERZA-ALT-AA	K080570	TENSOR-VENT	38503
POLEA DEL TENSOR-TOMA DE FUERZA-ALT-AA	38075	BANDA-TOMA DE FUERZA-ALT-AA	K080565
TENSOR-TOMA DE FUERZA-ALT-AA	38501	POLEA DEL TENSOR-TOMA DE FUERZA-ALT-AA	38075
MANGUERA INFERIOR-RAD. A TUBO	21115	TENSOR-TOMA DE FUERZA-ALT-AA	38501
MANGUERA SILICÓN-RAD. A TUBO	SIH250363C	MANGUERA SILICÓN-RAD. A TUBO	SIH250363C
MANGUERA SILICÓN-MOTOR A TUBO	SIH250363C	MANGUERA INFERIOR-MOTOR A RAD.	22877
TERMOSTATO-190°	33599	MANGUERA SUPERIOR-MOTOR A RAD.	21135
2007		TERMOSTATO-190°	33599
BANDA-VENT	K100502	2003	
POLEA DEL TENSOR-VENT	38076	BANDA-VENT- OPCIONAL	9500
TENSOR-VENT	38503	BANDA-VENT	3/9500PB
BANDA-TOMA DE FUERZA-ALT-AA	K080565	MANGUERA SILICÓN-TUBO A RAD.	SIH250363C
POLEA DEL TENSOR-TOMA DE FUERZA-ALT-AA	38075	BANDA-TOMA DE FUERZA-ALT-AA C/ALT 135A	K080570
TENSOR-TOMA DE FUERZA-ALT-AA	38501	BANDA-TOMA DE FUERZA-ALT-AA C/130 A	K080580
MANGUERA SILICÓN-RAD. A TUBO	SIH250363C	POLEA DEL TENSOR-TOMA DE FUERZA-ALT-AA	38075
MANGUERA INFERIOR-MOTOR A RAD.	22877	TENSOR-TOMA DE FUERZA-ALT-AA	38501
MANGUERA SILICÓN-MOTOR A RAD.	SIH250363C	MANGUERA SILICÓN-MOTOR A TUBO	SIH250363C
TERMOSTATO-190°	33599	MANGUERA SUPERIOR-MOTOR A TUBO	21891
2006		TERMOSTATO-190°	33599
BANDA-VENT	K100502	2002	
POLEA DEL TENSOR-VENT	38076	BANDA-VENT- OPCIONAL	9500
TENSOR-VENT	38503	BANDA-VENT	3/9500PB
BANDA-TOMA DE FUERZA-ALT-AA	K080565	MANGUERA SILICÓN-TUBO A RAD.	SIH250363C
POLEA DEL TENSOR-TOMA DE FUERZA-ALT-AA	38075	BANDA-TOMA DE FUERZA-ALT-AA C/ALT 135A	K080570
TENSOR-TOMA DE FUERZA-ALT-AA	38501	BANDA-TOMA DE FUERZA-ALT-AA C/130 A	K080580
MANGUERA SILICÓN-RAD. A TUBO	SIH250363C	POLEA DEL TENSOR-TOMA DE FUERZA-ALT-AA	38075



MASTER SERVICIO PESADO 2014

FREIGHTLINER

COLUMBIA

TENSOR-TOMA DE FUERZA-ALT-AA	38501	POLEA DEL TENSOR-TOMA DE FUERZA-ALT-AA	38075
MANGUERA SILICÓN-MOTOR A TUBO	SIH250363C	TENSOR-TOMA DE FUERZA-ALT-AA	38501
MANGUERA SUPERIOR-MOTOR A TUBO	21891	MANGUERA SILICÓN-RAD. A TUBO	SIH250363C
TERMOSTATO-190°	33599	MANGUERA INFERIOR-MOTOR A RAD.	22877
DETROIT DIESEL 6 CIL, 12.7 L DIESEL		MANGUERA SUPERIOR-MOTOR A RAD.	21135
2009		TERMOSTATO-190°	33599
BANDA-VENT	K100502	2005	
POLEA DEL TENSOR-VENT	38076	BANDA-VENT	K100502
TENSOR-VENT	38503	POLEA DEL TENSOR-VENT	38076
BANDA-TOMA DE FUERZA-ALT-AA	K080565	TENSOR-VENT	38503
POLEA DEL TENSOR-TOMA DE FUERZA-ALT-AA	38075	BANDA-TOMA DE FUERZA-ALT-AA	K080565
TENSOR-TOMA DE FUERZA-ALT-AA	38501	POLEA DEL TENSOR-TOMA DE FUERZA-ALT-AA	38075
MANGUERA SILICÓN-RAD. A TUBO	SIH250363C	TENSOR-TOMA DE FUERZA-ALT-AA	38501
MANGUERA INFERIOR-MOTOR A RAD.	22877	MANGUERA SILICÓN-RAD. A TUBO	SIH250363C
MANGUERA SILICÓN-MOTOR A RAD.	SIH250363C	MANGUERA INFERIOR-MOTOR A RAD.	22877
TERMOSTATO-190°	33599	MANGUERA SUPERIOR-MOTOR A RAD.	21135
2008		TERMOSTATO-190°	33599
BANDA-VENT	K100502	2004	
POLEA DEL TENSOR-VENT	38076	BANDA-VENT	K100502
TENSOR-VENT	38503	POLEA DEL TENSOR-VENT	38076
BANDA-TOMA DE FUERZA-ALT-AA	K080565	TENSOR-VENT	38503
POLEA DEL TENSOR-TOMA DE FUERZA-ALT-AA	38075	BANDA-TOMA DE FUERZA-ALT-AA	K080565
TENSOR-TOMA DE FUERZA-ALT-AA	38501	POLEA DEL TENSOR-TOMA DE FUERZA-ALT-AA	38075
MANGUERA SILICÓN-RAD. A TUBO	SIH250363C	TENSOR-TOMA DE FUERZA-ALT-AA	38501
MANGUERA INFERIOR-MOTOR A RAD.	22877	MANGUERA SILICÓN-RAD. A TUBO	SIH250363C
MANGUERA SILICÓN-MOTOR A RAD.	SIH250363C	MANGUERA INFERIOR-MOTOR A RAD.	22877
TERMOSTATO-190°	33599	MANGUERA SUPERIOR-MOTOR A RAD.	21135
2007		TERMOSTATO-190°	33599
BANDA-VENT	K100502	2003	
POLEA DEL TENSOR-VENT	38076	BANDA-VENT- OPCIONAL	9500
TENSOR-VENT	38503	BANDA-VENT	3/9500PB
BANDA-TOMA DE FUERZA-ALT-AA	K080565	MANGUERA SILICÓN-TUBO A RAD.	SIH250363C
POLEA DEL TENSOR-TOMA DE FUERZA-ALT-AA	38075	BANDA-TOMA DE FUERZA-ALT-AA C/ALT 135A	K080570
TENSOR-TOMA DE FUERZA-ALT-AA	38501	BANDA-TOMA DE FUERZA-ALT-AA C/130 A	K080580
MANGUERA SILICÓN-RAD. A TUBO	SIH250363C	POLEA DEL TENSOR-TOMA DE FUERZA-ALT-AA	38075
MANGUERA INFERIOR-MOTOR A RAD.	22877	TENSOR-TOMA DE FUERZA-ALT-AA	38501
MANGUERA SILICÓN-MOTOR A RAD.	SIH250363C	MANGUERA SILICÓN-MOTOR A TUBO	SIH250363C
TERMOSTATO-190°	33599	MANGUERA SUPERIOR-MOTOR A TUBO	21891
2006		TERMOSTATO-190°	33599
BANDA-VENT	K100502	2002	
POLEA DEL TENSOR-VENT	38076	BANDA-VENT- OPCIONAL	9500
TENSOR-VENT	38503	BANDA-VENT	3/9500PB
BANDA-TOMA DE FUERZA-ALT-AA	K080565	MANGUERA SILICÓN-TUBO A RAD.	SIH250363C



MASTER SERVICIO PESADO 2014

FREIGHTLINER

COLUMBIA

BANDA-TOMA DE FUERZA-ALT-AA C/ALT 135A	K080570	BANDA-VENT	3/9500PB
BANDA-TOMA DE FUERZA-ALT-AA C/130 A	K080580	MANGUERA SILICÓN-TUBO A RAD.	SIH250363C
POLEA DEL TENSOR-TOMA DE FUERZA-ALT-AA	38075	BANDA-TOMA DE FUERZA-ALT-AA C/ALT 135A	K080570
TENSOR-TOMA DE FUERZA-ALT-AA	38501	BANDA-TOMA DE FUERZA-ALT-AA C/130 A	K080580
MANGUERA SILICÓN-MOTOR A TUBO	SIH250363C	POLEA DEL TENSOR-TOMA DE FUERZA-ALT-AA	38075
MANGUERA SUPERIOR-MOTOR A TUBO	21891	TENSOR-TOMA DE FUERZA-ALT-AA	38501
TERMOSTATO-190°	33599	MANGUERA SILICÓN-MOTOR A TUBO	SIH250363C
2001		MANGUERA SUPERIOR-MOTOR A TUBO	21891
BANDA-VENT- OPCIONAL	9500	TERMOSTATO-190°	33599
BANDA-VENT	3/9500PB	CUMMINS N14 DIESEL	
MANGUERA SILICÓN-TUBO A RAD.	SIH250363C	2009	
BANDA-TOMA DE FUERZA-ALT-AA C/ALT 135A	K080570	TERMOSTATO-190°	33579
BANDA-TOMA DE FUERZA-ALT-AA C/130 A	K080580	TERMOSTATO-180°	33576
POLEA DEL TENSOR-TOMA DE FUERZA-ALT-AA	38075	TERMOSTATO-180°	33578
TENSOR-TOMA DE FUERZA-ALT-AA	38501	TERMOSTATO-170°	33577
MANGUERA SILICÓN-MOTOR A TUBO	SIH250363C	2008	
MANGUERA SUPERIOR-MOTOR A TUBO	21891	TERMOSTATO-190°	33579
TERMOSTATO-190°	33599	TERMOSTATO-180°	33576
2000		TERMOSTATO-180°	33578
BANDA-VENT- OPCIONAL	9500	TERMOSTATO-170°	33577
BANDA-VENT	3/9500PB	2007	
MANGUERA SILICÓN-TUBO A RAD.	SIH250363C	TERMOSTATO-190°	33579
BANDA-TOMA DE FUERZA-ALT-AA C/ALT 135A	K080570	TERMOSTATO-180°	33576
BANDA-TOMA DE FUERZA-ALT-AA C/130 A	K080580	TERMOSTATO-180°	33578
POLEA DEL TENSOR-TOMA DE FUERZA-ALT-AA	38075	TERMOSTATO-170°	33577
TENSOR-TOMA DE FUERZA-ALT-AA	38501	2006	
MANGUERA SILICÓN-MOTOR A TUBO	SIH250363C	TERMOSTATO-190°	33579
MANGUERA SUPERIOR-MOTOR A TUBO	21891	TERMOSTATO-180°	33576
TERMOSTATO-190°	33599	TERMOSTATO-180°	33578
DETROIT DIESEL 6 CIL, 11.1 L DIESEL		TERMOSTATO-170°	33577
2001		2005	
BANDA-VENT- OPCIONAL	9500	TERMOSTATO-190°	33579
BANDA-VENT	3/9500PB	TERMOSTATO-180°	33576
MANGUERA SILICÓN-TUBO A RAD.	SIH250363C	TERMOSTATO-180°	33578
BANDA-TOMA DE FUERZA-ALT-AA C/ALT 135A	K080570	TERMOSTATO-170°	33577
BANDA-TOMA DE FUERZA-ALT-AA C/130 A	K080580	2003	
POLEA DEL TENSOR-TOMA DE FUERZA-ALT-AA	38075	MANGUERA SILICÓN-TUBO A RAD.	SIH250363C
TENSOR-TOMA DE FUERZA-ALT-AA	38501	BANDA-TOMA DE FUERZA-VENT	TR28445
MANGUERA SILICÓN-MOTOR A TUBO	SIH250363C	BANDA-TOMA DE FUERZA-BA	K060425
MANGUERA SUPERIOR-MOTOR A TUBO	21891	BANDA-TOMA DE FUERZA-AA	9447
TERMOSTATO-190°	33599	MANGUERA SILICÓN-MOTOR A RAD.	SIH250363C
2000		BANDA-ALT	9451
BANDA-VENT- OPCIONAL	9500	TERMOSTATO-190°	33579



MASTER SERVICIO PESADO 2014

FREIGHTLINER

COLUMBIA

TERMOSTATO-180°	33576	BANDA-TOMA DE FUERZA-AA	K060559
TERMOSTATO-180°	33578	TENSOR-TOMA DE FUERZA-AA	38505
TERMOSTATO-170°	33577	MANGUERA INFERIOR-MOTOR A TUBO	CHARTER 2 1/2"
2002		MANGUERA SUPERIOR-MOTOR A TUBO	CHARTER 2 1/4"
TERMOSTATO-190°	33579	BANDA-ALT-VENT	K080745
TERMOSTATO-180°	33576	TENSOR-ALT-VENT	38521
TERMOSTATO-180°	33578	POLEA DEL TENSOR-	36091
TERMOSTATO-170°	33577	CATERPILLAR C16 DIESEL	
2001		2008	
TERMOSTATO-190°	33579	TERMOSTATO-190°	33579
TERMOSTATO-180°	33576	TERMOSTATO-180°	33576
TERMOSTATO-180°	33578	TERMOSTATO-180°	33578
TERMOSTATO-170°	33577	TERMOSTATO-170°	33577
CUMMINS ISX DIESEL		2007	
2001		TERMOSTATO-190°	33579
MANGUERA INFERIOR-TUBO A RAD.	21891	TERMOSTATO-180°	33576
MANGUERA SILICÓN-TUBO A RAD.	SIH250363C	TERMOSTATO-180°	33578
BANDA-TOMA DE FUERZA-VENT	K100710	TERMOSTATO-170°	33577
POLEA DEL TENSOR-TOMA DE FUERZA-VENT	36092	2004	
TENSOR-TOMA DE FUERZA-VENT	38535	BANDA-VENT-AA	K060547
BANDA-TOMA DE FUERZA-ALT-AA	K060685	POLEA DEL TENSOR-VENT-AA	36091
POLEA DEL TENSOR-TOMA DE FUERZA-ALT-AA	36095	TENSOR-VENT-AA	38508
TENSOR-TOMA DE FUERZA-ALT-AA	38532	MANGUERA SILICÓN-TUBO A RAD.	SIH250363C
MANGUERA SILICÓN-MOTOR A TUBO	SIH250363C	BANDA-TOMA DE FUERZA-ALT-AA C/ALT 135A	K080939
CUMMINS ISM DIESEL		MANGUERA INFERIOR-MOTOR A TUBO	24452
2007		MANGUERA SILICÓN-MOTOR A TUBO	SIH250363C
BANDA-ALT	K080730	BANDA-ALT-VENT C/130A	K080944
BANDA-AA	K060575	POLEA-ALT-VENT	36091
2003		TENSOR-ALT-VENT	38506
BANDA-TOMA DE FUERZA-AA	K060575	TERMOSTATO-190°	33579
TENSOR-TOMA DE FUERZA-AA	38505	TERMOSTATO-180°	33576
BANDA-ALT-VENT	K080730	TERMOSTATO-180°	33578
TENSOR-ALT-VENT	38521	TERMOSTATO-170°	33577
POLEA DEL TENSOR-	36091	2003	
2002		BANDA-VENT-AA	K060547
BANDA-TOMA DE FUERZA-AA	K060575	POLEA DEL TENSOR-VENT-AA	36091
TENSOR-TOMA DE FUERZA-AA	38505	TENSOR-VENT-AA	38508
BANDA-ALT-VENT	K080730	MANGUERA SILICÓN-TUBO A RAD.	SIH250363C
TENSOR-ALT-VENT	38521	BANDA-TOMA DE FUERZA-ALT-AA C/ALT 135A	K080939
POLEA DEL TENSOR-	36091	MANGUERA INFERIOR-MOTOR A TUBO	24452
2001		MANGUERA SILICÓN-MOTOR A TUBO	SIH250363C
MANGUERA SILICÓN-TUBO A RAD.	SIH250363C	BANDA-ALT-VENT C/130A	K080944
MANGUERA SUPERIOR-TUBO A RAD.	CHARTER 2 1/2"	POLEA-ALT-VENT	36091



MASTER SERVICIO PESADO 2014

FREIGHTLINER

COLUMBIA

TENSOR-ALT-VENT	38506	BANDA-VENT	K120985
TERMOSTATO-190°	33579	POLEA-MOTOR	36091
TERMOSTATO-180°	33576	POLEA-MOTOR	36093
TERMOSTATO-180°	33578	TENSOR-ALT-VENT	38636
TERMOSTATO-170°	33577	POLEA-AA INFERIOR	36282
2002		BANDA-AA	K060723
BANDA-VENT-AA	K060547	TENSOR-AA	38609
POLEA DEL TENSOR-VENT-AA	36091	TERMOSTATO-190°	33579
TENSOR-VENT-AA	38508	TERMOSTATO-180°	33576
MANGUERA SILICÓN-TUBO A RAD.	SIH250363C	TERMOSTATO-180°	33578
BANDA-TOMA DE FUERZA-ALT-AA C/ALT 135A	K080939	TERMOSTATO-170°	33577
MANGUERA INFERIOR-MOTOR A TUBO	24452	BOMBA DE AGUA-	44062HD
MANGUERA SILICÓN-MOTOR A TUBO	SIH250363C	2007	
BANDA-ALT-VENT C/130A	K080952	BANDA-VENT	K080926
POLEA-ALT-VENT	36091	TENSOR-VENT	38569
TENSOR-ALT-VENT	38506	MANGUERA INFERIOR-TUBO A RAD.	24440
TERMOSTATO-190°	33579	POLEA-MOTOR	36091
TERMOSTATO-180°	33576	POLEA-MOTOR	36341
TERMOSTATO-180°	33578	BANDA-ALT-AA	K060635
TERMOSTATO-170°	33577	TERMOSTATO-190°	33579
2001		TERMOSTATO-180°	33576
BANDA-VENT-AA	K060547	TERMOSTATO-180°	33578
POLEA DEL TENSOR-VENT-AA	36091	TERMOSTATO-170°	33577
TENSOR-VENT-AA	38508	BOMBA DE AGUA-	44062HD
MANGUERA SILICÓN-TUBO A RAD.	SIH250363C	MANGUERA SUPERIOR-	21891
MANGUERA INFERIOR-MOTOR A TUBO	24452	2006	
MANGUERA SILICÓN-MOTOR A TUBO	SIH250363C	BANDA-VENT	K080926
BANDA-ALT-VENT	K080952	TENSOR-VENT	38569
POLEA-ALT-VENT	36091	MANGUERA INFERIOR-TUBO A RAD.	24440
TENSOR-ALT-VENT	38506	POLEA-MOTOR	36091
TERMOSTATO-190°	33579	POLEA-MOTOR	36341
TERMOSTATO-180°	33576	BANDA-ALT-AA	K060635
TERMOSTATO-180°	33578	TERMOSTATO-190°	33579
TERMOSTATO-170°	33577	TERMOSTATO-180°	33576
CATERPILLAR C15 DIESEL		TERMOSTATO-180°	33578
2009		TERMOSTATO-170°	33577
BANDA-VENT	K120985	BOMBA DE AGUA-	44062HD
TENSOR-ALT-VENT	38636	MANGUERA SUPERIOR-	21891
POLEA-AA INFERIOR	36282	2005	
BANDA-AA	K060723	BANDA-VENT-AA	K060635
TENSOR-AA	38609	POLEA DEL TENSOR-VENT-AA	36091
BOMBA DE AGUA-	44062HD	TENSOR-VENT-AA	38511
2008		MANGUERA SILICÓN-RAD. A TUBO	SIH250363C



MASTER SERVICIO PESADO 2014

FREIGHTLINER

COLUMBIA

MANGUERA SUPERIOR-RAD. A TUBO	21891	BANDA-ALT-VENT C/130A	K080952
MANGUERA SILICÓN-MOTOR A TUBO	SIH250363C	POLEA-ALT-VENT	36091
MANGUERA SILICÓN-MOTOR A RAD.	SIH250363C	TENSOR-ALT-VENT	38506
MANGUERA SUPERIOR-MOTOR A RAD.	CHARTER 2 1/2"	TERMOSTATO-190°	33579
POLEA-MOTOR	36091	TERMOSTATO-180°	33576
POLEA-MOTOR	36093	TERMOSTATO-180°	33578
BANDA-ALT-VENT	K080926	TERMOSTATO-170°	33577
TENSOR-ALT-VENT	38569	2001	
TERMOSTATO-190°	33579	BANDA-VENT-AA	K060547
TERMOSTATO-180°	33576	POLEA DEL TENSOR-VENT-AA	36091
TERMOSTATO-180°	33578	TENSOR-VENT-AA	38508
TERMOSTATO-170°	33577	MANGUERA SILICÓN-TUBO A RAD.	SIH250363C
MANGUERA INFERIOR-	CHARTER 2 1/2"	MANGUERA INFERIOR-MOTOR A TUBO	24452
2004		MANGUERA SILICÓN-MOTOR A TUBO	SIH250363C
POLEA-MOTOR	36091	BANDA-ALT-VENT	K080952
POLEA-MOTOR	36093	POLEA-ALT-VENT	36091
TERMOSTATO-190°	33579	TENSOR-ALT-VENT	38506
TERMOSTATO-180°	33576	TERMOSTATO-190°	33579
TERMOSTATO-180°	33578	TERMOSTATO-180°	33576
TERMOSTATO-170°	33577	TERMOSTATO-180°	33578
2003		TERMOSTATO-170°	33577
BANDA-VENT-AA	K060547	CATERPILLAR C13 DIESEL	
POLEA DEL TENSOR-VENT-AA	36091	2009	
TENSOR-VENT-AA	38508	MANGUERA SILICÓN-RAD. A TUBO	SIH250363C
MANGUERA SILICÓN-TUBO A RAD.	SIH250363C	MANGUERA SILICÓN-MOTOR A TUBO	SIH250363C
BANDA-TOMA DE FUERZA-ALT-AA C/ALT 135A	K080939	MANGUERA SUPERIOR-MOTOR A RAD.	22950
MANGUERA INFERIOR-MOTOR A TUBO	24452	POLEA-MOTOR	36269
MANGUERA SILICÓN-MOTOR A TUBO	SIH250363C	POLEA-MOTOR	36341
BANDA-ALT-VENT C/130A	K080944	BANDA-ALT-VENT-AA	K080952
POLEA-ALT-VENT	36091	TENSOR-ALT-VENT-AA	38590
TENSOR-ALT-VENT	38506	TERMOSTATO-190°	33579
TERMOSTATO-190°	33579	TERMOSTATO-180°	33576
TERMOSTATO-180°	33576	TERMOSTATO-180°	33578
TERMOSTATO-180°	33578	TERMOSTATO-170°	33577
TERMOSTATO-170°	33577	POLEA DEL TENSOR-	36164
2002		2008	
BANDA-VENT-AA	K060547	MANGUERA SILICÓN-RAD. A TUBO	SIH250363C
POLEA DEL TENSOR-VENT-AA	36091	MANGUERA SILICÓN-MOTOR A TUBO	SIH250363C
TENSOR-VENT-AA	38508	MANGUERA SUPERIOR-MOTOR A RAD.	22950
MANGUERA SILICÓN-TUBO A RAD.	SIH250363C	POLEA-MOTOR	36269
BANDA-TOMA DE FUERZA-ALT-AA C/ALT 135A	K080939	POLEA-MOTOR	36341
MANGUERA INFERIOR-MOTOR A TUBO	24452	BANDA-ALT-VENT-AA	K080952
MANGUERA SILICÓN-MOTOR A TUBO	SIH250363C	TENSOR-ALT-VENT-AA	38590



MASTER SERVICIO PESADO 2014

FREIGHTLINER

COLUMBIA

TERMOSTATO-190°	33579	POLEA-MOTOR	36093
TERMOSTATO-180°	33576	BANDA-ALT-VENT-AA	K080952
TERMOSTATO-180°	33578	TENSOR-ALT-VENT-AA	38590
TERMOSTATO-170°	33577	TERMOSTATO-190°	33579
POLEA DEL TENSOR-	36164	TERMOSTATO-180°	33576
2007		TERMOSTATO-180°	33578
MANGUERA SILICÓN-RAD. A TUBO	SIH250363C	TERMOSTATO-170°	33577
MANGUERA SILICÓN-MOTOR A TUBO	SIH250363C	CATERPILLAR C12 DIESEL	
MANGUERA SUPERIOR-MOTOR A RAD.	22950	2008	
POLEA-MOTOR	36093	TERMOSTATO-190°	33579
BANDA-ALT-VENT-AA	K080952	TERMOSTATO-180°	33576
TENSOR-ALT-VENT-AA	38590	TERMOSTATO-180°	33578
TERMOSTATO-190°	33579	TERMOSTATO-170°	33577
TERMOSTATO-180°	33576	2007	
TERMOSTATO-180°	33578	TERMOSTATO-190°	33579
TERMOSTATO-170°	33577	TERMOSTATO-180°	33576
2006		TERMOSTATO-180°	33578
MANGUERA INFERIOR-MOTOR A RAD.	22952	TERMOSTATO-170°	33577
MANGUERA SUPERIOR-MOTOR A RAD.	23086	2004	
POLEA-MOTOR	36093	BANDA-VENT-AA	K060525
BANDA-ALT-VENT-AA	K081005	POLEA DEL TENSOR-VENT-AA	36091
TENSOR-ALT-VENT-AA	38590	TENSOR-VENT-AA	38524
TERMOSTATO-190°	33579	POLEA DEL TENSOR-TOMA DE FUERZA-ALT-VENT	36091
TERMOSTATO-180°	33576	TENSOR-TOMA DE FUERZA-ALT-VENT	38506
TERMOSTATO-180°	33578	POLEA-ALT-VENT	36091
TERMOSTATO-170°	33577	TERMOSTATO-190°	33579
2005		TERMOSTATO-180°	33576
MANGUERA SILICÓN-RAD. A TUBO	SIH250363C	TERMOSTATO-180°	33578
MANGUERA SILICÓN-MOTOR A TUBO	SIH250363C	TERMOSTATO-170°	33577
MANGUERA SUPERIOR-MOTOR A TUBO	22950	2003	
POLEA-MOTOR	36093	BANDA-VENT-AA	K060523
BANDA-ALT-VENT-AA	K080952	POLEA DEL TENSOR-VENT-AA	36091
TENSOR-ALT-VENT-AA	38590	TENSOR-VENT-AA	38524
BANDA-ALT-BA-VENT	K080952	MANGUERA SILICÓN-TUBO A RAD.	SIH250363C
TERMOSTATO-190°	33579	MANGUERA SUPERIOR-TUBO A RAD.	21891
TERMOSTATO-180°	33576	POLEA DEL TENSOR-TOMA DE FUERZA-ALT-VENT	36091
TERMOSTATO-180°	33578	TENSOR-TOMA DE FUERZA-ALT-VENT	38506
TERMOSTATO-170°	33577	MANGUERA INFERIOR-MOTOR A TUBO	21891
MANGUERA INFERIOR-	CHARTER 2 1/2"	MANGUERA SUPERIOR-MOTOR A TUBO	21891
2004		POLEA-ALT-VENT	36091
MANGUERA SILICÓN-RAD. A TUBO	SIH250363C	TERMOSTATO-190°	33579
MANGUERA SILICÓN-MOTOR A TUBO	SIH250363C	TERMOSTATO-180°	33576
MANGUERA SUPERIOR-MOTOR A TUBO	22950	TERMOSTATO-180°	33578



MASTER SERVICIO PESADO 2014

FREIGHTLINER

COLUMBIA

TERMOSTATO-170°	33577	MANGUERA SUPERIOR-MOTOR A TUBO	22950
2002		POLEA-MOTOR	36093
POLEA-ALT-VENT	36091	BANDA-ALT-VENT-AA	K080952
TERMOSTATO-190°	33579	TENSOR-ALT-VENT-AA	38590
TERMOSTATO-180°	33576	TERMOSTATO-190°	33579
TERMOSTATO-180°	33578	TERMOSTATO-180°	33576
TERMOSTATO-170°	33577	TERMOSTATO-180°	33578
2001		TERMOSTATO-170°	33577
POLEA-ALT-VENT	36091	CATERPILLAR C10 DIESEL	
TERMOSTATO-190°	33579	2003	
TERMOSTATO-180°	33576	BANDA-VENT-AA	K060523
TERMOSTATO-180°	33578	POLEA DEL TENSOR-VENT-AA	36091
TERMOSTATO-170°	33577	TENSOR-VENT-AA	38524
CATERPILLAR C11 DIESEL		MANGUERA SILICÓN-TUBO A RAD.	SIH250363C
2007		MANGUERA SUPERIOR-TUBO A RAD.	21891
MANGUERA INFERIOR-MOTOR A RAD.	22952	POLEA DEL TENSOR-TOMA DE FUERZA-ALT-VENT	36091
MANGUERA SUPERIOR-MOTOR A RAD.	23086	TENSOR-TOMA DE FUERZA-ALT-VENT	38506
POLEA-MOTOR	36093	MANGUERA INFERIOR-MOTOR A TUBO	21891
BANDA-ALT-VENT-AA	K081005	MANGUERA SUPERIOR-MOTOR A TUBO	21891
TENSOR-ALT-VENT-AA	38590	POLEA-ALT-VENT	36091
TERMOSTATO-190°	33579	TERMOSTATO-190°	33579
TERMOSTATO-180°	33576	TERMOSTATO-180°	33576
TERMOSTATO-180°	33578	TERMOSTATO-180°	33578
TERMOSTATO-170°	33577	TERMOSTATO-170°	33577
2006		2002	
MANGUERA INFERIOR-MOTOR A RAD.	22952	BANDA-VENT-AA	K060523
MANGUERA SUPERIOR-MOTOR A RAD.	23086	POLEA DEL TENSOR-VENT-AA	36091
POLEA-MOTOR	36093	TENSOR-VENT-AA	38524
BANDA-ALT-VENT-AA	K081005	MANGUERA SILICÓN-TUBO A RAD.	SIH250363C
TENSOR-ALT-VENT-AA	38590	MANGUERA SUPERIOR-TUBO A RAD.	21891
TERMOSTATO-190°	33579	POLEA DEL TENSOR-TOMA DE FUERZA-ALT-VENT	36091
TERMOSTATO-180°	33576	TENSOR-TOMA DE FUERZA-ALT-VENT	38506
TERMOSTATO-180°	33578	MANGUERA INFERIOR-MOTOR A TUBO	21891
TERMOSTATO-170°	33577	MANGUERA SUPERIOR-MOTOR A TUBO	21891
2005		POLEA-ALT-VENT	36091
POLEA-MOTOR	36093	TERMOSTATO-190°	33579
TERMOSTATO-190°	33579	TERMOSTATO-180°	33576
TERMOSTATO-180°	33576	TERMOSTATO-180°	33578
TERMOSTATO-180°	33578	TERMOSTATO-170°	33577
TERMOSTATO-170°	33577	2001	
2004		BANDA-VENT-AA	K060523
MANGUERA SILICÓN-RAD. A TUBO	SIH250363C	POLEA DEL TENSOR-VENT-AA	36091
MANGUERA SILICÓN-MOTOR A TUBO	SIH250363C	TENSOR-VENT-AA	38524



MASTER SERVICIO PESADO 2014

FREIGHTLINER

COLUMBIA

MANGUERA SILICÓN-TUBO A RAD.	SIH250363C	MANGUERA INFERIOR-TUBOO A RAD.	24440
MANGUERA SUPERIOR-TUBO A RAD.	21891	MANGUERA SUPERIOR-TUBO A RAD.	24440
POLEA DEL TENSOR-TOMA DE FUERZA-ALT-VENT	36091	BANDA-TOMA DE FUERZA-ALT-AA	K080565
TENSOR-TOMA DE FUERZA-ALT-VENT	38506	POLEA-TOMA DE FUERZA-ALT-AA	38075
MANGUERA INFERIOR-MOTOR A TUBO	21891	TENSOR-TOMA DE FUERZA-ALT-AA	38501
MANGUERA SUPERIOR-MOTOR A TUBO	21891	MANGUERA INFERIOR-MOTOR A TUBO	24440
POLEA-ALT-VENT	36091	MANGUERA SUPERIOR-MOTOR A TUBO	21135
TERMOSTATO-190°	33579	2004	
TERMOSTATO-180°	33576	TENSOR-VENT	38503
TERMOSTATO-180°	33578	MANGUERA SUPERIOR-TUBO A RAD.	CHARTER 2 1/2"
TERMOSTATO-170°	33577	BANDA-TOMA DE FUERZA-ALT-AA	K080565
CATERPILLAR 3406 DIESEL		POLEA-TOMA DE FUERZA-ALT-AA	38075
2002		TENSOR-TOMA DE FUERZA-ALT-AA	38501
TERMOSTATO-190°	33579	MANGUERA SUPERIOR-MOTOR A TUBO	21135
TERMOSTATO-180°	33576	MANGUERA INFERIOR-	CHARTER 2 1/2"
TERMOSTATO-180°	33578	DETROIT DIESEL 6 CIL, 14.0 L DIESEL	
TERMOSTATO-170°	33577	2010	
2001		BANDA-VENT	K100502
TERMOSTATO-190°	33579	POLEA DEL TENSOR-VENT	38076
TERMOSTATO-180°	33576	TENSOR-VENT	38503
TERMOSTATO-180°	33578	MANGUERA SILICÓN-TUBO A RAD.	SIH250363C
TERMOSTATO-170°	33577	BANDA-TOMA DE FUERZA-ALT-AA	K080565
2000		POLEA DEL TENSOR-TOMA DE FUERZA-ALT-AA	38075
TERMOSTATO-190°	33579	TENSOR-TOMA DE FUERZA-ALT-AA	38501
TERMOSTATO-180°	33576	MANGUERA SILICÓN-MOTOR A TUBO	SIH250363C
TERMOSTATO-180°	33578	MANGUERA SUPERIOR-MOTOR A TUBO	21135
TERMOSTATO-170°	33577	TERMOSTATO-190°	33599
CORONADO		2009	
DETROIT DIESEL SERIE 60		BANDA-VENT	K100502
2006		POLEA DEL TENSOR-VENT	38076
BANDA-VENT	K100502	TENSOR-VENT	38503
POLEA-VENT	38076	MANGUERA SILICÓN-TUBO A RAD.	SIH250363C
TENSOR-VENT	38503	BANDA-TOMA DE FUERZA-ALT-AA	K080565
MANGUERA SUPERIOR-TUBO A RAD.	CHARTER 2 1/2"	POLEA DEL TENSOR-TOMA DE FUERZA-ALT-AA	38075
BANDA-TOMA DE FUERZA-ALT-AA	K080565	TENSOR-TOMA DE FUERZA-ALT-AA	38501
POLEA-TOMA DE FUERZA-ALT-AA	38075	MANGUERA SILICÓN-MOTOR A TUBO	SIH250363C
TENSOR-TOMA DE FUERZA-ALT-AA	38501	MANGUERA SUPERIOR-MOTOR A TUBO	21135
MANGUERA SUPERIOR-MOTOR A TUBO	21135	TERMOSTATO-190°	33599
MANGUERA INFERIOR-	CHARTER 2 1/2"	2008	
2005		BANDA-VENT	K100502
BANDA-VENT	K100502	POLEA DEL TENSOR-VENT	38076
POLEA-VENT	38076	TENSOR-VENT	38503
TENSOR-VENT	38503	MANGUERA SILICÓN-TUBO A RAD.	SIH250363C



MASTER SERVICIO PESADO 2014

FREIGHTLINER

CORONADO

BANDA-TOMA DE FUERZA-ALT-AA	K080565	MANGUERA SILICÓN-TUBO A RAD.	SIH250363C
POLEA DEL TENSOR-TOMA DE FUERZA-ALT-AA	38075	BANDA-TOMA DE FUERZA-ALT-AA	K080565
TENSOR-TOMA DE FUERZA-ALT-AA	38501	POLEA DEL TENSOR-TOMA DE FUERZA-ALT-AA	38075
MANGUERA SILICÓN-MOTOR A TUBO	SIH250363C	TENSOR-TOMA DE FUERZA-ALT-AA	38501
MANGUERA SUPERIOR-MOTOR A TUBO	21135	MANGUERA SILICÓN-MOTOR A TUBO	SIH250363C
TERMOSTATO-190°	33599	MANGUERA SUPERIOR-MOTOR A TUBO	21135
2007		TERMOSTATO-190°	33599
BANDA-VENT	K100502	2003	
POLEA DEL TENSOR-VENT	38076	BANDA-VENT	K100579
TENSOR-VENT	38503	POLEA DEL TENSOR-VENT	38076
MANGUERA SILICÓN-TUBO A RAD.	SIH250363C	TENSOR-VENT	38503
BANDA-TOMA DE FUERZA-ALT-AA	K080565	MANGUERA INFERIOR-TUBO A RAD.	CHARTER 2 1/2"
POLEA DEL TENSOR-TOMA DE FUERZA-ALT-AA	38075	MANGUERA SUPERIOR-TUBO A RAD.	CHARTER 2 1/2"
TENSOR-TOMA DE FUERZA-ALT-AA	38501	BANDA-TOMA DE FUERZA-ALT-AA	K080565
MANGUERA SILICÓN-MOTOR A TUBO	SIH250363C	POLEA DEL TENSOR-TOMA DE FUERZA-ALT-AA	38075
MANGUERA SUPERIOR-MOTOR A TUBO	21135	TENSOR-TOMA DE FUERZA-ALT-AA	38501
TERMOSTATO-190°	33599	MANGUERA SUPERIOR-MOTOR A TUBO	CHARTER 2 1/2"
2006		TERMOSTATO-190°	33599
BANDA-VENT	K100502	DETROIT DIESEL 6 CIL, 12.7 L DIESEL	
POLEA DEL TENSOR-VENT	38076	2008	
TENSOR-VENT	38503	BANDA-VENT	K100502
MANGUERA SILICÓN-TUBO A RAD.	SIH250363C	POLEA DEL TENSOR-VENT	38076
BANDA-TOMA DE FUERZA-ALT-AA	K080565	TENSOR-VENT	38503
POLEA DEL TENSOR-TOMA DE FUERZA-ALT-AA	38075	MANGUERA SILICÓN-TUBO A RAD.	SIH250363C
TENSOR-TOMA DE FUERZA-ALT-AA	38501	BANDA-TOMA DE FUERZA-ALT-AA	K080565
MANGUERA SILICÓN-MOTOR A TUBO	SIH250363C	POLEA DEL TENSOR-TOMA DE FUERZA-ALT-AA	38075
MANGUERA SUPERIOR-MOTOR A TUBO	21135	TENSOR-TOMA DE FUERZA-ALT-AA	38501
TERMOSTATO-190°	33599	MANGUERA SILICÓN-MOTOR A TUBO	SIH250363C
2005		MANGUERA SUPERIOR-MOTOR A TUBO	21135
BANDA-VENT	K100502	TERMOSTATO-190°	33599
POLEA DEL TENSOR-VENT	38076	2007	
TENSOR-VENT	38503	BANDA-VENT	K100502
MANGUERA SILICÓN-TUBO A RAD.	SIH250363C	POLEA DEL TENSOR-VENT	38076
BANDA-TOMA DE FUERZA-ALT-AA	K080565	TENSOR-VENT	38503
POLEA DEL TENSOR-TOMA DE FUERZA-ALT-AA	38075	MANGUERA SILICÓN-TUBO A RAD.	SIH250363C
TENSOR-TOMA DE FUERZA-ALT-AA	38501	BANDA-TOMA DE FUERZA-ALT-AA	K080565
MANGUERA SILICÓN-MOTOR A TUBO	SIH250363C	POLEA DEL TENSOR-TOMA DE FUERZA-ALT-AA	38075
MANGUERA SUPERIOR-MOTOR A TUBO	21135	TENSOR-TOMA DE FUERZA-ALT-AA	38501
TERMOSTATO-190°	33599	MANGUERA SILICÓN-MOTOR A TUBO	SIH250363C
2004		MANGUERA SUPERIOR-MOTOR A TUBO	21135
BANDA-VENT	K100502	TERMOSTATO-190°	33599
POLEA DEL TENSOR-VENT	38076	2006	
TENSOR-VENT	38503	BANDA-VENT	K100502



MASTER SERVICIO PESADO 2014

FREIGHTLINER

CORONADO

POLEA DEL TENSOR-VENT	38076	BANDA-VENT	K100579
TENSOR-VENT	38503	POLEA DEL TENSOR-VENT	38076
MANGUERA SILICÓN-TUBO A RAD.	SIH250363C	TENSOR-VENT	38503
BANDA-TOMA DE FUERZA-ALT-AA	K080565	MANGUERA INFERIOR-TUBO A RAD.	CHARTER 2 1/2"
POLEA DEL TENSOR-TOMA DE FUERZA-ALT-AA	38075	MANGUERA SUPERIOR-TUBO A RAD.	CHARTER 2 1/2"
TENSOR-TOMA DE FUERZA-ALT-AA	38501	BANDA-TOMA DE FUERZA-ALT-AA	K080565
MANGUERA SILICÓN-MOTOR A TUBO	SIH250363C	POLEA DEL TENSOR-TOMA DE FUERZA-ALT-AA	38075
MANGUERA SUPERIOR-MOTOR A TUBO	21135	TENSOR-TOMA DE FUERZA-ALT-AA	38501
TERMOSTATO-190°	33599	MANGUERA SUPERIOR-MOTOR A TUBO	CHARTER 2 1/2"
2005		TERMOSTATO-190°	33599
BANDA-VENT	K100502	CATERPILLAR C16 DIESEL	
POLEA DEL TENSOR-VENT	38076	2003	
TENSOR-VENT	38503	BANDA-VENT-AA	K060547
MANGUERA SILICÓN-TUBO A RAD.	SIH250363C	POLEA DEL TENSOR-VENT-AA	36091
BANDA-TOMA DE FUERZA-ALT-AA	K080565	TENSOR-VENT-AA	38508
POLEA DEL TENSOR-TOMA DE FUERZA-ALT-AA	38075	MANGUERA INFERIOR-TUBO A RAD.	CHARTER 2 1/2"
TENSOR-TOMA DE FUERZA-ALT-AA	38501	MANGUERA SUPERIOR-TUBO A RAD.	CHARTER 2 1/2"
MANGUERA SILICÓN-MOTOR A TUBO	SIH250363C	BANDA-TOMA DE FUERZA-ALT-AA C/ALT 135A	K080939
MANGUERA SUPERIOR-MOTOR A TUBO	21135	MANGUERA INFERIOR-MOTOR A TUBO	21891
TERMOSTATO-190°	33599	MANGUERA SUPERIOR-MOTOR A TUBO	21891
2004		BANDA-ALT-VENT C/130A	K080952
BANDA-VENT	K100502	POLEA-ALT-VENT	36091
POLEA DEL TENSOR-VENT	38076	TENSOR-ALT-VENT	38506
TENSOR-VENT	38503	TERMOSTATO-190°	33579
MANGUERA SILICÓN-TUBO A RAD.	SIH250363C	TERMOSTATO-180°	33576
BANDA-TOMA DE FUERZA-ALT-AA	K080565	TERMOSTATO-180°	33578
POLEA DEL TENSOR-TOMA DE FUERZA-ALT-AA	38075	TERMOSTATO-170°	33577
TENSOR-TOMA DE FUERZA-ALT-AA	38501	2002	
MANGUERA SILICÓN-MOTOR A TUBO	SIH250363C	BANDA-VENT-AA	K060547
MANGUERA SUPERIOR-MOTOR A TUBO	21135	POLEA DEL TENSOR-VENT-AA	36091
TERMOSTATO-190°	33599	TENSOR-VENT-AA	38508
2003		MANGUERA INFERIOR-TUBO A RAD.	CHARTER 2 1/2"
BANDA-VENT	K100579	MANGUERA SUPERIOR-TUBO A RAD.	CHARTER 2 1/2"
POLEA DEL TENSOR-VENT	38076	BANDA-TOMA DE FUERZA-ALT-AA C/ALT 135A	K080939
TENSOR-VENT	38503	MANGUERA INFERIOR-MOTOR A TUBO	21891
MANGUERA INFERIOR-TUBO A RAD.	CHARTER 2 1/2"	MANGUERA SUPERIOR-MOTOR A TUBO	21891
MANGUERA SUPERIOR-TUBO A RAD.	CHARTER 2 1/2"	BANDA-ALT-VENT C/130A	K080952
BANDA-TOMA DE FUERZA-ALT-AA	K080565	POLEA-ALT-VENT	36091
POLEA DEL TENSOR-TOMA DE FUERZA-ALT-AA	38075	TENSOR-ALT-VENT	38506
TENSOR-TOMA DE FUERZA-ALT-AA	38501	TERMOSTATO-190°	33579
MANGUERA SUPERIOR-MOTOR A TUBO	CHARTER 2 1/2"	TERMOSTATO-180°	33576
TERMOSTATO-190°	33599	TERMOSTATO-180°	33578
2002		TERMOSTATO-170°	33577



MASTER SERVICIO PESADO 2014

FREIGHTLINER

CORONADO

CATERPILLAR C15 DIESEL

2008

MANGUERA INFERIOR-RAD. A TUBO	21891
TERMOSTATO-190°	33579
TERMOSTATO-180°	33576
TERMOSTATO-180°	33578
TERMOSTATO-170°	33577

2007

POLEA-MOTOR	36091
POLEA-MOTOR	36093
TERMOSTATO-190°	33579
TERMOSTATO-180°	33576
TERMOSTATO-180°	33578
TERMOSTATO-170°	33577

2006

BANDA-VENT-AA	K060586
POLEA DEL TENSOR-VENT-AA	36091
TENSOR-VENT-AA	38511
MANGUERA SILICÓN-RAD. A TUBO	SIH250363C
MANGUERA SUPERIOR-MOTOR A TUBO	21891
MANGUERA INFERIOR-MOTOR A RAD.	23084
POLEA-MOTOR	36091
POLEA-MOTOR	36093
BANDA-ALT-VENT	K080926
TENSOR-ALT-VENT	38569
TERMOSTATO-190°	33579
TERMOSTATO-180°	33576
TERMOSTATO-180°	33578
TERMOSTATO-170°	33577

2005

BANDA-VENT-AA	K060586
POLEA DEL TENSOR-VENT-AA	36091
TENSOR-VENT-AA	38511
MANGUERA SILICÓN-RAD. A TUBO	SIH250363C
MANGUERA SUPERIOR-MOTOR A TUBO	21891
MANGUERA INFERIOR-MOTOR A RAD.	23084
POLEA-MOTOR	36091
POLEA-MOTOR	36093
BANDA-ALT-VENT	K080926
TENSOR-ALT-VENT	38569
TERMOSTATO-190°	33579
TERMOSTATO-180°	33576
TERMOSTATO-180°	33578

TERMOSTATO-170°

33577

2004

BANDA-VENT-AA	K060547
POLEA DEL TENSOR-VENT-AA	36091
TENSOR-VENT-AA	38508
MANGUERA INFERIOR-TUBO A RAD.	CHARTER 2 1/2"
MANGUERA SUPERIOR-TUBO A RAD.	CHARTER 2 1/2"
BANDA-TOMA DE FUERZA-ALT-AA C/ALT 135A	K080939
MANGUERA INFERIOR-MOTOR A TUBO	21891
MANGUERA SUPERIOR-MOTOR A TUBO	21891
POLEA-MOTOR	36091
POLEA-MOTOR	36093
BANDA-ALT-VENT C/130A	K080952
POLEA-ALT-VENT	36091
TENSOR-ALT-VENT	38506
TERMOSTATO-190°	33579
TERMOSTATO-180°	33576
TERMOSTATO-180°	33578
TERMOSTATO-170°	33577

2003

BANDA-VENT-AA	K060547
POLEA DEL TENSOR-VENT-AA	36091
TENSOR-VENT-AA	38508
MANGUERA INFERIOR-TUBO A RAD.	CHARTER 2 1/2"
MANGUERA SUPERIOR-TUBO A RAD.	CHARTER 2 1/2"
BANDA-TOMA DE FUERZA-ALT-AA C/ALT 135A	K080939
MANGUERA INFERIOR-MOTOR A TUBO	21891
MANGUERA SUPERIOR-MOTOR A TUBO	21891
BANDA-ALT-VENT C/130A	K080952
POLEA-ALT-VENT	36091
TENSOR-ALT-VENT	38506
TERMOSTATO-190°	33579
TERMOSTATO-180°	33576
TERMOSTATO-180°	33578
TERMOSTATO-170°	33577

2002

BANDA-VENT-AA	K060547
POLEA DEL TENSOR-VENT-AA	36091
TENSOR-VENT-AA	38508
MANGUERA INFERIOR-TUBO A RAD.	CHARTER 2 1/2"
MANGUERA SUPERIOR-TUBO A RAD.	CHARTER 2 1/2"
BANDA-TOMA DE FUERZA-ALT-AA C/ALT 135A	K080939
MANGUERA INFERIOR-MOTOR A TUBO	21891



MANGUERA SUPERIOR-MOTOR A TUBO	21891	BANDA-VENT	K060470
BANDA-ALT-VENT C/130A	K080952	1997	
POLEA-ALT-VENT	36091	BANDA-VENT	K060470
TENSOR-ALT-VENT	38506	MANGUERA INFERIOR-	CHARTER 2 1/2"
TERMOSTATO-190°	33579	MANGUERA SUPERIOR-	CHARTER 2 1/2"
TERMOSTATO-180°	33576	1996	
TERMOSTATO-180°	33578	MANGUERA INFERIOR-	CHARTER 2 1/2"
TERMOSTATO-170°	33577	MANGUERA SUPERIOR-	CHARTER 2 1/2"

FL112**MERCEDES-BENZ MBE 4000 DIESEL****2004**

BANDA-VENT	K080672
MANGUERA SILICÓN-TUBO A RAD.	SIH250363C
BANDA-TOMA DE FUERZA-ALT	K090609
TENSOR-TOMA DE FUERZA-ALT	38541
MANGUERA INFERIOR-MOTOR A TUBO	21891
MANGUERA SILICÓN-MOTOR A TUBO	SIH250363C
BANDA-AA	K060439
TENSOR-AA	38540

2003

BANDA-VENT	K080672
MANGUERA SILICÓN-TUBO A RAD.	SIH250363C
BANDA-TOMA DE FUERZA-ALT	K090609
TENSOR-TOMA DE FUERZA-ALT	38541
MANGUERA INFERIOR-MOTOR A TUBO	21891
MANGUERA SILICÓN-MOTOR A TUBO	SIH250363C
BANDA-AA	K060439
TENSOR-AA	38540

DETROIT DIESEL SERIES 55 DIESEL**1998**

BANDA-VENT	K060470
TERMOSTATO-190°	33599

1997

BANDA-VENT	K060470
TERMOSTATO-190°	33599
MANGUERA SILICÓN-	SIH250363C

DETROIT DIESEL SERIES 50 DIESEL**1998**

TERMOSTATO-190°	33599
-----------------	-------

1997

TERMOSTATO-190°	33599
-----------------	-------

DETROIT DIESEL SERIE 55**1998****DETROIT DIESEL SERIE 50****1999**

TENSOR-	38505
---------	-------

CUMMINS M11 DIESEL**1997**

BANDA-VENT	K080496
MANGUERA SILICÓN-TUBO A RAD.	SIH250363C
MANGUERA SUPERIOR-MOTOR A TUBO	24436
BANDA-ALT	K050345
TERMOSTATO-190°	33579
TERMOSTATO-180°	33576
TERMOSTATO-180°	33578
TERMOSTATO-170°	33577
BANDA-	9545
MANGUERA DE PASO-	CHARTER 1 3/4"
MANGUERA SILICÓN-	SIH250363C

1996

BANDA-VENT	K080496
MANGUERA SILICÓN-TUBO A RAD.	SIH250363C
MANGUERA SUPERIOR-MOTOR A TUBO	24436
BANDA-ALT	K050345
TERMOSTATO-190°	33579
TERMOSTATO-180°	33576
TERMOSTATO-180°	33578
TERMOSTATO-170°	33577
BANDA-	9545
MANGUERA DE PASO-	CHARTER 1 3/4"
MANGUERA SILICÓN-	SIH250363C

CUMMINS ISM DIESEL**2003**

MANGUERA SILICÓN-TUBO A RAD.	SIH250363C
MANGUERA SUPERIOR-TUBO A RAD.	CHARTER 2 1/2"
BANDA-TOMA DE FUERZA-AA	K060559
TENSOR-TOMA DE FUERZA-AA	38505
MANGUERA SILICÓN-MOTOR A TUBO	SIH250363C



MASTER SERVICIO PESADO 2014

FREIGHTLINER

FL112

MANGUERA SUPERIOR-MOTOR A TUBO	CHARTER 2 1/2"	MANGUERA SUPERIOR-MOTOR A TUBO	24436
BANDA-ALT-VENT	K080730	MANGUERA DE PASO-	CHARTER 1 3/4"
TENSOR-ALT-VENT	38521	POLEA DEL TENSOR-	36091
MANGUERA INFERIOR-	CHARTER 2 1/2"	1998	
POLEA DEL TENSOR-	36091	BANDA-VENT	K080491
2002		MANGUERA SUPERIOR-TUBO A RAD.	24436
MANGUERA SILICÓN-TUBO A RAD.	SIH250363C	BANDA-TOMA DE FUERZA-AA	9545
MANGUERA SUPERIOR-TUBO A RAD.	CHARTER 2 1/2"	MANGUERA SILICÓN-MOTOR A TUBO	SIH250363C
BANDA-TOMA DE FUERZA-AA	K060559	MANGUERA SUPERIOR-MOTOR A TUBO	24436
TENSOR-TOMA DE FUERZA-AA	38505	MANGUERA INFERIOR-MOTOR A RAD.	24436
MANGUERA SILICÓN-MOTOR A TUBO	SIH250363C	BANDA-ALT-BA	K050345
MANGUERA SUPERIOR-MOTOR A TUBO	CHARTER 2 1/2"	MANGUERA DE PASO-	CHARTER 1 3/4"
BANDA-ALT-VENT	K080730	CATERPILLAR C12 DIESEL	
TENSOR-ALT-VENT	38521	2004	
MANGUERA INFERIOR-	CHARTER 2 1/2"	BANDA-VENT-AA	K060523
POLEA DEL TENSOR-	36091	POLEA DEL TENSOR-VENT-AA	36091
2001		TENSOR-VENT-AA	38524
MANGUERA INFERIOR-TUBO A RAD.	21891	POLEA DEL TENSOR-TOMA DE FUERZA-ALT-VENT	36091
MANGUERA SILICÓN-TUBO A RAD.	SIH250363C	TENSOR-TOMA DE FUERZA-ALT-VENT	38506
BANDA-TOMA DE FUERZA-AA	K060559	POLEA-ALT-VENT	36091
TENSOR-TOMA DE FUERZA-AA	38505	TERMOSTATO-190°	33579
MANGUERA SILICÓN-MOTOR A TUBO	SIH250363C	TERMOSTATO-180°	33576
MANGUERA SUPERIOR-MOTOR A TUBO	24436	TERMOSTATO-180°	33578
BANDA-ALT-VENT	K080730	TERMOSTATO-170°	33577
TENSOR-ALT-VENT	38521	2003	
POLEA DEL TENSOR-	36091	BANDA-VENT-AA	K060529
2000		POLEA DEL TENSOR-VENT-AA	36091
MANGUERA SILICÓN-TUBO A RAD.	SIH250363C	TENSOR-VENT-AA	38524
BANDA-TOMA DE FUERZA-AA	K060559	MANGUERA INFERIOR-TUBO A RAD.	CHARTER 2 1/2"
TENSOR-TOMA DE FUERZA-AA	38505	MANGUERA SUPERIOR-TUBO A RAD.	CHARTER 2 1/2"
MANGUERA SILICÓN-MOTOR A TUBO	SIH250363C	BANDA-TOMA DE FUERZA-ALT-VENT	K080872
MANGUERA SUPERIOR-MOTOR A TUBO	24436	POLEA DEL TENSOR-TOMA DE FUERZA-ALT-VENT	36091
BANDA-ALT-VENT C/ALT 130A LEECE NEVILLE	K080785	TENSOR-TOMA DE FUERZA-ALT-VENT	38506
BANDA-ALT-VENT C/ALT 130A DELCO	K080730	MANGUERA INFERIOR-MOTOR A TUBO	21891
TENSOR-ALT-VENT	38521	MANGUERA SUPERIOR-MOTOR A TUBO	21891
POLEA DEL TENSOR-	36091	POLEA-ALT-VENT	36091
1999		TERMOSTATO-190°	33579
BANDA-VENT	K080530	TERMOSTATO-180°	33576
MANGUERA SILICÓN-TUBO A RAD.	SIH250363C	TERMOSTATO-180°	33578
BANDA-TOMA DE FUERZA-ALT	K050345	TERMOSTATO-170°	33577
BANDA-TOMA DE FUERZA-AA	K060523	2002	
TENSOR-TOMA DE FUERZA-AA	38505	BANDA-VENT-AA	K060529
MANGUERA SILICÓN-MOTOR A TUBO	SIH250363C	POLEA DEL TENSOR-VENT-AA	36091



MASTER SERVICIO PESADO 2014

FREIGHTLINER

FL112

TENSOR-VENT-AA	38524	TERMOSTATO-180°	33576
MANGUERA INFERIOR-TUBO A RAD.	21891	TERMOSTATO-180°	33578
MANGUERA SUPERIOR-TUBO A RAD.	CHARTER 2 1/2"	TERMOSTATO-170°	33577
BANDA-TOMA DE FUERZA-ALT-VENT	K080855	1999	
POLEA DEL TENSOR-TOMA DE FUERZA-ALT-VENT	36091	BANDA-VENT-AA	K060523
TENSOR-TOMA DE FUERZA-ALT-VENT	38506	TENSOR-VENT-AA	38534
MANGUERA INFERIOR-MOTOR A TUBO	21891	MANGUERA SILICÓN-TUBO A RAD.	SIH250363C
MANGUERA SUPERIOR-MOTOR A TUBO	21891	MANGUERA INFERIOR-MOTOR A TUBO	21194
POLEA-ALT-VENT	36091	BANDA-ALT-VENT	K080855
TERMOSTATO-190°	33579	POLEA-ALT-VENT	36091
TERMOSTATO-180°	33576	TENSOR-ALT-VENT	38506
TERMOSTATO-180°	33578	POLEA DEL TENSOR-ALT-AA	38092
TERMOSTATO-170°	33577	TERMOSTATO-190°	33579
2001		TERMOSTATO-180°	33576
BANDA-VENT-AA	K060529	TERMOSTATO-180°	33578
POLEA DEL TENSOR-VENT-AA	36091	TERMOSTATO-170°	33577
TENSOR-VENT-AA	38524	1998	
MANGUERA INFERIOR-TUBO A RAD.	21891	TERMOSTATO-190°	33579
MANGUERA SILICÓN-TUBO A RAD.	SIH250363C	TERMOSTATO-180°	33576
BANDA-TOMA DE FUERZA-ALT-VENT	K080855	TERMOSTATO-180°	33578
POLEA DEL TENSOR-TOMA DE FUERZA-ALT-VENT	36091	TERMOSTATO-170°	33577
TENSOR-TOMA DE FUERZA-ALT-VENT	38506	1997	
MANGUERA INFERIOR-MOTOR A TUBO	21891	TERMOSTATO-190°	33579
MANGUERA SUPERIOR-MOTOR A TUBO	21891	TERMOSTATO-180°	33576
POLEA-ALT-VENT	36091	TERMOSTATO-180°	33578
TERMOSTATO-190°	33579	TERMOSTATO-170°	33577
TERMOSTATO-180°	33576	CATERPILLAR C10 DIESEL	
TERMOSTATO-180°	33578	2004	
TERMOSTATO-170°	33577	BANDA-VENT-AA	K060529
2000		POLEA DEL TENSOR-VENT-AA	36091
BANDA-VENT-AA	9500	TENSOR-VENT-AA	38524
BANDA-VENT-AA	K060523	MANGUERA INFERIOR-TUBO A RAD.	CHARTER 2 1/2"
TENSOR-VENT-AA	38534	MANGUERA SUPERIOR-TUBO A RAD.	CHARTER 2 1/2"
MANGUERA SILICÓN-TUBO A RAD.	SIH250363C	BANDA-TOMA DE FUERZA-ALT-VENT	K080872
BANDA-TOMA DE FUERZA-ALT-VENT	K080855	POLEA DEL TENSOR-TOMA DE FUERZA-ALT-VENT	36091
POLEA DEL TENSOR-TOMA DE FUERZA-ALT-VENT	36091	TENSOR-TOMA DE FUERZA-ALT-VENT	38506
TENSOR-TOMA DE FUERZA-ALT-VENT	38506	MANGUERA INFERIOR-MOTOR A TUBO	21891
MANGUERA INFERIOR-MOTOR A TUBO	21891	MANGUERA SUPERIOR-MOTOR A TUBO	21891
MANGUERA SUPERIOR-MOTOR A TUBO	21891	POLEA-ALT-VENT	36091
POLEA-ALT-VENT	36091	TERMOSTATO-190°	33579
POLEA DEL TENSOR-ALT-AA	38092	TERMOSTATO-180°	33576
TERMOSTATO-190°	33579	TERMOSTATO-180°	33578
		TERMOSTATO-170°	33577



MASTER SERVICIO PESADO 2014

FREIGHTLINER

FL112

2003			MANGUERA SUPERIOR-MOTOR A TUBO	21891
BANDA-VENT-AA	K060529		POLEA-ALT-VENT	36091
POLEA DEL TENSOR-VENT-AA	36091		TERMOSTATO-190°	33579
TENSOR-VENT-AA	38524		TERMOSTATO-180°	33576
MANGUERA INFERIOR-TUBO A RAD.	CHARTER 2 1/2"		TERMOSTATO-180°	33578
MANGUERA SUPERIOR-TUBO A RAD.	CHARTER 2 1/2"		TERMOSTATO-170°	33577
BANDA-TOMA DE FUERZA-ALT-VENT	K080872	2000		
POLEA DEL TENSOR-TOMA DE FUERZA-ALT-VENT	36091		BANDA-VENT-AA	9500
TENSOR-TOMA DE FUERZA-ALT-VENT	38506		BANDA-VENT-AA	K060523
MANGUERA INFERIOR-MOTOR A TUBO	21891		TENSOR-VENT-AA	38534
MANGUERA SUPERIOR-MOTOR A TUBO	21891		MANGUERA SILICÓN-TUBO A RAD.	SIH250363C
POLEA-ALT-VENT	36091		BANDA-TOMA DE FUERZA-ALT-VENT	K080855
TERMOSTATO-190°	33579		POLEA DEL TENSOR-TOMA DE FUERZA-ALT-VENT	36091
TERMOSTATO-180°	33576		TENSOR-TOMA DE FUERZA-ALT-VENT	38506
TERMOSTATO-180°	33578		MANGUERA INFERIOR-MOTOR A TUBO	21891
TERMOSTATO-170°	33577		MANGUERA SUPERIOR-MOTOR A TUBO	21891
2002			POLEA-ALT-VENT	36091
BANDA-VENT-AA	K060529		POLEA DEL TENSOR-ALT-AA	38092
POLEA DEL TENSOR-VENT-AA	36091		TERMOSTATO-190°	33579
TENSOR-VENT-AA	38524		TERMOSTATO-180°	33576
MANGUERA INFERIOR-TUBO A RAD.	21891		TERMOSTATO-180°	33578
MANGUERA SUPERIOR-TUBO A RAD.	CHARTER 2 1/2"		TERMOSTATO-170°	33577
MANGUERA INFERIOR-TUBO A ENFRIADOR	21891	1999		
BANDA-TOMA DE FUERZA-ALT-VENT	K080855		BANDA-VENT-AA	K060523
POLEA DEL TENSOR-TOMA DE FUERZA-ALT-VENT	36091		TENSOR-VENT-AA	38534
TENSOR-TOMA DE FUERZA-ALT-VENT	38506		MANGUERA SILICÓN-TUBO A RAD.	SIH250363C
MANGUERA INFERIOR-MOTOR A TUBO	21891		MANGUERA SUPERIOR-MOTOR A TUBO	21194
MANGUERA SUPERIOR-MOTOR A TUBO	21891		BANDA-ALT-VENT	K080855
POLEA-ALT-VENT	36091		POLEA-ALT-VENT	36091
TERMOSTATO-190°	33579		TENSOR-ALT-VENT	38506
TERMOSTATO-180°	33576		POLEA DEL TENSOR-ALT-AA	38092
TERMOSTATO-180°	33578		TERMOSTATO-190°	33579
TERMOSTATO-170°	33577		TERMOSTATO-180°	33576
2001			TERMOSTATO-180°	33578
BANDA-VENT-AA	K060529		TERMOSTATO-170°	33577
POLEA DEL TENSOR-VENT-AA	36091	1998		
TENSOR-VENT-AA	38524		TERMOSTATO-190°	33579
MANGUERA INFERIOR-TUBO A RAD.	21891		TERMOSTATO-180°	33576
MANGUERA SILICÓN-TUBO A RAD.	SIH250363C		TERMOSTATO-180°	33578
BANDA-TOMA DE FUERZA-ALT-VENT	K080855		TERMOSTATO-170°	33577
POLEA DEL TENSOR-TOMA DE FUERZA-ALT-VENT	36091	1997		
TENSOR-TOMA DE FUERZA-ALT-VENT	38506		TERMOSTATO-190°	33579
MANGUERA INFERIOR-MOTOR A TUBO	21891		TERMOSTATO-180°	33576



TERMOSTATO-180°	33578	MANGUERA DE PASO-	CHARTER 1 3/4"
TERMOSTATO-170°	33577	MANGUERA DE PASO-	CHARTER 3"
FLC			
DETROIT DIESEL SERIE 60			
1997		1991	
BANDA-VENT	PQ17500	MANGUERA INFERIOR-TUBO A RAD.	21472
BANDA-VENT	PQ17510	MANGUERA DE CALEFACCIÓN-	35B 5/8"
MANGUERA INFERIOR-TUBO A RAD.	21472	MANGUERA DE CALEFACCIÓN-	CHARTER 3/4"
BANDA-ALT	2/9510PB	MANGUERA DE PASO-	CHARTER 1 3/4"
MANGUERA DE CALEFACCIÓN-	35B 5/8"	MANGUERA DE PASO-	CHARTER 3"
MANGUERA DE CALEFACCIÓN-	CHARTER 3/4"	MANGUERA INFERIOR-	CHARTER 2 1/2"
MANGUERA DE PASO-	CHARTER 1 3/4"	MANGUERA SUPERIOR-	CHARTER 2 1/2"
MANGUERA DE PASO-	CHARTER 3"	1990	
MANGUERA INFERIOR-	CHARTER 2 1/2"	BANDA-VENT	8600 GS
MANGUERA SUPERIOR-	CHARTER 2 1/2"	MANGUERA INFERIOR-TUBO A RAD.	21472
1995		BANDA-ALT PRESTOLITE	2/9555PB
MANGUERA INFERIOR-TUBO A RAD.	21472	BANDA-ALT DELCO	2/9500PB
MANGUERA DE CALEFACCIÓN-	35B 5/8"	BANDA-ALT DELCO	2/9545PB
MANGUERA DE CALEFACCIÓN-	CHARTER 3/4"	BANDA-ALT DELCO	PQ17550
MANGUERA DE PASO-	CHARTER 1 3/4"	BANDA-ALT	2/9510PB
MANGUERA DE PASO-	CHARTER 3"	BANDA-AA	PQ17510
MANGUERA INFERIOR-	CHARTER 2 1/2"	MANGUERA DE CALEFACCIÓN-	35B 5/8"
MANGUERA SUPERIOR-	CHARTER 2 1/2"	MANGUERA DE CALEFACCIÓN-	CHARTER 3/4"
1994		MANGUERA DE PASO-	CHARTER 1 3/4"
MANGUERA INFERIOR-TUBO A RAD.	21472	MANGUERA DE PASO-	CHARTER 3"
MANGUERA DE CALEFACCIÓN-	35B 5/8"	MANGUERA INFERIOR-	CHARTER 2 1/2"
MANGUERA DE CALEFACCIÓN-	CHARTER 3/4"	MANGUERA SUPERIOR-	CHARTER 2 1/2"
MANGUERA DE PASO-	CHARTER 1 3/4"	DETROIT DIESEL 6 CIL, 12.7 L DIESEL	
MANGUERA DE PASO-	CHARTER 3"	1998	
MANGUERA INFERIOR-	CHARTER 2 1/2"	BANDA-VENT- OPCIONAL	9500
MANGUERA SUPERIOR-	CHARTER 2 1/2"	BANDA-VENT	3/9500PB
1993		BANDA-VENT	9510
MANGUERA INFERIOR-TUBO A RAD.	21472	MANGUERA INFERIOR-TUBO A RAD.	21472
MANGUERA DE CALEFACCIÓN-	35B 5/8"	MANGUERA SILICÓN-ENTRADA A BA	SIH300363C
MANGUERA DE CALEFACCIÓN-	CHARTER 3/4"	BANDA-ALT	2/9510PB
MANGUERA DE PASO-	CHARTER 1 3/4"	TERMOSTATO-190°	33599
MANGUERA DE PASO-	CHARTER 3"	MANGUERA DE AGUA-	30T 3/4"
MANGUERA INFERIOR-	CHARTER 2 1/2"	MANGUERA DE AGUA-	30T 5/8"
MANGUERA SUPERIOR-	CHARTER 2 1/2"	MANGUERA DE PASO-	CHARTER 1 3/4"
1992		MANGUERA SILICÓN-	SIH250363C
MANGUERA INFERIOR-TUBO A RAD.	21472	1997	
MANGUERA DE CALEFACCIÓN-	35B 5/8"	BANDA-VENT-OPCIONAL	3/9500PB
MANGUERA DE CALEFACCIÓN-	CHARTER 3/4"	BANDA-VENT- OPCIONAL	9500



MASTER SERVICIO PESADO 2014

FREIGHTLINER

FLC

BANDA-VENT	9510	MANGUERA INFERIOR-TUBO A RAD.	21472
MANGUERA INFERIOR-TUBO A RAD.	21472	MANGUERA SILICÓN-ENTRADA A BA	SIH300363C
MANGUERA SILICÓN-ENTRADA A BA	SIH300363C	MANGUERA DE AGUA-	30T 3/4"
BANDA-ALT	2/9510PB	MANGUERA DE AGUA-	30T 5/8"
TERMOSTATO-190°	33599	MANGUERA DE PASO-	CHARTER 1 3/4"
MANGUERA DE AGUA-	30T 3/4"	MANGUERA SILICÓN-	SIH250363C
MANGUERA DE AGUA-	30T 5/8"	DETROIT DIESEL 6 CIL, 11.1 L DIESEL	
MANGUERA DE PASO-	CHARTER 1 3/4"	2000	
MANGUERA SILICÓN-	SIH250363C	TERMOSTATO-190°	33599
1996		1999	
BANDA-VENT- OPCIONAL	9500	TERMOSTATO-190°	33599
BANDA-VENT	3/9500PB	1998	
BANDA-VENT	9510	BANDA-VENT- OPCIONAL	9500
MANGUERA INFERIOR-TUBO A RAD.	21472	BANDA-VENT	3/9500PB
MANGUERA SILICÓN-ENTRADA A BA	SIH300363C	BANDA-VENT	9510
BANDA-ALT	2/9510PB	MANGUERA INFERIOR-TUBO A RAD.	21472
TERMOSTATO-190°	33599	MANGUERA SILICÓN-ENTRADA A BA	SIH300363C
MANGUERA DE AGUA-	30T 3/4"	BANDA-ALT	2/9510PB
MANGUERA DE AGUA-	30T 5/8"	TERMOSTATO-190°	33599
MANGUERA DE PASO-	CHARTER 1 3/4"	MANGUERA DE AGUA-	30T 3/4"
MANGUERA SILICÓN-	SIH250363C	MANGUERA DE AGUA-	30T 5/8"
1994		MANGUERA DE PASO-	CHARTER 1 3/4"
MANGUERA INFERIOR-TUBO A RAD.	21472	MANGUERA SILICÓN-	SIH250363C
MANGUERA SILICÓN-ENTRADA A BA	SIH300363C	1997	
MANGUERA DE AGUA-	30T 3/4"	BANDA-VENT-OPCIONAL	3/9500PB
MANGUERA DE AGUA-	30T 5/8"	BANDA-VENT- OPCIONAL	9500
MANGUERA DE PASO-	CHARTER 1 3/4"	BANDA-VENT	9510
MANGUERA SILICÓN-	SIH250363C	MANGUERA INFERIOR-TUBO A RAD.	21472
1993		MANGUERA SILICÓN-ENTRADA A BA	SIH300363C
MANGUERA INFERIOR-TUBO A RAD.	21472	BANDA-ALT	2/9510PB
MANGUERA SILICÓN-ENTRADA A BA	SIH300363C	TERMOSTATO-190°	33599
MANGUERA DE AGUA-	30T 3/4"	MANGUERA DE AGUA-	30T 3/4"
MANGUERA DE AGUA-	30T 5/8"	MANGUERA DE AGUA-	30T 5/8"
MANGUERA DE PASO-	CHARTER 1 3/4"	MANGUERA DE PASO-	CHARTER 1 3/4"
MANGUERA SILICÓN-	SIH250363C	MANGUERA SILICÓN-	SIH250363C
1992		1996	
MANGUERA INFERIOR-TUBO A RAD.	21472	TERMOSTATO-190°	33599
MANGUERA SILICÓN-ENTRADA A BA	SIH300363C	1995	
MANGUERA DE AGUA-	30T 3/4"	MANGUERA INFERIOR-TUBO A RAD.	21472
MANGUERA DE AGUA-	30T 5/8"	MANGUERA SILICÓN-TUBO A RAD.	SIH250363C
MANGUERA DE PASO-	CHARTER 1 3/4"	MANGUERA SILICÓN-ENTRADA A BA	SIH300363C
MANGUERA SILICÓN-	SIH250363C	TERMOSTATO-190°	33599
1991		MANGUERA DE AGUA-	30T 3/4"



MASTER SERVICIO PESADO 2014

FREIGHTLINER

FLC

MANGUERA DE AGUA-	30T 5/8"	MANGUERA SILICÓN-CON POSTENFRIADOR	SIH300363C
MANGUERA DE PASO-	CHARTER 1 3/4"	BANDA-BA	K060425
MANGUERA SILICÓN-	SIH250363C	BANDA-ALT	2/9451PB
1994		BANDA-ALT	9451
MANGUERA INFERIOR-TUBO A RAD.	21472	TERMOSTATO-190°	33579
MANGUERA SILICÓN-ENTRADA A BA	SIH300363C	TERMOSTATO-180°	33576
TERMOSTATO-190°	33599	TERMOSTATO-180°	33578
MANGUERA DE AGUA-	30T 3/4"	TERMOSTATO-170°	33577
MANGUERA DE AGUA-	30T 5/8"	BANDA-	2/9435PB
MANGUERA DE PASO-	CHARTER 1 3/4"	BANDA-	9435
MANGUERA SILICÓN-	SIH250363C	MANGUERA DE AGUA-	30T 3/4"
1993		MANGUERA DE PASO-	CHARTER 1 1/2"
MANGUERA INFERIOR-TUBO A RAD.	21472	MANGUERA SUPERIOR FLEXIBLE-	2T170
MANGUERA SILICÓN-ENTRADA A BA	SIH300363C	1997	
TERMOSTATO-190°	33599	BANDA-VENT- OPCIONAL	TR28412
MANGUERA DE AGUA-	30T 3/4"	BANDA-VENT	2/TR28411PB
MANGUERA DE AGUA-	30T 5/8"	BANDA-VENT	PQ28412
MANGUERA DE PASO-	CHARTER 1 3/4"	MANGUERA SILICÓN-SIN POSTENFRIADOR	SIH200363C
MANGUERA SILICÓN-	SIH250363C	MANGUERA SILICÓN-SIN POSTENFRIADOR	SIH250363C
1992		MANGUERA DE ENFRIAMIENTO-POSTENFRIADOR	21488
MANGUERA INFERIOR-TUBO A RAD.	21472	MANGUERA DE PASO-POSTENFRIADOR	21488
MANGUERA SILICÓN-ENTRADA A BA	SIH300363C	MANGUERA SILICÓN-CON POSTENFRIADOR	SIH250363C
TERMOSTATO-190°	33599	MANGUERA SILICÓN-CON POSTENFRIADOR	SIH300363C
MANGUERA DE AGUA-	30T 3/4"	BANDA-BA	K060425
MANGUERA DE AGUA-	30T 5/8"	BANDA-ALT	2/9451PB
MANGUERA DE PASO-	CHARTER 1 3/4"	BANDA-ALT	9451
MANGUERA SILICÓN-	SIH250363C	BANDA-ALT	PQ17450
1991		BANDA-AA	2/9435PB
MANGUERA INFERIOR-TUBO A RAD.	21472	BANDA-AA	PQ17440
MANGUERA SILICÓN-ENTRADA A BA	SIH300363C	TERMOSTATO-190°	33579
TERMOSTATO-190°	33599	TERMOSTATO-180°	33576
MANGUERA DE AGUA-	30T 3/4"	TERMOSTATO-180°	33578
MANGUERA DE AGUA-	30T 5/8"	TERMOSTATO-170°	33577
MANGUERA DE PASO-	CHARTER 1 3/4"	BANDA-	2/9435PB
MANGUERA SILICÓN-	SIH250363C	BANDA-	9435
CUMMINS N14 DIESEL		MANGUERA DE AGUA-	30T 3/4"
1998		MANGUERA DE CALEFACCIÓN-	CHARTER 3/4"
BANDA-VENT- OPCIONAL	TR28412	MANGUERA DE PASO-	CHARTER 1 1/2"
BANDA-VENT	2/TR28411PB	MANGUERA INFERIOR-	CHARTER 1 1/4"
MANGUERA SILICÓN-SIN POSTENFRIADOR	SIH200363C	MANGUERA INFERIOR-	CHARTER 2 1/2"
MANGUERA SILICÓN-SIN POSTENFRIADOR	SIH250363C	MANGUERA INFERIOR-	CHARTER 3"
MANGUERA DE ENFRIAMIENTO-POSTENFRIADOR	21488	MANGUERA SUPERIOR-	CHARTER 2 1/2"
MANGUERA SILICÓN-CON POSTENFRIADOR	SIH250363C		



MASTER SERVICIO PESADO 2014

FREIGHTLINER

FLC

MANGUERA SUPERIOR-	CHARTER 2"	BANDA-AA	PQ17420
MANGUERA SUPERIOR FLEXIBLE-	25T140	BANDA-AA	PQ17430
MANGUERA SUPERIOR FLEXIBLE-	2T170	BANDA-AA	PQ17440
1996		BANDA-AA	PQ17450
BANDA-VENT- OPCIONAL	TR28429	BANDA-AA	PQ17540
BANDA-VENT- OPCIONAL	TR28437	TERMOSTATO-190°	33579
BANDA-VENT- OPCIONAL	TR28473	TERMOSTATO-180°	33576
BANDA-VENT- OPCIONAL	TR28480	TERMOSTATO-180°	33578
BANDA-VENT- OPCIONAL	TR28492	TERMOSTATO-170°	33577
BANDA-VENT	2/TR28429PB	BANDA-	9405
BANDA-VENT	2/TR28437PB	BANDA-	9412
BANDA-VENT	2/TR28473PB	BANDA-	9420
BANDA-VENT	2/TR28480PB	BANDA-	9425
BANDA-VENT	2/TR28492PB	BANDA-	9430
BANDA-VENT	PQ28429	BANDA-	9435
BANDA-VENT	PQ28437	BANDA-	9447
BANDA-VENT	PQ28445	BANDA-	9451
BANDA-VENT	PQ28473	BANDA-	9540
BANDA-VENT	PQ28480	MANGUERA DE AGUA-	30T 3/4"
BANDA-VENT	PQ28492	MANGUERA DE CALEFACCIÓN-	CHARTER 3/4"
BANDA-VENT	TR28445	MANGUERA DE PASO-	CHARTER 1 1/2"
MANGUERA SILICÓN-SIN POSTENFRIADOR	SIH200363C	MANGUERA INFERIOR-	CHARTER 1 1/4"
MANGUERA SILICÓN-SIN POSTENFRIADOR	SIH250363C	MANGUERA INFERIOR-	CHARTER 2 1/2"
MANGUERA DE ENFRIAMIENTO-POSTENFRIADOR	21488	MANGUERA INFERIOR-	CHARTER 3"
MANGUERA DE PASO-POSTENFRIADOR	21488	MANGUERA SUPERIOR-	26510
MANGUERA SILICÓN-CON POSTENFRIADOR	SIH250363C	MANGUERA SUPERIOR-	CHARTER 2 1/2"
MANGUERA SILICÓN-CON POSTENFRIADOR	SIH300363C	MANGUERA SUPERIOR-	CHARTER 2"
BANDA-BA	K040430	MANGUERA SUPERIOR FLEXIBLE-	2T170
BANDA-BA	K040445	1995	
BANDA-ALT-C/ALT 90A	2/9451PB	BANDA-VENT- OPCIONAL	TR28429
BANDA-ALT-C/ALT 90A	9451	BANDA-VENT- OPCIONAL	TR28437
BANDA-ALT 90A	2/9451PB	BANDA-VENT- OPCIONAL	TR28473
BANDA-ALT 90A	PQ17450	BANDA-VENT- OPCIONAL	TR28480
BANDA-ALT	2/9463PB	BANDA-VENT- OPCIONAL	TR28492
BANDA-ALT	2/TR28501PB	BANDA-VENT	2/TR28429PB
BANDA-ALT	9463	BANDA-VENT	2/TR28437PB
BANDA-ALT	PQ17460	BANDA-VENT	2/TR28473PB
BANDA-ALT	PQ28501	BANDA-VENT	2/TR28480PB
BANDA-ALT	TR28501	BANDA-VENT	2/TR28492PB
BANDA-AA	8405 GS	BANDA-VENT	PQ28429
BANDA-AA	8416 GS	BANDA-VENT	PQ28437
BANDA-AA	8430 GS	BANDA-VENT	PQ28445



MASTER SERVICIO PESADO 2014

FREIGHTLINER

FLC

BANDA-VENT	PQ28473	MANGUERA DE AGUA-	30T 3/4"
BANDA-VENT	PQ28480	MANGUERA DE CALEFACCIÓN-	CHARTER 3/4"
BANDA-VENT	PQ28492	MANGUERA DE PASO-	CHARTER 1 1/2"
BANDA-VENT	TR28445	MANGUERA INFERIOR-	CHARTER 1 1/4"
MANGUERA SILICÓN-SIN POSTENFRIADOR	SIH200363C	MANGUERA INFERIOR-	CHARTER 2 1/2"
MANGUERA SILICÓN-SIN POSTENFRIADOR	SIH250363C	MANGUERA INFERIOR-	CHARTER 3"
MANGUERA DE ENFRIAMIENTO-POSTENFRIADOR	21488	MANGUERA SUPERIOR-	26510
MANGUERA DE PASO-POSTENFRIADOR	21488	MANGUERA SUPERIOR-	CHARTER 2 1/2"
MANGUERA SILICÓN-CON POSTENFRIADOR	SIH250363C	MANGUERA SUPERIOR-	CHARTER 2"
MANGUERA SILICÓN-CON POSTENFRIADOR	SIH300363C	MANGUERA SUPERIOR FLEXIBLE-	2T170
BANDA-BA	K040430	1994	
BANDA-BA	K040445	BANDA-VENT- OPCIONAL	TR28429
BANDA-ALT-C/ALT 90A	2/9451PB	BANDA-VENT- OPCIONAL	TR28437
BANDA-ALT-C/ALT 90A	9451	BANDA-VENT- OPCIONAL	TR28473
BANDA-ALT 90A	2/9451PB	BANDA-VENT- OPCIONAL	TR28480
BANDA-ALT 90A	PQ17450	BANDA-VENT- OPCIONAL	TR28492
BANDA-ALT	2/9463PB	BANDA-VENT	2/TR28429PB
BANDA-ALT	2/TR28501PB	BANDA-VENT	2/TR28437PB
BANDA-ALT	9463	BANDA-VENT	2/TR28473PB
BANDA-ALT	PQ17460	BANDA-VENT	2/TR28480PB
BANDA-ALT	PQ28501	BANDA-VENT	2/TR28492PB
BANDA-ALT	TR28501	BANDA-VENT	PQ28429
BANDA-AA	8405 GS	BANDA-VENT	PQ28437
BANDA-AA	8416 GS	BANDA-VENT	PQ28445
BANDA-AA	PQ17420	BANDA-VENT	PQ28473
BANDA-AA	PQ17430	BANDA-VENT	PQ28480
BANDA-AA	PQ17440	BANDA-VENT	PQ28492
BANDA-AA	PQ17450	BANDA-VENT	TR28445
BANDA-AA	PQ17540	MANGUERA SILICÓN-SIN POSTENFRIADOR	SIH200363C
TERMOSTATO-190°	33579	MANGUERA SILICÓN-SIN POSTENFRIADOR	SIH250363C
TERMOSTATO-180°	33576	MANGUERA DE ENFRIAMIENTO-POSTENFRIADOR	21488
TERMOSTATO-180°	33578	MANGUERA DE PASO-POSTENFRIADOR	21488
TERMOSTATO-170°	33577	MANGUERA SILICÓN-CON POSTENFRIADOR	SIH250363C
BANDA-	9405	MANGUERA SILICÓN-CON POSTENFRIADOR	SIH300363C
BANDA-	9412	BANDA-BA	K040430
BANDA-	9420	BANDA-BA	K040445
BANDA-	9425	BANDA-BA	K060425
BANDA-	9430	BANDA-ALT-C/ALT 90A	2/9451PB
BANDA-	9435	BANDA-ALT-C/ALT 90A	9451
BANDA-	9447	BANDA-ALT 90A	2/9451PB
BANDA-	9451	BANDA-ALT 90A	PQ17450
BANDA-	9540	BANDA-ALT	2/9463PB



MASTER SERVICIO PESADO 2014

FREIGHTLINER

FLC

BANDA-ALT	2/TR28501PB	BANDA-VENT	2/TR28437PB
BANDA-ALT	9463	BANDA-VENT	2/TR28473PB
BANDA-ALT	PQ17460	BANDA-VENT	2/TR28480PB
BANDA-ALT	PQ28501	BANDA-VENT	2/TR28492PB
BANDA-ALT	TR28501	BANDA-VENT	PQ28429
BANDA-AA	8405 GS	BANDA-VENT	PQ28437
BANDA-AA	8416 GS	BANDA-VENT	PQ28445
BANDA-AA	PQ17420	BANDA-VENT	PQ28473
BANDA-AA	PQ17430	BANDA-VENT	PQ28480
BANDA-AA	PQ17440	BANDA-VENT	PQ28492
BANDA-AA	PQ17450	BANDA-VENT	TR28445
BANDA-AA	PQ17540	MANGUERA SILICÓN-SIN POSTENFRIADOR	SIH200363C
TERMOSTATO-190°	33579	MANGUERA SILICÓN-SIN POSTENFRIADOR	SIH250363C
TERMOSTATO-180°	33576	MANGUERA DE ENFRIAMIENTO-POSTENFRIADOR	21488
TERMOSTATO-180°	33578	MANGUERA DE PASO-POSTENFRIADOR	21488
TERMOSTATO-170°	33577	MANGUERA SILICÓN-CON POSTENFRIADOR	SIH250363C
BANDA-	9405	MANGUERA SILICÓN-CON POSTENFRIADOR	SIH300363C
BANDA-	9412	BANDA-BA	K040430
BANDA-	9420	BANDA-BA	K040445
BANDA-	9425	BANDA-BA	K060425
BANDA-	9430	BANDA-BA	K060435
BANDA-	9435	BANDA-ALT-C/ALT 90A	2/9451PB
BANDA-	9447	BANDA-ALT-C/ALT 90A	9451
BANDA-	9451	BANDA-ALT 90A	2/9451PB
BANDA-	9540	BANDA-ALT 90A	PQ17450
MANGUERA DE AGUA-	30T 3/4"	BANDA-ALT	2/9463PB
MANGUERA DE CALEFACCIÓN-	CHARTER 3/4"	BANDA-ALT	2/TR28501PB
MANGUERA DE PASO-	CHARTER 1 1/2"	BANDA-ALT	9463
MANGUERA INFERIOR-	CHARTER 1 1/4"	BANDA-ALT	PQ17460
MANGUERA INFERIOR-	CHARTER 2 1/2"	BANDA-ALT	PQ28501
MANGUERA INFERIOR-	CHARTER 3"	BANDA-ALT	TR28501
MANGUERA SUPERIOR-	26510	BANDA-AA	8405 GS
MANGUERA SUPERIOR-	CHARTER 2 1/2"	BANDA-AA	8416 GS
MANGUERA SUPERIOR-	CHARTER 2"	BANDA-AA	9405
MANGUERA SUPERIOR FLEXIBLE-	2T170	BANDA-AA	9412
1993		BANDA-AA	9420
BANDA-VENT- OPCIONAL	TR28429	BANDA-AA	9425
BANDA-VENT- OPCIONAL	TR28437	BANDA-AA	9430
BANDA-VENT- OPCIONAL	TR28473	BANDA-AA	9435
BANDA-VENT- OPCIONAL	TR28480	BANDA-AA	9447
BANDA-VENT- OPCIONAL	TR28492	BANDA-AA	9451
BANDA-VENT	2/TR28429PB	BANDA-AA	PQ17420



MASTER SERVICIO PESADO 2014

FREIGHTLINER

FLC

BANDA-AA	PQ17430	MANGUERA SILICÓN-CON POSTENFRIADOR	SIH300363C
BANDA-AA	PQ17440	BANDA-BA	K040430
BANDA-AA	PQ17450	BANDA-BA	K040445
BANDA-AA	PQ17540	BANDA-BA	K060435
TERMOSTATO-190°	33579	BANDA-ALT-C/ALT 90A	2/9451PB
TERMOSTATO-180°	33576	BANDA-ALT-C/ALT 90A	9451
TERMOSTATO-180°	33578	BANDA-ALT 90A	2/9451PB
TERMOSTATO-170°	33577	BANDA-ALT 90A	PQ17450
BANDA-	9540	BANDA-ALT	2/9463PB
MANGUERA DE AGUA-	30T 3/4"	BANDA-ALT	2/TR28501PB
MANGUERA DE CALEFACCIÓN-	CHARTER 3/4"	BANDA-ALT	9463
MANGUERA DE PASO-	CHARTER 1 1/2"	BANDA-ALT	PQ17460
MANGUERA INFERIOR-	CHARTER 1 1/4"	BANDA-ALT	PQ28501
MANGUERA INFERIOR-	CHARTER 2 1/2"	BANDA-ALT	TR28501
MANGUERA INFERIOR-	CHARTER 3"	BANDA-AA	8405 GS
MANGUERA SUPERIOR-	26510	BANDA-AA	8416 GS
MANGUERA SUPERIOR-	CHARTER 2 1/2"	BANDA-AA	9405
MANGUERA SUPERIOR-	CHARTER 2"	BANDA-AA	9412
MANGUERA SUPERIOR FLEXIBLE-	2T170	BANDA-AA	9420
1992		BANDA-AA	9425
BANDA-VENT	2/TR28429PB	BANDA-AA	9430
BANDA-VENT	2/TR28437PB	BANDA-AA	9435
BANDA-VENT	2/TR28473PB	BANDA-AA	9447
BANDA-VENT	2/TR28480PB	BANDA-AA	9451
BANDA-VENT	2/TR28492PB	BANDA-AA	9540
BANDA-VENT	PQ28429	BANDA-AA	PQ17420
BANDA-VENT	PQ28437	BANDA-AA	PQ17430
BANDA-VENT	PQ28445	BANDA-AA	PQ17440
BANDA-VENT	PQ28473	BANDA-AA	PQ17450
BANDA-VENT	PQ28480	BANDA-AA	PQ17540
BANDA-VENT	PQ28492	TERMOSTATO-190°	33579
BANDA-VENT	TR28429	TERMOSTATO-180°	33576
BANDA-VENT	TR28437	TERMOSTATO-180°	33578
BANDA-VENT	TR28445	TERMOSTATO-170°	33577
BANDA-VENT	TR28473	MANGUERA DE AGUA-	30T 3/4"
BANDA-VENT	TR28480	MANGUERA DE CALEFACCIÓN-	CHARTER 3/4"
BANDA-VENT	TR28492	MANGUERA DE PASO-	CHARTER 1 1/2"
MANGUERA SILICÓN-SIN POSTENFRIADOR	SIH200363C	MANGUERA INFERIOR-	CHARTER 1 1/4"
MANGUERA SILICÓN-SIN POSTENFRIADOR	SIH250363C	MANGUERA INFERIOR-	CHARTER 2 1/2"
MANGUERA DE ENFRIAMIENTO-POSTENFRIADOR	21488	MANGUERA INFERIOR-	CHARTER 3"
MANGUERA DE PASO-POSTENFRIADOR	21488	MANGUERA SUPERIOR-	26510
MANGUERA SILICÓN-CON POSTENFRIADOR	SIH250363C	MANGUERA SUPERIOR-	CHARTER 2 1/2"



MASTER SERVICIO PESADO 2014

FREIGHTLINER

FLC

MANGUERA SUPERIOR-	CHARTER 2"	MANGUERA DE AGUA-	30T 3/4"
MANGUERA SUPERIOR FLEXIBLE-	2T170	MANGUERA DE PASO-	CHARTER 1 1/2"
1991		MANGUERA POSTENFRIADOR-	21488
BANDA-VENT	2/TR28429PB	MANGUERA SUPERIOR FLEXIBLE-	2T170
BANDA-VENT	2/TR28437PB	CUMMINS M11 DIESEL	
BANDA-VENT	2/TR28473PB	1998	
BANDA-VENT	2/TR28480PB	TERMOSTATO-190°	33579
BANDA-VENT	2/TR28492PB	TERMOSTATO-180°	33576
BANDA-VENT	TR28429	TERMOSTATO-180°	33578
BANDA-VENT	TR28437	TERMOSTATO-170°	33577
BANDA-VENT	TR28445	1997	
BANDA-VENT	TR28473	BANDA-VENT	K080496
BANDA-VENT	TR28480	MANGUERA SILICÓN-TUBO A RAD.	SIH250363C
BANDA-VENT	TR28492	MANGUERA SUPERIOR-TUBO A RAD.	CHARTER 2 1/2"
MANGUERA SILICÓN-SIN POSTENFRIADOR	SIH200363C	MANGUERA SUPERIOR-MOTOR A TUBO	24436
MANGUERA SILICÓN-SIN POSTENFRIADOR	SIH250363C	MANGUERA SUPERIOR-MOTOR A TUBO	CHARTER 2 1/4"
MANGUERA SILICÓN-CON POSTENFRIADOR	SIH250363C	BANDA-ALT	K050345
MANGUERA SILICÓN-CON POSTENFRIADOR	SIH300363C	BANDA-AA	PQ17550
BANDA-BA	K040430	TERMOSTATO-190°	33579
BANDA-BA	K040445	TERMOSTATO-180°	33576
BANDA-BA	K060435	TERMOSTATO-180°	33578
BANDA-ALT-C/ALT 90A	2/9451PB	TERMOSTATO-170°	33577
BANDA-ALT-C/ALT 90A	9451	BANDA-	9545
BANDA-ALT	2/9463PB	MANGUERA DE PASO-	CHARTER 1 3/4"
BANDA-ALT	2/TR28501PB	MANGUERA INFERIOR-	CHARTER 2 1/2"
BANDA-ALT	9463	MANGUERA SILICÓN-	SIH250363C
BANDA-ALT	TR28501	1996	
BANDA-AA	9405	BANDA-VENT	K080496
BANDA-AA	9412	MANGUERA SILICÓN-TUBO A RAD.	SIH250363C
BANDA-AA	9420	MANGUERA SUPERIOR-TUBO A RAD.	CHARTER 2 1/2"
BANDA-AA	9425	MANGUERA SUPERIOR-MOTOR A TUBO	24436
BANDA-AA	9430	MANGUERA SUPERIOR-MOTOR A TUBO	CHARTER 2 1/4"
BANDA-AA	9435	BANDA-ALT	K050345
BANDA-AA	9447	BANDA-AA	PQ17550
BANDA-AA	9451	TERMOSTATO-190°	33579
BANDA-AA	9540	TERMOSTATO-180°	33576
TERMOSTATO-190°	33579	TERMOSTATO-180°	33578
TERMOSTATO-180°	33576	TERMOSTATO-170°	33577
TERMOSTATO-180°	33578	BANDA-	9545
TERMOSTATO-180°	33961	MANGUERA DE PASO-	CHARTER 1 3/4"
TERMOSTATO-180°	33962	MANGUERA INFERIOR-	CHARTER 2 1/2"
TERMOSTATO-170°	33577	MANGUERA SILICÓN-	SIH250363C
		1995	



MASTER SERVICIO PESADO 2014

FREIGHTLINER

FLC

BANDA-VENT	K080496	TERMOSTATO-175°	33960
MANGUERA SILICÓN-TUBO A RAD.	SIH250363C	TERMOSTATO-170°	33577
MANGUERA SUPERIOR-TUBO A RAD.	CHARTER 2 1/2"	1993	
MANGUERA SUPERIOR-MOTOR A TUBO	24436	MANGUERA INFERIOR-VIBRAFLEX GS	23572
MANGUERA SUPERIOR-MOTOR A TUBO	CHARTER 2 1/4"	BANDA-VENT	K080485
BANDA-ALT	K050345	BANDA-VENT	K080570
BANDA-AA	PQ17550	BANDA-VENT	K080585
TERMOSTATO-190°	33579	BANDA-VENT	K080690
TERMOSTATO-180°	33576	MANGUERA SILICÓN-TUBO A TUBO	SIH250363C
TERMOSTATO-180°	33578	MANGUERA INFERIOR-TUBO A RAD.	23572
TERMOSTATO-170°	33577	MANGUERA SILICÓN-TUBO A RAD.	SIH250363C
BANDA-	9545	MANGUERA SUPERIOR-TUBO A RAD.	CHARTER 2 1/2"
MANGUERA DE PASO-	CHARTER 1 3/4"	MANGUERA SUPERIOR-TUBO A RAD.	CHARTER 2 1/4"
MANGUERA INFERIOR-	CHARTER 2 1/2"	MANGUERA SILICÓN-MOTOR A TUBO	SIH250363C
MANGUERA SILICÓN-	SIH250363C	MANGUERA SUPERIOR-MOTOR A TUBO	24436
1994		BANDA-ALT S/TURBO	K050340
TERMOSTATO-190°	33579	BANDA-ALT C/TURBO	K050350
TERMOSTATO-180°	33576	BANDA-ALT	K050350
TERMOSTATO-180°	33578	BANDA-AA S/TURBO	8573 GS
TERMOSTATO-170°	33577	BANDA-AA S/TURBO	PQ17530
CUMMINS L10 DIESEL		BANDA-AA C/TURBO	PQ17530
1997		BANDA-AA C/TURBO	PQ17550
TERMOSTATO-190°	33579	BANDA-AA C/TURBO	TR22508
TERMOSTATO-180°	33576	BANDA-AA	9510
TERMOSTATO-180°	33578	BANDA-AA	PQ17510
TERMOSTATO-175°	33960	TERMOSTATO-190°	33579
TERMOSTATO-170°	33577	TERMOSTATO-180°	33576
1996		TERMOSTATO-180°	33578
TERMOSTATO-190°	33579	TERMOSTATO-175°	33960
TERMOSTATO-180°	33576	TERMOSTATO-170°	33577
TERMOSTATO-180°	33578	BANDA-	9530
TERMOSTATO-175°	33960	BANDA-	9545
TERMOSTATO-170°	33577	MANGUERA DE AGUA-	30T 3/4"
1995		MANGUERA DE CALEFACCIÓN-	CHARTER 3/4"
TERMOSTATO-190°	33579	MANGUERA DE PASO-	CHARTER 1 1/2"
TERMOSTATO-180°	33576	MANGUERA INFERIOR-	CHARTER 2 1/2"
TERMOSTATO-180°	33578	1992	
TERMOSTATO-175°	33960	MANGUERA INFERIOR-VIBRAFLEX GS	23572
TERMOSTATO-170°	33577	BANDA-VENT	K080485
1994		BANDA-VENT	K080570
TERMOSTATO-190°	33579	BANDA-VENT	K080585
TERMOSTATO-180°	33576	BANDA-VENT	K080690
TERMOSTATO-180°	33578		



MASTER SERVICIO PESADO 2014

FREIGHTLINER

FLC

MANGUERA SILICÓN-TUBO A TUBO	SIH250363C	BANDA-ALT C/TURBO	K050350
MANGUERA INFERIOR-TUBO A RAD.	23572	BANDA-ALT	K050350
MANGUERA SILICÓN-TUBO A RAD.	SIH250363C	BANDA-AA S/TURBO	8573 GS
MANGUERA SUPERIOR-TUBO A RAD.	CHARTER 2 1/2"	BANDA-AA S/TURBO	PQ17530
MANGUERA SUPERIOR-TUBO A RAD.	CHARTER 2 1/4"	BANDA-AA C/TURBO	PQ17530
MANGUERA SILICÓN-MOTOR A TUBO	SIH250363C	BANDA-AA C/TURBO	PQ17550
MANGUERA SUPERIOR-MOTOR A TUBO	24436	BANDA-AA C/TURBO	TR22508
BANDA-ALT S/TURBO	K050340	BANDA-AA	9510
BANDA-ALT C/TURBO	K050350	BANDA-AA	9530
BANDA-ALT	K050350	BANDA-AA	9545
BANDA-AA S/TURBO	8573 GS	BANDA-AA	PQ17510
BANDA-AA S/TURBO	PQ17530	TERMOSTATO-190°	33579
BANDA-AA C/TURBO	PQ17530	TERMOSTATO-180°	33576
BANDA-AA C/TURBO	PQ17550	TERMOSTATO-180°	33578
BANDA-AA C/TURBO	TR22508	TERMOSTATO-175°	33960
BANDA-AA	9510	TERMOSTATO-170°	33577
BANDA-AA	9530	MANGUERA DE AGUA-	30T 3/4"
BANDA-AA	9545	MANGUERA DE CALEFACCIÓN-	CHARTER 3/4"
BANDA-AA	PQ17510	MANGUERA DE PASO-	CHARTER 1 1/2"
TERMOSTATO-190°	33579	MANGUERA INFERIOR-	CHARTER 2 1/2"
TERMOSTATO-180°	33576	1990	
TERMOSTATO-180°	33578	MANGUERA INFERIOR-VIBRAFLEX GS	23572
TERMOSTATO-175°	33960	BANDA-VENT	K080485
TERMOSTATO-170°	33577	BANDA-VENT	K080570
MANGUERA DE AGUA-	30T 3/4"	BANDA-VENT	K080585
MANGUERA DE CALEFACCIÓN-	CHARTER 3/4"	BANDA-VENT	K080690
MANGUERA DE PASO-	CHARTER 1 1/2"	MANGUERA SUPERIOR-TUBO A RAD.	CHARTER 2 1/2"
MANGUERA INFERIOR-	CHARTER 2 1/2"	MANGUERA SUPERIOR-TUBO A RAD.	CHARTER 2 1/4"
1991		BANDA-ALT S/TURBO	K050340
MANGUERA INFERIOR-VIBRAFLEX GS	23572	BANDA-ALT C/TURBO	K050350
BANDA-VENT	K080485	BANDA-AA S/TURBO	8573 GS
BANDA-VENT	K080570	BANDA-AA S/TURBO	PQ17530
BANDA-VENT	K080585	BANDA-AA C/TURBO	PQ17530
BANDA-VENT	K080690	BANDA-AA C/TURBO	PQ17550
MANGUERA SILICÓN-TUBO A TUBO	SIH250363C	BANDA-AA C/TURBO	TR22508
MANGUERA INFERIOR-TUBO A RAD.	23572	BANDA-AA	PQ17510
MANGUERA SILICÓN-TUBO A RAD.	SIH250363C	TERMOSTATO-175°	33960
MANGUERA SUPERIOR-TUBO A RAD.	CHARTER 2 1/2"	MANGUERA DE CALEFACCIÓN-	CHARTER 3/4"
MANGUERA SUPERIOR-TUBO A RAD.	CHARTER 2 1/4"	MANGUERA DE PASO-	CHARTER 1 1/2"
MANGUERA SILICÓN-MOTOR A TUBO	SIH250363C	MANGUERA INFERIOR-	CHARTER 2 1/2"
MANGUERA SUPERIOR-MOTOR A TUBO	24436	CUMMINS C Series 8.3 L DIESEL	
BANDA-ALT S/TURBO	K050340	1996	
		TERMOSTATO-180°-C/DOBLE TERMOSTATO	33966



TERMOSTATO-180°	33959	TERMOSTATO-180°	33578
1995		TERMOSTATO-170°	33577
TERMOSTATO-180°-C/DOBLE TERMOSTATO	33966	1994	
TERMOSTATO-180°	33959	TERMOSTATO-190°	33579
1993		TERMOSTATO-180°	33576
TERMOSTATO-180°-C/DOBLE TERMOSTATO	33966	TERMOSTATO-180°	33578
TERMOSTATO-180°	33959	TERMOSTATO-170°	33577
1992		1993	
TERMOSTATO-180°-C/DOBLE TERMOSTATO	33966	BANDA-VENT	TR20619
TERMOSTATO-180°	33959	BANDA-VENT	TR22588
1991		BANDA-VENT	TR22625
TERMOSTATO-180°-C/DOBLE TERMOSTATO	33966	BANDA-VENT	TR22648
TERMOSTATO-180°	33959	BANDA-ALT-AA	2/9510PB
CATERPILLAR C12 DIESEL		BANDA-ALT-AA	2/9550PB
1997		BANDA-ALT-AA	2/9570PB
TERMOSTATO-190°	33579	BANDA-ALT-AA	9510
TERMOSTATO-180°	33576	BANDA-ALT-AA	9550
TERMOSTATO-180°	33578	BANDA-ALT-AA	9570
TERMOSTATO-170°	33577	TERMOSTATO-190°	33579
CATERPILLAR C10 DIESEL		TERMOSTATO-180°	33576
1997		TERMOSTATO-180°	33578
TERMOSTATO-190°	33579	TERMOSTATO-170°	33577
TERMOSTATO-180°	33576	MANGUERA SILICÓN-	SIH250363C
TERMOSTATO-180°	33578	MANGUERA SUPERIOR-	23562
TERMOSTATO-170°	33577	1992	
CATERPILLAR 3406 DIESEL		BANDA-VENT	TR20619
1998		BANDA-VENT	TR22588
TERMOSTATO-190°	33579	BANDA-VENT	TR22625
TERMOSTATO-180°	33576	BANDA-VENT	TR22648
TERMOSTATO-180°	33578	BANDA-ALT-AA	2/9510PB
TERMOSTATO-170°	33577	BANDA-ALT-AA	2/9550PB
1997		BANDA-ALT-AA	2/9570PB
TERMOSTATO-190°	33579	BANDA-ALT-AA	9510
TERMOSTATO-180°	33576	BANDA-ALT-AA	9550
TERMOSTATO-180°	33578	BANDA-ALT-AA	9570
TERMOSTATO-170°	33577	TERMOSTATO-190°	33579
1996		TERMOSTATO-180°	33576
TERMOSTATO-190°	33579	TERMOSTATO-180°	33578
TERMOSTATO-180°	33576	TERMOSTATO-170°	33577
TERMOSTATO-180°	33578	MANGUERA SILICÓN-	SIH250363C
TERMOSTATO-170°	33577	MANGUERA SUPERIOR-	23562
1995		1991	
TERMOSTATO-190°	33579	BANDA-VENT	TR20619
TERMOSTATO-180°	33576		



MASTER SERVICIO PESADO 2014

FREIGHTLINER

FLC

BANDA-VENT	TR22588	MANGUERA INFERIOR-MOTOR A TUBO	23562
BANDA-VENT	TR22625	MANGUERA SUPERIOR-MOTOR A TUBO	21891
BANDA-VENT	TR22648	MANGUERA SUPERIOR-MOTOR A TUBO	23562
BANDA-ALT-AA	2/9510PB	TERMOSTATO-175°	33549
BANDA-ALT-AA	2/9550PB	MANGUERA DE AGUA-	30T 3/4"
BANDA-ALT-AA	2/9570PB	MANGUERA DE AGUA-	30T 5/8"
BANDA-ALT-AA	9510	1991	
BANDA-ALT-AA	9550	MANGUERA INFERIOR-TUBO A RAD.	21472
BANDA-ALT-AA	9570	MANGUERA SUPERIOR-TUBO A RAD.	23562
TERMOSTATO-190°	33579	MANGUERA INFERIOR-MOTOR-TUBO	23562
TERMOSTATO-180°	33576	MANGUERA SUPERIOR-MOTOR A TUBO	21891
TERMOSTATO-180°	33578	MANGUERA SUPERIOR-MOTOR A TUBO	23562
TERMOSTATO-170°	33577	TERMOSTATO-175°	33549
MANGUERA SILICÓN-	SIH250363C	MANGUERA DE AGUA-	30T 3/4"
MANGUERA SUPERIOR-	23562	MANGUERA DE AGUA-	30T 5/8"
1990		CATERPILLAR 3176 DIESEL	
MANGUERA SUPERIOR-VIBRAFLEX GS	23562	1996	
BANDA-VENT	TR20619	BANDA-ALT-VENT	K080680
BANDA-VENT	TR22588	BANDA-ALT-VENT	K080733
BANDA-VENT	TR22625	BANDA-ALT-VENT	K080740
BANDA-VENT	TR22648	BANDA-ALT-VENT	K080751
BANDA-ALT-AA	2/9510PB	TERMOSTATO-190°	33579
BANDA-ALT-AA	2/9550PB	TERMOSTATO-180°	33576
BANDA-ALT-AA	2/9570PB	TERMOSTATO-180°	33578
BANDA-ALT-AA	9570	TERMOSTATO-170°	33577
BANDA-ALT-AA	PQ17510	BANDA-	9451
BANDA-ALT-AA	PQ17550	BANDA-	9470
TERMOSTATO-175°	33549	BANDA-	9480
MANGUERA INFERIOR-	CHARTER 2 1/2"	BANDA-	9500
		BANDA-	9510
CATERPILLAR 3306 DIESEL		1995	
1997		MANGUERA SILICÓN-TUBO A RAD.	SIH250363C
TERMOSTATO-175°	33549	MANGUERA INFERIOR-MOTOR A TUBO	24436
1994		MANGUERA SILICÓN-MOTOR A TUBO	SIH200363C
TERMOSTATO-175°	33549	BANDA-ALT-VENT	K080680
MANGUERA DE AGUA-	30T 3/4"	BANDA-ALT-VENT	K080733
MANGUERA SILICÓN-	SIH250363C	BANDA-ALT-VENT	K080740
1993		BANDA-ALT-VENT	K080751
TERMOSTATO-175°	33549	TERMOSTATO-190°	33579
MANGUERA DE AGUA-	30T 3/4"	TERMOSTATO-180°	33576
MANGUERA SILICÓN-	SIH250363C	TERMOSTATO-180°	33578
1992		TERMOSTATO-170°	33577
MANGUERA INFERIOR-TUBO A RAD.	21472	BANDA-	9451
MANGUERA SUPERIOR-TUBO A RAD.	23562		



MASTER SERVICIO PESADO 2014

FREIGHTLINER

FLC

BANDA-	9470	MANGUERA DE AGUA-	30T 3/4"
BANDA-	9480	MANGUERA DE AGUA-	30T 5/8"
BANDA-	9500	1992	
BANDA-	9510	MANGUERA SILICÓN-TUBO A RAD.	SIH250363C
MANGUERA DE AGUA-	30T 3/4"	MANGUERA INFERIOR-MOTOR-TUBO	24436
MANGUERA DE AGUA-	30T 5/8"	MANGUERA SILICÓN-MOTOR A TUBO	SIH200363C
1994		BANDA-ALT-VENT	K080680
MANGUERA SILICÓN-TUBO A RAD.	SIH250363C	BANDA-ALT-VENT	K080733
MANGUERA INFERIOR-MOTOR A TUBO	24436	BANDA-ALT-VENT	K080740
MANGUERA SILICÓN-MOTOR A TUBO	SIH200363C	BANDA-ALT-VENT	K080751
BANDA-ALT-VENT	K080680	BANDA-AA	9451
BANDA-ALT-VENT	K080733	BANDA-AA	9470
BANDA-ALT-VENT	K080740	BANDA-AA	9480
BANDA-ALT-VENT	K080751	BANDA-AA	9500
TERMOSTATO-190°	33579	BANDA-AA	9510
TERMOSTATO-180°	33576	TERMOSTATO-190°	33579
TERMOSTATO-180°	33578	TERMOSTATO-180°	33576
TERMOSTATO-170°	33577	TERMOSTATO-180°	33578
BANDA-	9451	TERMOSTATO-170°	33577
BANDA-	9470	MANGUERA DE AGUA-	30T 3/4"
BANDA-	9480	MANGUERA DE AGUA-	30T 5/8"
BANDA-	9500	1991	
BANDA-	9510	MANGUERA SILICÓN-TUBO A RAD.	SIH250363C
MANGUERA DE AGUA-	30T 3/4"	MANGUERA INFERIOR-MOTOR-TUBO	24436
MANGUERA DE AGUA-	30T 5/8"	MANGUERA SILICÓN-MOTOR A TUBO	SIH200363C
1993		BANDA-ALT-VENT	K080680
MANGUERA SILICÓN-TUBO A RAD.	SIH250363C	BANDA-ALT-VENT	K080733
MANGUERA INFERIOR-MOTOR A TUBO	24436	BANDA-ALT-VENT	K080740
MANGUERA SILICÓN-MOTOR A TUBO	SIH200363C	BANDA-ALT-VENT	K080751
BANDA-ALT-VENT	K080680	BANDA-AA	9451
BANDA-ALT-VENT	K080733	BANDA-AA	9470
BANDA-ALT-VENT	K080740	BANDA-AA	9480
BANDA-ALT-VENT	K080751	BANDA-AA	9500
BANDA-AA	9451	BANDA-AA	9510
BANDA-AA	9470	TERMOSTATO-190°	33579
BANDA-AA	9480	TERMOSTATO-180°	33576
BANDA-AA	9500	TERMOSTATO-180°	33578
BANDA-AA	9510	TERMOSTATO-170°	33577
TERMOSTATO-190°	33579	MANGUERA DE AGUA-	30T 3/4"
TERMOSTATO-180°	33576	MANGUERA DE AGUA-	30T 5/8"
TERMOSTATO-180°	33578		
TERMOSTATO-170°	33577		

FLD

MERCEDES BENZ MBE 4000 Diesel



MASTER SERVICIO PESADO 2014

FREIGHTLINER

FLD

2010

BANDA-VENT	K080505	TENSOR-TOMA DE FUERZA-ALT-AA	38501
TENSOR-VENT	38597	MANGUERA SUPERIOR-MOTOR A TUBO	CHARTER 2 1/2"
MANGUERA INFERIOR-TUBO A RAD.	24047	MANGUERA INFERIOR-	CHARTER 2 1/2"
MANGUERA SUPERIOR-TUBO A RAD.	21891	2002	
MANGUERA INFERIOR-MOTOR A TUBO	26045	BANDA-VENT	PQ17520
MANGUERA SUPERIOR-MOTOR A TUBO	24440	MANGUERA SUPERIOR-TUBO A RAD.	CHARTER 2 1/2"
BANDA-AA	K080855	BANDA-TOMA DE FUERZA-ALT-AA (ALT. 135A)	K080575
POLEA DEL TENSOR-AA	38075	BANDA-TOMA DE FUERZA-ALT-AA (ALT. 130A)	K080580
TENSOR-AA	38501	TENSOR-TOMA DE FUERZA-ALT-AA	38501

2009

BANDA-VENT	K080505	MANGUERA SUPERIOR-MOTOR A TUBO	CHARTER 2 1/2"
TENSOR-VENT	38597	MANGUERA INFERIOR-	CHARTER 2 1/2"
MANGUERA INFERIOR-TUBO A RAD.	24047	2001	
MANGUERA SUPERIOR-TUBO A RAD.	21891	BANDA-VENT	PQ17530
MANGUERA INFERIOR-MOTOR A TUBO	26045	MANGUERA SUPERIOR-TUBO A RAD.	CHARTER 2 1/2"
MANGUERA SUPERIOR-MOTOR A TUBO	24440	MANGUERA SUPERIOR-MOTOR A TUBO	CHARTER 2 1/2"
BANDA-AA	K080855	BANDA-ALT-BA-AA (ALT. 135A)	K080575
POLEA DEL TENSOR-AA	38075	BANDA-ALT-BA-AA (ALT. 130A)	K080580
TENSOR-AA	38501	MANGUERA INFERIOR-	CHARTER 3"

DETROIT DIESEL SERIE 60

2006

BANDA-VENT	K100579	MANGUERA SUPERIOR-TUBO A RAD.	CHARTER 2 1/2"
TENSOR-VENT	38503	MANGUERA SUPERIOR-MOTOR A TUBO	CHARTER 2 1/2"
BANDA-TOMA DE FUERZA-ALT-AA	K080565	BANDA-ALT-BA-AA	K080580
TENSOR-TOMA DE FUERZA-ALT-AA	38501	BANDA-ALT-BA-AA	PQ17510
MANGUERA INFERIOR-RAD. A TUBO	21135	MANGUERA INFERIOR-	CHARTER 2 1/2"
MANGUERA SUPERIOR-RAD. A TUBO	21115	MANGUERA INFERIOR-	CHARTER 3"
MANGUERA SUPERIOR-MOTOR A TUBO	CHARTER 2 1/2"	1999	
MANGUERA INFERIOR-	CHARTER 2 1/2"	BANDA-VENT	8616 GS

2004

BANDA-VENT	3/9525PB	MANGUERA SUPERIOR-TUBO A RAD.	CHARTER 2 1/2"
BANDA-VENT	9525	MANGUERA SUPERIOR-MOTOR A TUBO	CHARTER 2 1/2"
MANGUERA SUPERIOR-TUBO A RAD.	CHARTER 2 1/2"	MANGUERA INFERIOR-	CHARTER 2 1/2"
BANDA-TOMA DE FUERZA-ALT-AA	K080570	MANGUERA INFERIOR-	CHARTER 3"
TENSOR-TOMA DE FUERZA-ALT-AA	38501	1998	
MANGUERA SUPERIOR-MOTOR A TUBO	CHARTER 2 1/2"	BANDA-VENT	PQ17510
MANGUERA INFERIOR-	CHARTER 2 1/2"	MANGUERA INFERIOR-TUBO A RAD.	21472

2003

BANDA-VENT	PQ17520	MANGUERA SUPERIOR-TUBO A RAD.	CHARTER 2 1/2"
MANGUERA SUPERIOR-TUBO A RAD.	CHARTER 2 1/2"	MANGUERA SUPERIOR-MOTOR A TUBO	CHARTER 2 1/2"
BANDA-TOMA DE FUERZA-ALT-AA (ALT. 135A)	K080570	MANGUERA DE CALEFACCIÓN-	35B 5/8"
BANDA-TOMA DE FUERZA-ALT-AA (ALT. 130A)	K080580	MANGUERA DE CALEFACCIÓN-	CHARTER 3/4"
		MANGUERA DE PASO-	CHARTER 1 3/4"
		MANGUERA DE PASO-	CHARTER 3"



MASTER SERVICIO PESADO 2014

FREIGHTLINER

FLD

MANGUERA INFERIOR-	CHARTER 2 1/2"	BANDA-VENT	8616 GS
1997		BANDA-VENT	PQ17510
BANDA-VENT	PQ17510	BANDA-VENT	PQ17530
MANGUERA INFERIOR-TUBO A RAD.	21472	MANGUERA INFERIOR-TUBO A RAD.	21472
MANGUERA SUPERIOR-TUBO A RAD.	CHARTER 2 1/2"	BANDA-ALT-VENT-AA	PQ17510
BANDA-TOMA DE FUERZA-ALT-AA	2/9510PB	BANDA-ALT-AA	2/9510PB
MANGUERA SUPERIOR-MOTOR A TUBO	CHARTER 2 1/2"	BANDA-ALT PRESTOLITE	2/9555PB
MANGUERA DE CALEFACCIÓN-	35B 5/8"	BANDA-ALT DELCO	2/9500PB
MANGUERA DE CALEFACCIÓN-	CHARTER 3/4"	BANDA-ALT DELCO	2/9545PB
MANGUERA DE PASO-	CHARTER 1 3/4"	BANDA-ALT	2/9510PB
MANGUERA DE PASO-	CHARTER 3"	BANDA-AA	PQ17530
MANGUERA INFERIOR-	CHARTER 2 1/2"	MANGUERA DE CALEFACCIÓN-	35B 5/8"
MANGUERA INFERIOR-	CHARTER 3 1/2"	MANGUERA DE CALEFACCIÓN-	CHARTER 3/4"
1996		MANGUERA DE PASO-	CHARTER 1 3/4"
BANDA-VENT	PQ17520	MANGUERA DE PASO-	CHARTER 3"
MANGUERA INFERIOR-TUBO A RAD.	21472	MANGUERA INFERIOR-	CHARTER 2 1/2"
BANDA-ALT-AA	2/9545PB	MANGUERA SUPERIOR-	CHARTER 2 1/2"
MANGUERA DE CALEFACCIÓN-	35B 5/8"	1993	
MANGUERA DE CALEFACCIÓN-	CHARTER 3/4"	BANDA-VENT	2/9590PB
MANGUERA DE PASO-	CHARTER 1 3/4"	BANDA-VENT	8616 GS
MANGUERA DE PASO-	CHARTER 3"	BANDA-VENT	PQ17510
MANGUERA INFERIOR-	CHARTER 2 1/2"	BANDA-VENT	PQ17530
MANGUERA SUPERIOR-	CHARTER 2 1/2"	MANGUERA INFERIOR-TUBO A RAD.	21472
1995		BANDA-ALT-AA	2/9510PB
BANDA-VENT	2/9590PB	BANDA-ALT PRESTOLITE	2/9555PB
BANDA-VENT	8616 GS	BANDA-ALT DELCO	2/9500PB
BANDA-VENT	PQ17510	BANDA-ALT DELCO	2/9545PB
BANDA-VENT	PQ17530	BANDA-ALT	2/9510PB
MANGUERA INFERIOR-TUBO A RAD.	21472	BANDA-AA	PQ17530
BANDA-ALT-AA	2/9510PB	MANGUERA DE CALEFACCIÓN-	35B 5/8"
BANDA-ALT PRESTOLITE	2/9555PB	MANGUERA DE CALEFACCIÓN-	CHARTER 3/4"
BANDA-ALT DELCO	2/9500PB	MANGUERA DE PASO-	CHARTER 1 3/4"
BANDA-ALT DELCO	2/9545PB	MANGUERA DE PASO-	CHARTER 3"
BANDA-ALT	2/9510PB	MANGUERA INFERIOR-	CHARTER 2 1/2"
BANDA-AA	PQ17530	MANGUERA SUPERIOR-	CHARTER 2 1/2"
MANGUERA DE CALEFACCIÓN-	35B 5/8"	1992	
MANGUERA DE CALEFACCIÓN-	CHARTER 3/4"	BANDA-VENT	2/9590PB
MANGUERA DE PASO-	CHARTER 1 3/4"	BANDA-VENT	8616 GS
MANGUERA DE PASO-	CHARTER 3"	BANDA-VENT	PQ17510
MANGUERA INFERIOR-	CHARTER 2 1/2"	BANDA-VENT	PQ17530
MANGUERA SUPERIOR-	CHARTER 2 1/2"	MANGUERA INFERIOR-TUBO A RAD.	21472
1994		BANDA-ALT-AA	2/9510PB
BANDA-VENT	2/9590PB		



MASTER SERVICIO PESADO 2014

FREIGHTLINER

FLD

BANDA-ALT PRESTOLITE	2/9555PB	MANGUERA DE CALEFACCIÓN-	35B 5/8"
BANDA-ALT DELCO	2/9500PB	MANGUERA DE CALEFACCIÓN-	CHARTER 3/4"
BANDA-ALT DELCO	2/9545PB	MANGUERA DE PASO-	CHARTER 1 3/4"
BANDA-ALT	2/9510PB	MANGUERA DE PASO-	CHARTER 3"
BANDA-AA	PQ17530	MANGUERA INFERIOR-	CHARTER 2 1/2"
MANGUERA DE CALEFACCIÓN-	35B 5/8"	MANGUERA SUPERIOR-	CHARTER 2 1/2"
MANGUERA DE CALEFACCIÓN-	CHARTER 3/4"	DETROIT DIESEL 6 CIL, 14.0 L DIESEL	
MANGUERA DE PASO-	CHARTER 1 3/4"	2010	
MANGUERA DE PASO-	CHARTER 3"	BANDA-VENT	K080570
MANGUERA INFERIOR-	CHARTER 2 1/2"	POLEA DEL TENSOR-VENT	38076
MANGUERA SUPERIOR-	CHARTER 2 1/2"	TENSOR-VENT	38503
1991		POLEA DEL TENSOR-TOMA DE FUERZA-ALT-AA	38075
BANDA-VENT	2/9590PB	TENSOR-TOMA DE FUERZA-ALT-AA	38501
BANDA-VENT	8616 GS	MANGUERA SILICÓN-RAD. A TUBO	SIH250363C
BANDA-VENT	PQ17510	MANGUERA SILICÓN-MOTOR A TUBO	SIH250363C
BANDA-VENT	PQ17530	MANGUERA SILICÓN-MOTOR A RAD.	SIH250363C
MANGUERA INFERIOR-TUBO A RAD.	21472	BANDA-AA	K080580
BANDA-ALT-AA	2/9510PB	TERMOSTATO-190°	33599
BANDA-ALT PRESTOLITE	2/9555PB	2009	
BANDA-ALT DELCO	2/9500PB	BANDA-VENT	K080570
BANDA-ALT DELCO	2/9545PB	POLEA DEL TENSOR-VENT	38076
BANDA-ALT	2/9510PB	TENSOR-VENT	38503
BANDA-AA	PQ17530	POLEA DEL TENSOR-TOMA DE FUERZA-ALT-AA	38075
MANGUERA DE CALEFACCIÓN-	35B 5/8"	TENSOR-TOMA DE FUERZA-ALT-AA	38501
MANGUERA DE CALEFACCIÓN-	CHARTER 3/4"	MANGUERA SILICÓN-RAD. A TUBO	SIH250363C
MANGUERA DE PASO-	CHARTER 1 3/4"	MANGUERA SILICÓN-MOTOR A TUBO	SIH250363C
MANGUERA DE PASO-	CHARTER 3"	MANGUERA SILICÓN-MOTOR A RAD.	SIH250363C
MANGUERA INFERIOR-	CHARTER 2 1/2"	BANDA-AA	K080580
MANGUERA SUPERIOR-	CHARTER 2 1/2"	TERMOSTATO-190°	33599
1990		2008	
BANDA-VENT	2/9590PB	BANDA-VENT	K100502
BANDA-VENT	8616 GS	POLEA DEL TENSOR-VENT	38076
BANDA-VENT	PQ17510	TENSOR-VENT	38503
BANDA-VENT	PQ17530	BANDA-TOMA DE FUERZA-ALT-AA	K080570
MANGUERA INFERIOR-TUBO A RAD.	21472	POLEA DEL TENSOR-TOMA DE FUERZA-ALT-AA	38075
BANDA-ALT-AA	2/9510PB	TENSOR-TOMA DE FUERZA-ALT-AA	38501
BANDA-ALT PRESTOLITE	2/9555PB	MANGUERA SILICÓN-RAD. A TUBO	SIH250363C
BANDA-ALT DELCO	2/9500PB	MANGUERA SILICÓN-MOTOR A TUBO	SIH250363C
BANDA-ALT DELCO	2/9545PB	MANGUERA SILICÓN-MOTOR A RAD.	SIH250363C
BANDA-ALT	2/9510PB	TERMOSTATO-190°	33599
BANDA-ALT	PQ17510	2007	
BANDA-AA	PQ17530	BANDA-VENT	K100579
		POLEA DEL TENSOR-VENT	38076



MASTER SERVICIO PESADO 2014

FREIGHTLINER

FLD

TENSOR-VENT	38503	MANGUERA SILICÓN-TUBO A RAD.	SIH250363C
BANDA-TOMA DE FUERZA-ALT-AA	K080565	BANDA-TOMA DE FUERZA-ALT-AA C/ALT 135A	K080570
POLEA DEL TENSOR-TOMA DE FUERZA-ALT-AA	38075	BANDA-TOMA DE FUERZA-ALT-AA C/130 A	K080580
TENSOR-TOMA DE FUERZA-ALT-AA	38501	POLEA DEL TENSOR-TOMA DE FUERZA-ALT-AA	38075
MANGUERA INFERIOR-RAD. A TUBO	21135	TENSOR-TOMA DE FUERZA-ALT-AA	38501
MANGUERA SUPERIOR-RAD. A TUBO	21115	MANGUERA SILICÓN-MOTOR A TUBO	SIH250363C
MANGUERA SILICÓN-MOTOR A TUBO	SIH250363C	TERMOSTATO-190°	33599
TERMOSTATO-190°	33599	2002	
2006		BANDA-VENT- OPCIONAL	9525
BANDA-VENT	K100579	BANDA-VENT	3/9525PB
POLEA DEL TENSOR-VENT	38076	MANGUERA SILICÓN-TUBO A RAD.	SIH250363C
TENSOR-VENT	38503	BANDA-TOMA DE FUERZA-ALT-AA C/ALT 135A	K080575
BANDA-TOMA DE FUERZA-ALT-AA	K080565	BANDA-TOMA DE FUERZA-ALT-AA C/130 A	K080580
POLEA DEL TENSOR-TOMA DE FUERZA-ALT-AA	38075	POLEA DEL TENSOR-TOMA DE FUERZA-ALT-AA	38075
TENSOR-TOMA DE FUERZA-ALT-AA	38501	TENSOR-TOMA DE FUERZA-ALT-AA	38501
MANGUERA INFERIOR-RAD. A TUBO	21135	MANGUERA SILICÓN-MOTOR A TUBO	SIH250363C
MANGUERA SUPERIOR-RAD. A TUBO	21115	TERMOSTATO-190°	33599
MANGUERA SILICÓN-MOTOR A TUBO	SIH250363C	2001	
TERMOSTATO-190°	33599	BANDA-VENT- OPCIONAL	9525
2005		BANDA-VENT	3/9525PB
BANDA-VENT	K100579	MANGUERA SILICÓN-TUBO A RAD.	SIH250363C
POLEA DEL TENSOR-VENT	38076	MANGUERA SILICÓN-TUBO A RAD.	SIH300363C
TENSOR-VENT	38503	BANDA-TOMA DE FUERZA-ALT-AA C/ALT 135A	K080575
BANDA-TOMA DE FUERZA-ALT-AA	K080565	BANDA-TOMA DE FUERZA-ALT-AA C/130 A	K080580
POLEA DEL TENSOR-TOMA DE FUERZA-ALT-AA	38075	POLEA DEL TENSOR-TOMA DE FUERZA-ALT-AA	38075
TENSOR-TOMA DE FUERZA-ALT-AA	38501	TENSOR-TOMA DE FUERZA-ALT-AA	38501
MANGUERA INFERIOR-RAD. A TUBO	21135	MANGUERA SILICÓN-MOTOR A TUBO	SIH250363C
MANGUERA SUPERIOR-RAD. A TUBO	21115	MANGUERA SILICÓN-MOTOR A TUBO	SIH300363C
MANGUERA SILICÓN-MOTOR A TUBO	SIH250363C	TERMOSTATO-190°	33599
TERMOSTATO-190°	33599	DETROIT DIESEL 6 CIL, 12.7 L DIESEL	
2004		2008	
BANDA-VENT- OPCIONAL	9525	BANDA-VENT	K100579
BANDA-VENT	3/9525PB	POLEA DEL TENSOR-VENT	38076
BANDA-VENT	K100579	TENSOR-VENT	38503
MANGUERA SILICÓN-TUBO A RAD.	SIH250363C	BANDA-TOMA DE FUERZA-ALT-AA	K080565
BANDA-TOMA DE FUERZA-ALT-AA	K080570	POLEA DEL TENSOR-TOMA DE FUERZA-ALT-AA	38075
POLEA DEL TENSOR-TOMA DE FUERZA-ALT-AA	38075	TENSOR-TOMA DE FUERZA-ALT-AA	38501
TENSOR-TOMA DE FUERZA-ALT-AA	38501	MANGUERA INFERIOR-RAD. A TUBO	21135
MANGUERA SILICÓN-MOTOR A TUBO	SIH250363C	MANGUERA SUPERIOR-RAD. A TUBO	21115
TERMOSTATO-190°	33599	MANGUERA SILICÓN-MOTOR A TUBO	SIH250363C
2003		TERMOSTATO-190°	33599
BANDA-VENT- OPCIONAL	9525	BOMBA DE AGUA-	44066HD
BANDA-VENT	3/9525PB	2007	



MASTER SERVICIO PESADO 2014

FREIGHTLINER

FLD

BANDA-VENT	K100579	MANGUERA SILICÓN-MOTOR A TUBO	SIH250363C
POLEA DEL TENSOR-VENT	38076	TERMOSTATO-190°	33599
TENSOR-VENT	38503	BOMBA DE AGUA-	44066HD
BANDA-TOMA DE FUERZA-ALT-AA	K080565	2003	
POLEA DEL TENSOR-TOMA DE FUERZA-ALT-AA	38075	BANDA-VENT- OPCIONAL	9525
TENSOR-TOMA DE FUERZA-ALT-AA	38501	BANDA-VENT	3/9525PB
MANGUERA INFERIOR-RAD. A TUBO	21135	MANGUERA SILICÓN-TUBO A RAD.	SIH250363C
MANGUERA SUPERIOR-RAD. A TUBO	21115	BANDA-TOMA DE FUERZA-ALT-AA C/ALT 135A	K080570
MANGUERA SILICÓN-MOTOR A TUBO	SIH250363C	BANDA-TOMA DE FUERZA-ALT-AA C/130 A	K080580
TERMOSTATO-190°	33599	POLEA DEL TENSOR-TOMA DE FUERZA-ALT-AA	38075
BOMBA DE AGUA-	44066HD	TENSOR-TOMA DE FUERZA-ALT-AA	38501
2006		MANGUERA SILICÓN-MOTOR A TUBO	SIH250363C
BANDA-VENT	K100579	TERMOSTATO-190°	33599
POLEA DEL TENSOR-VENT	38076	BOMBA DE AGUA-	44066HD
TENSOR-VENT	38503	2002	
BANDA-TOMA DE FUERZA-ALT-AA	K080565	BANDA-VENT- OPCIONAL	9525
POLEA DEL TENSOR-TOMA DE FUERZA-ALT-AA	38075	BANDA-VENT	3/9525PB
TENSOR-TOMA DE FUERZA-ALT-AA	38501	MANGUERA SILICÓN-TUBO A RAD.	SIH250363C
MANGUERA INFERIOR-RAD. A TUBO	21135	BANDA-TOMA DE FUERZA-ALT-AA C/ALT 135A	K080575
MANGUERA SUPERIOR-RAD. A TUBO	21115	BANDA-TOMA DE FUERZA-ALT-AA C/130 A	K080580
MANGUERA SILICÓN-MOTOR A TUBO	SIH250363C	POLEA DEL TENSOR-TOMA DE FUERZA-ALT-AA	38075
TERMOSTATO-190°	33599	TENSOR-TOMA DE FUERZA-ALT-AA	38501
BOMBA DE AGUA-	44066HD	MANGUERA SILICÓN-MOTOR A TUBO	SIH250363C
2005		TERMOSTATO-190°	33599
BANDA-VENT	K100579	BOMBA DE AGUA-	44066HD
POLEA DEL TENSOR-VENT	38076	2001	
TENSOR-VENT	38503	BANDA-VENT- OPCIONAL	9525
BANDA-TOMA DE FUERZA-ALT-AA	K080565	BANDA-VENT	3/9525PB
POLEA DEL TENSOR-TOMA DE FUERZA-ALT-AA	38075	MANGUERA SILICÓN-TUBO A RAD.	SIH250363C
TENSOR-TOMA DE FUERZA-ALT-AA	38501	MANGUERA SILICÓN-TUBO A RAD.	SIH300363C
MANGUERA INFERIOR-RAD. A TUBO	21135	BANDA-TOMA DE FUERZA-ALT-AA C/ALT 135A	K080575
MANGUERA SUPERIOR-RAD. A TUBO	21115	BANDA-TOMA DE FUERZA-ALT-AA C/130 A	K080580
MANGUERA SILICÓN-MOTOR A TUBO	SIH250363C	POLEA DEL TENSOR-TOMA DE FUERZA-ALT-AA	38075
TERMOSTATO-190°	33599	TENSOR-TOMA DE FUERZA-ALT-AA	38501
BOMBA DE AGUA-	44066HD	MANGUERA SILICÓN-MOTOR A TUBO	SIH250363C
2004		MANGUERA SILICÓN-MOTOR A TUBO	SIH300363C
BANDA-VENT- OPCIONAL	9525	TERMOSTATO-190°	33599
BANDA-VENT	3/9525PB	BOMBA DE AGUA-	44066HD
BANDA-VENT	K100579	2000	
MANGUERA SILICÓN-TUBO A RAD.	SIH250363C	BANDA-VENT- OPCIONAL	9525
BANDA-TOMA DE FUERZA-ALT-AA	K080570	BANDA-VENT	3/9525PB
POLEA DEL TENSOR-TOMA DE FUERZA-ALT-AA	38075	MANGUERA SILICÓN-TUBO A RAD.	SIH250363C
TENSOR-TOMA DE FUERZA-ALT-AA	38501	MANGUERA SILICÓN-TUBO A RAD.	SIH300363C



MASTER SERVICIO PESADO 2014

FREIGHTLINER

FLD

POLEA DEL TENSOR-TOMA DE FUERZA-ALT-AA	38075	1996	
TENSOR-TOMA DE FUERZA-ALT-AA	38501	BANDA-VENT- OPCIONAL	9530
MANGUERA SILICÓN-MOTOR A TUBO	SIH250363C	BANDA-VENT	3/9530PB
BANDA-ALT-BA-AA	9510	BANDA-VENT	9520
BANDA-ALT-BA-AA	K080580	MANGUERA INFERIOR-TUBO A RAD.	21472
TERMOSTATO-190°	33599	MANGUERA SILICÓN-TUBO A RAD.	SIH250363C
BOMBA DE AGUA-	44066HD	MANGUERA SILICÓN-ENTRADA A BA	SIH300363C
1999		BANDA-ALT-AA	2/9545PB
BANDA-VENT	9610	TERMOSTATO-190°	33599
BANDA-VENT	K100502	BOMBA DE AGUA-	44066HD
MANGUERA SILICÓN-TUBO A RAD.	SIH250363C	MANGUERA DE AGUA-	30T 3/4"
MANGUERA SILICÓN-TUBO A RAD.	SIH300363C	MANGUERA DE AGUA-	30T 5/8"
BANDA-TOMA DE FUERZA-ALT-AA	2/9510PB	MANGUERA DE PASO-	CHARTER 1 3/4"
MANGUERA SILICÓN-MOTOR A TUBO	SIH250363C	MANGUERA SILICÓN-	SIH250363C
TERMOSTATO-190°	33599	1995	
BOMBA DE AGUA-	44066HD	BANDA-VENT- OPCIONAL	9530
1998		BANDA-VENT	2/9590PB
BANDA-VENT	9510	BANDA-VENT	3/9530PB
MANGUERA INFERIOR-TUBO A RAD.	21472	BANDA-VENT	9510
MANGUERA SILICÓN-TUBO A RAD.	SIH250363C	BANDA-VENT	9610
BANDA-TOMA DE FUERZA-ALT-AA	2/9510PB	MANGUERA INFERIOR-TUBO A RAD.	21472
MANGUERA SILICÓN-MOTOR A TUBO	SIH250363C	MANGUERA SILICÓN-TUBO A RAD.	SIH250363C
MANGUERA SILICÓN-ENTRADA A BA	SIH300363C	MANGUERA SILICÓN-ENTRADA A BA	SIH300363C
TERMOSTATO-190°	33599	BANDA-ALT-C/ALT PRESTOLITE	2/9555PB
BOMBA DE AGUA-	44066HD	BANDA-ALT-AA	2/9510PB
MANGUERA DE AGUA-	30T 3/4"	BANDA-ALT C/ALT DELCO	2/9500PB
MANGUERA DE AGUA-	30T 5/8"	BANDA-ALT C/ALT DELCO	2/9545PB
MANGUERA DE PASO-	CHARTER 1 3/4"	BANDA-ALT	2/9510PB
1997		BANDA-	9530
BANDA-VENT-OPCIONAL	3/9530PB	BOMBA DE AGUA-	44066HD
BANDA-VENT- OPCIONAL	9530	MANGUERA DE AGUA-	30T 3/4"
BANDA-VENT	9510	MANGUERA DE AGUA-	30T 5/8"
MANGUERA INFERIOR-TUBO A RAD.	21472	MANGUERA DE PASO-	CHARTER 1 3/4"
MANGUERA SILICÓN-TUBO A RAD.	SIH250363C	MANGUERA SILICÓN-	SIH250363C
MANGUERA SILICÓN-TUBO A RAD.	SIH300363C	1994	
BANDA-TOMA DE FUERZA-ALT-AA	2/9510PB	BANDA-VENT- OPCIONAL	9530
MANGUERA SILICÓN-MOTOR A TUBO	SIH250363C	BANDA-VENT	2/9590PB
MANGUERA SILICÓN-ENTRADA A BA	SIH300363C	BANDA-VENT	3/9530PB
TERMOSTATO-190°	33599	BANDA-VENT	9510
BOMBA DE AGUA-	44066HD	BANDA-VENT	9530
MANGUERA DE AGUA-	30T 3/4"	BANDA-VENT	9610
MANGUERA DE AGUA-	30T 5/8"	MANGUERA INFERIOR-TUBO A RAD.	21472
MANGUERA DE PASO-	CHARTER 1 3/4"	MANGUERA SILICÓN-TUBO A RAD.	SIH250363C



MASTER SERVICIO PESADO 2014

FREIGHTLINER

FLD

MANGUERA SILICÓN-ENTRADA A BA	SIH300363C	MANGUERA SILICÓN-ENTRADA A BA	SIH300363C
BANDA-ALT-VENT-AA	9510	BANDA-ALT-C/ALT PRESTOLITE	2/9555PB
BANDA-ALT-C/ALT PRESTOLITE	2/9555PB	BANDA-ALT-AA	2/9510PB
BANDA-ALT-AA	2/9510PB	BANDA-ALT C/ALT DELCO	2/9500PB
BANDA-ALT C/ALT DELCO	2/9500PB	BANDA-ALT C/ALT DELCO	2/9545PB
BANDA-ALT C/ALT DELCO	2/9545PB	BANDA-ALT	2/9510PB
BANDA-ALT	2/9510PB	BANDA-AA	9530
BANDA-	9530	BOMBA DE AGUA-	44066HD
BOMBA DE AGUA-	44066HD	MANGUERA DE AGUA-	30T 3/4"
MANGUERA DE AGUA-	30T 3/4"	MANGUERA DE AGUA-	30T 5/8"
MANGUERA DE AGUA-	30T 5/8"	MANGUERA DE PASO-	CHARTER 1 3/4"
MANGUERA DE PASO-	CHARTER 1 3/4"	MANGUERA SILICÓN-	SIH250363C
MANGUERA SILICÓN-	SIH250363C	1991	
1993		BANDA-VENT	2/9590PB
BANDA-VENT- OPCIONAL	9530	BANDA-VENT	3/9530PB
BANDA-VENT	2/9590PB	BANDA-VENT	9510
BANDA-VENT	3/9530PB	BANDA-VENT	9530
BANDA-VENT	9510	BANDA-VENT	9610
BANDA-VENT	9530	MANGUERA INFERIOR-TUBO A RAD.	21472
BANDA-VENT	9610	MANGUERA SILICÓN-TUBO A RAD.	SIH250363C
MANGUERA INFERIOR-TUBO A RAD.	21472	MANGUERA SILICÓN-ENTRADA A BA	SIH300363C
MANGUERA SILICÓN-TUBO A RAD.	SIH250363C	BANDA-ALT-C/ALT PRESTOLITE	2/9555PB
MANGUERA SILICÓN-ENTRADA A BA	SIH300363C	BANDA-ALT-AA	2/9510PB
BANDA-ALT-C/ALT PRESTOLITE	2/9555PB	BANDA-ALT C/ALT DELCO	2/9500PB
BANDA-ALT-AA	2/9510PB	BANDA-ALT C/ALT DELCO	2/9545PB
BANDA-ALT C/ALT DELCO	2/9500PB	BANDA-ALT	2/9510PB
BANDA-ALT C/ALT DELCO	2/9545PB	BANDA-AA	9530
BANDA-ALT	2/9510PB	BOMBA DE AGUA-	44066HD
BANDA-	9530	MANGUERA DE AGUA-	30T 3/4"
BOMBA DE AGUA-	44066HD	MANGUERA DE AGUA-	30T 5/8"
MANGUERA DE AGUA-	30T 3/4"	MANGUERA DE PASO-	CHARTER 1 3/4"
MANGUERA DE AGUA-	30T 5/8"	MANGUERA SILICÓN-	SIH250363C
MANGUERA DE PASO-	CHARTER 1 3/4"	DETROIT DIESEL 6 CIL, 11.1 L DIESEL	
MANGUERA SILICÓN-	SIH250363C	2002	
1992		BANDA-VENT- OPCIONAL	9525
BANDA-VENT	2/9590PB	BANDA-VENT	3/9525PB
BANDA-VENT	3/9530PB	MANGUERA SILICÓN-TUBO A RAD.	SIH250363C
BANDA-VENT	9510	BANDA-TOMA DE FUERZA-ALT-AA C/ALT 135A	K080575
BANDA-VENT	9530	BANDA-TOMA DE FUERZA-ALT-AA C/130 A	K080580
BANDA-VENT	9610	POLEA DEL TENSOR-TOMA DE FUERZA-ALT-AA	38075
MANGUERA INFERIOR-TUBO A RAD.	21472	TENSOR-TOMA DE FUERZA-ALT-AA	38501
MANGUERA SILICÓN-TUBO A RAD.	SIH250363C	MANGUERA SILICÓN-MOTOR A TUBO	SIH250363C
		TERMOSTATO-190°	33599



MASTER SERVICIO PESADO 2014

FREIGHTLINER

FLD

2001			
BANDA-VENT- OPCIONAL	9525	BANDA-VENT- OPCIONAL	3/9530PB
BANDA-VENT	3/9525PB	BANDA-VENT	9530
MANGUERA SILICÓN-TUBO A RAD.	SIH250363C	MANGUERA INFERIOR-TUBO A RAD.	9510
MANGUERA SILICÓN-TUBO A RAD.	SIH300363C	MANGUERA SILICÓN-TUBO A RAD.	21472
BANDA-TOMA DE FUERZA-ALT-AA C/ALT 135A	K080575	MANGUERA SILICÓN-TUBO A RAD.	SIH250363C
BANDA-TOMA DE FUERZA-ALT-AA C/130 A	K080580	MANGUERA SILICÓN-TUBO A RAD.	SIH300363C
POLEA DEL TENSOR-TOMA DE FUERZA-ALT-AA	38075	BANDA-TOMA DE FUERZA-ALT-AA	2/9510PB
TENSOR-TOMA DE FUERZA-ALT-AA	38501	MANGUERA SILICÓN-MOTOR A TUBO	SIH250363C
MANGUERA SILICÓN-MOTOR A TUBO	SIH250363C	MANGUERA SILICÓN-ENTRADA A BA	SIH300363C
MANGUERA SILICÓN-MOTOR A TUBO	SIH300363C	TERMOSTATO-190°	33599
TERMOSTATO-190°	33599	MANGUERA DE AGUA-	30T 3/4"
		MANGUERA DE AGUA-	30T 5/8"
		MANGUERA DE PASO-	CHARTER 1 3/4"
2000		1996	
BANDA-VENT- OPCIONAL	9525	BANDA-VENT- OPCIONAL	9530
BANDA-VENT	3/9525PB	BANDA-VENT	3/9530PB
MANGUERA SILICÓN-TUBO A RAD.	SIH250363C	BANDA-VENT	9520
MANGUERA SILICÓN-TUBO A RAD.	SIH300363C	MANGUERA INFERIOR-TUBO A RAD.	21472
POLEA DEL TENSOR-TOMA DE FUERZA-ALT-AA	38075	MANGUERA SILICÓN-TUBO A RAD.	SIH250363C
TENSOR-TOMA DE FUERZA-ALT-AA	38501	MANGUERA SILICÓN-ENTRADA A BA	SIH300363C
MANGUERA SILICÓN-MOTOR A TUBO	SIH250363C	BANDA-ALT-AA	2/9545PB
BANDA-ALT-BA-AA	9510	TERMOSTATO-190°	33599
BANDA-ALT-BA-AA	K080580	MANGUERA DE AGUA-	30T 3/4"
TERMOSTATO-190°	33599	MANGUERA DE AGUA-	30T 5/8"
		MANGUERA DE PASO-	CHARTER 1 3/4"
1999		MANGUERA SILICÓN-	SIH250363C
BANDA-VENT	9610	1995	
BANDA-VENT	K100502	BANDA-VENT- OPCIONAL	9530
MANGUERA SILICÓN-TUBO A RAD.	SIH250363C	BANDA-VENT	2/9590PB
MANGUERA SILICÓN-TUBO A RAD.	SIH300363C	BANDA-VENT	3/9530PB
BANDA-TOMA DE FUERZA-ALT-AA	2/9510PB	BANDA-VENT	9510
MANGUERA SILICÓN-MOTOR A TUBO	SIH250363C	BANDA-VENT	9610
TERMOSTATO-190°	33599	MANGUERA INFERIOR-TUBO A RAD.	21472
		MANGUERA SILICÓN-TUBO A RAD.	SIH250363C
1998		MANGUERA SILICÓN-ENTRADA A BA	SIH300363C
BANDA-VENT	9510	BANDA-ALT-C/ALT PRESTOLITE	2/9555PB
MANGUERA INFERIOR-TUBO A RAD.	21472	BANDA-ALT-AA	2/9510PB
MANGUERA SILICÓN-TUBO A RAD.	SIH250363C	BANDA-ALT C/ALT DELCO	2/9500PB
BANDA-TOMA DE FUERZA-ALT-AA	2/9510PB	BANDA-ALT C/ALT DELCO	2/9545PB
MANGUERA SILICÓN-MOTOR A TUBO	SIH250363C	BANDA-ALT	2/9510PB
MANGUERA SILICÓN-ENTRADA A BA	SIH300363C	TERMOSTATO-190°	33599
TERMOSTATO-190°	33599	BANDA-	9530
MANGUERA DE AGUA-	30T 3/4"		
MANGUERA DE AGUA-	30T 5/8"		
MANGUERA DE PASO-	CHARTER 1 3/4"		
1997			



MASTER SERVICIO PESADO 2014

FREIGHTLINER

FLD

MANGUERA DE AGUA-	30T 3/4"	BANDA-	9530
MANGUERA DE AGUA-	30T 5/8"	MANGUERA DE AGUA-	30T 3/4"
MANGUERA DE PASO-	CHARTER 1 3/4"	MANGUERA DE AGUA-	30T 5/8"
MANGUERA SILICÓN-	SIH250363C	MANGUERA DE PASO-	CHARTER 1 3/4"
1994		MANGUERA SILICÓN-	SIH250363C
BANDA-VENT- OPCIONAL	9530	1992	
BANDA-VENT	2/9590PB	BANDA-VENT	2/9590PB
BANDA-VENT	3/9530PB	BANDA-VENT	3/9530PB
BANDA-VENT	9510	BANDA-VENT	9510
BANDA-VENT	9530	BANDA-VENT	9530
BANDA-VENT	9610	BANDA-VENT	9610
MANGUERA INFERIOR-TUBO A RAD.	21472	MANGUERA INFERIOR-TUBO A RAD.	21472
MANGUERA SILICÓN-TUBO A RAD.	SIH250363C	MANGUERA SILICÓN-TUBO A RAD.	SIH250363C
MANGUERA SILICÓN-ENTRADA A BA	SIH300363C	MANGUERA SILICÓN-ENTRADA A BA	SIH300363C
BANDA-ALT-VENT-AA	9510	BANDA-ALT-C/ALT PRESTOLITE	2/9555PB
BANDA-ALT-C/ALT PRESTOLITE	2/9555PB	BANDA-ALT-AA	2/9510PB
BANDA-ALT-AA	2/9510PB	BANDA-ALT C/ALT DELCO	2/9500PB
BANDA-ALT C/ALT DELCO	2/9500PB	BANDA-ALT C/ALT DELCO	2/9545PB
BANDA-ALT C/ALT DELCO	2/9545PB	BANDA-ALT	2/9510PB
BANDA-ALT	2/9510PB	BANDA-AA	9530
TERMOSTATO-190°	33599	TERMOSTATO-190°	33599
BANDA-	9530	MANGUERA DE AGUA-	30T 3/4"
MANGUERA DE AGUA-	30T 3/4"	MANGUERA DE AGUA-	30T 5/8"
MANGUERA DE AGUA-	30T 5/8"	MANGUERA DE PASO-	CHARTER 1 3/4"
MANGUERA DE PASO-	CHARTER 1 3/4"	MANGUERA SILICÓN-	SIH250363C
MANGUERA SILICÓN-	SIH250363C	1991	
1993		BANDA-VENT	2/9590PB
BANDA-VENT- OPCIONAL	9530	BANDA-VENT	3/9530PB
BANDA-VENT	2/9590PB	BANDA-VENT	9510
BANDA-VENT	3/9530PB	BANDA-VENT	9530
BANDA-VENT	9510	BANDA-VENT	9610
BANDA-VENT	9530	MANGUERA INFERIOR-TUBO A RAD.	21472
BANDA-VENT	9610	MANGUERA SILICÓN-TUBO A RAD.	SIH250363C
MANGUERA INFERIOR-TUBO A RAD.	21472	MANGUERA SILICÓN-ENTRADA A BA	SIH300363C
MANGUERA SILICÓN-TUBO A RAD.	SIH250363C	BANDA-ALT-C/ALT PRESTOLITE	2/9555PB
MANGUERA SILICÓN-ENTRADA A BA	SIH300363C	BANDA-ALT-AA	2/9510PB
BANDA-ALT-C/ALT PRESTOLITE	2/9555PB	BANDA-ALT C/ALT DELCO	2/9500PB
BANDA-ALT-AA	2/9510PB	BANDA-ALT C/ALT DELCO	2/9545PB
BANDA-ALT C/ALT DELCO	2/9500PB	BANDA-ALT	2/9510PB
BANDA-ALT C/ALT DELCO	2/9545PB	BANDA-AA	9530
BANDA-ALT	2/9510PB	TERMOSTATO-190°	33599
TERMOSTATO-190°	33599	MANGUERA DE AGUA-	30T 3/4"



MASTER SERVICIO PESADO 2014

FREIGHTLINER

FLD

MANGUERA DE AGUA-	30T 5/8"	MANGUERA SUPERIOR-MOTOR A TUBO	CHARTER 2 1/2"
MANGUERA DE PASO-	CHARTER 1 3/4"	BANDA-ALT	9451
MANGUERA SILICÓN-	SIH250363C	TERMOSTATO-190°	33579
CUMMINS SIGNATURE 600 DIESEL		TERMOSTATO-180°	33576
1999		TERMOSTATO-180°	33578
BANDA-BA-VENT	K150759	TERMOSTATO-170°	33577
BANDA-ALT-AA	K060660	2002	
1998		BANDA-VENT	2/TR28466PB
BANDA-BA-VENT	K150759	MANGUERA INFERIOR-TUBO A RAD.	CHARTER 3"
BANDA-ALT-AA	K060660	MANGUERA SUPERIOR-TUBO A RAD.	CHARTER 2 1/2"
CUMMINS N14 DIESEL		BANDA-TOMA DE FUERZA-BA	K060425
2008		BANDA-TOMA DE FUERZA-AA	9435
TERMOSTATO-190°	33579	MANGUERA INFERIOR-MOTOR A TUBO	CHARTER 2 1/2"
TERMOSTATO-180°	33576	MANGUERA SUPERIOR-MOTOR A TUBO	CHARTER 2 1/2"
TERMOSTATO-180°	33578	BANDA-ALT	9451
TERMOSTATO-170°	33577	TERMOSTATO-190°	33579
2007		TERMOSTATO-180°	33576
TERMOSTATO-190°	33579	TERMOSTATO-180°	33578
TERMOSTATO-180°	33576	TERMOSTATO-170°	33577
TERMOSTATO-180°	33578	2001	
TERMOSTATO-170°	33577	MANGUERA SILICÓN-TUBO A RAD.	SIH250363C
2006		MANGUERA SILICÓN-TUBO A RAD.	SIH300363C
TERMOSTATO-190°	33579	MANGUERA SUPERIOR-TUBO A RAD.	CHARTER 2 1/2"
TERMOSTATO-180°	33576	BANDA-TOMA DE FUERZA-VENT	PQ28429
TERMOSTATO-180°	33578	BANDA-TOMA DE FUERZA-VENT	TR28429
TERMOSTATO-170°	33577	BANDA-TOMA DE FUERZA-BA	K060425
2005		BANDA-TOMA DE FUERZA-AA	9435
TERMOSTATO-190°	33579	BANDA-TOMA DE FUERZA-AA	PQ17440
TERMOSTATO-180°	33576	MANGUERA SILICÓN-MOTOR A TUBO	SIH250363C
TERMOSTATO-180°	33578	MANGUERA SUPERIOR-MOTOR A TUBO	CHARTER 2 1/2"
TERMOSTATO-170°	33577	BANDA-ALT	9451
2004		BANDA-ALT	PQ17450
TERMOSTATO-190°	33579	TERMOSTATO-190°	33579
TERMOSTATO-180°	33576	TERMOSTATO-180°	33576
TERMOSTATO-180°	33578	TERMOSTATO-180°	33578
TERMOSTATO-170°	33577	TERMOSTATO-170°	33577
2003		MANGUERA INFERIOR-	CHARTER 2 1/2"
BANDA-VENT	2/TR28466PB	MANGUERA INFERIOR-	CHARTER 3"
MANGUERA INFERIOR-TUBO A RAD.	CHARTER 3"	2000	
MANGUERA SUPERIOR-TUBO A RAD.	CHARTER 2 1/2"	MANGUERA SILICÓN-TUBO A RAD.	SIH250363C
BANDA-TOMA DE FUERZA-BA	K060425	MANGUERA SILICÓN-TUBO A RAD.	SIH300363C
BANDA-TOMA DE FUERZA-AA	9435	MANGUERA SUPERIOR-TUBO A RAD.	CHARTER 2 1/2"
MANGUERA INFERIOR-MOTOR A TUBO	CHARTER 2 1/2"	BANDA-TOMA DE FUERZA-VENT	PQ28429



MASTER SERVICIO PESADO 2014

FREIGHTLINER

FLD

BANDA-TOMA DE FUERZA-VENT	TR28429	MANGUERA SILICÓN-MOTOR A TUBO	SIH250363C
BANDA-TOMA DE FUERZA-BA	K060425	MANGUERA SUPERIOR-MOTOR A TUBO	CHARTER 2 1/2"
BANDA-TOMA DE FUERZA-AA	9435	BANDA-ALT	9463
BANDA-TOMA DE FUERZA-AA	PQ17440	BANDA-ALT	PQ17460
MANGUERA SILICÓN-MOTOR A TUBO	SIH250363C	TERMOSTATO-190°	33579
MANGUERA SUPERIOR-MOTOR A TUBO	CHARTER 2 1/2"	TERMOSTATO-180°	33576
BANDA-ALT	9463	TERMOSTATO-180°	33578
BANDA-ALT	PQ17460	TERMOSTATO-170°	33577
TERMOSTATO-190°	33579	MANGUERA INFERIOR-	CHARTER 2 1/2"
TERMOSTATO-180°	33576	1997	
TERMOSTATO-180°	33578	MANGUERA SILICÓN-TUBO A RAD.	SIH250363C
TERMOSTATO-170°	33577	MANGUERA SUPERIOR-TUBO A RAD.	CHARTER 2 1/2"
MANGUERA INFERIOR-	CHARTER 2 1/2"	BANDA-TOMA DE FUERZA-VENT	PQ28429
MANGUERA INFERIOR-	CHARTER 3"	BANDA-TOMA DE FUERZA-VENT	TR28429
1999		BANDA-TOMA DE FUERZA-BA	K060425
MANGUERA SILICÓN-TUBO A RAD.	SIH250363C	BANDA-TOMA DE FUERZA-AA	2/9435PB
MANGUERA SILICÓN-TUBO A RAD.	SIH300363C	BANDA-TOMA DE FUERZA-AA	9435
MANGUERA SUPERIOR-TUBO A RAD.	CHARTER 2 1/2"	BANDA-TOMA DE FUERZA-AA	PQ17440
BANDA-TOMA DE FUERZA-VENT	PQ28429	MANGUERA SILICÓN-SIN POSTENFRIADOR	SIH250363C
BANDA-TOMA DE FUERZA-VENT	TR28429	MANGUERA DE ENFRIAMIENTO-POSTENFRIADOR	21488
BANDA-TOMA DE FUERZA-BA	K060425	MANGUERA DE PASO-POSTENFRIADOR	21488
BANDA-TOMA DE FUERZA-AA	9435	MANGUERA SILICÓN-MOTOR A TUBO	SIH250363C
BANDA-TOMA DE FUERZA-AA	PQ17440	MANGUERA SUPERIOR-MOTOR A TUBO	CHARTER 2 1/2"
MANGUERA SILICÓN-MOTOR A TUBO	SIH250363C	MANGUERA SILICÓN-CON POSTENFRIADOR	SIH300363C
MANGUERA SUPERIOR-MOTOR A TUBO	CHARTER 2 1/2"	BANDA-ALT	9463
BANDA-ALT	9463	BANDA-ALT	PQ17460
BANDA-ALT	PQ17460	TERMOSTATO-190°	33579
TERMOSTATO-190°	33579	TERMOSTATO-180°	33576
TERMOSTATO-180°	33576	TERMOSTATO-180°	33578
TERMOSTATO-180°	33578	TERMOSTATO-170°	33577
TERMOSTATO-170°	33577	MANGUERA DE AGUA-	30T 3/4"
MANGUERA INFERIOR-	CHARTER 2 1/2"	MANGUERA DE CALEFACCIÓN-	CHARTER 3/4"
MANGUERA INFERIOR-	CHARTER 3"	MANGUERA DE PASO-	CHARTER 1 1/2"
1998		MANGUERA INFERIOR-	CHARTER 1 1/4"
MANGUERA SILICÓN-TUBO A RAD.	SIH250363C	MANGUERA INFERIOR-	CHARTER 2 1/2"
MANGUERA SUPERIOR-TUBO A RAD.	CHARTER 2 1/2"	MANGUERA INFERIOR-	CHARTER 3"
BANDA-TOMA DE FUERZA-VENT	PQ28429	MANGUERA SUPERIOR-	26510
BANDA-TOMA DE FUERZA-VENT	TR28429	MANGUERA SUPERIOR FLEXIBLE-	2T170
BANDA-TOMA DE FUERZA-BA	K060425	1996	
BANDA-TOMA DE FUERZA-AA	2/9435PB	BANDA-VENT- OPCIONAL	TR28429
BANDA-TOMA DE FUERZA-AA	9435	BANDA-VENT- OPCIONAL	TR28437
BANDA-TOMA DE FUERZA-AA	PQ17440	BANDA-VENT- OPCIONAL	TR28473



MASTER SERVICIO PESADO 2014

FREIGHTLINER

FLD

BANDA-VENT- OPCIONAL	TR28480	TERMOSTATO-170°	33577
BANDA-VENT- OPCIONAL	TR28492	BANDA-	9405
BANDA-VENT	2/TR28429PB	BANDA-	9412
BANDA-VENT	2/TR28437PB	BANDA-	9420
BANDA-VENT	2/TR28473PB	BANDA-	9425
BANDA-VENT	2/TR28480PB	BANDA-	9430
BANDA-VENT	2/TR28492PB	BANDA-	9435
BANDA-VENT	PQ28429	BANDA-	9447
BANDA-VENT	PQ28437	BANDA-	9451
BANDA-VENT	PQ28445	BANDA-	9545
BANDA-VENT	PQ28473	MANGUERA DE AGUA-	30T 3/4"
BANDA-VENT	PQ28480	MANGUERA DE CALEFACCIÓN-	CHARTER 3/4"
BANDA-VENT	PQ28492	MANGUERA DE PASO-	CHARTER 1 1/2"
BANDA-VENT	TR28445	MANGUERA INFERIOR-	CHARTER 1 1/4"
MANGUERA SILICÓN-SIN POSTENFRIADOR	SIH200363C	MANGUERA INFERIOR-	CHARTER 2 1/2"
MANGUERA SILICÓN-SIN POSTENFRIADOR	SIH250363C	MANGUERA INFERIOR-	CHARTER 3"
MANGUERA DE ENFRIAMIENTO-POSTENFRIADOR	21488	MANGUERA SUPERIOR-	26510
MANGUERA DE PASO-POSTENFRIADOR	21488	MANGUERA SUPERIOR-	CHARTER 2 1/2"
MANGUERA SILICÓN-CON POSTENFRIADOR	SIH250363C	MANGUERA SUPERIOR-	CHARTER 2"
MANGUERA SILICÓN-CON POSTENFRIADOR	SIH300363C	MANGUERA SUPERIOR FLEXIBLE-	2T170
BANDA-BA	K040430	1995	
BANDA-BA	K040445	BANDA-VENT- OPCIONAL	TR28429
BANDA-ALT-C/ALT 90A	2/9451PB	BANDA-VENT- OPCIONAL	TR28437
BANDA-ALT-C/ALT 90A	9451	BANDA-VENT- OPCIONAL	TR28473
BANDA-ALT 90A	2/9451PB	BANDA-VENT- OPCIONAL	TR28480
BANDA-ALT 90A	PQ17450	BANDA-VENT- OPCIONAL	TR28492
BANDA-ALT	2/9463PB	BANDA-VENT	2/TR28429PB
BANDA-ALT	2/TR28501PB	BANDA-VENT	2/TR28437PB
BANDA-ALT	9463	BANDA-VENT	2/TR28473PB
BANDA-ALT	PQ17460	BANDA-VENT	2/TR28480PB
BANDA-ALT	PQ28501	BANDA-VENT	2/TR28492PB
BANDA-ALT	TR28501	BANDA-VENT	PQ28429
BANDA-AA	8405 GS	BANDA-VENT	PQ28437
BANDA-AA	8416 GS	BANDA-VENT	PQ28445
BANDA-AA	PQ17420	BANDA-VENT	PQ28473
BANDA-AA	PQ17430	BANDA-VENT	PQ28480
BANDA-AA	PQ17440	BANDA-VENT	PQ28492
BANDA-AA	PQ17450	BANDA-VENT	TR28445
BANDA-AA	PQ17550	MANGUERA SILICÓN-SIN POSTENFRIADOR	SIH200363C
TERMOSTATO-190°	33579	MANGUERA SILICÓN-SIN POSTENFRIADOR	SIH250363C
TERMOSTATO-180°	33576	MANGUERA DE ENFRIAMIENTO-POSTENFRIADOR	21488
TERMOSTATO-180°	33578	MANGUERA DE PASO-POSTENFRIADOR	21488



MASTER SERVICIO PESADO 2014

FREIGHTLINER

FLD

MANGUERA SILICÓN-CON POSTENFRIADOR	SIH250363C	MANGUERA SUPERIOR-	CHARTER 2"
MANGUERA SILICÓN-CON POSTENFRIADOR	SIH300363C	MANGUERA SUPERIOR FLEXIBLE-	2T170
BANDA-BA	K040430	1994	
BANDA-BA	K040445	BANDA-VENT- OPCIONAL	TR28429
BANDA-ALT-C/ALT 90A	2/9451PB	BANDA-VENT- OPCIONAL	TR28437
BANDA-ALT-C/ALT 90A	9451	BANDA-VENT- OPCIONAL	TR28473
BANDA-ALT 90A	2/9451PB	BANDA-VENT- OPCIONAL	TR28480
BANDA-ALT 90A	PQ17450	BANDA-VENT- OPCIONAL	TR28492
BANDA-ALT	2/9463PB	BANDA-VENT	2/TR28429PB
BANDA-ALT	2/TR28501PB	BANDA-VENT	2/TR28437PB
BANDA-ALT	9463	BANDA-VENT	2/TR28473PB
BANDA-ALT	PQ17460	BANDA-VENT	2/TR28480PB
BANDA-ALT	PQ28501	BANDA-VENT	2/TR28492PB
BANDA-ALT	TR28501	BANDA-VENT	PQ28429
BANDA-AA	8405 GS	BANDA-VENT	PQ28437
BANDA-AA	8416 GS	BANDA-VENT	PQ28445
BANDA-AA	PQ17420	BANDA-VENT	PQ28473
BANDA-AA	PQ17430	BANDA-VENT	PQ28480
BANDA-AA	PQ17440	BANDA-VENT	PQ28492
BANDA-AA	PQ17450	BANDA-VENT	TR28445
BANDA-AA	PQ17540	MANGUERA SILICÓN-SIN POSTENFRIADOR	SIH200363C
TERMOSTATO-190°	33579	MANGUERA SILICÓN-SIN POSTENFRIADOR	SIH250363C
TERMOSTATO-180°	33576	MANGUERA DE ENFRIAMIENTO-POSTENFRIADOR	21488
TERMOSTATO-180°	33578	MANGUERA DE PASO-POSTENFRIADOR	21488
TERMOSTATO-170°	33577	MANGUERA SILICÓN-CON POSTENFRIADOR	SIH250363C
BANDA-	9405	MANGUERA SILICÓN-CON POSTENFRIADOR	SIH300363C
BANDA-	9412	BANDA-BA	K040430
BANDA-	9420	BANDA-BA	K040445
BANDA-	9425	BANDA-BA	K060425
BANDA-	9430	BANDA-ALT-C/ALT 90A	2/9451PB
BANDA-	9435	BANDA-ALT-C/ALT 90A	9451
BANDA-	9447	BANDA-ALT 90A	2/9451PB
BANDA-	9451	BANDA-ALT 90A	PQ17450
BANDA-	9540	BANDA-ALT	2/9463PB
MANGUERA DE AGUA-	30T 3/4"	BANDA-ALT	2/TR28501PB
MANGUERA DE CALEFACCIÓN-	CHARTER 3/4"	BANDA-ALT	9463
MANGUERA DE PASO-	CHARTER 1 1/2"	BANDA-ALT	PQ17460
MANGUERA INFERIOR-	CHARTER 1 1/4"	BANDA-ALT	PQ28501
MANGUERA INFERIOR-	CHARTER 2 1/2"	BANDA-ALT	TR28501
MANGUERA INFERIOR-	CHARTER 3"	BANDA-AA	8405 GS
MANGUERA SUPERIOR-	26510	BANDA-AA	8416 GS
MANGUERA SUPERIOR-	CHARTER 2 1/2"	BANDA-AA	PQ17420



MASTER SERVICIO PESADO 2014

FREIGHTLINER

FLD

BANDA-AA	PQ17430	BANDA-VENT	PQ28480
BANDA-AA	PQ17440	BANDA-VENT	PQ28492
BANDA-AA	PQ17450	BANDA-VENT	TR28445
BANDA-AA	PQ17540	MANGUERA SILICÓN-SIN POSTENFRIADOR	SIH200363C
TERMOSTATO-190°	33579	MANGUERA SILICÓN-SIN POSTENFRIADOR	SIH250363C
TERMOSTATO-180°	33576	MANGUERA DE ENFRIAMIENTO-POSTENFRIADOR	21488
TERMOSTATO-180°	33578	MANGUERA DE PASO-POSTENFRIADOR	21488
TERMOSTATO-170°	33577	MANGUERA SILICÓN-CON POSTENFRIADOR	SIH250363C
BANDA-	9405	MANGUERA SILICÓN-CON POSTENFRIADOR	SIH300363C
BANDA-	9412	BANDA-BA	K040430
BANDA-	9420	BANDA-BA	K040445
BANDA-	9425	BANDA-BA	K060425
BANDA-	9430	BANDA-BA	K060435
BANDA-	9435	BANDA-ALT-C/ALT 90A	2/9451PB
BANDA-	9447	BANDA-ALT-C/ALT 90A	9451
BANDA-	9451	BANDA-ALT 90A	2/9451PB
BANDA-	9540	BANDA-ALT 90A	PQ17450
MANGUERA DE AGUA-	30T 3/4"	BANDA-ALT	2/9463PB
MANGUERA DE CALEFACCIÓN-	CHARTER 3/4"	BANDA-ALT	2/TR28501PB
MANGUERA DE PASO-	CHARTER 1 1/2"	BANDA-ALT	9463
MANGUERA INFERIOR-	CHARTER 1 1/4"	BANDA-ALT	PQ17460
MANGUERA INFERIOR-	CHARTER 2 1/2"	BANDA-ALT	PQ28501
MANGUERA INFERIOR-	CHARTER 3"	BANDA-ALT	TR28501
MANGUERA SUPERIOR-	26510	BANDA-AA	8405 GS
MANGUERA SUPERIOR-	CHARTER 2 1/2"	BANDA-AA	8416 GS
MANGUERA SUPERIOR-	CHARTER 2"	BANDA-AA	9405
MANGUERA SUPERIOR FLEXIBLE-	2T170	BANDA-AA	9412
1993		BANDA-AA	9420
BANDA-VENT- OPCIONAL	TR28429	BANDA-AA	9425
BANDA-VENT- OPCIONAL	TR28437	BANDA-AA	9430
BANDA-VENT- OPCIONAL	TR28473	BANDA-AA	9435
BANDA-VENT- OPCIONAL	TR28480	BANDA-AA	9447
BANDA-VENT- OPCIONAL	TR28492	BANDA-AA	9451
BANDA-VENT	2/TR28429PB	BANDA-AA	PQ17420
BANDA-VENT	2/TR28437PB	BANDA-AA	PQ17430
BANDA-VENT	2/TR28473PB	BANDA-AA	PQ17440
BANDA-VENT	2/TR28480PB	BANDA-AA	PQ17450
BANDA-VENT	2/TR28492PB	BANDA-AA	PQ17540
BANDA-VENT	PQ28429	TERMOSTATO-190°	33579
BANDA-VENT	PQ28437	TERMOSTATO-180°	33576
BANDA-VENT	PQ28445	TERMOSTATO-180°	33578
BANDA-VENT	PQ28473	TERMOSTATO-170°	33577



MASTER SERVICIO PESADO 2014

FREIGHTLINER

FLD

BANDA-	9540	BANDA-ALT	2/9463PB
MANGUERA DE AGUA-	30T 3/4"	BANDA-ALT	2/TR28501PB
MANGUERA DE CALEFACCIÓN-	CHARTER 3/4"	BANDA-ALT	9463
MANGUERA DE PASO-	CHARTER 1 1/2"	BANDA-ALT	PQ17460
MANGUERA INFERIOR-	CHARTER 1 1/4"	BANDA-ALT	PQ28501
MANGUERA INFERIOR-	CHARTER 2 1/2"	BANDA-ALT	TR28501
MANGUERA INFERIOR-	CHARTER 3"	BANDA-AA	8405 GS
MANGUERA SUPERIOR-	26510	BANDA-AA	8416 GS
MANGUERA SUPERIOR-	CHARTER 2 1/2"	BANDA-AA	9405
MANGUERA SUPERIOR-	CHARTER 2"	BANDA-AA	9412
MANGUERA SUPERIOR FLEXIBLE-	2T170	BANDA-AA	9420
1992		BANDA-AA	9425
BANDA-VENT	2/TR28429PB	BANDA-AA	9430
BANDA-VENT	2/TR28437PB	BANDA-AA	9435
BANDA-VENT	2/TR28473PB	BANDA-AA	9447
BANDA-VENT	2/TR28480PB	BANDA-AA	9451
BANDA-VENT	2/TR28492PB	BANDA-AA	9540
BANDA-VENT	PQ28429	BANDA-AA	PQ17420
BANDA-VENT	PQ28437	BANDA-AA	PQ17430
BANDA-VENT	PQ28445	BANDA-AA	PQ17440
BANDA-VENT	PQ28473	BANDA-AA	PQ17450
BANDA-VENT	PQ28480	BANDA-AA	PQ17540
BANDA-VENT	PQ28492	TERMOSTATO-190°	33579
BANDA-VENT	TR28429	TERMOSTATO-180°	33576
BANDA-VENT	TR28437	TERMOSTATO-180°	33578
BANDA-VENT	TR28445	TERMOSTATO-170°	33577
BANDA-VENT	TR28473	MANGUERA DE AGUA-	30T 3/4"
BANDA-VENT	TR28480	MANGUERA DE CALEFACCIÓN-	CHARTER 3/4"
BANDA-VENT	TR28492	MANGUERA DE PASO-	CHARTER 1 1/2"
MANGUERA SILICÓN-SIN POSTENFRIADOR	SIH200363C	MANGUERA INFERIOR-	CHARTER 1 1/4"
MANGUERA SILICÓN-SIN POSTENFRIADOR	SIH250363C	MANGUERA INFERIOR-	CHARTER 2 1/2"
MANGUERA DE ENFRIAMIENTO-POSTENFRIADOR	21488	MANGUERA INFERIOR-	CHARTER 3"
MANGUERA DE PASO-POSTENFRIADOR	21488	MANGUERA SUPERIOR-	26510
MANGUERA SILICÓN-CON POSTENFRIADOR	SIH250363C	MANGUERA SUPERIOR-	CHARTER 2 1/2"
MANGUERA SILICÓN-CON POSTENFRIADOR	SIH300363C	MANGUERA SUPERIOR-	CHARTER 2"
BANDA-BA	K040430	MANGUERA SUPERIOR FLEXIBLE-	2T170
BANDA-BA	K040445	1991	
BANDA-BA	K060435	BANDA-VENT	2/TR28429PB
BANDA-ALT-C/ALT 90A	2/9451PB	BANDA-VENT	2/TR28437PB
BANDA-ALT-C/ALT 90A	9451	BANDA-VENT	2/TR28473PB
BANDA-ALT 90A	2/9451PB	BANDA-VENT	2/TR28480PB
BANDA-ALT 90A	PQ17450	BANDA-VENT	2/TR28492PB



MASTER SERVICIO PESADO 2014

FREIGHTLINER

FLD

BANDA-VENT	TR28429	MANGUERA SUPERIOR-MOTOR A TUBO	CHARTER 2 1/2"
BANDA-VENT	TR28437	BANDA-ALT-BA-VENT	K080785
BANDA-VENT	TR28445	MANGUERA INFERIOR-	CHARTER 2 1/2"
BANDA-VENT	TR28473	1999	
BANDA-VENT	TR28480	BANDA-VENT	K080530
BANDA-VENT	TR28492	BANDA-VENT	K080610
MANGUERA SILICÓN-SIN POSTENFRIADOR	SIH200363C	MANGUERA SUPERIOR-TUBO A RAD.	CHARTER 2 1/4"
MANGUERA SILICÓN-SIN POSTENFRIADOR	SIH250363C	BANDA-TOMA DE FUERZA-ALT	K050345
MANGUERA SILICÓN-CON POSTENFRIADOR	SIH250363C	BANDA-TOMA DE FUERZA-AA	K060559
MANGUERA SILICÓN-CON POSTENFRIADOR	SIH300363C	MANGUERA SUPERIOR-MOTOR A TUBO	CHARTER 2 1/4"
BANDA-BA	K040430	BANDA-AA	K060523
BANDA-BA	K040445	MANGUERA DE PASO-	CHARTER 1 3/4"
BANDA-BA	K060435	MANGUERA INFERIOR-	CHARTER 2 1/4"
BANDA-ALT-C/ALT 90A	2/9451PB	1998	
BANDA-ALT-C/ALT 90A	9451	BANDA-VENT	K080570
BANDA-ALT	2/9463PB	MANGUERA SUPERIOR-TUBO A RAD.	CHARTER 2 1/2"
BANDA-ALT	2/TR28501PB	MANGUERA SUPERIOR-MOTOR A TUBO	CHARTER 2 1/4"
BANDA-ALT	9463	BANDA-ALT	K050345
BANDA-ALT	TR28501	BANDA-AA	PQ17550
BANDA-AA	9405	MANGUERA DE PASO-	CHARTER 1 3/4"
BANDA-AA	9412	MANGUERA INFERIOR-	CHARTER 2 1/2"
BANDA-AA	9420	1997	
BANDA-AA	9425	BANDA-VENT	K080496
BANDA-AA	9430	MANGUERA SILICÓN-TUBO A RAD.	SIH250363C
BANDA-AA	9435	MANGUERA SUPERIOR-TUBO A RAD.	CHARTER 2 1/2"
BANDA-AA	9447	MANGUERA SUPERIOR-MOTOR A TUBO	24436
BANDA-AA	9451	MANGUERA SUPERIOR-MOTOR A TUBO	CHARTER 2 1/4"
BANDA-AA	9540	BANDA-ALT	K050345
TERMOSTATO-190°	33579	BANDA-AA	PQ17550
TERMOSTATO-180°	33576	TERMOSTATO-190°	33579
TERMOSTATO-180°	33578	TERMOSTATO-180°	33576
TERMOSTATO-180°	33961	TERMOSTATO-180°	33578
TERMOSTATO-180°	33962	TERMOSTATO-170°	33577
TERMOSTATO-170°	33577	BANDA-	9545
MANGUERA DE AGUA-	30T 3/4"	MANGUERA DE PASO-	CHARTER 1 3/4"
MANGUERA DE PASO-	CHARTER 1 1/2"	MANGUERA INFERIOR-	CHARTER 2 1/2"
MANGUERA POSTENFRIADOR-	21488	MANGUERA SILICÓN-	SIH250363C
MANGUERA SUPERIOR FLEXIBLE-	2T170	1996	
CUMMINS M11 DIESEL		BANDA-VENT	K080570
2000		MANGUERA SILICÓN-TUBO A RAD.	SIH250363C
MANGUERA SUPERIOR-TUBO A RAD.	CHARTER 2 1/2"	MANGUERA SUPERIOR-TUBO A RAD.	CHARTER 2 1/2"
BANDA-TOMA DE FUERZA-AA	K060559	MANGUERA SUPERIOR-MOTOR A TUBO	24436
		MANGUERA SUPERIOR-MOTOR A TUBO	CHARTER 2 1/4"



MASTER SERVICIO PESADO 2014

FREIGHTLINER

FLD

BANDA-ALT	K050345	TERMOSTATO-190°	33579
TERMOSTATO-190°	33579	TERMOSTATO-180°	33576
TERMOSTATO-180°	33576	TERMOSTATO-180°	33578
TERMOSTATO-180°	33578	TERMOSTATO-175°	33960
TERMOSTATO-170°	33577	TERMOSTATO-170°	33577
MANGUERA DE PASO-	CHARTER 1 3/4"	1995	
MANGUERA INFERIOR-	CHARTER 2 1/2"	TERMOSTATO-190°	33579
MANGUERA SILICÓN-	SIH250363C	TERMOSTATO-180°	33576
1995		TERMOSTATO-180°	33578
BANDA-VENT	K080570	TERMOSTATO-175°	33960
MANGUERA SILICÓN-TUBO A RAD.	SIH250363C	TERMOSTATO-170°	33577
MANGUERA SUPERIOR-TUBO A RAD.	CHARTER 2 1/2"	1994	
MANGUERA SUPERIOR-MOTOR A TUBO	24436	TERMOSTATO-190°	33579
MANGUERA SUPERIOR-MOTOR A TUBO	CHARTER 2 1/4"	TERMOSTATO-180°	33576
BANDA-ALT	K050345	TERMOSTATO-180°	33578
BANDA-AA	PQ17550	TERMOSTATO-175°	33960
TERMOSTATO-190°	33579	TERMOSTATO-170°	33577
TERMOSTATO-180°	33576	1993	
TERMOSTATO-180°	33578	MANGUERA INFERIOR-VIBRAFLEX GS	23572
TERMOSTATO-170°	33577	BANDA-VENT	K080485
BANDA-	9545	BANDA-VENT	K080570
MANGUERA DE PASO-	CHARTER 1 3/4"	BANDA-VENT	K080585
MANGUERA INFERIOR-	CHARTER 2 1/2"	BANDA-VENT	K080690
MANGUERA SILICÓN-	SIH250363C	MANGUERA SILICÓN-TUBO A TUBO	SIH250363C
1994		MANGUERA INFERIOR-TUBO A RAD.	23572
TERMOSTATO-190°	33579	MANGUERA SILICÓN-TUBO A RAD.	SIH250363C
TERMOSTATO-180°	33576	MANGUERA SUPERIOR-TUBO A RAD.	CHARTER 2 1/2"
TERMOSTATO-180°	33578	MANGUERA SUPERIOR-TUBO A RAD.	CHARTER 2 1/4"
TERMOSTATO-170°	33577	MANGUERA SILICÓN-MOTOR A TUBO	SIH250363C
CUMMINS L10 DIESEL		MANGUERA SUPERIOR-MOTOR A TUBO	24436
1998		BANDA-ALT S/TURBO	K050340
TERMOSTATO-190°	33579	BANDA-ALT C/TURBO	K050350
TERMOSTATO-180°	33576	BANDA-ALT	K050350
TERMOSTATO-180°	33578	BANDA-AA S/TURBO	8573 GS
TERMOSTATO-175°	33960	BANDA-AA S/TURBO	PQ17530
TERMOSTATO-170°	33577	BANDA-AA C/TURBO	PQ17530
1997		BANDA-AA C/TURBO	PQ17550
TERMOSTATO-190°	33579	BANDA-AA C/TURBO	TR22508
TERMOSTATO-180°	33576	BANDA-AA	PQ17510
TERMOSTATO-180°	33578	TERMOSTATO-190°	33579
TERMOSTATO-175°	33960	TERMOSTATO-180°	33576
TERMOSTATO-170°	33577	TERMOSTATO-180°	33578
1996		TERMOSTATO-175°	33960



MASTER SERVICIO PESADO 2014

FREIGHTLINER

FLD

TERMOSTATO-170°	33577	1991	
BANDA-	9510	MANGUERA INFERIOR-VIBRAFLEX GS	23572
BANDA-	9530	BANDA-VENT	K080485
BANDA-	9545	BANDA-VENT	K080570
MANGUERA DE AGUA-	30T 3/4"	BANDA-VENT	K080585
MANGUERA DE CALEFACCIÓN-	CHARTER 3/4"	BANDA-VENT	K080690
MANGUERA DE PASO-	CHARTER 1 1/2"	MANGUERA SILICÓN-TUBO A TUBO	SIH250363C
MANGUERA INFERIOR-	CHARTER 2 1/2"	MANGUERA INFERIOR-TUBO A RAD.	23572
1992		MANGUERA SILICÓN-TUBO A RAD.	SIH250363C
MANGUERA INFERIOR-VIBRAFLEX GS	23572	MANGUERA SUPERIOR-TUBO A RAD.	CHARTER 2 1/2"
BANDA-VENT	K080485	MANGUERA SUPERIOR-TUBO A RAD.	CHARTER 2 1/4"
BANDA-VENT	K080570	MANGUERA SILICÓN-MOTOR A TUBO	SIH250363C
BANDA-VENT	K080585	MANGUERA SUPERIOR-MOTOR A TUBO	24436
BANDA-VENT	K080690	BANDA-ALT S/TURBO	K050340
MANGUERA SILICÓN-TUBO A TUBO	SIH250363C	BANDA-ALT C/TURBO	K050350
MANGUERA INFERIOR-TUBO A RAD.	23572	BANDA-ALT	K050350
MANGUERA SILICÓN-TUBO A RAD.	SIH250363C	BANDA-AA S/TURBO	8573 GS
MANGUERA SUPERIOR-TUBO A RAD.	CHARTER 2 1/2"	BANDA-AA S/TURBO	PQ17530
MANGUERA SUPERIOR-TUBO A RAD.	CHARTER 2 1/4"	BANDA-AA C/TURBO	PQ17530
MANGUERA SILICÓN-MOTOR A TUBO	SIH250363C	BANDA-AA C/TURBO	PQ17550
MANGUERA SUPERIOR-MOTOR A TUBO	24436	BANDA-AA C/TURBO	TR22508
BANDA-ALT S/TURBO	K050340	BANDA-AA	9510
BANDA-ALT C/TURBO	K050350	BANDA-AA	9530
BANDA-ALT	K050350	BANDA-AA	9545
BANDA-AA S/TURBO	8573 GS	BANDA-AA	PQ17510
BANDA-AA S/TURBO	PQ17530	TERMOSTATO-190°	33579
BANDA-AA C/TURBO	PQ17530	TERMOSTATO-180°	33576
BANDA-AA C/TURBO	PQ17550	TERMOSTATO-180°	33578
BANDA-AA C/TURBO	TR22508	TERMOSTATO-175°	33906
BANDA-AA	9510	TERMOSTATO-175°	33960
BANDA-AA	9530	TERMOSTATO-170°	33577
BANDA-AA	9545	MANGUERA DE AGUA-	30T 3/4"
BANDA-AA	PQ17510	MANGUERA DE CALEFACCIÓN-	CHARTER 3/4"
TERMOSTATO-190°	33579	MANGUERA DE PASO-	CHARTER 1 1/2"
TERMOSTATO-180°	33576	MANGUERA INFERIOR-	CHARTER 2 1/2"
TERMOSTATO-180°	33578	1990	
TERMOSTATO-175°	33960	MANGUERA INFERIOR-VIBRAFLEX GS	23572
TERMOSTATO-170°	33577	BANDA-VENT	K080485
MANGUERA DE AGUA-	30T 3/4"	BANDA-VENT	K080570
MANGUERA DE CALEFACCIÓN-	CHARTER 3/4"	BANDA-VENT	K080585
MANGUERA DE PASO-	CHARTER 1 1/2"	BANDA-VENT	K080690
MANGUERA INFERIOR-	CHARTER 2 1/2"	MANGUERA SUPERIOR-TUBO A RAD.	CHARTER 2 1/2"



MANGUERA SUPERIOR-TUBO A RAD.	CHARTER 2 1/4"	MANGUERA INFERIOR-TUBO A RAD.	CHARTER 2 1/2"
BANDA-ALT S/TURBO	K050340	MANGUERA SILICÓN-TUBO A RAD.	SIH250363C
BANDA-ALT C/TURBO	K050350	BANDA-TOMA DE FUERZA-ALT-AA	K060685
BANDA-AA S/TURBO	8573 GS	POLEA DEL TENSOR-TOMA DE FUERZA-ALT-AA	36095
BANDA-AA S/TURBO	PQ17530	TENSOR-TOMA DE FUERZA-ALT-AA	38532
BANDA-AA C/TURBO	PQ17530	MANGUERA INFERIOR-MOTOR A TUBO	21891
BANDA-AA C/TURBO	PQ17550	MANGUERA SILICÓN-MOTOR A TUBO	SIH250363C
BANDA-AA C/TURBO	TR22508	1999	
BANDA-AA	PQ17510	BANDA-VENT	K100710
MANGUERA DE CALEFACCIÓN-	CHARTER 3/4"	POLEA DEL TENSOR-VENT	36092
MANGUERA DE PASO-	CHARTER 1 1/2"	TENSOR-VENT	38535
MANGUERA INFERIOR-	CHARTER 2 1/2"	MANGUERA INFERIOR-TUBO A RAD.	CHARTER 2 1/2"
CUMMINS ISX DIESEL		MANGUERA SILICÓN-TUBO A RAD.	SIH250363C
2003		BANDA-TOMA DE FUERZA-ALT-AA	K060685
POLEA DEL TENSOR-VENT	36092	POLEA DEL TENSOR-TOMA DE FUERZA-ALT-AA	36095
TENSOR-VENT	38535	TENSOR-TOMA DE FUERZA-ALT-AA	38532
POLEA DEL TENSOR-TOMA DE FUERZA-ALT-AA	36095	MANGUERA INFERIOR-MOTOR A TUBO	21891
TENSOR-TOMA DE FUERZA-ALT-AA	38532	MANGUERA SILICÓN-MOTOR A TUBO	SIH250363C
BANDA-BA-VENT	K060685	CUMMINS ISM DIESEL	
BANDA-ALT-BA-AA	K100710	2003	
2002		MANGUERA INFERIOR-TUBO A RAD.	CHARTER 2 1/2"
POLEA DEL TENSOR-VENT	36092	MANGUERA SUPERIOR-TUBO A RAD.	CHARTER 2 1/2"
TENSOR-VENT	38535	MANGUERA INFERIOR-TUBO A ENFRIADOR	21042
POLEA DEL TENSOR-TOMA DE FUERZA-ALT-AA	36095	BANDA-TOMA DE FUERZA-ALT-VENT	K080817
TENSOR-TOMA DE FUERZA-ALT-AA	38532	TENSOR-TOMA DE FUERZA-ALT-VENT	38521
BANDA-BA-VENT	K060685	BANDA-TOMA DE FUERZA-AA	K060559
BANDA-ALT-BA-AA	K100710	TENSOR-TOMA DE FUERZA-AA	38505
2001		MANGUERA SUPERIOR-MOTOR A TUBO	24436
BANDA-VENT	K100710	MANGUERA INFERIOR-MOTOR A ENFRIADOR	CHARTER 2 1/2"
POLEA DEL TENSOR-VENT	36092	MANGUERA INFERIOR-ENFRIADOR A TUBO	CHARTER 3"
TENSOR-VENT	38535	POLEA DEL TENSOR-	36091
MANGUERA INFERIOR-TUBO A RAD.	CHARTER 2 1/2"	2002	
MANGUERA SILICÓN-TUBO A RAD.	SIH250363C	MANGUERA INFERIOR-TUBO A RAD.	CHARTER 2 1/2"
BANDA-TOMA DE FUERZA-ALT-AA	K060685	MANGUERA SUPERIOR-TUBO A RAD.	CHARTER 2 1/2"
POLEA DEL TENSOR-TOMA DE FUERZA-ALT-AA	36095	MANGUERA INFERIOR-TUBO A ENFRIADOR	21042
TENSOR-TOMA DE FUERZA-ALT-AA	38532	BANDA-TOMA DE FUERZA-ALT-VENT	K080817
MANGUERA INFERIOR-MOTOR A TUBO	21891	TENSOR-TOMA DE FUERZA-ALT-VENT	38521
MANGUERA SILICÓN-MOTOR A TUBO	SIH250363C	BANDA-TOMA DE FUERZA-AA	K060559
POLEA DEL TENSOR-	36091	TENSOR-TOMA DE FUERZA-AA	38505
2000		MANGUERA SUPERIOR-MOTOR A TUBO	CHARTER 2 1/2"
BANDA-VENT	K100710	MANGUERA INFERIOR-MOTOR A ENFRIADOR	CHARTER 2 1/2"
POLEA DEL TENSOR-VENT	36092	MANGUERA INFERIOR-ENFRIADOR A TUBO	CHARTER 3"
TENSOR-VENT	38535	POLEA DEL TENSOR-	36091



2001		TERMOSTATO-180°-C/DOBLE TERMOSTATO	33966
MANGUERA SILICÓN-TUBO A RAD.	SIH250363C	TERMOSTATO-180°	33959
MANGUERA SILICÓN-TUBO A ENFRIADOR	SIH250363C	2000	
BANDA-TOMA DE FUERZA-AA	K060559	TERMOSTATO-180°-C/DOBLE TERMOSTATO	33966
TENSOR-TOMA DE FUERZA-AA	38505	TERMOSTATO-180°	33959
MANGUERA SILICÓN-MOTOR A TUBO	SIH250363C	1999	
MANGUERA SILICÓN-MOTOR A ENFRIADOR	SIH250363C	TERMOSTATO-180°-C/DOBLE TERMOSTATO	33966
BANDA-ALT-VENT	K080816	TERMOSTATO-180°	33959
TENSOR-ALT-VENT	38521	1998	
		TERMOSTATO-180°-C/DOBLE TERMOSTATO	33966
2000		TERMOSTATO-180°	33959
MANGUERA SILICÓN-TUBO A RAD.	SIH250363C	CUMMINS ISB DIESEL	
BANDA-TOMA DE FUERZA-AA	K060559	2000	
TENSOR-TOMA DE FUERZA-AA	38505	TERMOSTATO-190°	33915
MANGUERA SILICÓN-MOTOR A TUBO	SIH250363C	TERMOSTATO-180°	33956
BANDA-ALT-BA-VENT	K080785	CUMMINS C Series 8.3 L DIESEL	
TENSOR-ALT-BA-VENT	38521	1996	
POLEA DEL TENSOR-	36091	TERMOSTATO-180°-C/DOBLE TERMOSTATO	33966
1999		TERMOSTATO-180°	33959
BANDA-VENT	K080530	1995	
BANDA-VENT	K080610	TERMOSTATO-180°-C/DOBLE TERMOSTATO	33966
MANGUERA INFERIOR-TUBO A RAD.	24436	TERMOSTATO-180°	33959
MANGUERA SUPERIOR-TUBO A RAD.	24436	1991	
BANDA-TOMA DE FUERZA-ALT	K050345	TERMOSTATO-180°-C/DOBLE TERMOSTATO	33966
BANDA-TOMA DE FUERZA-AA	K060559	TERMOSTATO-180°	33959
TENSOR-TOMA DE FUERZA-AA	38505	CATERPILLAR C16 DIESEL	
MANGUERA INFERIOR-MOTOR A TUBO	24436	2004	
MANGUERA SUPERIOR-MOTOR A TUBO	24436	BANDA-VENT-AA	K060547
BANDA-AA	K060523	POLEA DEL TENSOR-VENT-AA	36091
MANGUERA DE PASO-	CHARTER 1 3/4"	TENSOR-VENT-AA	38508
POLEA DEL TENSOR-	36091	MANGUERA SILICÓN-TUBO A RAD.	SIH250363C
1998		MANGUERA SILICÓN-MOTOR A TUBO	SIH250363C
BANDA-VENT	K080570	MANGUERA SILICÓN-MOTOR A TUBO	SIH300363C
MANGUERA SILICÓN-TUBO A RAD.	SIH250363C	BANDA-ALT-VENT	K080944
MANGUERA SUPERIOR-MOTOR A TUBO	24436	POLEA-ALT-VENT	36091
BANDA-ALT	K050345	TENSOR-ALT-VENT	38506
BANDA-	9545	TERMOSTATO-190°	33579
MANGUERA DE PASO-	CHARTER 1 3/4"	TERMOSTATO-180°	33576
MANGUERA SILICÓN-	SIH250363C	TERMOSTATO-180°	33578
CUMMINS ISC DIESEL		TERMOSTATO-170°	33577
2002		2003	
TERMOSTATO-180°-C/DOBLE TERMOSTATO	33966	BANDA-VENT-AA	K060547
TERMOSTATO-180°	33959	POLEA DEL TENSOR-VENT-AA	36091
2001		TENSOR-VENT-AA	38508



MASTER SERVICIO PESADO 2014

FREIGHTLINER

FLD

MANGUERA SILICÓN-TUBO A RAD.	SIH250363C	TENSOR-VENT-AA	38508
MANGUERA SILICÓN-MOTOR A TUBO	SIH250363C	MANGUERA SILICÓN-TUBO A RAD.	SIH250363C
MANGUERA SILICÓN-MOTOR A TUBO	SIH300363C	MANGUERA SILICÓN-TUBO A RAD.	SIH300363C
BANDA-ALT-VENT	K080944	MANGUERA SILICÓN-MOTOR A TUBO	SIH250363C
POLEA-ALT-VENT	36091	MANGUERA SILICÓN-MOTOR A TUBO	SIH300363C
TENSOR-ALT-VENT	38506	BANDA-ALT-VENT	K080952
TERMOSTATO-190°	33579	POLEA-ALT-VENT	36091
TERMOSTATO-180°	33576	TENSOR-ALT-VENT	38506
TERMOSTATO-180°	33578	TERMOSTATO-190°	33579
TERMOSTATO-170°	33577	TERMOSTATO-180°	33576
2002		TERMOSTATO-180°	33578
BANDA-VENT-AA	K060598	TERMOSTATO-170°	33577
POLEA DEL TENSOR-VENT-AA	36091	CATERPILLAR C15 DIESEL	
TENSOR-VENT-AA	38508	2010	
MANGUERA INFERIOR-TUBO A RAD.	CHARTER 3"	BANDA-VENT	K120985
MANGUERA SUPERIOR-TUBO A RAD.	CHARTER 2 1/2"	TENSOR-VENT	38636
MANGUERA INFERIOR-MOTOR A TUBO	CHARTER 3"	POLEA-AA INFERIOR	36282
MANGUERA SUPERIOR-MOTOR A TUBO	CHARTER 2 1/2"	BANDA-AA	K060723
BANDA-ALT-VENT	K080952	TENSOR-AA	38609
POLEA-ALT-VENT	36091	TERMOSTATO-190°	33579
TENSOR-ALT-VENT	38506	TERMOSTATO-180°	33576
TERMOSTATO-190°	33579	TERMOSTATO-180°	33578
TERMOSTATO-180°	33576	TERMOSTATO-170°	33577
TERMOSTATO-180°	33578	BOMBA DE AGUA-	44062HD
TERMOSTATO-170°	33577	2009	
2001		BANDA-VENT	K120985
BANDA-VENT-AA	K060598	TENSOR-VENT	38636
POLEA DEL TENSOR-VENT-AA	36091	POLEA-AA INFERIOR	36282
TENSOR-VENT-AA	38508	BANDA-AA	K060723
MANGUERA SILICÓN-TUBO A RAD.	SIH250363C	TENSOR-AA	38609
MANGUERA SILICÓN-TUBO A RAD.	SIH300363C	TERMOSTATO-190°	33579
MANGUERA SILICÓN-MOTOR A TUBO	SIH250363C	TERMOSTATO-180°	33576
MANGUERA SILICÓN-MOTOR A TUBO	SIH300363C	TERMOSTATO-180°	33578
BANDA-ALT-VENT	K080952	TERMOSTATO-170°	33577
POLEA-ALT-VENT	36091	BOMBA DE AGUA-	44062HD
TENSOR-ALT-VENT	38506	2008	
TERMOSTATO-190°	33579	BANDA-VENT-AA	K060586
TERMOSTATO-180°	33576	TENSOR-VENT-AA	38511
TERMOSTATO-180°	33578	MANGUERA INFERIOR-MOTOR A RAD.	23015
TERMOSTATO-170°	33577	MANGUERA SUPERIOR-MOTOR A RAD.	23229
2000		POLEA-MOTOR	36091
BANDA-VENT-AA	K060598	POLEA-MOTOR	36341
POLEA DEL TENSOR-VENT-AA	36091	BANDA-ALT-VENT	K080991



MASTER SERVICIO PESADO 2014

FREIGHTLINER

FLD

TENSOR-ALT-VENT	38569	MANGUERA SILICÓN-MOTOR A TUBO	SIH250363C
TERMOSTATO-190°	33579	MANGUERA SILICÓN-MOTOR A RAD.	SIH250363C
TERMOSTATO-180°	33576	POLEA-MOTOR	36091
TERMOSTATO-180°	33578	POLEA-MOTOR	36093
TERMOSTATO-170°	33577	BANDA-ALT-VENT	K080926
BOMBA DE AGUA-	44062HD	TENSOR-ALT-VENT	38569
POLEA DEL TENSOR-	36091	TERMOSTATO-190°	33579
2007		TERMOSTATO-180°	33576
BANDA-VENT-AA	K060586	TERMOSTATO-180°	33578
POLEA DEL TENSOR-VENT-AA	36091	TERMOSTATO-170°	33577
TENSOR-VENT-AA	38511	2004	
MANGUERA INFERIOR-MOTOR A RAD.	23015	BANDA-VENT-AA	K060547
MANGUERA SUPERIOR-MOTOR A RAD.	23229	POLEA DEL TENSOR-VENT-AA	36091
POLEA-MOTOR	36091	TENSOR-VENT-AA	38508
POLEA-MOTOR	36093	MANGUERA SILICÓN-TUBO A RAD.	SIH250363C
BANDA-ALT-VENT	K080991	MANGUERA SILICÓN-MOTOR A TUBO	SIH250363C
TENSOR-ALT-VENT	38569	MANGUERA SILICÓN-MOTOR A TUBO	SIH300363C
TERMOSTATO-190°	33579	POLEA-MOTOR	36091
TERMOSTATO-180°	33576	POLEA-MOTOR	36093
TERMOSTATO-180°	33578	BANDA-ALT-VENT	K080944
TERMOSTATO-170°	33577	POLEA-ALT-VENT	36091
2006		TENSOR-ALT-VENT	38506
BANDA-VENT-AA	K060635	TERMOSTATO-190°	33579
POLEA DEL TENSOR-VENT-AA	36091	TERMOSTATO-180°	33576
TENSOR-VENT-AA	38511	TERMOSTATO-180°	33578
MANGUERA SILICÓN-RAD. A TUBO	SIH250363C	TERMOSTATO-170°	33577
MANGUERA SUPERIOR-RAD. A TUBO	21891	2003	
MANGUERA SILICÓN-MOTOR A TUBO	SIH250363C	BANDA-VENT-AA	K060547
MANGUERA SILICÓN-MOTOR A RAD.	SIH250363C	POLEA DEL TENSOR-VENT-AA	36091
POLEA-MOTOR	36091	TENSOR-VENT-AA	38508
POLEA-MOTOR	36093	MANGUERA SILICÓN-TUBO A RAD.	SIH250363C
BANDA-ALT-VENT	K080926	MANGUERA SILICÓN-MOTOR A TUBO	SIH250363C
TENSOR-ALT-VENT	38569	MANGUERA SILICÓN-MOTOR A TUBO	SIH300363C
TERMOSTATO-190°	33579	BANDA-ALT-VENT	K080944
TERMOSTATO-180°	33576	POLEA-ALT-VENT	36091
TERMOSTATO-180°	33578	TENSOR-ALT-VENT	38506
TERMOSTATO-170°	33577	TERMOSTATO-190°	33579
2005		TERMOSTATO-180°	33576
BANDA-VENT-AA	K060635	TERMOSTATO-180°	33578
POLEA DEL TENSOR-VENT-AA	36091	TERMOSTATO-170°	33577
TENSOR-VENT-AA	38511	2002	
MANGUERA SILICÓN-RAD. A TUBO	SIH250363C	BANDA-VENT-AA	K060598
MANGUERA SUPERIOR-RAD. A TUBO	21891	POLEA DEL TENSOR-VENT-AA	36091



MASTER SERVICIO PESADO 2014

FREIGHTLINER

FLD

TENSOR-VENT-AA	38508	2007	
MANGUERA INFERIOR-TUBO A RAD.	CHARTER 3"	MANGUERA INFERIOR-RAD. A TUBO	21135
MANGUERA SUPERIOR-TUBO A RAD.	CHARTER 2 1/2"	MANGUERA SILICÓN-RAD. A TUBO	SIH250363C
MANGUERA INFERIOR-MOTOR A TUBO	CHARTER 3"	MANGUERA SILICÓN-MOTOR A TUBO	SIH250363C
MANGUERA SUPERIOR-MOTOR A TUBO	CHARTER 2 1/2"	POLEA-MOTOR	36093
BANDA-ALT-VENT	K080952	BANDA-ALT-VENT-AA	K081005
POLEA-ALT-VENT	36091	TENSOR-ALT-VENT-AA	38590
TENSOR-ALT-VENT	38506	TERMOSTATO-190°	33579
TERMOSTATO-190°	33579	TERMOSTATO-180°	33576
TERMOSTATO-180°	33576	TERMOSTATO-180°	33578
TERMOSTATO-180°	33578	TERMOSTATO-170°	33577
TERMOSTATO-170°	33577	2006	
2001		MANGUERA INFERIOR-RAD. A TUBO	21135
BANDA-VENT-AA	K060598	MANGUERA SILICÓN-RAD. A TUBO	SIH250363C
POLEA DEL TENSOR-VENT-AA	36091	MANGUERA SILICÓN-MOTOR A TUBO	SIH250363C
TENSOR-VENT-AA	38508	POLEA-MOTOR	36093
MANGUERA SILICÓN-TUBO A RAD.	SIH250363C	BANDA-ALT-VENT-AA	K081005
MANGUERA SILICÓN-TUBO A RAD.	SIH300363C	TENSOR-ALT-VENT-AA	38590
MANGUERA SILICÓN-MOTOR A TUBO	SIH250363C	TERMOSTATO-190°	33579
MANGUERA SILICÓN-MOTOR A TUBO	SIH300363C	TERMOSTATO-180°	33576
BANDA-ALT-VENT	K080952	TERMOSTATO-180°	33578
POLEA-ALT-VENT	36091	TERMOSTATO-170°	33577
TENSOR-ALT-VENT	38506	2005	
TERMOSTATO-190°	33579	MANGUERA INFERIOR-RAD. A TUBO	21135
TERMOSTATO-180°	33576	MANGUERA SILICÓN-RAD. A TUBO	SIH250363C
TERMOSTATO-180°	33578	MANGUERA SILICÓN-MOTOR A TUBO	SIH250363C
TERMOSTATO-170°	33577	POLEA-MOTOR	36093
2000		BANDA-ALT-VENT-AA	K081005
BANDA-VENT-AA	K060598	TENSOR-ALT-VENT-AA	38590
POLEA DEL TENSOR-VENT-AA	36091	TERMOSTATO-190°	33579
TENSOR-VENT-AA	38508	TERMOSTATO-180°	33576
MANGUERA SILICÓN-TUBO A RAD.	SIH250363C	TERMOSTATO-180°	33578
MANGUERA SILICÓN-TUBO A RAD.	SIH300363C	TERMOSTATO-170°	33577
MANGUERA SILICÓN-MOTOR A TUBO	SIH250363C	2004	
MANGUERA SILICÓN-MOTOR A TUBO	SIH300363C	POLEA-MOTOR	36093
BANDA-ALT-VENT	K080952	TERMOSTATO-190°	33579
POLEA-ALT-VENT	36091	TERMOSTATO-180°	33576
TENSOR-ALT-VENT	38506	TERMOSTATO-180°	33578
TERMOSTATO-190°	33579	TERMOSTATO-170°	33577
TERMOSTATO-180°	33576	CATERPILLAR C12 DIESEL	
TERMOSTATO-180°	33578	2004	
TERMOSTATO-170°	33577	BANDA-VENT-AA	K060523
CATERPILLAR C13 DIESEL		POLEA DEL TENSOR-VENT-AA	36091



MASTER SERVICIO PESADO 2014

FREIGHTLINER

FLD

TENSOR-VENT-AA	38524	TERMOSTATO-170°	33577
MANGUERA INFERIOR-RAD. A TUBO	21891	2001	
MANGUERA SUPERIOR-RAD. A TUBO	21891	BANDA-VENT-AA	9500
MANGUERA SILICÓN-MOTOR A TUBO	SIH250363C	BANDA-VENT-AA	K060523
POLEA-ALT-VENT	36091	POLEA DEL TENSOR-VENT-AA	36091
TENSOR-ALT-VENT	38506	TENSOR-VENT-AA	38524
TERMOSTATO-190°	33579	MANGUERA SILICÓN-TUBO A RAD.	SIH250363C
TERMOSTATO-180°	33576	MANGUERA SILICÓN-TUBO A ENFRIADOR	SIH250363C
TERMOSTATO-180°	33578	MANGUERA SUPERIOR-MOTOR A TUBO	21891
TERMOSTATO-170°	33577	MANGUERA INFERIOR-MOTOR A REFRIGERADOR	21891
2003		BANDA-ALT-VENT	K080780
BANDA-VENT-AA	K060480	BANDA-ALT-VENT	K080855
POLEA DEL TENSOR-VENT-AA	36091	POLEA-ALT-VENT	36091
TENSOR-VENT-AA	38524	TENSOR-ALT-VENT	38506
MANGUERA INFERIOR-TUBO A RAD.	CHARTER 2 1/2"	TERMOSTATO-190°	33579
MANGUERA SUPERIOR-TUBO A RAD.	CHARTER 2 1/2"	TERMOSTATO-180°	33576
MANGUERA INFERIOR-TUBO A ENFRIADOR	CHARTER 2 1/2"	TERMOSTATO-180°	33578
MANGUERA SUPERIOR-MOTOR A TUBO	21891	TERMOSTATO-170°	33577
MANGUERA INFERIOR-MOTOR A ENFRIADOR	21891	2000	
BANDA-ALT-VENT	K080922	BANDA-VENT-AA	K060523
POLEA-ALT-VENT	36091	TENSOR-VENT-AA	38534
TENSOR-ALT-VENT	38506	BANDA-TOMA DE FUERZA-ALT-VENT	K080855
TERMOSTATO-190°	33579	POLEA DEL TENSOR-TOMA DE FUERZA-ALT-VENT	36091
TERMOSTATO-180°	33576	TENSOR-TOMA DE FUERZA-ALT-VENT	38506
TERMOSTATO-180°	33578	POLEA-ALT-VENT	36091
TERMOSTATO-170°	33577	POLEA DEL TENSOR-ALT-AA	38092
2002		TERMOSTATO-190°	33579
BANDA-VENT-AA	9500	TERMOSTATO-180°	33576
BANDA-VENT-AA	K060529	TERMOSTATO-180°	33578
POLEA DEL TENSOR-VENT-AA	36091	TERMOSTATO-170°	33577
TENSOR-VENT-AA	38524	1999	
MANGUERA INFERIOR-TUBO A RAD.	CHARTER 2 1/2"	TENSOR-VENT-AA	38534
MANGUERA SUPERIOR-TUBO A RAD.	CHARTER 2 1/2"	BANDA-ALT-VENT	K080922
MANGUERA INFERIOR-TUBO A ENFRIADOR	CHARTER 2 1/2"	POLEA-ALT-VENT	36091
MANGUERA SUPERIOR-MOTOR A TUBO	21891	TENSOR-ALT-VENT	38506
MANGUERA INFERIOR-MOTOR A ENFRIADOR	21891	POLEA DEL TENSOR-ALT-AA	38092
BANDA-ALT-VENT	K080780	BANDA-AA	K060480
POLEA-ALT-VENT	36091	BANDA-AA	K060523
TENSOR-ALT-VENT	38506	TERMOSTATO-190°	33579
TERMOSTATO-190°	33579	TERMOSTATO-180°	33576
TERMOSTATO-180°	33576	TERMOSTATO-180°	33578
TERMOSTATO-180°	33578	TERMOSTATO-170°	33577
		1998	



MASTER SERVICIO PESADO 2014

FREIGHTLINER

FLD

TENSOR-VENT-AA	38534	BANDA-ALT-VENT-AA	K081005
BANDA-ALT-VENT	K080922	TENSOR-ALT-VENT-AA	38590
POLEA-ALT-VENT	36091	TERMOSTATO-190°	33579
TENSOR-ALT-VENT	38506	TERMOSTATO-180°	33576
POLEA DEL TENSOR-ALT-AA	38092	TERMOSTATO-180°	33578
BANDA-AA	K060480	TERMOSTATO-170°	33577
BANDA-AA	K060523	2006	
TERMOSTATO-190°	33579	MANGUERA INFERIOR-RAD. A TUBO	21135
TERMOSTATO-180°	33576	MANGUERA SILICÓN-RAD. A TUBO	SIH250363C
TERMOSTATO-180°	33578	MANGUERA SILICÓN-MOTOR A TUBO	SIH250363C
TERMOSTATO-170°	33577	POLEA-MOTOR	36093
1997		BANDA-ALT-VENT-AA	K081005
BANDA-VENT-AA	9530	TENSOR-ALT-VENT-AA	38590
MANGUERA INFERIOR-TUBO A RAD.	CHARTER 3"	TERMOSTATO-190°	33579
MANGUERA SUPERIOR-TUBO A RAD.	21194	TERMOSTATO-180°	33576
MANGUERA INFERIOR-MOTOR A TUBO	21194	TERMOSTATO-180°	33578
MANGUERA SUPERIOR-MOTOR A TUBO	21940	TERMOSTATO-170°	33577
BANDA-ALT-VENT	K080680	2005	
POLEA-ALT-VENT	36091	MANGUERA INFERIOR-RAD. A TUBO	21135
TENSOR-ALT-VENT	38514	MANGUERA SILICÓN-RAD. A TUBO	SIH250363C
TERMOSTATO-190°	33579	MANGUERA SILICÓN-MOTOR A TUBO	SIH250363C
TERMOSTATO-180°	33576	POLEA-MOTOR	36093
TERMOSTATO-180°	33578	BANDA-ALT-VENT-AA	K081005
TERMOSTATO-170°	33577	TENSOR-ALT-VENT-AA	38590
1996		TERMOSTATO-190°	33579
BANDA-VENT-AA	9530	TERMOSTATO-180°	33576
MANGUERA INFERIOR-TUBO A RAD.	CHARTER 3"	TERMOSTATO-180°	33578
MANGUERA SUPERIOR-TUBO A RAD.	21194	TERMOSTATO-170°	33577
MANGUERA INFERIOR-MOTOR A TUBO	21194	2004	
MANGUERA SUPERIOR-MOTOR A TUBO	21940	POLEA-MOTOR	36093
BANDA-ALT-VENT	K080680	TERMOSTATO-190°	33579
POLEA-ALT-VENT	36091	TERMOSTATO-180°	33576
TENSOR-ALT-VENT	38514	TERMOSTATO-180°	33578
TERMOSTATO-190°	33579	TERMOSTATO-170°	33577
TERMOSTATO-180°	33576	CATERPILLAR C10 DIESEL	
TERMOSTATO-180°	33578	2004	
TERMOSTATO-170°	33577	BANDA-VENT-AA	K060523
CATERPILLAR C11 DIESEL		POLEA DEL TENSOR-VENT-AA	36091
2007		TENSOR-VENT-AA	38524
MANGUERA INFERIOR-RAD. A TUBO	21135	MANGUERA INFERIOR-RAD. A TUBO	21891
MANGUERA SILICÓN-RAD. A TUBO	SIH250363C	MANGUERA SUPERIOR-RAD. A TUBO	21891
MANGUERA SILICÓN-MOTOR A TUBO	SIH250363C	MANGUERA SILICÓN-MOTOR A TUBO	SIH250363C
POLEA-MOTOR	36093	POLEA-ALT-VENT	36091



MASTER SERVICIO PESADO 2014

FREIGHTLINER

FLD

TENSOR-ALT-VENT	38506	MANGUERA SILICÓN-TUBO A RAD.	SIH250363C
TERMOSTATO-190°	33579	MANGUERA SILICÓN-TUBO A ENFRIADOR	SIH250363C
TERMOSTATO-180°	33576	MANGUERA SUPERIOR-MOTOR A TUBO	21891
TERMOSTATO-180°	33578	MANGUERA INFERIOR-MOTOR A REGRIGERADOR	21891
TERMOSTATO-170°	33577	BANDA-ALT-VENT	K080780
2003		BANDA-ALT-VENT	K080855
BANDA-VENT-AA	K060480	POLEA-ALT-VENT	36091
POLEA DEL TENSOR-VENT-AA	36091	TENSOR-ALT-VENT	38506
TENSOR-VENT-AA	38524	TERMOSTATO-190°	33579
MANGUERA INFERIOR-TUBO A RAD.	CHARTER 2 1/2"	TERMOSTATO-180°	33576
MANGUERA SUPERIOR-TUBO A RAD.	CHARTER 2 1/2"	TERMOSTATO-180°	33578
MANGUERA INFERIOR-TUBO A ENFRIADOR	CHARTER 2 1/2"	TERMOSTATO-170°	33577
MANGUERA SUPERIOR-MOTOR A TUBO	21891	2000	
MANGUERA INFERIOR-MOTOR A ENFRIADOR	21891	BANDA-VENT-AA	K060523
BANDA-ALT-VENT	K080922	TENSOR-VENT-AA	38534
POLEA-ALT-VENT	36091	BANDA-TOMA DE FUERZA-ALT-VENT	K080855
TENSOR-ALT-VENT	38506	POLEA DEL TENSOR-TOMA DE FUERZA-ALT-VENT	36091
TERMOSTATO-190°	33579	TENSOR-TOMA DE FUERZA-ALT-VENT	38506
TERMOSTATO-180°	33576	POLEA-ALT-VENT	36091
TERMOSTATO-180°	33578	POLEA DEL TENSOR-ALT-AA	38092
TERMOSTATO-170°	33577	TERMOSTATO-190°	33579
2002		TERMOSTATO-180°	33576
BANDA-VENT-AA	9500	TERMOSTATO-180°	33578
BANDA-VENT-AA	K060529	TERMOSTATO-170°	33577
POLEA DEL TENSOR-VENT-AA	36091	1999	
TENSOR-VENT-AA	38524	TENSOR-VENT-AA	38534
MANGUERA INFERIOR-TUBO A RAD.	CHARTER 2 1/2"	BANDA-ALT-VENT	K080922
MANGUERA SUPERIOR-TUBO A RAD.	CHARTER 2 1/2"	POLEA-ALT-VENT	36091
MANGUERA INFERIOR-TUBO A ENFRIADOR	CHARTER 2 1/2"	TENSOR-ALT-VENT	38506
MANGUERA SUPERIOR-MOTOR A TUBO	21891	POLEA DEL TENSOR-ALT-AA	38092
MANGUERA INFERIOR-MOTOR A ENFRIADOR	21891	BANDA-AA	K060480
BANDA-ALT-VENT	K080780	BANDA-AA	K060523
POLEA-ALT-VENT	36091	TERMOSTATO-190°	33579
TENSOR-ALT-VENT	38506	TERMOSTATO-180°	33576
TERMOSTATO-190°	33579	TERMOSTATO-180°	33578
TERMOSTATO-180°	33576	TERMOSTATO-170°	33577
TERMOSTATO-180°	33578	1998	
TERMOSTATO-170°	33577	TENSOR-VENT-AA	38534
2001		BANDA-ALT-VENT	K080922
BANDA-VENT-AA	9500	POLEA-ALT-VENT	36091
BANDA-VENT-AA	K060523	TENSOR-ALT-VENT	38506
POLEA DEL TENSOR-VENT-AA	36091	POLEA DEL TENSOR-ALT-AA	38092
TENSOR-VENT-AA	38524	BANDA-AA	K060480



MASTER SERVICIO PESADO 2014

FREIGHTLINER

FLD

BANDA-AA	K060523	TERMOSTATO-170°	33577
TERMOSTATO-190°	33579	2000	
TERMOSTATO-180°	33576	BANDA-VENT-AA	K060598
TERMOSTATO-180°	33578	POLEA DEL TENSOR-VENT-AA	36091
TERMOSTATO-170°	33577	TENSOR-VENT-AA	38508
1997		MANGUERA SILICÓN-TUBO A RAD.	SIH250363C
BANDA-VENT-AA	9530	MANGUERA SILICÓN-TUBO A RAD.	SIH300363C
MANGUERA INFERIOR-TUBO A RAD.	CHARTER 3"	MANGUERA SILICÓN-MOTOR A TUBO	SIH250363C
MANGUERA SUPERIOR-TUBO A RAD.	21194	MANGUERA SILICÓN-MOTOR A TUBO	SIH300363C
MANGUERA INFERIOR-MOTOR A TUBO	21194	BANDA-ALT-VENT	K080952
MANGUERA SUPERIOR-MOTOR A TUBO	21940	POLEA-ALT-VENT	36091
BANDA-ALT-VENT	K080680	TENSOR-ALT-VENT	38506
POLEA-ALT-VENT	36091	TERMOSTATO-190°	33579
TENSOR-ALT-VENT	38514	TERMOSTATO-180°	33576
TERMOSTATO-190°	33579	TERMOSTATO-180°	33578
TERMOSTATO-180°	33576	TERMOSTATO-170°	33577
TERMOSTATO-180°	33578	1999	
TERMOSTATO-170°	33577	BANDA-VENT-AA	K060594
1996		POLEA DEL TENSOR-VENT-AA	36091
BANDA-AA	PQ17500	TENSOR-VENT-AA	38508
TERMOSTATO-175°	33549	MANGUERA SILICÓN-TUBO A RAD.	SIH250363C
CATERPILLAR 3406 E DIESEL		MANGUERA SILICÓN-TUBO A RAD.	SIH300363C
2000		MANGUERA SILICÓN-MOTOR A TUBO	SIH250363C
TENSOR-VENT-AA	38506	MANGUERA SILICÓN-MOTOR A TUBO	SIH300363C
TENSOR-ALT-VENT	38508	BANDA-ALT-VENT	K080952
1999		POLEA-ALT-VENT	36091
TENSOR-VENT-AA	38506	TENSOR-ALT-VENT	38506
TENSOR-ALT-VENT	38508	TERMOSTATO-190°	33579
CATERPILLAR 3406 DIESEL		TERMOSTATO-180°	33576
2007		TERMOSTATO-180°	33578
TERMOSTATO-190°	33579	TERMOSTATO-170°	33577
TERMOSTATO-180°	33576	1998	
TERMOSTATO-180°	33578	BANDA-VENT-AA	K060594
TERMOSTATO-170°	33577	POLEA DEL TENSOR-VENT-AA	36091
2002		TENSOR-VENT-AA	38508
TERMOSTATO-190°	33579	MANGUERA SILICÓN-TUBO A RAD.	SIH250363C
TERMOSTATO-180°	33576	MANGUERA SILICÓN-TUBO A RAD.	SIH300363C
TERMOSTATO-180°	33578	MANGUERA SILICÓN-MOTOR A TUBO	SIH250363C
TERMOSTATO-170°	33577	MANGUERA SILICÓN-MOTOR A TUBO	SIH300363C
2001		BANDA-ALT-VENT	K080952
TERMOSTATO-190°	33579	POLEA-ALT-VENT	36091
TERMOSTATO-180°	33576	TENSOR-ALT-VENT	38506
TERMOSTATO-180°	33578	TERMOSTATO-190°	33579



MASTER SERVICIO PESADO 2014

FREIGHTLINER

FLD

TERMOSTATO-180°	33576	MANGUERA SILICÓN-MOTOR A TUBO	SIH250363C
TERMOSTATO-180°	33578	MANGUERA SILICÓN-MOTOR A TUBO	SIH300363C
TERMOSTATO-170°	33577	BANDA-ALT-AA	9600
1997		BANDA-ALT-AA	9620
BANDA-VENT- OPCIONAL	TR22517	BANDA-ALT	2/9550PB
BANDA-VENT	2/TR22517PB	BANDA-ALT	9550
BANDA-VENT	TR22508	TERMOSTATO-190°	33579
BANDA-VENT	TR22534	TERMOSTATO-180°	33576
MANGUERA SILICÓN-TUBO A RAD.	SIH250363C	TERMOSTATO-180°	33578
MANGUERA SILICÓN-TUBO A RAD.	SIH300363C	TERMOSTATO-170°	33577
MANGUERA SILICÓN-MOTOR A TUBO	SIH250363C	1994	
MANGUERA SILICÓN-MOTOR A TUBO	SIH300363C	BANDA-VENT- OPCIONAL	TR22517
BANDA-ALT-AA	9600	BANDA-VENT	2/TR22517PB
BANDA-ALT-AA	9620	BANDA-ALT-AA	9625
BANDA-ALT	2/9550PB	BANDA-ALT	2/9550PB
BANDA-ALT	9550	BANDA-ALT	9550
TERMOSTATO-190°	33579	TERMOSTATO-190°	33579
TERMOSTATO-180°	33576	TERMOSTATO-180°	33576
TERMOSTATO-180°	33578	TERMOSTATO-180°	33578
TERMOSTATO-170°	33577	TERMOSTATO-170°	33577
1996		1993	
BANDA-VENT- OPCIONAL	TR22517	BANDA-VENT- OPCIONAL	TR22517
BANDA-VENT	2/TR22517PB	BANDA-VENT	2/TR22517PB
BANDA-VENT	TR22534	BANDA-VENT	TR22508
MANGUERA SILICÓN-TUBO A RAD.	SIH250363C	BANDA-VENT	TR22534
MANGUERA SILICÓN-TUBO A RAD.	SIH300363C	BANDA-ALT-AA	9600
MANGUERA SILICÓN-MOTOR A TUBO	SIH250363C	BANDA-ALT-AA	9620
MANGUERA SILICÓN-MOTOR A TUBO	SIH300363C	BANDA-ALT	2/9550PB
BANDA-ALT-VENT-AA	9620	BANDA-ALT	9550
BANDA-ALT-AA	9600	TERMOSTATO-190°	33579
BANDA-ALT	2/9550PB	TERMOSTATO-180°	33576
BANDA-ALT	9550	TERMOSTATO-180°	33578
TERMOSTATO-190°	33579	TERMOSTATO-170°	33577
TERMOSTATO-180°	33576	1992	
TERMOSTATO-180°	33578	BANDA-VENT	2/TR22517PB
TERMOSTATO-170°	33577	BANDA-VENT	TR22508
1995		BANDA-VENT	TR22517
BANDA-VENT- OPCIONAL	TR22517	BANDA-VENT	TR22534
BANDA-VENT	2/TR22517PB	BANDA-ALT-AA	9600
BANDA-VENT	TR22508	BANDA-ALT-AA	9620
BANDA-VENT	TR22534	BANDA-ALT	2/9550PB
MANGUERA SILICÓN-TUBO A RAD.	SIH250363C	BANDA-ALT	9550
MANGUERA SILICÓN-TUBO A RAD.	SIH300363C	TERMOSTATO-190°	33579



TERMOSTATO-180°	33576	MANGUERA SILICÓN-	SIH250363C
TERMOSTATO-180°	33578	1993	
TERMOSTATO-170°	33577	BANDA-VENT- OPCIONAL	9635
1991		BANDA-VENT	2/9640PB
BANDA-VENT	2/TR22517PB	BANDA-ALT-AA	2/9530PB
BANDA-VENT	TR22508	BANDA-ALT-AA	9530
BANDA-VENT	TR22517	TERMOSTATO-175°	33549
BANDA-VENT	TR22534	MANGUERA DE AGUA-	30T 3/4"
BANDA-ALT-AA	9600	MANGUERA SILICÓN-	SIH250363C
BANDA-ALT-AA	9620	1992	
BANDA-ALT	2/9550PB	BANDA-VENT	2/9530PB
BANDA-ALT	9550	BANDA-VENT	9530
TERMOSTATO-190°	33579	MANGUERA INFERIOR-TUBO A RAD.	21472
TERMOSTATO-180°	33576	MANGUERA SUPERIOR-TUBO A RAD.	23562
TERMOSTATO-180°	33578	MANGUERA INFERIOR-MOTOR A TUBO	23562
TERMOSTATO-170°	33577	MANGUERA SUPERIOR-MOTOR A TUBO	21891
1990		MANGUERA SUPERIOR-MOTOR A TUBO	23562
BANDA-VENT	TR22508	BANDA-ALT-AA	2/9550PB
BANDA-VENT	TR22517	BANDA-ALT-AA	9550
BANDA-VENT	TR22534	TERMOSTATO-175°	33549
BANDA-ALT-AA	8600 GS	MANGUERA DE AGUA-	30T 3/4"
BANDA-ALT-AA	9620	MANGUERA DE AGUA-	30T 5/8"
BANDA-ALT	2/9550PB	1991	
BANDA-ALT	PQ17550	BANDA-VENT	2/9530PB
CATERPILLAR 3306 DIESEL			
2000		BANDA-VENT	9530
TERMOSTATO-175°	33549	MANGUERA INFERIOR-TUBO A RAD.	21472
1999		MANGUERA SUPERIOR-TUBO A RAD.	23562
TERMOSTATO-175°	33549	MANGUERA INFERIOR-MOTOR-TUBO	23562
1998		MANGUERA SUPERIOR-MOTOR A TUBO	21891
TERMOSTATO-175°	33549	MANGUERA SUPERIOR-MOTOR A TUBO	23562
1997		BANDA-ALT-AA	2/9550PB
TERMOSTATO-175°	33549	BANDA-ALT-AA	9550
1996		TERMOSTATO-175°	33549
TERMOSTATO-175°	33549	MANGUERA DE AGUA-	30T 3/4"
1995		MANGUERA DE AGUA-	30T 5/8"
TERMOSTATO-175°	33549	CATERPILLAR 3176 DIESEL	
1994		1996	
BANDA-VENT- OPCIONAL	9635	BANDA-ALT-VENT	K080680
BANDA-VENT	2/9640PB	BANDA-ALT-VENT	K080733
BANDA-ALT-AA	2/9530PB	BANDA-ALT-VENT	K080740
BANDA-ALT-AA	9530	BANDA-ALT-VENT	K080751
TERMOSTATO-175°	33549	TERMOSTATO-190°	33579
MANGUERA DE AGUA-	30T 3/4"	TERMOSTATO-180°	33576



MASTER SERVICIO PESADO 2014

FREIGHTLINER

FLD

TERMOSTATO-180°	33578	BANDA-	9510
TERMOSTATO-170°	33577	MANGUERA DE AGUA-	30T 3/4"
BANDA-	9451	MANGUERA DE AGUA-	30T 5/8"
BANDA-	9470	1993	
BANDA-	9480	MANGUERA SILICÓN-TUBO A RAD.	SIH250363C
BANDA-	9500	MANGUERA INFERIOR-MOTOR A TUBO	24436
BANDA-	9510	MANGUERA SILICÓN-MOTOR A TUBO	SIH200363C
1995		BANDA-ALT-VENT	K080680
MANGUERA SILICÓN-TUBO A RAD.	SIH250363C	BANDA-ALT-VENT	K080733
MANGUERA INFERIOR-MOTOR A TUBO	24436	BANDA-ALT-VENT	K080740
MANGUERA SILICÓN-MOTOR A TUBO	SIH200363C	BANDA-ALT-VENT	K080751
BANDA-ALT-VENT	K080680	BANDA-AA	9451
BANDA-ALT-VENT	K080733	BANDA-AA	9470
BANDA-ALT-VENT	K080740	BANDA-AA	9480
BANDA-ALT-VENT	K080751	BANDA-AA	9500
TERMOSTATO-190°	33579	TERMOSTATO-190°	33579
TERMOSTATO-180°	33576	TERMOSTATO-180°	33576
TERMOSTATO-180°	33578	TERMOSTATO-180°	33578
TERMOSTATO-170°	33577	TERMOSTATO-170°	33577
BANDA-	9451	BANDA-	9510
BANDA-	9470	MANGUERA DE AGUA-	30T 3/4"
BANDA-	9480	MANGUERA DE AGUA-	30T 5/8"
BANDA-	9500	1992	
BANDA-	9510	MANGUERA SILICÓN-TUBO A RAD.	SIH250363C
MANGUERA DE AGUA-	30T 3/4"	MANGUERA INFERIOR-MOTOR-TUBO	24436
MANGUERA DE AGUA-	30T 5/8"	MANGUERA SILICÓN-MOTOR A TUBO	SIH200363C
1994		BANDA-ALT-VENT	K080680
MANGUERA SILICÓN-TUBO A RAD.	SIH250363C	BANDA-ALT-VENT	K080733
MANGUERA INFERIOR-MOTOR A TUBO	24436	BANDA-ALT-VENT	K080740
MANGUERA SILICÓN-MOTOR A TUBO	SIH200363C	BANDA-ALT-VENT	K080751
BANDA-ALT-VENT	K080680	BANDA-AA	9451
BANDA-ALT-VENT	K080733	BANDA-AA	9470
BANDA-ALT-VENT	K080740	BANDA-AA	9480
BANDA-ALT-VENT	K080751	BANDA-AA	9500
TERMOSTATO-190°	33579	BANDA-AA	9510
TERMOSTATO-180°	33576	TERMOSTATO-190°	33579
TERMOSTATO-180°	33578	TERMOSTATO-180°	33576
TERMOSTATO-170°	33577	TERMOSTATO-180°	33578
BANDA-	9451	TERMOSTATO-170°	33577
BANDA-	9470	MANGUERA DE AGUA-	30T 3/4"
BANDA-	9480	MANGUERA DE AGUA-	30T 5/8"
BANDA-	9500	1991	
		MANGUERA SILICÓN-TUBO A RAD.	SIH250363C



MASTER SERVICIO PESADO 2014

FREIGHTLINER

FLD

MANGUERA INFERIOR-MOTOR-TUBO	24436	BANDA-VENT	PQ28437
MANGUERA SILICÓN-MOTOR A TUBO	SIH200363C	BANDA-BA	K060435
BANDA-ALT-VENT	K080680	BANDA-ALT	PQ17460
BANDA-ALT-VENT	K080733	BANDA-AA	PQ17430
BANDA-ALT-VENT	K080740	CUMMINS N14 DIESEL	
BANDA-ALT-VENT	K080751	2000	
BANDA-AA	9451	BANDA-VENT	PQ24434
BANDA-AA	9470	BANDA-ALT	PQ28480
BANDA-AA	9480	1997	
BANDA-AA	9500	BANDA-VENT	K060415
BANDA-AA	9510	BANDA-VENT	PQ28437
TERMOSTATO-190°	33579	BANDA-BA	K060495
TERMOSTATO-180°	33576	BANDA-ALT	PQ17450
TERMOSTATO-180°	33578	BANDA-AA	PQ17440
TERMOSTATO-170°	33577	1996	
MANGUERA DE AGUA-	30T 3/4"	BANDA-VENT	K060415
MANGUERA DE AGUA-	30T 5/8"	BANDA-VENT	PQ28437
FLD120		BANDA-BA	K060495
DETROIT DIESEL SERIE 60		BANDA-ALT	PQ17450
2001		BANDA-AA	PQ17440
BANDA-VENT	BX50	1995	
POLEA-LOCA	38075	BANDA-VENT	K060415
BANDA-ALT	K080580	BANDA-VENT	PQ28437
TENSOR-	38501	BANDA-BA	K060495
2000		BANDA-ALT	PQ17450
POLEA-LOCA	38075	BANDA-AA	PQ17440
TENSOR-	38501	1994	
1999		BANDA-VENT	K060415
POLEA-LOCA	38075	BANDA-VENT	PQ28437
TENSOR-	38501	BANDA-BA	K060495
1997		BANDA-ALT	PQ17450
BANDA-VENT	PQ17530	BANDA-AA	PQ17440
1993		1993	
BANDA-VENT	PQ17530	BANDA-VENT	PQ28429
BANDA-AA	8573 GS	BANDA-ALT	PQ17450
1992		BANDA-AA	PQ17440
BANDA-VENT	PQ17530	CUMMINS M11 DIESEL	
BANDA-AA	8573 GS	1996	
1991		BANDA-VENT	K080575
BANDA-VENT	8573 GS	BANDA-ALT	K050345
BANDA-VENT	PQ17530	BANDA-AA	PQ17540
CUMMINS NTC 350		1995	
1993		BANDA-VENT	K080575



BANDA-ALT	K050345	2005	
BANDA-AA	PQ17540	TERMOSTATO-190°	33579
1994		TERMOSTATO-180°	33576
BANDA-VENT	K080585	TERMOSTATO-180°	33578
BANDA-ALT	K050340	TERMOSTATO-170°	33577
BANDA-AA	PQ17530	2004	
CUMMINS ISM DIESEL		TERMOSTATO-190°	33579
2002		TERMOSTATO-180°	33576
TENSOR-TOMA DE FUERZA-AA	38505	TERMOSTATO-180°	33578
BANDA-ALT-VENT	K080760	TERMOSTATO-170°	33577
TENSOR-ALT-VENT	38521	CATERPILLAR C7 DIESEL	
BANDA-AA	K060575	2007	
POLEA DEL TENSOR-	36091	TERMOSTATO-190°	33969
2001		TERMOSTATO-180°	33968
TENSOR-TOMA DE FUERZA-AA	38505	2006	
BANDA-ALT-VENT	K080760	TERMOSTATO-190°	33969
TENSOR-ALT-VENT	38521	TERMOSTATO-180°	33968
BANDA-AA	K060575	2005	
POLEA DEL TENSOR-	36091	POLEA-MOTOR	36091
CUMMINS ISM 370		TERMOSTATO-190°	33969
2000		TERMOSTATO-180°	33968
BANDA-VENT	K080590	2004	
CUMMINS ISC DIESEL		TERMOSTATO-190°	33969
2006		TERMOSTATO-180°	33968
TERMOSTATO-180°-C/DOBLE TERMOSTATO	33966	CATERPILLAR C13 DIESEL	
TERMOSTATO-180°	33959	2006	
2005		TERMOSTATO-190°	33579
TERMOSTATO-180°-C/DOBLE TERMOSTATO	33966	TERMOSTATO-180°	33576
TERMOSTATO-180°	33959	TERMOSTATO-180°	33578
2004		TERMOSTATO-170°	33577
TERMOSTATO-180°-C/DOBLE TERMOSTATO	33966	2005	
TERMOSTATO-180°	33959	BANDA-TOMA DE FUERZA-ALT-VENT-AA	K081020
2003		TENSOR-TOMA DE FUERZA-ALT-VENT-AA	38590
TERMOSTATO-180°-C/DOBLE TERMOSTATO	33966	POLEA-MOTOR	36093
TERMOSTATO-180°	33959	TERMOSTATO-190°	33579
2002		TERMOSTATO-180°	33576
TERMOSTATO-180°-C/DOBLE TERMOSTATO	33966	TERMOSTATO-180°	33578
TERMOSTATO-180°	33959	TERMOSTATO-170°	33577
CATERPILLAR C9 DIESEL		2004	
2006		POLEA-MOTOR	36093
TERMOSTATO-190°	33579	TERMOSTATO-190°	33579
TERMOSTATO-180°	33576	TERMOSTATO-180°	33576
TERMOSTATO-180°	33578	TERMOSTATO-180°	33578
TERMOSTATO-170°	33577	TERMOSTATO-170°	33577

**CATERPILLAR C12 DIESEL****2004**

POLEA DEL TENSOR-VENT-AA	36091
TENSOR-VENT-AA	38524
POLEA DEL TENSOR-TOMA DE FUERZA-ALT-VENT	36091
TENSOR-TOMA DE FUERZA-ALT-VENT	38506
BANDA-ALT-VENT	K080878
POLEA-ALT-VENT	36091
BANDA-AA	K060495
TERMOSTATO-190°	33579
TERMOSTATO-180°	33576
TERMOSTATO-180°	33578
TERMOSTATO-170°	33577

2003

POLEA DEL TENSOR-VENT-AA	36091
TENSOR-VENT-AA	38524
POLEA DEL TENSOR-TOMA DE FUERZA-ALT-VENT	36091
TENSOR-TOMA DE FUERZA-ALT-VENT	38506
BANDA-ALT-VENT	K080878
POLEA-ALT-VENT	36091
BANDA-AA	K060495
TERMOSTATO-190°	33579
TERMOSTATO-180°	33576
TERMOSTATO-180°	33578
TERMOSTATO-170°	33577

2002

POLEA DEL TENSOR-VENT-AA	36091
TENSOR-VENT-AA	38524
POLEA DEL TENSOR-TOMA DE FUERZA-ALT-VENT	36091
TENSOR-TOMA DE FUERZA-ALT-VENT	38506
BANDA-ALT-VENT	K080878
POLEA-ALT-VENT	36091
BANDA-AA	K060495
TERMOSTATO-190°	33579
TERMOSTATO-180°	33576
TERMOSTATO-180°	33578
TERMOSTATO-170°	33577

2001

POLEA DEL TENSOR-VENT-AA	36091
TENSOR-VENT-AA	38524
POLEA DEL TENSOR-TOMA DE FUERZA-ALT-VENT	36091
TENSOR-TOMA DE FUERZA-ALT-VENT	38506
BANDA-ALT-VENT	K080878

POLEA-ALT-VENT	36091
BANDA-AA	K060495
TERMOSTATO-190°	33579
TERMOSTATO-180°	33576
TERMOSTATO-180°	33578
TERMOSTATO-170°	33577

CATERPILLAR C11 DIESEL**2006**

TERMOSTATO-190°	33579
TERMOSTATO-180°	33576
TERMOSTATO-180°	33578
TERMOSTATO-170°	33577

2005

BANDA-TOMA DE FUERZA-ALT-VENT-AA	K081020
TENSOR-TOMA DE FUERZA-ALT-VENT-AA	38590
POLEA-MOTOR	36093
TERMOSTATO-190°	33579
TERMOSTATO-180°	33576
TERMOSTATO-180°	33578
TERMOSTATO-170°	33577

2004

POLEA-MOTOR	36093
TERMOSTATO-190°	33579
TERMOSTATO-180°	33576
TERMOSTATO-180°	33578
TERMOSTATO-170°	33577

CATERPILLAR C10 DIESEL**2004**

POLEA DEL TENSOR-VENT-AA	36091
TENSOR-VENT-AA	38524
POLEA DEL TENSOR-TOMA DE FUERZA-ALT-VENT	36091
TENSOR-TOMA DE FUERZA-ALT-VENT	38506
BANDA-ALT-VENT	K080878
POLEA-ALT-VENT	36091
BANDA-AA	K060495
TERMOSTATO-190°	33579
TERMOSTATO-180°	33576
TERMOSTATO-180°	33578
TERMOSTATO-170°	33577

2003

POLEA DEL TENSOR-VENT-AA	36091
TENSOR-VENT-AA	38524
POLEA DEL TENSOR-TOMA DE FUERZA-ALT-VENT	36091



TENSOR-TOMA DE FUERZA-ALT-VENT	38506
BANDA-ALT-VENT	K080878
POLEA-ALT-VENT	36091
BANDA-AA	K060495
TERMOSTATO-190°	33579
TERMOSTATO-180°	33576
TERMOSTATO-180°	33578
TERMOSTATO-170°	33577

2002

POLEA DEL TENSOR-VENT-AA	36091
TENSOR-VENT-AA	38524
POLEA DEL TENSOR-TOMA DE FUERZA-ALT-VENT	36091
TENSOR-TOMA DE FUERZA-ALT-VENT	38506
BANDA-ALT-VENT	K080878
POLEA-ALT-VENT	36091
BANDA-AA	K060495
TERMOSTATO-190°	33579
TERMOSTATO-180°	33576
TERMOSTATO-180°	33578
TERMOSTATO-170°	33577

2001

POLEA DEL TENSOR-VENT-AA	36091
TENSOR-VENT-AA	38524
POLEA DEL TENSOR-TOMA DE FUERZA-ALT-VENT	36091
TENSOR-TOMA DE FUERZA-ALT-VENT	38506
BANDA-ALT-VENT	K080878
POLEA-ALT-VENT	36091
BANDA-AA	K060495
TERMOSTATO-190°	33579
TERMOSTATO-180°	33576
TERMOSTATO-180°	33578
TERMOSTATO-170°	33577

CATERPILLAR 3126 DIESEL

2004

TERMOSTATO-190°	33969
TERMOSTATO-180°	33968

2003

TERMOSTATO-190°	33969
TERMOSTATO-180°	33968

2002

TERMOSTATO-190°	33969
TERMOSTATO-180°	33968

2001

TERMOSTATO-190°	33969
TERMOSTATO-180°	33968

GIANT MOTORS



GF-3600

GIANT SUPER DIESEL CA4C32-10E3

2008

BANDA-BA-DH-VENT	AX43
BANDA-ALT-BA	AX46

2007

BANDA-BA-DH-VENT	AX43
BANDA-ALT-BA	AX46

GF-8

4 CIL, 1.0 L

2008

BANDA-MOTOR	9319
BANDA-ÁRBOL DE LEVAS (88D X 19MM)	T070
TAPÓN DE RADIADOR-(13 LBS) SIN PALANCA	31333

2007

BANDA-MOTOR	9319
BANDA-ÁRBOL DE LEVAS (88D X 19MM)	T070
TAPÓN DE RADIADOR-(13 LBS) SIN PALANCA	31333

GF-900

4 CIL, 1.0 L

2008

BANDA-MOTOR	9319
BANDA-ÁRBOL DE LEVAS (88D X 19MM)	T070
TAPÓN DE RADIADOR-(13 LBS) SIN PALANCA	31333

2007

BANDA-MOTOR	9319
BANDA-ÁRBOL DE LEVAS (88D X 19MM)	T070
TAPÓN DE RADIADOR-(13 LBS) SIN PALANCA	31333

HINO



1018 SERIE 500

HINO J05D-TG

2013

BANDA-MOTOR OPCIÓN 2	8468 GS
BANDA-MOTOR OPCIÓN 1	9463

2012



MASTER SERVICIO PESADO 2014

HINO

1018 SERIE 500

BANDA-MOTOR OPCIÓN 2 8468 GS

BANDA-MOTOR OPCIÓN 1 9463

1524 SERIE 500

HINO J08-ETE

2013

BANDA-MOTOR K080550

2012

BANDA-MOTOR K080550

2011

BANDA-MOTOR K080550

2010

BANDA-MOTOR K080550

1714 SERIE 500

HINO J80E-ETB

2013

BANDA-MOTOR K080550

2012

BANDA-MOTOR K080550

2011

BANDA-MOTOR K080550

2010

BANDA-MOTOR K080550

1727 SERIE 500

HINO J80E-ETB

2013

BANDA-MOTOR K080550

2012

BANDA-MOTOR K080550

2011

BANDA-MOTOR K080550

2010

BANDA-MOTOR K080550

414 SERIE 300

HINO N04C-TUV

2011

BANDA-COMPRESOR A38

BANDA-ALT-BA-VENT A48

2010

BANDA-COMPRESOR A38

BANDA-ALT-BA-VENT A48

514 SERIE 300

HINO N04C-UV

2013

BANDA-COMPRESOR

A38

BANDA-ALT-BA-VENT

A48

2012

BANDA-COMPRESOR A38

BANDA-ALT-BA-VENT A48

616 SERIE 300

HINO N04C-UV

2013

BANDA-COMPRESOR A38

BANDA-ALT-BA-VENT A48

2012

BANDA-COMPRESOR A38

BANDA-ALT-BA-VENT A48

HINO N04C-TUV

2011

BANDA-COMPRESOR A38

BANDA-ALT-BA-VENT A48

2010

BANDA-COMPRESOR A38

BANDA-ALT-BA-VENT A48

2009

BANDA-COMPRESOR A38

BANDA-ALT-BA-VENT A48

HINO N04C-TT

2008

BANDA-COMPRESOR A38

BANDA-ALT-BA-VENT A48

2007

BANDA-COMPRESOR A38

BANDA-ALT-BA-VENT A48

716 SERIE 300

HINO N04C-UV

2013

BANDA-COMPRESOR A38

BANDA-ALT-BA-VENT A48

2012

BANDA-COMPRESOR A38

BANDA-ALT-BA-VENT A48

HINO N04C-TUV

2011

BANDA-COMPRESOR A38

BANDA-ALT-BA-VENT A48

2010

BANDA-COMPRESOR A38



MASTER SERVICIO PESADO 2014

HINO

716 SERIE 300

BANDA-ALT-BA-VENT	A48	2001	TERMOSTATO-195°	33967
2009				
BANDA-COMPRESOR	A38	2000	TERMOSTATO-195°	33967
BANDA-ALT-BA-VENT	A48			
HINO N04C-TT		INTERNATIONAL/NAVISTAR DT466		
2008		2002	TERMOSTATO-190°	33179
BANDA-COMPRESOR	A38		TERMOSTATO-190°	33957
BANDA-ALT-BA-VENT	A48		TERMOSTATO-180°	33118
2007		2001	TERMOSTATO-190°	33179
BANDA-COMPRESOR	A38		TERMOSTATO-190°	33957
BANDA-ALT-BA-VENT	A48		TERMOSTATO-180°	33118
816 SERIE 300				
HINO N04C-UV		2000	TERMOSTATO-190°	33179
2013			TERMOSTATO-190°	33957
BANDA-COMPRESOR	A38		TERMOSTATO-180°	33118
BANDA-ALT-BA-VENT	A48			
2012		1999	TERMOSTATO-190°	33179
BANDA-COMPRESOR	A38		TERMOSTATO-190°	33957
BANDA-ALT-BA-VENT	A48		TERMOSTATO-180°	33118
HINO N04C-TUV		1998	TERMOSTATO-190°	33179
2011			TERMOSTATO-190°	33957
BANDA-COMPRESOR	A38		TERMOSTATO-180°	33118
BANDA-ALT-BA-VENT	A48			
2010				
BANDA-COMPRESOR	A38			
BANDA-ALT-BA-VENT	A48			
2009				
BANDA-COMPRESOR	A38			
BANDA-ALT-BA-VENT	A48			
HINO N04C-TT		INTERNATIONAL/NAVISTAR DT466		
2008		2007	TERMOSTATO-190°	33179
BANDA-COMPRESOR	A38		TERMOSTATO-190°	33957
BANDA-ALT-BA-VENT	A48		TERMOSTATO-180°	33118
2007		2006	TERMOSTATO-190°	33179
BANDA-COMPRESOR	A38		TERMOSTATO-190°	33957
BANDA-ALT-BA-VENT	A48		TERMOSTATO-180°	33118
2005		2005	BANDA-MOTOR	K080740
			TERMOSTATO-190°	33179
			TERMOSTATO-190°	33957
			TERMOSTATO-180°	33118
		2004	TENSOR-MOTOR	38514
			TERMOSTATO-190°	33179
			TERMOSTATO-190°	33957

INTERNATIONAL/ NAVISTAR



3000FE

INTERNATIONAL/NAVISTAR T444 DIESEL

2002

TERMOSTATO-195° 33967



TERMOSTATO-180°	33118	BANDA-ALT-BA-VENT	K081124
POLEA DEL TENSOR-	36091	TERMOSTATO-195°	33967
3400		2001	
INTERNATIONAL/NAVISTAR T444 DIESEL		MANGUERA SILICÓN-TUBO A TUBO	SIH300363C
2002		MANGUERA INFERIOR-TUBO A RAD.	21042
TERMOSTATO-195°	33967	MANGUERA INFERIOR-MOTOR A TUBO	21042
2001		MANGUERA SUPERIOR-MOTOR A TUBO	22159
TERMOSTATO-195°	33967	TENSOR-MOTOR	38510
2000		BANDA-ALT-BA-VENT	K080893
TERMOSTATO-195°	33967	BANDA-ALT-BA-VENT	K081124
1999		TERMOSTATO-195°	33967
MANGUERA INFERIOR-MOTOR A RAD.	22843	2000	
BANDA-MOTOR	K081124	MANGUERA SUPERIOR-RAD. A MOTOR	22159
TERMOSTATO-195°	33967	MANGUERA INFERIOR-MOTOR A TUBO	22782
MANGUERA SUPERIOR-	22159	TENSOR-MOTOR	38510
1998		BANDA-ALT-BA-VENT	K080893
BANDA-MOTOR	K081124	BANDA-ALT-BA-VENT	K081124
TERMOSTATO-195°	33967	TERMOSTATO-195°	33967
MANGUERA SUPERIOR-	22159	1999	
3600		MANGUERA INFERIOR-MOTOR A RAD.	22843
INTERNATIONAL/NAVISTAR T444 DIESEL		TENSOR-MOTOR	38510
1999		BANDA-ALT-BA-VENT	K080893
TERMOSTATO-195°	33967	BANDA-ALT-BA-VENT	K081124
1998		BANDA-AA	K081265
TERMOSTATO-195°	33967	TERMOSTATO-195°	33967
INTERNATIONAL/NAVISTAR DT466		1998	
1999		MANGUERA INFERIOR-MOTOR A RAD.	22671
TERMOSTATO-190°	33179	TENSOR-MOTOR	38510
TERMOSTATO-190°	33957	BANDA-ALT-BA-VENT	K080893
TERMOSTATO-180°	33118	BANDA-ALT-BA-VENT	K081124
1998		TERMOSTATO-195°	33967
TERMOSTATO-190°	33179	INTERNATIONAL/NAVISTAR DT466	
TERMOSTATO-190°	33957	2004	
TERMOSTATO-180°	33118	TERMOSTATO-190°	33179
3800		TERMOSTATO-190°	33957
INTERNATIONAL/NAVISTAR T444 DIESEL		TERMOSTATO-180°	33118
2004		2003	
TERMOSTATO-195°	33967	TERMOSTATO-190°	33179
2003		TERMOSTATO-190°	33957
TERMOSTATO-195°	33967	TERMOSTATO-180°	33118
2002		2002	
TENSOR-MOTOR	38510	BANDA-VENT	K080690
BANDA-ALT-BA-VENT	K080893	TERMOSTATO-190°	33179



MASTER SERVICIO PESADO 2014

INTERNATIONAL/
NAVISTAR
3800

TERMOSTATO-190°	33957	MANGUERA SUPERIOR-MOTOR A RAD.	22774
TERMOSTATO-180°	33118	BANDA-ALT-VENT-AA	K080830
2001		TENSOR-ALT-VENT-AA	38556
BANDA-TOMA DE FUERZA-ALT-VENT	K080726	2006	
POLEA DEL TENSOR-TOMA DE FUERZA-ALT-VENT	36091	MANGUERA INFERIOR-MOTOR A RAD.	22775
TENSOR-TOMA DE FUERZA-ALT-VENT	38514	MANGUERA SUPERIOR-MOTOR A RAD.	22774
MANGUERA INFERIOR-MOTOR A RAD.	20987	BANDA-ALT-VENT-AA	K080830
MANGUERA SUPERIOR-MOTOR A RAD.	22140	TENSOR-ALT-VENT-AA	38556
TERMOSTATO-190°	33179	4200	
TERMOSTATO-190°	33957	INTERNATIONAL/NAVISTAR VT365 DIESEL	
TERMOSTATO-180°	33118	2007	
2000		BANDA-VENT-COMPRESOR	K060509
BANDA-TOMA DE FUERZA-ALT-VENT	K080726	MANGUERA INFERIOR-MOTOR A RAD.	22775
POLEA DEL TENSOR-TOMA DE FUERZA-ALT-VENT	36091	MANGUERA SUPERIOR-MOTOR A RAD.	22774
TENSOR-TOMA DE FUERZA-ALT-VENT	38514	BANDA-ALT-VENT-AA	K080830
MANGUERA INFERIOR-MOTOR A RAD.	22762	TENSOR-ALT-VENT-AA	38556
MANGUERA SUPERIOR-MOTOR A RAD.	22140	2006	
TERMOSTATO-190°	33179	BANDA-VENT-COMPRESOR	K060509
TERMOSTATO-190°	33957	MANGUERA INFERIOR-MOTOR A RAD.	22775
TERMOSTATO-180°	33118	MANGUERA SUPERIOR-MOTOR A RAD.	22774
1999		BANDA-ALT-VENT-AA	K080830
MANGUERA INFERIOR-MOTOR A RAD.	22762	TENSOR-ALT-VENT-AA	38556
MANGUERA SUPERIOR-MOTOR A RAD.	22140	TERMOSTATO-190°	33958
BANDA-MOTOR	K080730	2005	
TENSOR-MOTOR	38514	BANDA-VENT-COMPRESOR	K060509
TERMOSTATO-190°	33179	MANGUERA INFERIOR-MOTOR A RAD.	22775
TERMOSTATO-190°	33957	MANGUERA SUPERIOR-MOTOR A RAD.	22774
TERMOSTATO-180°	33118	BANDA-ALT-VENT-AA	K080830
POLEA DEL TENSOR-	36091	TENSOR-ALT-VENT-AA	38556
1998		TERMOSTATO-190°	33958
MANGUERA SUPERIOR-MOTOR A RAD.	22140	2004	
BANDA-MOTOR	K080730	BANDA-VENT-COMPRESOR	K060509
TENSOR-MOTOR	38514	MANGUERA INFERIOR-MOTOR A RAD.	22775
TERMOSTATO-190°	33179	MANGUERA SUPERIOR-MOTOR A RAD.	22774
TERMOSTATO-190°	33957	BANDA-ALT-VENT-AA	K080830
TERMOSTATO-180°	33118	TENSOR-ALT-VENT-AA	38556
MANGUERA DE PASO-	21457	TERMOSTATO-190°	33958
MANGUERA INFERIOR-	22762	2003	
POLEA DEL TENSOR-	36091	BANDA-VENT-COMPRESOR	K060525
4100		MANGUERA INFERIOR-MOTOR A RAD.	22775
INTERNATIONAL/NAVISTAR VT365 DIESEL		MANGUERA SUPERIOR-MOTOR A RAD.	22774
2007		BANDA-ALT-VENT-AA	K080830
MANGUERA INFERIOR-MOTOR A RAD.	22775	TENSOR-ALT-VENT-AA	38556



MASTER SERVICIO PESADO 2014

INTERNATIONAL/
NAVISTAR
4200

2002

BANDA-VENT-COMPRESOR	K060525
MANGUERA INFERIOR-MOTOR A RAD.	22775
MANGUERA SUPERIOR-MOTOR A RAD.	22774
BANDA-ALT-VENT-AA	K080830
TENSOR-ALT-VENT-AA	38556

TAPÓN DE RADIADOR-(10 LBS) SIN PALANCA	31567
BOMBA DE AGUA-	43325HD

2005

MANGUERA INFERIOR-MOTOR A RAD.	22742
MANGUERA SUPERIOR-MOTOR A RAD.	20731
BANDA-ALT-VENT-AA	K080825
TENSOR-ALT-VENT-AA	38620
TERMOSTATO-190°	33179
TERMOSTATO-190°	33957
TERMOSTATO-180°	33118

4300

INTERNATIONAL/NAVISTAR VT365 DIESEL

2003

BANDA-VENT-COMPRESOR	K060525
MANGUERA INFERIOR-MOTOR A RAD.	22775
MANGUERA SUPERIOR-MOTOR A RAD.	22774
BANDA-ALT-VENT-AA	K080830
TENSOR-ALT-VENT-AA	38556

TAPÓN DE RADIADOR-(10 LBS) SIN PALANCA	31567
BOMBA DE AGUA-	43325HD

2004

BANDA-VENT-AA	K060490
POLEA DEL TENSOR-VENT-AA	36091
TENSOR-VENT-AA	38511
BANDA-TOMA DE FUERZA-ALT-VENT	K080702

INTERNATIONAL/NAVISTAR DT466

2008

MANGUERA INFERIOR-MOTOR A RAD.	22742
MANGUERA SUPERIOR-MOTOR A RAD.	20731
BANDA-ALT-VENT-AA	K080825
TENSOR-ALT-VENT-AA	38620
TERMOSTATO-190°	33179
TERMOSTATO-190°	33957
TERMOSTATO-180°	33118
TAPÓN DE RADIADOR-(10 LBS) SIN PALANCA	31567
BOMBA DE AGUA-	43325HD

POLEA DEL TENSOR-TOMA DE FUERZA-ALT-VENT	36091
TENSOR-TOMA DE FUERZA-ALT-VENT	38514
MANGUERA INFERIOR-MOTOR A RAD.	22742
MANGUERA SUPERIOR-MOTOR A RAD.	20731
TERMOSTATO-190°	33179
TERMOSTATO-190°	33957
TERMOSTATO-180°	33118
TAPÓN DE RADIADOR-(10 LBS) SIN PALANCA	31567
BOMBA DE AGUA-	43325HD

2007

MANGUERA INFERIOR-MOTOR A RAD.	22742
MANGUERA SUPERIOR-MOTOR A RAD.	20731
BANDA-ALT-VENT-AA	K080825
TENSOR-ALT-VENT-AA	38620
TERMOSTATO-190°	33179
TERMOSTATO-190°	33957
TERMOSTATO-180°	33118
TAPÓN DE RADIADOR-(10 LBS) SIN PALANCA	31567
BOMBA DE AGUA-	43325HD

2003

BANDA-VENT-AA	K060490
POLEA DEL TENSOR-VENT-AA	36091
TENSOR-VENT-AA	38511
BANDA-TOMA DE FUERZA-ALT-VENT	K080702

2006

MANGUERA INFERIOR-MOTOR A RAD.	22742
MANGUERA SUPERIOR-MOTOR A RAD.	20731
BANDA-ALT-VENT-AA	K080825
TENSOR-ALT-VENT-AA	38620
TERMOSTATO-190°	33179
TERMOSTATO-190°	33957
TERMOSTATO-180°	33118

POLEA DEL TENSOR-TOMA DE FUERZA-ALT-VENT	36091
TENSOR-TOMA DE FUERZA-ALT-VENT	38514
MANGUERA INFERIOR-MOTOR A RAD.	22742
MANGUERA SUPERIOR-MOTOR A RAD.	20731
TERMOSTATO-190°	33179
TERMOSTATO-190°	33957
TERMOSTATO-180°	33118
TAPÓN DE RADIADOR-(10 LBS) SIN PALANCA	31567
BOMBA DE AGUA-	43325HD

2002

BANDA-VENT-AA	K060490
POLEA DEL TENSOR-VENT-AA	36091



MASTER SERVICIO PESADO 2014

INTERNATIONAL/
NAVISTAR
4300

TENSOR-VENT-AA	38511	MANGUERA INFERIOR-ENFRIADOR A RAD.	21891
BANDA-TOMA DE FUERZA-ALT-VENT	K080700	BANDA-ALT-VENT-AA	K080825
POLEA DEL TENSOR-TOMA DE FUERZA-ALT-VENT	36091	TENSOR-ALT-VENT-AA	38620
TENSOR-TOMA DE FUERZA-ALT-VENT	38514	TERMOSTATO-190°	33179
MANGUERA INFERIOR-MOTOR A RAD.	22742	TERMOSTATO-190°	33957
MANGUERA SUPERIOR-MOTOR A RAD.	20731	TERMOSTATO-180°	33118
TERMOSTATO-190°	33179	TAPÓN DE RADIADOR-(10 LBS) SIN PALANCA	31567
TERMOSTATO-190°	33957	BOMBA DE AGUA-	43325HD
TERMOSTATO-180°	33118	2007	
TAPÓN DE RADIADOR-(10 LBS) SIN PALANCA	31567	MANGUERA SUPERIOR-MOTOR A RAD.	20731
BOMBA DE AGUA-	43325HD	MANGUERA INFERIOR-ENFRIADOR A RAD.	21891
4400		BANDA-ALT-VENT-AA	K080825
INTERNATIONAL/NAVISTAR VT365 DIESEL		TENSOR-ALT-VENT-AA	38620
2003		TERMOSTATO-190°	33179
BANDA-VENT-COMPRESOR	K060525	TERMOSTATO-190°	33957
MANGUERA INFERIOR-MOTOR A RAD.	22775	TERMOSTATO-180°	33118
MANGUERA SUPERIOR-MOTOR A RAD.	22774	TAPÓN DE RADIADOR-(10 LBS) SIN PALANCA	31567
BANDA-ALT-VENT-AA	K080830	BOMBA DE AGUA-	43325HD
TENSOR-ALT-VENT-AA	38556	2006	
INTERNATIONAL/NAVISTAR DT570 DIESEL		MANGUERA SUPERIOR-MOTOR A RAD.	20731
2008		MANGUERA INFERIOR-ENFRIADOR A RAD.	21891
TENSOR-TOMA DE FUERZA-ALT-VENT-AA	38620	BANDA-ALT-VENT-AA	K080825
MANGUERA SUPERIOR-MOTOR A RAD.	20731	TENSOR-ALT-VENT-AA	38620
BANDA-MOTOR	K080845	TERMOSTATO-190°	33179
2007		TERMOSTATO-190°	33957
TENSOR-TOMA DE FUERZA-ALT-VENT-AA	38620	TERMOSTATO-180°	33118
MANGUERA SUPERIOR-MOTOR A RAD.	20731	TAPÓN DE RADIADOR-(10 LBS) SIN PALANCA	31567
BANDA-MOTOR	K080845	BOMBA DE AGUA-	43325HD
2006		2005	
TENSOR-TOMA DE FUERZA-ALT-VENT-AA	38620	BANDA-VENT-AA	K060490
MANGUERA SUPERIOR-MOTOR A RAD.	20731	POLEA DEL TENSOR-VENT-AA	36091
BANDA-MOTOR	K080845	TENSOR-VENT-AA	38511
2005		BANDA-TOMA DE FUERZA-ALT-VENT	K080702
TENSOR-TOMA DE FUERZA-ALT-VENT-AA	38620	POLEA DEL TENSOR-TOMA DE FUERZA-ALT-VENT	36091
MANGUERA SUPERIOR-MOTOR A RAD.	20731	TENSOR-TOMA DE FUERZA-ALT-VENT	38514
BANDA-MOTOR	K080845	MANGUERA INFERIOR-MOTOR A RAD.	22742
2004		MANGUERA SUPERIOR-MOTOR A RAD.	20731
TENSOR-TOMA DE FUERZA-ALT-VENT-AA	38620	TERMOSTATO-190°	33179
MANGUERA SUPERIOR-MOTOR A RAD.	20731	TERMOSTATO-190°	33957
BANDA-MOTOR	K080845	TERMOSTATO-180°	33118
INTERNATIONAL/NAVISTAR DT466		TAPÓN DE RADIADOR-(10 LBS) SIN PALANCA	31567
2008		2004	
MANGUERA SUPERIOR-MOTOR A RAD.	20731	BANDA-VENT-AA	K060490



MASTER SERVICIO PESADO 2014

INTERNATIONAL/
NAVISTAR
4400

POLEA DEL TENSOR-VENT-AA	36091	MANGUERA INFERIOR-MOTOR A RAD.	22742
TENSOR-VENT-AA	38511	MANGUERA SUPERIOR-MOTOR A RAD.	20731
BANDA-TOMA DE FUERZA-ALT-VENT	K080702	2004	
POLEA DEL TENSOR-TOMA DE FUERZA-ALT-VENT	36091	BANDA-VENT-AA	K060490
TENSOR-TOMA DE FUERZA-ALT-VENT	38514	POLEA DEL TENSOR-VENT-AA	36091
MANGUERA INFERIOR-MOTOR A RAD.	22742	TENSOR-VENT-AA	38511
MANGUERA SUPERIOR-MOTOR A RAD.	20731	BANDA-TOMA DE FUERZA-ALT-VENT	K080685
TERMOSTATO-190°	33179	POLEA DEL TENSOR-TOMA DE FUERZA-ALT-VENT	36091
TERMOSTATO-190°	33957	TENSOR-TOMA DE FUERZA-ALT-VENT	38514
TERMOSTATO-180°	33118	MANGUERA INFERIOR-MOTOR A RAD.	22742
TAPÓN DE RADIADOR-(10 LBS) SIN PALANCA	31567	MANGUERA SUPERIOR-MOTOR A RAD.	20731
2003		2003	
BANDA-VENT-AA	K060490	BANDA-VENT-AA	K060490
POLEA DEL TENSOR-VENT-AA	36091	POLEA DEL TENSOR-VENT-AA	36091
TENSOR-VENT-AA	38511	TENSOR-VENT-AA	38511
BANDA-TOMA DE FUERZA-ALT-VENT	K080702	BANDA-TOMA DE FUERZA-ALT-VENT	K080685
POLEA DEL TENSOR-TOMA DE FUERZA-ALT-VENT	36091	POLEA DEL TENSOR-TOMA DE FUERZA-ALT-VENT	36091
TENSOR-TOMA DE FUERZA-ALT-VENT	38514	TENSOR-TOMA DE FUERZA-ALT-VENT	38514
MANGUERA INFERIOR-MOTOR A RAD.	22742	MANGUERA INFERIOR-MOTOR A RAD.	22742
MANGUERA SUPERIOR-MOTOR A RAD.	20731	MANGUERA SUPERIOR-MOTOR A RAD.	20731
TERMOSTATO-190°	33179	2002	
TERMOSTATO-190°	33957	BANDA-VENT-AA	K060490
TERMOSTATO-180°	33118	POLEA DEL TENSOR-VENT-AA	36091
2002		TENSOR-VENT-AA	38511
BANDA-VENT-AA	K060490	BANDA-TOMA DE FUERZA-ALT-VENT	K080685
POLEA DEL TENSOR-VENT-AA	36091	POLEA DEL TENSOR-TOMA DE FUERZA-ALT-VENT	36091
TENSOR-VENT-AA	38511	TENSOR-TOMA DE FUERZA-ALT-VENT	38514
BANDA-TOMA DE FUERZA-ALT-VENT	K080700	MANGUERA INFERIOR-MOTOR A RAD.	22742
POLEA DEL TENSOR-TOMA DE FUERZA-ALT-VENT	36091	MANGUERA SUPERIOR-MOTOR A RAD.	20731
TENSOR-TOMA DE FUERZA-ALT-VENT	38514		
MANGUERA INFERIOR-MOTOR A RAD.	22742		
MANGUERA SUPERIOR-MOTOR A RAD.	20731		
TERMOSTATO-190°	33179		
TERMOSTATO-190°	33957		
TERMOSTATO-180°	33118		
		4600	
		INTERNATIONAL/NAVISTAR T444 DIESEL	
		1995	
		MANGUERA INFERIOR-TUBO A RAD.	20172
		MANGUERA INFERIOR-MOTOR A TUBO	22671
		MANGUERA SUPERIOR-MOTOR A RAD.	22159
		TENSOR-MOTOR	38510
INTERNATIONAL/NAVISTAR 530 DIESEL		BANDA-ALT-BA-VENT-C/VENT CLUTCH SCHWITZER, S/COMP DE FRENOS	K080893
2005		BANDA-ALT-BA-VENT-C/VENT CLUTCH SCHWITZER, S/COMP DE FRENOS	K080922
BANDA-VENT-AA	K060490	BANDA-ALT-BA-VENT-C/VENT CLUTCH SCHWITZER	K081102
POLEA DEL TENSOR-VENT-AA	36091		
TENSOR-VENT-AA	38511	BANDA-ALT-BA-VENT-AA-C/VENT CLUTCH SCHWITZER, S/COMP DE FRENOS	K081000
BANDA-TOMA DE FUERZA-ALT-VENT	K080685	BANDA-ALT-BA-VENT-AA-C/VENT CLUTCH SCHWITZER, S/COMP DE FRENOS	K081035
POLEA DEL TENSOR-TOMA DE FUERZA-ALT-VENT	36091	BANDA-ALT-BA-VENT-AA-C/VENT CLUTCH SCHWITZER	K081223
TENSOR-TOMA DE FUERZA-ALT-VENT	38514	BANDA-ALT-BA-VENT-AA	K081265

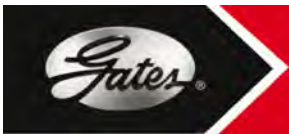

MASTER SERVICIO PESADO 2014

INTERNATIONAL/
NAVISTAR
4600

BANDA-ALT-BA-VENT	K081124	TERMOSTATO-195°	33967
TERMOSTATO-195°	33967	1999	
4700		MANGUERA INFERIOR-TUBO A RAD.	20172
INTERNATIONAL/NAVISTAR T444 DIESEL		MANGUERA INFERIOR-MOTOR A TUBO	22671
2002		MANGUERA SUPERIOR-MOTOR A RAD.	22159
MANGUERA INFERIOR-MOTOR A RAD.	22671	TENSOR-MOTOR	38510
MANGUERA SUPERIOR-MOTOR A RAD.	22159	BANDA-ALT-BA-VENT-C/VENT CLUTCH SCHWITZER, S/COMP DE FRENOS	K080893
TENSOR-MOTOR	38510	BANDA-ALT-BA-VENT-C/VENT CLUTCH SCHWITZER, S/COMP DE FRENOS	K080922
BANDA-ALT-BA-VENT-C/VENT CLUTCH SCHWITZER, S/COMP DE FRENOS	K080893	BANDA-ALT-BA-VENT-C/VENT CLUTCH SCHWITZER	K081102
BANDA-ALT-BA-VENT-C/VENT CLUTCH SCHWITZER, S/COMP DE FRENOS	K080922	BANDA-ALT-BA-VENT-AA-C/VENT CLUTCH SCHWITZER, S/COMP DE FRENOS	K081000
BANDA-ALT-BA-VENT-C/VENT CLUTCH SCHWITZER	K081102	BANDA-ALT-BA-VENT-AA-C/VENT CLUTCH SCHWITZER, S/COMP DE FRENOS	K081035
BANDA-ALT-BA-VENT-AA-C/VENT CLUTCH SCHWITZER, S/COMP DE FRENOS	K081000	BANDA-ALT-BA-VENT-AA-C/VENT CLUTCH SCHWITZER	K081223
BANDA-ALT-BA-VENT-AA-C/VENT CLUTCH SCHWITZER, S/COMP DE FRENOS	K081035	BANDA-ALT-BA-VENT-AA	K081265
BANDA-ALT-BA-VENT-AA-C/VENT CLUTCH SCHWITZER	K081223	BANDA-ALT-BA-VENT	K081124
BANDA-ALT-BA-VENT-AA	K081265	TERMOSTATO-195°	33967
BANDA-ALT-BA-VENT	K081124	1998	
2001		MANGUERA INFERIOR-TUBO A RAD.	20172
MANGUERA INFERIOR-MOTOR A RAD.	22671	MANGUERA INFERIOR-MOTOR A TUBO	22671
MANGUERA SUPERIOR-MOTOR A RAD.	22159	MANGUERA SUPERIOR-MOTOR A RAD.	22159
TENSOR-MOTOR	38510	TENSOR-MOTOR	38510
BANDA-ALT-BA-VENTV	K081102	BANDA-ALT-BA-VENT-C/VENT CLUTCH SCHWITZER, S/COMP DE FRENOS	K080893
BANDA-ALT-BA-VENT-C/VENT CLUTCH SCHWITZER, S/COMP DE FRENOS	K080893	BANDA-ALT-BA-VENT-C/VENT CLUTCH SCHWITZER, S/COMP DE FRENOS	K080922
BANDA-ALT-BA-VENT-C/VENT CLUTCH SCHWITZER, S/COMP DE FRENOS	K080922	BANDA-ALT-BA-VENT-C/VENT CLUTCH SCHWITZER	K081102
BANDA-ALT-BA-VENT-AA-C/VENT CLUTCH SCHWITZER, S/COMP DE FRENOS	K081000	BANDA-ALT-BA-VENT-AA-C/VENT CLUTCH SCHWITZER, S/COMP DE FRENOS	K081000
BANDA-ALT-BA-VENT-AA-C/VENT CLUTCH SCHWITZER, S/COMP DE FRENOS	K081035	BANDA-ALT-BA-VENT-AA-C/VENT CLUTCH SCHWITZER, S/COMP DE FRENOS	K081035
BANDA-ALT-BA-VENT-AA-C/VENT CLUTCH SCHWITZER	K081223	BANDA-ALT-BA-VENT-AA-C/VENT CLUTCH SCHWITZER	K081223
BANDA-ALT-BA-VENT-AA	K081265	BANDA-ALT-BA-VENT-AA	K081265
BANDA-ALT-BA-VENT	K081124	BANDA-ALT-BA-VENT	K081124
TERMOSTATO-195°	33967	TERMOSTATO-195°	33967
2000		1997	
MANGUERA INFERIOR-TUBO A RAD.	20172	MANGUERA INFERIOR-TUBO A RAD.	20172
MANGUERA INFERIOR-MOTOR A TUBO	22671	MANGUERA INFERIOR-MOTOR A TUBO	22671
MANGUERA SUPERIOR-MOTOR A RAD.	22159	MANGUERA SUPERIOR-MOTOR A RAD.	22159
TENSOR-MOTOR	38510	TENSOR-MOTOR	38510
BANDA-ALT-BA-VENT-C/VENT CLUTCH SCHWITZER, S/COMP DE FRENOS	K080893	BANDA-ALT-BA-VENT-C/VENT CLUTCH SCHWITZER, S/COMP DE FRENOS	K080893
BANDA-ALT-BA-VENT-C/VENT CLUTCH SCHWITZER, S/COMP DE FRENOS	K080922	BANDA-ALT-BA-VENT-C/VENT CLUTCH SCHWITZER, S/COMP DE FRENOS	K080922
BANDA-ALT-BA-VENT-C/VENT CLUTCH SCHWITZER	K081102	BANDA-ALT-BA-VENT-C/VENT CLUTCH SCHWITZER	K081102
BANDA-ALT-BA-VENT-AA-C/VENT CLUTCH SCHWITZER, S/COMP DE FRENOS	K081000	BANDA-ALT-BA-VENT-AA-C/VENT CLUTCH SCHWITZER, S/COMP DE FRENOS	K081000
BANDA-ALT-BA-VENT-AA-C/VENT CLUTCH SCHWITZER, S/COMP DE FRENOS	K081035	BANDA-ALT-BA-VENT-AA-C/VENT CLUTCH SCHWITZER, S/COMP DE FRENOS	K081035
BANDA-ALT-BA-VENT-AA-C/VENT CLUTCH SCHWITZER	K081223	BANDA-ALT-BA-VENT-AA-C/VENT CLUTCH SCHWITZER	K081223
BANDA-ALT-BA-VENT-AA	K081265	BANDA-ALT-BA-VENT-AA	K081265
BANDA-ALT-BA-VENT	K081124	BANDA-ALT-BA-VENT	K081124
		TERMOSTATO-195°	33967



MASTER SERVICIO PESADO 2014

INTERNATIONAL/
NAVISTAR
4700

1996

MANGUERA INFERIOR-TUBO A RAD.	20172
MANGUERA INFERIOR-MOTOR A TUBO	22671
MANGUERA SUPERIOR-MOTOR A RAD.	22159
TENSOR-MOTOR	38510
BANDA-ALT-BA-VENT-C/VENT CLUTCH SCHWITZER, S/COMP DE FRENOS	K080893
BANDA-ALT-BA-VENT-C/VENT CLUTCH SCHWITZER, S/COMP DE FRENOS	K080922
BANDA-ALT-BA-VENT-C/VENT CLUTCH SCHWITZER	K081102
BANDA-ALT-BA-VENT-AA-C/VENT CLUTCH SCHWITZER, S/COMP DE FRENOS	K081000
BANDA-ALT-BA-VENT-AA-C/VENT CLUTCH SCHWITZER, S/COMP DE FRENOS	K081035
BANDA-ALT-BA-VENT-AA-C/VENT CLUTCH SCHWITZER	K081223
BANDA-ALT-BA-VENT-AA	K081265
BANDA-ALT-BA-VENT	K081124
TERMOSTATO-195°	33967

1995

MANGUERA INFERIOR-TUBO A RAD.	20172
MANGUERA INFERIOR-MOTOR A TUBO	22671
MANGUERA SUPERIOR-MOTOR A RAD.	22159
TENSOR-MOTOR	38510
BANDA-ALT-BA-VENT-C/VENT CLUTCH SCHWITZER, S/COMP DE FRENOS	K080893
BANDA-ALT-BA-VENT-C/VENT CLUTCH SCHWITZER, S/COMP DE FRENOS	K080922
BANDA-ALT-BA-VENT-C/VENT CLUTCH SCHWITZER	K081102
BANDA-ALT-BA-VENT-AA-C/VENT CLUTCH SCHWITZER, S/COMP DE FRENOS	K081000
BANDA-ALT-BA-VENT-AA-C/VENT CLUTCH SCHWITZER, S/COMP DE FRENOS	K081035
BANDA-ALT-BA-VENT-AA-C/VENT CLUTCH SCHWITZER	K081223
BANDA-ALT-BA-VENT-AA	K081265
BANDA-ALT-BA-VENT	K081124
TERMOSTATO-195°	33967

INTERNATIONAL/NAVISTAR DT466

2002

BANDA-VENT-AA	K060470
POLEA DEL TENSOR-VENT-AA	36091
TENSOR-VENT-AA	38512
MANGUERA INFERIOR-MOTOR A RAD.	21115
MANGUERA SUPERIOR-MOTOR A RAD.	22140
BANDA-ALT-VENT	K080726
BANDA-ALT-VENT	K080730
BANDA-ALT-VENT	K080738
BANDA-ALT-VENT	K080774
POLEA-ALT-VENT	36091
TENSOR-ALT-VENT	38514
TERMOSTATO-190°	33179
TERMOSTATO-190°	33957

TERMOSTATO-180°

33118

2001

BANDA-VENT-AA	K060470
POLEA DEL TENSOR-VENT-AA	36091
TENSOR-VENT-AA	38512
MANGUERA INFERIOR-MOTOR A RAD.	21115
MANGUERA SUPERIOR-MOTOR A RAD.	22140
BANDA-ALT-VENT	K080726
BANDA-ALT-VENT	K080730
BANDA-ALT-VENT	K080738
BANDA-ALT-VENT	K080774
POLEA-ALT-VENT	36091
TENSOR-ALT-VENT	38514
TERMOSTATO-190°	33179
TERMOSTATO-190°	33957
TERMOSTATO-180°	33118

2000

POLEA DEL TENSOR-VENT-AA	36091
TENSOR-VENT-AA	38512
MANGUERA INFERIOR-MOTOR A RAD.	21115
MANGUERA SUPERIOR-MOTOR A RAD.	22140
BANDA-ALT-VENT	K080726
BANDA-ALT-VENT	K080730
BANDA-ALT-VENT	K080738
BANDA-ALT-VENT	K080774
POLEA-ALT-VENT	36091
TENSOR-ALT-VENT	38514
BANDA-AA	K060470
TERMOSTATO-190°	33179
TERMOSTATO-190°	33957
TERMOSTATO-180°	33118

1999

BANDA-VENT-AA	K060470
POLEA DEL TENSOR-VENT-AA	36091
TENSOR-VENT-AA	38511
MANGUERA INFERIOR-TUBO A RAD.	21115
MANGUERA INFERIOR-MOTOR A TUBO	21842
MANGUERA INFERIOR-MOTOR A RAD.	21115
MANGUERA SUPERIOR-MOTOR A RAD.	21765
BANDA-ALT-VENT	K080726
BANDA-ALT-VENT	K080730
BANDA-ALT-VENT	K080738
BANDA-ALT-VENT	K080774



POLEA-ALT-VENT	36091	MANGUERA INFERIOR-TUBO A RAD.	21115
TENSOR-ALT-VENT	38514	MANGUERA INFERIOR-MOTOR A TUBO	21842
TERMOSTATO-190°	33179	MANGUERA SUPERIOR-MOTOR A RAD.	21765
TERMOSTATO-190°	33957	BANDA-ALT-VENT	K080726
TERMOSTATO-180°	33118	BANDA-ALT-VENT	K080730
1998		BANDA-ALT-VENT	K080738
BANDA-VENT-AA	K060470	BANDA-ALT-VENT	K080774
POLEA DEL TENSOR-VENT-AA	36091	POLEA-ALT-VENT	36091
TENSOR-VENT-AA	38511	TENSOR-ALT-VENT	38514
MANGUERA INFERIOR-TUBO A RAD.	21115	TERMOSTATO-190°	33179
MANGUERA INFERIOR-MOTOR A TUBO	21842	TERMOSTATO-190°	33957
MANGUERA INFERIOR-MOTOR A RAD.	21115	TERMOSTATO-180°	33118
MANGUERA SUPERIOR-MOTOR A RAD.	21765	1995	
BANDA-ALT-VENT	K080726	BANDA-VENT-AA	K060470
BANDA-ALT-VENT	K080730	POLEA DEL TENSOR-VENT-AA	36091
BANDA-ALT-VENT	K080738	TENSOR-VENT-AA	38511
BANDA-ALT-VENT	K080774	MANGUERA INFERIOR-TUBO A RAD.	21115
POLEA-ALT-VENT	36091	MANGUERA INFERIOR-MOTOR A TUBO	21842
TENSOR-ALT-VENT	38514	MANGUERA SUPERIOR-MOTOR A RAD.	21765
TERMOSTATO-190°	33179	BANDA-ALT-VENT	K080726
TERMOSTATO-190°	33957	BANDA-ALT-VENT	K080730
TERMOSTATO-180°	33118	BANDA-ALT-VENT	K080738
1997		BANDA-ALT-VENT	K080774
POLEA DEL TENSOR-VENT-AA	36091	POLEA-ALT-VENT	36091
TENSOR-VENT-AA	38511	TENSOR-ALT-VENT	38514
MANGUERA INFERIOR-TUBO A RAD.	21115	TERMOSTATO-190°	33179
MANGUERA INFERIOR-MOTOR A TUBO	21842	TERMOSTATO-190°	33957
MANGUERA INFERIOR-MOTOR A RAD.	21115	TERMOSTATO-180°	33118
MANGUERA SUPERIOR-MOTOR A RAD.	21765	INTERNATIONAL/NAVISTAR DT408 DIESEL	
BANDA-ALT-VENT	K080726	1997	
BANDA-ALT-VENT	K080730	BANDA-ALT-VENT	K080740
BANDA-ALT-VENT	K080738	BANDA-ALT-VENT	K080745
BANDA-ALT-VENT	K080774	POLEA-ALT-VENT	36091
POLEA-ALT-VENT	36091	TENSOR-ALT-VENT	38514
TENSOR-ALT-VENT	38514	BANDA-AA	K060470
BANDA-AA	K060470	TENSOR-AA	38511
TERMOSTATO-190°	33179	MANGUERA DE AGUA-	30T 3/4"
TERMOSTATO-190°	33957	MANGUERA DE CALEFACCIÓN-	35B 3/8"
TERMOSTATO-180°	33118	MANGUERA DE ENFRIAMIENTO-	CHARTER 1"
1996		MANGUERA INFERIOR-	21891
BANDA-VENT-AA	K060470	MANGUERA SUPERIOR-	22140
POLEA DEL TENSOR-VENT-AA	36091	POLEA DEL TENSOR-	36091
TENSOR-VENT-AA	38511	1995	



MASTER SERVICIO PESADO 2014

INTERNATIONAL/
NAVISTAR
4700

BANDA-ALT-VENT	K080740	BANDA-ALT-BA-VENT-AA-C/VENT CLUTCH SCHWITZER	K081223
BANDA-ALT-VENT	K080745	BANDA-ALT-BA-VENT-AA	K081265
POLEA-ALT-VENT	36091	BANDA-ALT-BA-VENT	K081124
TENSOR-ALT-VENT	38514	TERMOSTATO-195°	33967
BANDA-AA	K060470	1996	
TENSOR-AA	38511	MANGUERA INFERIOR-TUBO A RAD.	20172
MANGUERA DE AGUA-	30T 3/4"	MANGUERA INFERIOR-MOTOR A TUBO	22671
MANGUERA DE CALEFACCIÓN-	35B 3/8"	MANGUERA SUPERIOR-MOTOR A RAD.	22159
MANGUERA DE ENFRIAMIENTO-	CHARTER 1"	TENSOR-MOTOR	38510
MANGUERA INFERIOR-	21891	BANDA-ALT-BA-VENT-C/VENT CLUTCH SCHWITZER, S/COMP DE FRENOS	K080893
MANGUERA SUPERIOR-	22140	BANDA-ALT-BA-VENT-C/VENT CLUTCH SCHWITZER, S/COMP DE FRENOS	K080922
POLEA DEL TENSOR-	36091	BANDA-ALT-BA-VENT-C/VENT CLUTCH SCHWITZER	K081102
INTERNATIONAL/NAVISTAR 530 DIESEL		BANDA-ALT-BA-VENT-AA-C/VENT CLUTCH SCHWITZER, S/COMP DE FRENOS	K081000
2002		BANDA-ALT-BA-VENT-AA-C/VENT CLUTCH SCHWITZER, S/COMP DE FRENOS	K081035
BANDA-VENT-AA	K060470	BANDA-ALT-BA-VENT-AA-C/VENT CLUTCH SCHWITZER	K081223
POLEA DEL TENSOR-VENT-AA	36091	BANDA-ALT-BA-VENT-AA	K081265
TENSOR-VENT-AA	38512	BANDA-ALT-BA-VENT	K081124
BANDA-TOMA DE FUERZA-ALT-VENT	K080716	TERMOSTATO-195°	33967
POLEA DEL TENSOR-TOMA DE FUERZA-ALT-VENT	36091	1995	
TENSOR-TOMA DE FUERZA-ALT-VENT	38514	MANGUERA INFERIOR-TUBO A RAD.	20172
MANGUERA INFERIOR-MOTOR A RAD.	21115	MANGUERA INFERIOR-MOTOR A TUBO	22671
MANGUERA SUPERIOR-MOTOR A RAD.	22140	MANGUERA SUPERIOR-MOTOR A RAD.	22159
1999		TENSOR-MOTOR	38510
BANDA-VENT-AA	K060470	BANDA-ALT-BA-VENT-C/VENT CLUTCH SCHWITZER, S/COMP DE FRENOS	K080893
POLEA DEL TENSOR-VENT-AA	36091	BANDA-ALT-BA-VENT-C/VENT CLUTCH SCHWITZER, S/COMP DE FRENOS	K080922
TENSOR-VENT-AA	38512	BANDA-ALT-BA-VENT-C/VENT CLUTCH SCHWITZER	K081102
BANDA-TOMA DE FUERZA-ALT-VENT	K080716	BANDA-ALT-BA-VENT-AA-C/VENT CLUTCH SCHWITZER, S/COMP DE FRENOS	K081000
POLEA DEL TENSOR-TOMA DE FUERZA-ALT-VENT	36091	BANDA-ALT-BA-VENT-AA-C/VENT CLUTCH SCHWITZER, S/COMP DE FRENOS	K081035
TENSOR-TOMA DE FUERZA-ALT-VENT	38514	BANDA-ALT-BA-VENT-AA-C/VENT CLUTCH SCHWITZER	K081223
MANGUERA INFERIOR-MOTOR A RAD.	21115	BANDA-ALT-BA-VENT-AA	K081265
MANGUERA SUPERIOR-MOTOR A RAD.	22140	BANDA-ALT-BA-VENT	K081124
		TERMOSTATO-195°	33967
4800		INTERNATIONAL/NAVISTAR DT466	
INTERNATIONAL/NAVISTAR T444 DIESEL		2003	
1997		POLEA DEL TENSOR-VENT-AA	36091
MANGUERA INFERIOR-TUBO A RAD.	20172	TENSOR-VENT-AA	38511
MANGUERA INFERIOR-MOTOR A TUBO	22671	MANGUERA INFERIOR-TUBO A RAD.	21115
MANGUERA SUPERIOR-MOTOR A RAD.	22159	MANGUERA INFERIOR-MOTOR A TUBO	21842
TENSOR-MOTOR	38510	MANGUERA INFERIOR-MOTOR A RAD.	21842
BANDA-ALT-BA-VENT-C/VENT CLUTCH SCHWITZER, S/COMP DE FRENOS	K080893	MANGUERA SUPERIOR-MOTOR A RAD.	21765
BANDA-ALT-BA-VENT-C/VENT CLUTCH SCHWITZER, S/COMP DE FRENOS	K080922	BANDA-ALT-VENT	K080726
BANDA-ALT-BA-VENT-C/VENT CLUTCH SCHWITZER	K081102	BANDA-ALT-VENT	K080730
BANDA-ALT-BA-VENT-AA-C/VENT CLUTCH SCHWITZER, S/COMP DE FRENOS	K081000	BANDA-ALT-VENT	K080738
BANDA-ALT-BA-VENT-AA-C/VENT CLUTCH SCHWITZER, S/COMP DE FRENOS	K081035		



MASTER SERVICIO PESADO 2014

INTERNATIONAL/
NAVISTAR
4800

BANDA-ALT-VENT	K080774	POLEA DEL TENSOR-VENT-AA	36091
POLEA-ALT-VENT	36091	TENSOR-VENT-AA	38511
TENSOR-ALT-VENT	38514	MANGUERA INFERIOR-TUBO A RAD.	21115
BANDA-AA	K060470	MANGUERA INFERIOR-MOTOR A TUBO	21842
TERMOSTATO-190°	33179	MANGUERA INFERIOR-MOTOR A RAD.	21842
TERMOSTATO-190°	33957	MANGUERA SUPERIOR-MOTOR A RAD.	21765
TERMOSTATO-180°	33118	BANDA-ALT-VENT	K080726
2002		BANDA-ALT-VENT	K080730
BANDA-VENT-AA	K060470	BANDA-ALT-VENT	K080738
POLEA DEL TENSOR-VENT-AA	36091	BANDA-ALT-VENT	K080774
TENSOR-VENT-AA	38511	POLEA-ALT-VENT	36091
MANGUERA INFERIOR-TUBO A RAD.	21115	TENSOR-ALT-VENT	38514
MANGUERA INFERIOR-MOTOR A TUBO	21842	TERMOSTATO-190°	33179
MANGUERA INFERIOR-MOTOR A RAD.	21842	TERMOSTATO-190°	33957
MANGUERA SUPERIOR-MOTOR A RAD.	21765	TERMOSTATO-180°	33118
BANDA-ALT-VENT	K080726	1999	
BANDA-ALT-VENT	K080730	BANDA-VENT-AA	K060470
BANDA-ALT-VENT	K080738	POLEA DEL TENSOR-VENT-AA	36091
BANDA-ALT-VENT	K080774	TENSOR-VENT-AA	38511
POLEA-ALT-VENT	36091	MANGUERA INFERIOR-TUBO A RAD.	21115
TENSOR-ALT-VENT	38514	MANGUERA INFERIOR-MOTOR A TUBO	21842
TERMOSTATO-190°	33179	MANGUERA INFERIOR-MOTOR A RAD.	21115
TERMOSTATO-190°	33957	MANGUERA SUPERIOR-MOTOR A RAD.	21765
TERMOSTATO-180°	33118	BANDA-ALT-VENT	K080726
2001		BANDA-ALT-VENT	K080730
BANDA-VENT-AA	K060470	BANDA-ALT-VENT	K080738
POLEA DEL TENSOR-VENT-AA	36091	BANDA-ALT-VENT	K080774
TENSOR-VENT-AA	38511	POLEA-ALT-VENT	36091
MANGUERA INFERIOR-TUBO A RAD.	21115	TENSOR-ALT-VENT	38514
MANGUERA INFERIOR-MOTOR A TUBO	21842	TERMOSTATO-190°	33179
MANGUERA INFERIOR-MOTOR A RAD.	21842	TERMOSTATO-190°	33957
MANGUERA SUPERIOR-MOTOR A RAD.	21765	TERMOSTATO-180°	33118
BANDA-ALT-VENT	K080726	1998	
BANDA-ALT-VENT	K080730	BANDA-VENT-AA	K060470
BANDA-ALT-VENT	K080738	POLEA DEL TENSOR-VENT-AA	36091
BANDA-ALT-VENT	K080774	TENSOR-VENT-AA	38511
POLEA-ALT-VENT	36091	MANGUERA INFERIOR-TUBO A RAD.	21115
TENSOR-ALT-VENT	38514	MANGUERA INFERIOR-MOTOR A TUBO	21842
TERMOSTATO-190°	33179	MANGUERA INFERIOR-MOTOR A RAD.	21115
TERMOSTATO-190°	33957	MANGUERA SUPERIOR-MOTOR A RAD.	21765
TERMOSTATO-180°	33118	BANDA-ALT-VENT	K080726
2000		BANDA-ALT-VENT	K080730
BANDA-VENT-AA	K060470		



MASTER SERVICIO PESADO 2014

INTERNATIONAL/
NAVISTAR
4800

BANDA-ALT-VENT	K080738	POLEA DEL TENSOR-VENT-AA	36091
BANDA-ALT-VENT	K080774	TENSOR-VENT-AA	38511
POLEA-ALT-VENT	36091	MANGUERA INFERIOR-TUBO A RAD.	21115
TENSOR-ALT-VENT	38514	MANGUERA INFERIOR-MOTOR A TUBO	21842
TERMOSTATO-190°	33179	MANGUERA INFERIOR-MOTOR A RAD.	21842
TERMOSTATO-190°	33957	MANGUERA SUPERIOR-MOTOR A RAD.	21765
TERMOSTATO-180°	33118	BANDA-ALT-VENT	K080726
1997		BANDA-ALT-VENT	K080730
POLEA DEL TENSOR-VENT-AA	36091	BANDA-ALT-VENT	K080738
TENSOR-VENT-AA	38511	BANDA-ALT-VENT	K080774
MANGUERA INFERIOR-TUBO A RAD.	21115	POLEA-ALT-VENT	36091
MANGUERA INFERIOR-MOTOR A TUBO	21842	TENSOR-ALT-VENT	38514
MANGUERA INFERIOR-MOTOR A RAD.	21115	TERMOSTATO-190°	33179
MANGUERA SUPERIOR-MOTOR A RAD.	21765	TERMOSTATO-190°	33957
BANDA-ALT-VENT	K080726	TERMOSTATO-180°	33118
BANDA-ALT-VENT	K080730	INTERNATIONAL/NAVISTAR DT408 DIESEL	
BANDA-ALT-VENT	K080738	1997	
BANDA-ALT-VENT	K080774	BANDA-ALT-VENT	K080740
POLEA-ALT-VENT	36091	BANDA-ALT-VENT	K080745
TENSOR-ALT-VENT	38514	POLEA-ALT-VENT	36091
BANDA-AA	K060470	TENSOR-ALT-VENT	38514
TERMOSTATO-190°	33179	BANDA-AA	K060470
TERMOSTATO-190°	33957	TENSOR-AA	38511
TERMOSTATO-180°	33118	MANGUERA DE AGUA-	30T 3/4"
1996		MANGUERA DE CALEFACCIÓN-	35B 3/8"
BANDA-VENT-AA	K060470	MANGUERA DE ENFRIAMIENTO-	CHARTER 1"
POLEA DEL TENSOR-VENT-AA	36091	MANGUERA INFERIOR-	21891
TENSOR-VENT-AA	38511	MANGUERA SUPERIOR-	22140
MANGUERA INFERIOR-TUBO A RAD.	21115	POLEA DEL TENSOR-	36091
MANGUERA INFERIOR-MOTOR A TUBO	21842	1995	
MANGUERA INFERIOR-MOTOR A RAD.	21842	BANDA-ALT-VENT	K080740
MANGUERA SUPERIOR-MOTOR A RAD.	21765	BANDA-ALT-VENT	K080745
BANDA-ALT-VENT	K080726	POLEA-ALT-VENT	36091
BANDA-ALT-VENT	K080730	TENSOR-ALT-VENT	38514
BANDA-ALT-VENT	K080738	BANDA-AA	K060470
BANDA-ALT-VENT	K080774	TENSOR-AA	38511
POLEA-ALT-VENT	36091	MANGUERA DE AGUA-	30T 3/4"
TENSOR-ALT-VENT	38514	MANGUERA DE CALEFACCIÓN-	35B 3/8"
TERMOSTATO-190°	33179	MANGUERA DE ENFRIAMIENTO-	CHARTER 1"
TERMOSTATO-190°	33957	MANGUERA INFERIOR-	21891
TERMOSTATO-180°	33118	MANGUERA SUPERIOR-	22140
1995		POLEA DEL TENSOR-	36091
BANDA-VENT-AA	K060470	INTERNATIONAL/NAVISTAR 530 DIESEL	



2002

BANDA-VENT-AA	K060470
POLEA DEL TENSOR-VENT-AA	36091
TENSOR-VENT-AA	38512
BANDA-TOMA DE FUERZA-ALT-VENT	K080716
POLEA DEL TENSOR-TOMA DE FUERZA-ALT-VENT	36091
TENSOR-TOMA DE FUERZA-ALT-VENT	38514
MANGUERA INFERIOR-MOTOR A RAD.	21115
MANGUERA SUPERIOR-MOTOR A RAD.	22140

TENSOR-MOTOR	38510
BANDA-ALT-BA-VENT-C/VENT CLUTCH SCHWITZER, S/COMP DE FRENOS	K080893
BANDA-ALT-BA-VENT-C/VENT CLUTCH SCHWITZER, S/COMP DE FRENOS	K080922
BANDA-ALT-BA-VENT-C/VENT CLUTCH SCHWITZER	K081102
BANDA-ALT-BA-VENT-AA-C/VENT CLUTCH SCHWITZER, S/COMP DE FRENOS	K081000
BANDA-ALT-BA-VENT-AA-C/VENT CLUTCH SCHWITZER, S/COMP DE FRENOS	K081035
BANDA-ALT-BA-VENT-AA-C/VENT CLUTCH SCHWITZER	K081223
BANDA-ALT-BA-VENT-AA	K081265
BANDA-ALT-BA-VENT	K081124
TERMOSTATO-195°	33967

4900

INTERNATIONAL/NAVISTAR T444 DIESEL

1997

MANGUERA INFERIOR-TUBO A RAD.	20172
MANGUERA INFERIOR-MOTOR A TUBO	22671
MANGUERA SUPERIOR-MOTOR A RAD.	22159
TENSOR-MOTOR	38510
BANDA-ALT-BA-VENT-C/VENT CLUTCH SCHWITZER, S/COMP DE FRENOS	K080893
BANDA-ALT-BA-VENT-C/VENT CLUTCH SCHWITZER, S/COMP DE FRENOS	K080922
BANDA-ALT-BA-VENT-C/VENT CLUTCH SCHWITZER	K081102
BANDA-ALT-BA-VENT-AA-C/VENT CLUTCH SCHWITZER, S/COMP DE FRENOS	K081000
BANDA-ALT-BA-VENT-AA-C/VENT CLUTCH SCHWITZER, S/COMP DE FRENOS	K081035
BANDA-ALT-BA-VENT-AA-C/VENT CLUTCH SCHWITZER	K081223
BANDA-ALT-BA-VENT-AA	K081265
BANDA-ALT-BA-VENT	K081124
TERMOSTATO-195°	33967

INTERNATIONAL/NAVISTAR DT530E

2001

TENSOR-VENT-AA	38512
TENSOR-VENT-AA	38514

INTERNATIONAL/NAVISTAR DT466

2003

TERMOSTATO-190°	33179
TERMOSTATO-190°	33957
TERMOSTATO-180°	33118

2002

BANDA-VENT-AA	K060470
POLEA DEL TENSOR-VENT-AA	36091
TENSOR-VENT-AA	38512
MANGUERA INFERIOR-MOTOR A RAD.	21891
BANDA-ALT-VENT	K080726
BANDA-ALT-VENT	K080730
BANDA-ALT-VENT	K080738
BANDA-ALT-VENT	K080774
POLEA-ALT-VENT	36091
TENSOR-ALT-VENT	38514
TERMOSTATO-190°	33179
TERMOSTATO-190°	33957
TERMOSTATO-180°	33118

2001

BANDA-VENT-AA	K060470
POLEA DEL TENSOR-VENT-AA	36091
TENSOR-VENT-AA	38512
MANGUERA INFERIOR-MOTOR A RAD.	21115
MANGUERA SUPERIOR-MOTOR A RAD.	22140
BANDA-ALT-VENT	K080726
BANDA-ALT-VENT	K080730
BANDA-ALT-VENT	K080738
BANDA-ALT-VENT	K080774

1996

MANGUERA INFERIOR-TUBO A RAD.	20172
MANGUERA INFERIOR-MOTOR A TUBO	22671
MANGUERA SUPERIOR-MOTOR A RAD.	22159
TENSOR-MOTOR	38510
BANDA-ALT-BA-VENT-C/VENT CLUTCH SCHWITZER, S/COMP DE FRENOS	K080893
BANDA-ALT-BA-VENT-C/VENT CLUTCH SCHWITZER, S/COMP DE FRENOS	K080922
BANDA-ALT-BA-VENT-C/VENT CLUTCH SCHWITZER	K081102
BANDA-ALT-BA-VENT-AA-C/VENT CLUTCH SCHWITZER, S/COMP DE FRENOS	K081000
BANDA-ALT-BA-VENT-AA-C/VENT CLUTCH SCHWITZER, S/COMP DE FRENOS	K081035
BANDA-ALT-BA-VENT-AA-C/VENT CLUTCH SCHWITZER	K081223
BANDA-ALT-BA-VENT-AA	K081265
BANDA-ALT-BA-VENT	K081124
TERMOSTATO-195°	33967

1995

MANGUERA INFERIOR-TUBO A RAD.	20172
MANGUERA INFERIOR-MOTOR A TUBO	22671
MANGUERA SUPERIOR-MOTOR A RAD.	22159



MASTER SERVICIO PESADO 2014

INTERNATIONAL/
NAVISTAR
4900

POLEA-ALT-VENT	36091	MANGUERA INFERIOR-MOTOR A RAD.	21115
TENSOR-ALT-VENT	38514	MANGUERA SUPERIOR-MOTOR A RAD.	21765
TERMOSTATO-190°	33179	BANDA-ALT-VENT	K080726
TERMOSTATO-190°	33957	BANDA-ALT-VENT	K080730
TERMOSTATO-180°	33118	BANDA-ALT-VENT	K080738
2000		BANDA-ALT-VENT	K080774
BANDA-VENT-AA	K060470	POLEA-ALT-VENT	36091
POLEA DEL TENSOR-VENT-AA	36091	TENSOR-ALT-VENT	38514
TENSOR-VENT-AA	38512	TERMOSTATO-190°	33179
MANGUERA INFERIOR-MOTOR A RAD.	21115	TERMOSTATO-190°	33957
MANGUERA SUPERIOR-MOTOR A RAD.	22140	TERMOSTATO-180°	33118
BANDA-ALT-VENT	K080726	1997	
BANDA-ALT-VENT	K080730	POLEA DEL TENSOR-VENT-AA	36091
BANDA-ALT-VENT	K080738	TENSOR-VENT-AA	38511
BANDA-ALT-VENT	K080774	MANGUERA INFERIOR-TUBO A RAD.	21115
POLEA-ALT-VENT	36091	MANGUERA INFERIOR-MOTOR A TUBO	21842
TENSOR-ALT-VENT	38514	MANGUERA INFERIOR-MOTOR A RAD.	21115
TERMOSTATO-190°	33179	MANGUERA SUPERIOR-MOTOR A RAD.	21765
TERMOSTATO-190°	33957	BANDA-ALT-VENT	K080726
TERMOSTATO-180°	33118	BANDA-ALT-VENT	K080730
1999		BANDA-ALT-VENT	K080738
BANDA-VENT-AA	K060470	BANDA-ALT-VENT	K080774
POLEA DEL TENSOR-VENT-AA	36091	POLEA-ALT-VENT	36091
TENSOR-VENT-AA	38511	TENSOR-ALT-VENT	38514
MANGUERA INFERIOR-TUBO A RAD.	21115	BANDA-AA	K060470
MANGUERA INFERIOR-MOTOR A TUBO	21842	TERMOSTATO-190°	33179
MANGUERA INFERIOR-MOTOR A RAD.	21115	TERMOSTATO-190°	33957
MANGUERA SUPERIOR-MOTOR A RAD.	21765	TERMOSTATO-180°	33118
BANDA-ALT-VENT	K080726	1996	
BANDA-ALT-VENT	K080730	BANDA-VENT-AA	K060470
BANDA-ALT-VENT	K080738	POLEA DEL TENSOR-VENT-AA	36091
BANDA-ALT-VENT	K080774	TENSOR-VENT-AA	38511
POLEA-ALT-VENT	36091	MANGUERA INFERIOR-TUBO A RAD.	21115
TENSOR-ALT-VENT	38514	MANGUERA INFERIOR-MOTOR A TUBO	21842
TERMOSTATO-190°	33179	MANGUERA INFERIOR-MOTOR A RAD.	21842
TERMOSTATO-190°	33957	MANGUERA SUPERIOR-MOTOR A RAD.	21765
TERMOSTATO-180°	33118	BANDA-ALT-VENT	K080726
1998		BANDA-ALT-VENT	K080730
BANDA-VENT-AA	K060470	BANDA-ALT-VENT	K080738
POLEA DEL TENSOR-VENT-AA	36091	BANDA-ALT-VENT	K080774
TENSOR-VENT-AA	38511	POLEA-ALT-VENT	36091
MANGUERA INFERIOR-TUBO A RAD.	21115	TENSOR-ALT-VENT	38514
MANGUERA INFERIOR-MOTOR A TUBO	21842		



TERMOSTATO-190°	33179	MANGUERA DE ENFRIAMIENTO-	CHARTER 1"
TERMOSTATO-190°	33957	MANGUERA INFERIOR-	21891
TERMOSTATO-180°	33118	MANGUERA SUPERIOR-	22140
1995		POLEA DEL TENSOR-	36091
BANDA-VENT-AA	K060470	INTERNATIONAL/NAVISTAR 530 DIESEL	
POLEA DEL TENSOR-VENT-AA	36091	2002	
TENSOR-VENT-AA	38511	BANDA-VENT-AA	K060470
MANGUERA INFERIOR-TUBO A RAD.	21115	POLEA DEL TENSOR-VENT-AA	36091
MANGUERA INFERIOR-MOTOR A TUBO	21842	TENSOR-VENT-AA	38512
MANGUERA INFERIOR-MOTOR A RAD.	21842	BANDA-TOMA DE FUERZA-ALT-VENT	K080716
MANGUERA SUPERIOR-MOTOR A RAD.	21765	POLEA DEL TENSOR-TOMA DE FUERZA-ALT-VENT	36091
BANDA-ALT-VENT	K080726	TENSOR-TOMA DE FUERZA-ALT-VENT	38514
BANDA-ALT-VENT	K080730	MANGUERA INFERIOR-MOTOR A RAD.	21115
BANDA-ALT-VENT	K080738	MANGUERA SUPERIOR-MOTOR A RAD.	22140
BANDA-ALT-VENT	K080774	2001	
POLEA-ALT-VENT	36091	BANDA-VENT-AA	K060470
TENSOR-ALT-VENT	38514	POLEA DEL TENSOR-VENT-AA	36091
TERMOSTATO-190°	33179	TENSOR-VENT-AA	38512
TERMOSTATO-190°	33957	BANDA-TOMA DE FUERZA-ALT-VENT	K080716
TERMOSTATO-180°	33118	POLEA DEL TENSOR-TOMA DE FUERZA-ALT-VENT	36091
INTERNATIONAL/NAVISTAR DT408 DIESEL		TENSOR-TOMA DE FUERZA-ALT-VENT	38514
1997		MANGUERA INFERIOR-MOTOR A RAD.	21115
BANDA-ALT-VENT	K080740	MANGUERA SUPERIOR-MOTOR A RAD.	22140
BANDA-ALT-VENT	K080745	2000	
POLEA-ALT-VENT	36091	BANDA-VENT-AA	K060470
TENSOR-ALT-VENT	38514	POLEA DEL TENSOR-VENT-AA	36091
BANDA-AA	K060470	TENSOR-VENT-AA	38512
TENSOR-AA	38511	BANDA-TOMA DE FUERZA-ALT-VENT	K080716
MANGUERA DE AGUA-	30T 3/4"	POLEA DEL TENSOR-TOMA DE FUERZA-ALT-VENT	36091
MANGUERA DE CALEFACCIÓN-	35B 3/8"	TENSOR-TOMA DE FUERZA-ALT-VENT	38514
MANGUERA DE ENFRIAMIENTO-	CHARTER 1"	MANGUERA INFERIOR-MOTOR A RAD.	21115
MANGUERA INFERIOR-	21891	MANGUERA SUPERIOR-MOTOR A RAD.	22140
MANGUERA SUPERIOR-	22140	1999	
POLEA DEL TENSOR-	36091	BANDA-VENT-AA	K060470
1995		POLEA DEL TENSOR-VENT-AA	36091
BANDA-ALT-VENT	K080740	TENSOR-VENT-AA	38512
BANDA-ALT-VENT	K080745	BANDA-TOMA DE FUERZA-ALT-VENT	K080716
POLEA-ALT-VENT	36091	POLEA DEL TENSOR-TOMA DE FUERZA-ALT-VENT	36091
TENSOR-ALT-VENT	38514	TENSOR-TOMA DE FUERZA-ALT-VENT	38514
BANDA-AA	K060470	MANGUERA INFERIOR-MOTOR A RAD.	21115
TENSOR-AA	38511	MANGUERA SUPERIOR-MOTOR A RAD.	22140
MANGUERA DE AGUA-	30T 3/4"	1998	
MANGUERA DE CALEFACCIÓN-	35B 3/8"	BANDA-VENT-AA	K060470



MASTER SERVICIO PESADO 2014

INTERNATIONAL/
NAVISTAR
4900

POLEA DEL TENSOR-VENT-AA	36091	BANDA-TOMA DE FUERZA-VENT	PQ28522
TENSOR-VENT-AA	38512	BANDA-TOMA DE FUERZA-BA	K060408
BANDA-TOMA DE FUERZA-ALT-VENT	K080716	BANDA-TOMA DE FUERZA-AA	8405 GS
POLEA DEL TENSOR-TOMA DE FUERZA-ALT-VENT	36091	MANGUERA SUPERIOR-MOTOR A TUBO	CHARTER 2 1/4"
TENSOR-TOMA DE FUERZA-ALT-VENT	38514	BANDA-ALT	PQ17450
MANGUERA INFERIOR-MOTOR A RAD.	21115	MANGUERA INFERIOR-	CHARTER 2 1/4"
MANGUERA SUPERIOR-MOTOR A RAD.	22140	1999	
1997		MANGUERA INFERIOR-TUBO A RAD.	20748
BANDA-VENT-AA	K060470	MANGUERA INFERIOR-TUBO A RAD.	24436
POLEA DEL TENSOR-VENT-AA	36091	MANGUERA SUPERIOR-TUBO A RAD.	20748
TENSOR-VENT-AA	38512	BANDA-TOMA DE FUERZA-VENT	PQ28522
BANDA-TOMA DE FUERZA-ALT-VENT	K080716	BANDA-TOMA DE FUERZA-VENT	TR28522
POLEA DEL TENSOR-TOMA DE FUERZA-ALT-VENT	36091	BANDA-TOMA DE FUERZA-BA	K060408
TENSOR-TOMA DE FUERZA-ALT-VENT	38514	MANGUERA INFERIOR-MOTOR A TUBO	24436
MANGUERA INFERIOR-MOTOR A RAD.	21115	MANGUERA SUPERIOR-MOTOR A TUBO	24436
MANGUERA SUPERIOR-MOTOR A RAD.	22140	MANGUERA SUPERIOR-MOTOR A TUBO	CHARTER 2 1/4"
1996		BANDA-ALT	9447
BANDA-VENT-AA	K060470	BANDA-ALT	PQ17450
POLEA DEL TENSOR-VENT-AA	36091	TERMOSTATO-190°	33579
TENSOR-VENT-AA	38512	TERMOSTATO-180°	33576
BANDA-TOMA DE FUERZA-ALT-VENT	K080716	TERMOSTATO-180°	33578
POLEA DEL TENSOR-TOMA DE FUERZA-ALT-VENT	36091	TERMOSTATO-170°	33577
TENSOR-TOMA DE FUERZA-ALT-VENT	38514	MANGUERA INFERIOR-	CHARTER 2 1/4"
MANGUERA INFERIOR-MOTOR A RAD.	21115	1998	
MANGUERA SUPERIOR-MOTOR A RAD.	22140	BANDA-VENT	PQ28522
1995		BANDA-VENT	TR28522
BANDA-VENT-AA	K060470	MANGUERA SILICÓN-TUBO A RAD.	SIH250363C
POLEA DEL TENSOR-VENT-AA	36091	MANGUERA SILICÓN-MOTOR A TUBO	SIH250363C
TENSOR-VENT-AA	38512	MANGUERA SUPERIOR-MOTOR A TUBO	CHARTER 2 1/2"
BANDA-TOMA DE FUERZA-ALT-VENT	K080716	BANDA-BA	K060425
POLEA DEL TENSOR-TOMA DE FUERZA-ALT-VENT	36091	BANDA-BA	K060435
TENSOR-TOMA DE FUERZA-ALT-VENT	38514	BANDA-ALT	2/9447PB
MANGUERA INFERIOR-MOTOR A RAD.	21115	BANDA-AA	PQ17430
MANGUERA SUPERIOR-MOTOR A RAD.	22140	TERMOSTATO-190°	33579
5000		TERMOSTATO-180°	33576
INTERNATIONAL/NAVISTAR 530 DIESEL		TERMOSTATO-180°	33578
1995		TERMOSTATO-170°	33577
MANGUERA SILICÓN-TUBO A RAD.	SIH250363C	BANDA-	9430
MANGUERA SILICÓN-MOTOR A TUBO	SIH250363C	MANGUERA INFERIOR-	CHARTER 2 1/2"
MANGUERA SUPERIOR-MOTOR A TUBO	24436	1997	
CUMMINS N14 DIESEL		BANDA-VENT	PQ28522
2000		BANDA-VENT	TR28522
MANGUERA INFERIOR-TUBO A RAD.	20748	MANGUERA SILICÓN-TUBO A RAD.	SIH250363C



MASTER SERVICIO PESADO 2014

INTERNATIONAL/
NAVISTAR
5000

MANGUERA SILICÓN-MOTOR A TUBO	SIH250363C	BANDA-	9430
MANGUERA SUPERIOR-MOTOR A TUBO	CHARTER 2 1/2"	MANGUERA INFERIOR-	CHARTER 2 1/2"
BANDA-BA	K060425	1994	
BANDA-BA	K060435	BANDA-VENT	PQ28522
BANDA-ALT	2/9447PB	MANGUERA SUPERIOR-MOTOR A TUBO	CHARTER 2 1/2"
BANDA-AA	PQ17430	BANDA-BA	K060425
TERMOSTATO-190°	33579	BANDA-BA	K060435
TERMOSTATO-180°	33576	BANDA-ALT	2/9447PB
TERMOSTATO-180°	33578	BANDA-AA	PQ17430
TERMOSTATO-170°	33577	MANGUERA INFERIOR-	CHARTER 2 1/2"
BANDA-	9430	1993	
MANGUERA INFERIOR-	CHARTER 2 1/2"	BANDA-VENT	2/TR28492PB
1996		BANDA-VENT	PQ28423
BANDA-VENT	PQ28522	BANDA-VENT	PQ28492
BANDA-VENT	TR28522	BANDA-VENT	PQ28514
MANGUERA SILICÓN-TUBO A RAD.	SIH250363C	BANDA-VENT	TR24530
MANGUERA SILICÓN-MOTOR A TUBO	SIH250363C	MANGUERA SUPERIOR-TUBO A RAD.	CHARTER 2 1/2"
MANGUERA SUPERIOR-MOTOR A TUBO	CHARTER 2 1/2"	MANGUERA SUPERIOR-MOTOR A TUBO	CHARTER 2 1/4"
BANDA-BA	K060425	BANDA-BA	K040430
BANDA-BA	K060435	BANDA-BA	K040445
BANDA-ALT	2/9447PB	BANDA-BA	K060435
BANDA-AA	PQ17430	BANDA-ALT	2/9447PB
TERMOSTATO-190°	33579	BANDA-ALT	PQ17450
TERMOSTATO-180°	33576	BANDA-AA	8395 GS
TERMOSTATO-180°	33578	BANDA-AA	PQ17430
TERMOSTATO-170°	33577	MANGUERA DE PASO-	CHARTER 1"
BANDA-	9430	MANGUERA INFERIOR-	CHARTER 2 1/2"
MANGUERA INFERIOR-	CHARTER 2 1/2"	1992	
1995		BANDA-VENT	2/TR28492PB
BANDA-VENT	PQ28522	BANDA-VENT	PQ28423
BANDA-VENT	TR28522	BANDA-VENT	PQ28492
MANGUERA SILICÓN-TUBO A RAD.	SIH250363C	BANDA-VENT	PQ28514
MANGUERA SILICÓN-MOTOR A TUBO	SIH250363C	BANDA-VENT	TR24530
MANGUERA SUPERIOR-MOTOR A TUBO	CHARTER 2 1/2"	MANGUERA SUPERIOR-TUBO A RAD.	CHARTER 2 1/2"
BANDA-BA	K060425	MANGUERA SUPERIOR-MOTOR A TUBO	CHARTER 2 1/4"
BANDA-BA	K060435	BANDA-BA	K040430
BANDA-ALT	2/9447PB	BANDA-BA	K040445
BANDA-AA	PQ17430	BANDA-BA	K060435
TERMOSTATO-190°	33579	BANDA-ALT	2/9447PB
TERMOSTATO-180°	33576	BANDA-ALT	PQ17450
TERMOSTATO-180°	33578	BANDA-AA	8395 GS
TERMOSTATO-170°	33577	BANDA-AA	PQ17430
		MANGUERA DE PASO-	CHARTER 1"



MASTER SERVICIO PESADO 2014

INTERNATIONAL/
NAVISTAR
5000

MANGUERA INFERIOR-	CHARTER 2 1/2"	BANDA-AA	TR22525
CUMMINS M11 DIESEL		TERMOSTATO-190°	33579
2000		TERMOSTATO-180°	33576
BANDA-VENT	K080645	TERMOSTATO-180°	33578
MANGUERA INFERIOR-TUBO A RAD.	20748	TERMOSTATO-170°	33577
BANDA-TOMA DE FUERZA-ALT	K050336	BANDA-	TR22525
BANDA-TOMA DE FUERZA-AA	TR22525	MANGUERA INFERIOR-	CHARTER 2 1/2"
MANGUERA SUPERIOR-MOTOR A TUBO	CHARTER 2 1/4"	1995	
MANGUERA INFERIOR-	CHARTER 2 1/4"	TERMOSTATO-190°	33579
1999		TERMOSTATO-180°	33576
BANDA-VENT	K080605	TERMOSTATO-180°	33578
MANGUERA INFERIOR-TUBO A RAD.	21135	TERMOSTATO-170°	33577
BANDA-TOMA DE FUERZA-ALT	K050336	CUMMINS L10 DIESEL	
MANGUERA SUPERIOR-MOTOR A TUBO	CHARTER 2 1/2"	1998	
MANGUERA INFERIOR-	CHARTER 2 1/2"	BANDA-VENT	K080605
1998		MANGUERA SILICÓN-TUBO A RAD.	SIH250363C
BANDA-VENT	K080605	MANGUERA SUPERIOR-TUBO A RAD.	24436
MANGUERA SUPERIOR-TUBO A RAD.	CHARTER 2 1/2"	MANGUERA SILICÓN-MOTOR A TUBO	SIH250363C
MANGUERA SUPERIOR-MOTOR A TUBO	CHARTER 2 1/2"	MANGUERA SUPERIOR-MOTOR A TUBO	24436
BANDA-ALT	K050336	BANDA-ALT	K050336
BANDA-AA	TR22525	TERMOSTATO-190°	33579
MANGUERA INFERIOR-	CHARTER 2 1/2"	TERMOSTATO-180°	33576
1997		TERMOSTATO-180°	33578
BANDA-VENT	K080605	TERMOSTATO-175°	33960
MANGUERA SILICÓN-TUBO A RAD.	SIH250363C	TERMOSTATO-170°	33577
MANGUERA SUPERIOR-TUBO A RAD.	CHARTER 2 1/2"	1997	
MANGUERA SILICÓN-MOTOR A TUBO	SIH250363C	BANDA-VENT	K080605
MANGUERA SUPERIOR-MOTOR A TUBO	CHARTER 2 1/2"	MANGUERA SILICÓN-TUBO A RAD.	SIH250363C
BANDA-ALT	K050336	MANGUERA SUPERIOR-TUBO A RAD.	24436
BANDA-AA	TR22525	MANGUERA SUPERIOR-TUBO A RAD.	CHARTER 2 1/4"
TERMOSTATO-190°	33579	MANGUERA SILICÓN-MOTOR A TUBO	SIH250363C
TERMOSTATO-180°	33576	MANGUERA SUPERIOR-MOTOR A TUBO	24436
TERMOSTATO-180°	33578	MANGUERA SUPERIOR-MOTOR A TUBO	CHARTER 2 1/4"
TERMOSTATO-170°	33577	BANDA-ALT	K050336
BANDA-	TR22525	TERMOSTATO-190°	33579
MANGUERA INFERIOR-	CHARTER 2 1/2"	TERMOSTATO-180°	33576
1996		TERMOSTATO-180°	33578
BANDA-VENT	K080605	TERMOSTATO-175°	33960
MANGUERA SILICÓN-TUBO A RAD.	SIH250363C	TERMOSTATO-170°	33577
MANGUERA SUPERIOR-TUBO A RAD.	CHARTER 2 1/2"	MANGUERA INFERIOR-	CHARTER 2 1/2"
MANGUERA SILICÓN-MOTOR A TUBO	SIH250363C	1996	
MANGUERA SUPERIOR-MOTOR A TUBO	CHARTER 2 1/2"	BANDA-VENT	K080605
BANDA-ALT	K050336	MANGUERA SILICÓN-TUBO A RAD.	SIH250363C



MASTER SERVICIO PESADO 2014

INTERNATIONAL/
NAVISTAR
5000

MANGUERA SUPERIOR-TUBO A RAD.	24436	MANGUERA INFERIOR-	CHARTER 2 1/2"
MANGUERA SUPERIOR-TUBO A RAD.	CHARTER 2 1/4"	1992	
MANGUERA SILICÓN-MOTOR A TUBO	SIH250363C	BANDA-VENT	K080585
MANGUERA SUPERIOR-MOTOR A TUBO	24436	BANDA-VENT	K080605
MANGUERA SUPERIOR-MOTOR A TUBO	CHARTER 2 1/4"	BANDA-VENT	K080615
BANDA-ALT	K050336	MANGUERA SUPERIOR-TUBO A RAD.	CHARTER 2 1/2"
TERMOSTATO-190°	33579	MANGUERA SUPERIOR-MOTOR A TUBO	CHARTER 2 1/4"
TERMOSTATO-180°	33576	BANDA-ALT	K050336
TERMOSTATO-180°	33578	MANGUERA DE PASO-	CHARTER 1"
TERMOSTATO-175°	33960	MANGUERA INFERIOR-	CHARTER 2 1/2"
TERMOSTATO-170°	33577	1991	
MANGUERA INFERIOR-	CHARTER 2 1/2"	BANDA-VENT	K080585
1995		BANDA-VENT	K080605
BANDA-VENT	K080605	BANDA-VENT	K080615
MANGUERA SILICÓN-TUBO A RAD.	SIH250363C	BANDA-VENT	K080630
MANGUERA SUPERIOR-TUBO A RAD.	24436	BANDA-ALT	K050336
MANGUERA SUPERIOR-TUBO A RAD.	CHARTER 2 1/4"	BANDA-AA	PQ17530
MANGUERA SILICÓN-MOTOR A TUBO	SIH250363C	1990	
MANGUERA SUPERIOR-MOTOR A TUBO	24436	BANDA-VENT	K080585
MANGUERA SUPERIOR-MOTOR A TUBO	CHARTER 2 1/4"	BANDA-VENT	K080605
BANDA-ALT	K050350	BANDA-VENT	K080615
TERMOSTATO-190°	33579	BANDA-VENT	K080630
TERMOSTATO-180°	33576	BANDA-ALT	K050336
TERMOSTATO-180°	33578	BANDA-AA	PQ17530
TERMOSTATO-175°	33960	CUMMINS ISM DIESEL	
TERMOSTATO-170°	33577	2000	
MANGUERA INFERIOR-	CHARTER 2 1/2"	BANDA-VENT	K080605
1994		MANGUERA SILICÓN-TUBO A RAD.	SIH250363C
BANDA-VENT	K080585	MANGUERA SUPERIOR-TUBO A RAD.	21135
BANDA-VENT	K080605	BANDA-TOMA DE FUERZA-ALT	K050336
BANDA-VENT	K080615	MANGUERA SILICÓN-MOTOR A TUBO	SIH250363C
MANGUERA SUPERIOR-TUBO A RAD.	CHARTER 2 1/4"	1999	
MANGUERA SUPERIOR-MOTOR A TUBO	CHARTER 2 1/4"	BANDA-VENT	K080605
BANDA-ALT	K050336	MANGUERA SILICÓN-TUBO A RAD.	SIH250363C
MANGUERA INFERIOR-	CHARTER 2 1/2"	MANGUERA SUPERIOR-TUBO A RAD.	21135
1993		BANDA-TOMA DE FUERZA-ALT	K050336
BANDA-VENT	K080585	MANGUERA SILICÓN-MOTOR A TUBO	SIH250363C
BANDA-VENT	K080605	1998	
BANDA-VENT	K080615	BANDA-VENT	K080605
MANGUERA SUPERIOR-TUBO A RAD.	CHARTER 2 1/2"	MANGUERA SILICÓN-TUBO A RAD.	SIH250363C
MANGUERA SUPERIOR-MOTOR A TUBO	CHARTER 2 1/4"	MANGUERA SILICÓN-MOTOR A TUBO	SIH250363C
BANDA-ALT	K050336	BANDA-ALT	K050336
MANGUERA DE PASO-	CHARTER 1"	BANDA-	TR22525



CATERPILLAR C12 DIESEL

2000

BANDA-VENT-AA	PQ17450
MANGUERA INFERIOR-TUBO A RAD.	21135
MANGUERA SUPERIOR-MOTOR A TUBO	CHARTER 2 1/2"
BANDA-ALT-VENT	K080780
MANGUERA INFERIOR-	CHARTER 2 1/2"

1999

BANDA-VENT-AA	9447
MANGUERA INFERIOR-TUBO A RAD.	CHARTER 2 1/2"
MANGUERA SUPERIOR-TUBO A RAD.	21135
MANGUERA INFERIOR-MOTOR A TUBO	CHARTER 2 1/2"
MANGUERA SUPERIOR-MOTOR A TUBO	CHARTER 2 1/2"
BANDA-ALT-VENT	K080780
POLEA-ALT-VENT	36091
TENSOR-ALT-VENT	38506
TERMOSTATO-190°	33579
TERMOSTATO-180°	33576
TERMOSTATO-180°	33578
TERMOSTATO-170°	33577

1998

BANDA-VENT-AA	9447
MANGUERA INFERIOR-TUBO A RAD.	CHARTER 2 1/2"
MANGUERA SUPERIOR-TUBO A RAD.	21135
MANGUERA INFERIOR-MOTOR A TUBO	CHARTER 2 1/2"
MANGUERA SUPERIOR-MOTOR A TUBO	CHARTER 2 1/2"
BANDA-ALT-VENT	K080780
POLEA-ALT-VENT	36091
TENSOR-ALT-VENT	38506
TERMOSTATO-190°	33579
TERMOSTATO-180°	33576
TERMOSTATO-180°	33578
TERMOSTATO-170°	33577

CATERPILLAR C10 DIESEL

2000

BANDA-VENT-AA	9447
MANGUERA INFERIOR-TUBO A RAD.	CHARTER 2 1/2"
MANGUERA SUPERIOR-TUBO A RAD.	21135
MANGUERA INFERIOR-MOTOR A TUBO	CHARTER 2 1/2"
MANGUERA SUPERIOR-MOTOR A TUBO	CHARTER 2 1/2"
BANDA-ALT-VENT	K080780
TERMOSTATO-190°	33579
TERMOSTATO-180°	33576

TERMOSTATO-180°	33578
TERMOSTATO-170°	33577

1999

BANDA-VENT-AA	9447
MANGUERA INFERIOR-TUBO A RAD.	CHARTER 2 1/2"
MANGUERA SUPERIOR-TUBO A RAD.	21135
MANGUERA INFERIOR-MOTOR A TUBO	CHARTER 2 1/2"
MANGUERA SUPERIOR-MOTOR A TUBO	CHARTER 2 1/2"
BANDA-ALT-VENT	K080780
TERMOSTATO-190°	33579
TERMOSTATO-180°	33576
TERMOSTATO-180°	33578
TERMOSTATO-170°	33577

1998

BANDA-VENT-AA	9447
MANGUERA INFERIOR-TUBO A RAD.	CHARTER 2 1/2"
MANGUERA SUPERIOR-TUBO A RAD.	21135
MANGUERA INFERIOR-MOTOR A TUBO	CHARTER 2 1/2"
MANGUERA SUPERIOR-MOTOR A TUBO	CHARTER 2 1/2"
BANDA-ALT-VENT	K080780
TERMOSTATO-190°	33579
TERMOSTATO-180°	33576
TERMOSTATO-180°	33578
TERMOSTATO-170°	33577

CATERPILLAR 3406 DIESEL

1996

TERMOSTATO-190°	33579
TERMOSTATO-180°	33576
TERMOSTATO-180°	33578
TERMOSTATO-170°	33577

CATERPILLAR 3176 DIESEL

1997

TERMOSTATO-190°	33579
TERMOSTATO-180°	33576
TERMOSTATO-180°	33578
TERMOSTATO-170°	33577

1996

TERMOSTATO-190°	33579
TERMOSTATO-180°	33576
TERMOSTATO-180°	33578
TERMOSTATO-170°	33577

1995

TERMOSTATO-190°	33579
-----------------	-------



MASTER SERVICIO PESADO 2014

INTERNATIONAL/
NAVISTAR
5000

TERMOSTATO-180°	33576	BANDA-TOMA DE FUERZA-BA	K060408
TERMOSTATO-180°	33578	BANDA-TOMA DE FUERZA-AA	9405
TERMOSTATO-170°	33577	MANGUERA SILICÓN-MOTOR A TUBO	SIH250363C

5500

CUMMINS ISM DIESEL

2005

BANDA-TOMA DE FUERZA-AA	K060516
TENSOR-TOMA DE FUERZA-AA	38505
MANGUERA INFERIOR-RAD. A TUBO	21891
MANGUERA SUPERIOR-RAD. A TUBO	21135
MANGUERA SUPERIOR-MOTOR A TUBO	CHARTER 2 1/2"
MANGUERA SUPERIOR-MOTOR A RAD.	22742
BANDA-ALT-VENT	K080806
TENSOR-ALT-VENT	38521
MANGUERA INFERIOR-	CHARTER 2 1/2"

5500I

INTERNATIONAL/NAVISTAR DT466

2002

POLEA DEL TENSOR-VENT-AA	36091
TENSOR-VENT-AA	38512
BANDA-ALT-VENT	K080755
POLEA-ALT-VENT	36091
TENSOR-ALT-VENT	38514
BANDA-AA	K060470
TERMOSTATO-190°	33179
TERMOSTATO-190°	33957
TERMOSTATO-180°	33118

2001

POLEA DEL TENSOR-VENT-AA	36091
TENSOR-VENT-AA	38512
BANDA-ALT-VENT	K080755
POLEA-ALT-VENT	36091
TENSOR-ALT-VENT	38514
BANDA-AA	K060470
TERMOSTATO-190°	33179
TERMOSTATO-190°	33957
TERMOSTATO-180°	33118

CUMMINS N14 DIESEL

2003

MANGUERA INFERIOR-TUBO A RAD.	21891
MANGUERA SUPERIOR-TUBO A RAD.	21891
BANDA-TOMA DE FUERZA-VENT	TR28522

BANDA-ALT	9447
TERMOSTATO-190°	33579
TERMOSTATO-180°	33576
TERMOSTATO-180°	33578
TERMOSTATO-170°	33577

2002

MANGUERA INFERIOR-TUBO A RAD.	21891
MANGUERA SUPERIOR-TUBO A RAD.	21891
BANDA-TOMA DE FUERZA-VENT	TR28522
BANDA-TOMA DE FUERZA-BA	K060408
BANDA-TOMA DE FUERZA-AA	9405
MANGUERA SILICÓN-MOTOR A TUBO	SIH250363C
BANDA-ALT	9447
TERMOSTATO-190°	33579
TERMOSTATO-180°	33576
TERMOSTATO-180°	33578
TERMOSTATO-170°	33577

2001

BANDA-TOMA DE FUERZA-VENT	TR28522
BANDA-TOMA DE FUERZA-BA	K060408
BANDA-TOMA DE FUERZA-AA	9405
BANDA-ALT	9447
TERMOSTATO-190°	33579
TERMOSTATO-180°	33576
TERMOSTATO-180°	33578
TERMOSTATO-170°	33577

2000

MANGUERA INFERIOR-TUBO A RAD.	24436
MANGUERA SUPERIOR-TUBO A RAD.	20748
BANDA-TOMA DE FUERZA-VENT	TR28522
BANDA-TOMA DE FUERZA-BA	K060408
BANDA-TOMA DE FUERZA-AA	9405
MANGUERA INFERIOR-MOTOR A TUBO	24436
MANGUERA SUPERIOR-MOTOR A TUBO	24436
BANDA-ALT	9447
TERMOSTATO-190°	33579
TERMOSTATO-180°	33576
TERMOSTATO-180°	33578
TERMOSTATO-170°	33577

CUMMINS ISX DIESEL



MASTER SERVICIO PESADO 2014

INTERNATIONAL/
NAVISTAR
5500I

2007

BANDA-TOMA DE FUERZA-AA	K060637
MANGUERA INFERIOR-RAD. A TUBO	21135
MANGUERA SUPERIOR-RAD. A TUBO	21115
MANGUERA SILICÓN-MOTOR A TUBO	SIH250363C
MANGUERA SUPERIOR-MOTOR A TUBO	21135
BANDA-ALT-VENT	K120964
TENSOR-ALT-VENT	38587

2006

MANGUERA SILICÓN-TUBO A ENFRIADOR	SIH250363C
BANDA-TOMA DE FUERZA-AA	K060637
MANGUERA SILICÓN-RAD. A TUBO	SIH250363C
MANGUERA SUPERIOR-RAD. A TUBO	21135
MANGUERA SILICÓN-MOTOR A TUBO	SIH250363C
MANGUERA SUPERIOR-MOTOR A TUBO	21135
MANGUERA INFERIOR-ENFRIADOR A TUBO	21135
BANDA-ALT-VENT	K120964
TENSOR-ALT-VENT	38587

2005

BANDA-TOMA DE FUERZA-AA	K060637
MANGUERA SILICÓN-RAD. A TUBO	SIH250363C
MANGUERA SUPERIOR-RAD. A TUBO	21135
MANGUERA SILICÓN-MOTOR A TUBO	SIH250363C
MANGUERA SUPERIOR-MOTOR A TUBO	21135
BANDA-ALT-VENT	K120964
TENSOR-ALT-VENT	38587

2004

BANDA-TOMA DE FUERZA-AA	K060637
MANGUERA SILICÓN-RAD. A TUBO	SIH250363C
MANGUERA SUPERIOR-RAD. A TUBO	21135
MANGUERA SILICÓN-MOTOR A TUBO	SIH250363C
MANGUERA SUPERIOR-MOTOR A TUBO	21135
BANDA-ALT-VENT	K120964
TENSOR-ALT-VENT	38587

2003

BANDA-TOMA DE FUERZA-AA	K060637
MANGUERA SILICÓN-RAD. A TUBO	SIH250363C
MANGUERA SUPERIOR-RAD. A TUBO	21135
MANGUERA SILICÓN-MOTOR A TUBO	SIH250363C
MANGUERA SUPERIOR-MOTOR A TUBO	21135
BANDA-ALT-VENT	K120964
TENSOR-ALT-VENT	38587

CUMMINS ISM DIESEL

2006

MANGUERA INFERIOR-TUBO A ENFRIADOR	21135
BANDA-TOMA DE FUERZA-AA	K060516
TENSOR-TOMA DE FUERZA-AA	38505
MANGUERA INFERIOR-RAD. A TUBO	21891
MANGUERA SUPERIOR-RAD. A TUBO	21135
MANGUERA INFERIOR-MOTOR A TUBO	21135
MANGUERA SILICÓN-MOTOR A TUBO	SIH250363C
MANGUERA SILICÓN-ENFRIADOR A TUBO	SIH250363C

BANDA-ALT-VENT	K080806
TENSOR-ALT-VENT	38622
POLEA DEL TENSOR-	36091

2005

BANDA-TOMA DE FUERZA-AA	K060516
TENSOR-TOMA DE FUERZA-AA	38505
MANGUERA INFERIOR-RAD. A TUBO	21891
MANGUERA SUPERIOR-RAD. A TUBO	21135
MANGUERA SILICÓN-MOTOR A TUBO	SIH250363C
BANDA-ALT-VENT	K080806
TENSOR-ALT-VENT	38622
POLEA DEL TENSOR-	36091

2004

BANDA-TOMA DE FUERZA-AA	K060516
TENSOR-TOMA DE FUERZA-AA	38505
MANGUERA SILICÓN-RAD. A TUBO	SIH250363C
MANGUERA SUPERIOR-RAD. A TUBO	21135
MANGUERA SILICÓN-MOTOR A TUBO	SIH250363C
BANDA-ALT-VENT	K080806
TENSOR-ALT-VENT	38521
POLEA DEL TENSOR-	36091

2003

BANDA-TOMA DE FUERZA-AA	K060516
TENSOR-TOMA DE FUERZA-AA	38505
MANGUERA SILICÓN-RAD. A TUBO	SIH250363C
MANGUERA SUPERIOR-RAD. A TUBO	21135
MANGUERA SILICÓN-MOTOR A TUBO	SIH250363C
BANDA-ALT-VENT	K080806
TENSOR-ALT-VENT	38521
POLEA DEL TENSOR-	36091

2002

BANDA-TOMA DE FUERZA-AA	K060516
TENSOR-TOMA DE FUERZA-AA	38505
MANGUERA SILICÓN-RAD. A TUBO	SIH250363C



MANGUERA SUPERIOR-RAD. A TUBO	21135	POLEA-MOTOR	36093
MANGUERA SILICÓN-MOTOR A TUBO	SIH250363C	MANGUERA SILICÓN-ENFRIADOR A TUBO	SIH250363C
BANDA-ALT-VENT	K080806	BANDA-ALT-VENT-AA	K081092
TENSOR-ALT-VENT	38521	TENSOR-ALT-VENT-AA	38590
POLEA DEL TENSOR-	36091	TERMOSTATO-190°	33579
2000		TERMOSTATO-180°	33576
BANDA-VENT	K080645	TERMOSTATO-180°	33578
MANGUERA INFERIOR-TUBO A RAD.	24436	TERMOSTATO-170°	33577
MANGUERA SUPERIOR-TUBO A RAD.	20748	2005	
BANDA-TOMA DE FUERZA-ALT	K050336	MANGUERA SUPERIOR-RAD. A TUBO	21115
BANDA-TOMA DE FUERZA-AA	TR22525	MANGUERA INFERIOR-RAD. A ENFRIADOR	21135
MANGUERA INFERIOR-MOTOR A TUBO	24436	MANGUERA SILICÓN-MOTOR A TUBO	SIH250363C
MANGUERA SUPERIOR-MOTOR A TUBO	24436	MANGUERA SUPERIOR-MOTOR A RAD.	21135
CATERPILLAR C15 DIESEL		POLEA-MOTOR	36093
2007		MANGUERA SILICÓN-ENFRIADOR A TUBO	SIH250363C
TERMOSTATO-190°	33579	BANDA-ALT-VENT-AA	K081092
TERMOSTATO-180°	33576	TENSOR-ALT-VENT-AA	38590
TERMOSTATO-180°	33578	TERMOSTATO-190°	33579
TERMOSTATO-170°	33577	TERMOSTATO-180°	33576
2006		TERMOSTATO-180°	33578
TERMOSTATO-190°	33579	TERMOSTATO-170°	33577
TERMOSTATO-180°	33576	CATERPILLAR C12 DIESEL	
TERMOSTATO-180°	33578	2004	
TERMOSTATO-170°	33577	BANDA-VENT-AA	K060478
CATERPILLAR C13 DIESEL		TENSOR-VENT-AA	38534
2007		MANGUERA INFERIOR-RAD. A TUBO	21891
MANGUERA SUPERIOR-RAD. A TUBO	21115	MANGUERA SUPERIOR-RAD. A TUBO	21891
MANGUERA INFERIOR-RAD. A ENFRIADOR	21135	MANGUERA SILICÓN-MOTOR A TUBO	SIH250363C
MANGUERA SILICÓN-MOTOR A TUBO	SIH250363C	MANGUERA SUPERIOR-MOTOR A TUBO	21891
MANGUERA SUPERIOR-MOTOR A RAD.	21135	BANDA-ALT-VENT	K081005
POLEA-MOTOR	36093	POLEA-ALT-VENT	36091
MANGUERA SILICÓN-ENFRIADOR A TUBO	SIH250363C	TENSOR-ALT-VENT	38506
BANDA-ALT-VENT-AA	K081092	TERMOSTATO-190°	33579
TENSOR-ALT-VENT-AA	38590	TERMOSTATO-180°	33576
TERMOSTATO-190°	33579	TERMOSTATO-180°	33578
TERMOSTATO-180°	33576	TERMOSTATO-170°	33577
TERMOSTATO-180°	33578	2003	
TERMOSTATO-170°	33577	BANDA-VENT-AA	K060478
2006		TENSOR-VENT-AA	38534
MANGUERA SUPERIOR-RAD. A TUBO	21115	MANGUERA INFERIOR-RAD. A TUBO	21891
MANGUERA INFERIOR-RAD. A ENFRIADOR	21135	MANGUERA SUPERIOR-RAD. A TUBO	21891
MANGUERA SILICÓN-MOTOR A TUBO	SIH250363C	MANGUERA SILICÓN-MOTOR A TUBO	SIH250363C
MANGUERA SUPERIOR-MOTOR A RAD.	21135	MANGUERA SUPERIOR-MOTOR A TUBO	21891



MASTER SERVICIO PESADO 2014

INTERNATIONAL/
NAVISTAR
5500I

BANDA-ALT-VENT	K081005	TENSOR-VENT-AA	38534
POLEA-ALT-VENT	36091	MANGUERA INFERIOR-RAD. A TUBO	21891
TENSOR-ALT-VENT	38506	MANGUERA SUPERIOR-RAD. A TUBO	21891
TERMOSTATO-190°	33579	MANGUERA SILICÓN-MOTOR A TUBO	SIH250363C
TERMOSTATO-180°	33576	MANGUERA SUPERIOR-MOTOR A TUBO	21891
TERMOSTATO-180°	33578	BANDA-ALT-VENT	K081005
TERMOSTATO-170°	33577	POLEA-ALT-VENT	36091
2002		TENSOR-ALT-VENT	38506
BANDA-VENT-AA	9447	TERMOSTATO-190°	33579
MANGUERA INFERIOR-TUBO A RAD.	CHARTER 2 1/2"	TERMOSTATO-180°	33576
MANGUERA SUPERIOR-TUBO A RAD.	CHARTER 2 1/2"	TERMOSTATO-180°	33578
MANGUERA INFERIOR-MOTOR A TUBO	CHARTER 2 1/2"	TERMOSTATO-170°	33577
MANGUERA SUPERIOR-MOTOR A TUBO	21335	2003	
BANDA-ALT-VENT	K080780	BANDA-VENT-AA	K060478
TERMOSTATO-190°	33579	TENSOR-VENT-AA	38534
TERMOSTATO-180°	33576	MANGUERA INFERIOR-RAD. A TUBO	21891
TERMOSTATO-180°	33578	MANGUERA SUPERIOR-RAD. A TUBO	21891
TERMOSTATO-170°	33577	MANGUERA SILICÓN-MOTOR A TUBO	SIH250363C
2001		MANGUERA SUPERIOR-MOTOR A TUBO	21891
BANDA-VENT-AA	9447	BANDA-ALT-VENT	K081005
MANGUERA INFERIOR-TUBO A RAD.	CHARTER 2 1/2"	POLEA-ALT-VENT	36091
MANGUERA SUPERIOR-TUBO A RAD.	CHARTER 2 1/2"	TENSOR-ALT-VENT	38506
MANGUERA INFERIOR-MOTOR A TUBO	CHARTER 2 1/2"	TERMOSTATO-190°	33579
MANGUERA SUPERIOR-MOTOR A TUBO	21335	TERMOSTATO-180°	33576
BANDA-ALT-VENT	K080780	TERMOSTATO-180°	33578
TERMOSTATO-190°	33579	TERMOSTATO-170°	33577
TERMOSTATO-180°	33576	2002	
TERMOSTATO-180°	33578	BANDA-VENT-AA	9447
TERMOSTATO-170°	33577	MANGUERA INFERIOR-TUBO A RAD.	CHARTER 2 1/2"
2000		MANGUERA SUPERIOR-TUBO A RAD.	CHARTER 2 1/2"
BANDA-VENT-AA	9447	MANGUERA INFERIOR-MOTOR A TUBO	CHARTER 2 1/2"
MANGUERA INFERIOR-TUBO A RAD.	CHARTER 2 1/2"	MANGUERA SUPERIOR-MOTOR A TUBO	21335
MANGUERA SUPERIOR-TUBO A RAD.	CHARTER 2 1/2"	BANDA-ALT-VENT	K080780
MANGUERA INFERIOR-MOTOR A TUBO	CHARTER 2 1/2"	TERMOSTATO-190°	33579
MANGUERA SUPERIOR-MOTOR A TUBO	21335	TERMOSTATO-180°	33576
BANDA-ALT-VENT	K080780	TERMOSTATO-180°	33578
TERMOSTATO-190°	33579	TERMOSTATO-170°	33577
TERMOSTATO-180°	33576	2001	
TERMOSTATO-180°	33578	BANDA-VENT-AA	9447
TERMOSTATO-170°	33577	MANGUERA INFERIOR-TUBO A RAD.	CHARTER 2 1/2"
CATERPILLAR C10 DIESEL		MANGUERA SUPERIOR-TUBO A RAD.	CHARTER 2 1/2"
2004		MANGUERA INFERIOR-MOTOR A TUBO	CHARTER 2 1/2"
BANDA-VENT-AA	K060478	MANGUERA SUPERIOR-MOTOR A TUBO	21335



BANDA-ALT-VENT	K080780	MANGUERA INFERIOR-	CHARTER 2 1/2"
TERMOSTATO-190°	33579	CUMMINS ISM DIESEL	
TERMOSTATO-180°	33576	2005	
TERMOSTATO-180°	33578	TENSOR-TOMA DE FUERZA-AA	38505
TERMOSTATO-170°	33577	MANGUERA INFERIOR-RAD. A TUBO	21891
2000		MANGUERA SUPERIOR-RAD. A TUBO	21135
BANDA-VENT-AA	9447	MANGUERA SUPERIOR-MOTOR A TUBO	CHARTER 2 1/2"
MANGUERA SILICÓN-TUBO A RAD.	SIH250363C	BANDA-ALT-VENT	K120964
MANGUERA SUPERIOR-TUBO A RAD.	21135	TENSOR-ALT-VENT	38521
MANGUERA SILICÓN-MOTOR A TUBO	SIH250363C	MANGUERA INFERIOR-	CHARTER 2 1/2"
BANDA-ALT-VENT	K080780	5600I	
TERMOSTATO-190°	33579	INTERNATIONAL/NAVISTAR DT466	
TERMOSTATO-180°	33576	2002	
TERMOSTATO-180°	33578	POLEA DEL TENSOR-VENT-AA	36091
TERMOSTATO-170°	33577	TENSOR-VENT-AA	38512
CATERPILLAR 3406 DIESEL		BANDA-ALT-VENT	K080755
2003		POLEA-ALT-VENT	36091
TERMOSTATO-190°	33579	TENSOR-ALT-VENT	38514
TERMOSTATO-180°	33576	BANDA-AA	K060470
TERMOSTATO-180°	33578	TERMOSTATO-190°	33179
TERMOSTATO-170°	33577	TERMOSTATO-190°	33957
2002		TERMOSTATO-180°	33118
TERMOSTATO-190°	33579	2001	
TERMOSTATO-180°	33576	POLEA DEL TENSOR-VENT-AA	36091
TERMOSTATO-180°	33578	TENSOR-VENT-AA	38512
TERMOSTATO-170°	33577	BANDA-ALT-VENT	K080755
2001		POLEA-ALT-VENT	36091
TERMOSTATO-190°	33579	TENSOR-ALT-VENT	38514
TERMOSTATO-180°	33576	BANDA-AA	K060470
TERMOSTATO-180°	33578	TERMOSTATO-190°	33179
TERMOSTATO-170°	33577	TERMOSTATO-190°	33957
2000		TERMOSTATO-180°	33118
TERMOSTATO-190°	33579	CUMMINS N14 DIESEL	
TERMOSTATO-180°	33576	2003	
TERMOSTATO-180°	33578	MANGUERA INFERIOR-TUBO A RAD.	21891
TERMOSTATO-170°	33577	MANGUERA SUPERIOR-TUBO A RAD.	21891
5600		BANDA-TOMA DE FUERZA-VENT	TR28522
CUMMINS ISX DIESEL		BANDA-TOMA DE FUERZA-BA	K060408
2005		BANDA-TOMA DE FUERZA-AA	9405
BANDA-TOMA DE FUERZA-AA	K060637	MANGUERA SILICÓN-MOTOR A TUBO	SIH250363C
MANGUERA SUPERIOR-RAD. A TUBO	21135	BANDA-ALT	9447
MANGUERA SUPERIOR-MOTOR A TUBO	21135	TERMOSTATO-190°	33579
BANDA-ALT-VENT	K080806	TERMOSTATO-180°	33576



MASTER SERVICIO PESADO 2014

INTERNATIONAL/
NAVISTAR
5600I

TERMOSTATO-180°	33578	MANGUERA SILICÓN-ENFRIADOR A TUBO	SIH250363C
TERMOSTATO-170°	33577	BANDA-ALT-VENT	K120964
2002		TENSOR-ALT-VENT	38587
MANGUERA INFERIOR-TUBO A RAD.	21891	2006	
MANGUERA SUPERIOR-TUBO A RAD.	21891	MANGUERA SILICÓN-TUBO A ENFRIADOR	SIH250363C
BANDA-TOMA DE FUERZA-VENT	TR28522	BANDA-TOMA DE FUERZA-AA	K060637
BANDA-TOMA DE FUERZA-BA	K060408	MANGUERA INFERIOR-RAD. A TUBO	21135
BANDA-TOMA DE FUERZA-AA	9405	MANGUERA SUPERIOR-RAD. A TUBO	21135
MANGUERA SILICÓN-MOTOR A TUBO	SIH250363C	MANGUERA SILICÓN-MOTOR A TUBO	SIH250363C
BANDA-ALT	9447	MANGUERA SUPERIOR-MOTOR A TUBO	21135
TERMOSTATO-190°	33579	MANGUERA SILICÓN-ENFRIADOR A TUBO	SIH250363C
TERMOSTATO-180°	33576	BANDA-ALT-VENT	K120964
TERMOSTATO-180°	33578	TENSOR-ALT-VENT	38587
TERMOSTATO-170°	33577	2005	
2001		BANDA-TOMA DE FUERZA-AA	K060637
BANDA-TOMA DE FUERZA-VENT	TR28522	MANGUERA SILICÓN-RAD. A TUBO	SIH250363C
BANDA-TOMA DE FUERZA-BA	K060408	MANGUERA SUPERIOR-RAD. A TUBO	21135
BANDA-TOMA DE FUERZA-AA	9405	MANGUERA SILICÓN-MOTOR A TUBO	SIH250363C
BANDA-ALT	9447	MANGUERA SUPERIOR-MOTOR A TUBO	21135
TERMOSTATO-190°	33579	BANDA-ALT-VENT	K120964
TERMOSTATO-180°	33576	TENSOR-ALT-VENT	38587
TERMOSTATO-180°	33578	CUMMINS ISM DIESEL	
TERMOSTATO-170°	33577	2007	
2000		BANDA-TOMA DE FUERZA-AA	K060516
MANGUERA INFERIOR-TUBO A RAD.	24436	TENSOR-TOMA DE FUERZA-AA	38505
MANGUERA SUPERIOR-TUBO A RAD.	20748	MANGUERA INFERIOR-RAD. A TUBO	21135
BANDA-TOMA DE FUERZA-VENT	TR28522	MANGUERA SILICÓN-RAD. A TUBO	SIH250363C
BANDA-TOMA DE FUERZA-BA	K060408	MANGUERA SILICÓN-MOTOR A TUBO	SIH250363C
BANDA-TOMA DE FUERZA-AA	9405	MANGUERA SUPERIOR-MOTOR A TUBO	21115
MANGUERA INFERIOR-MOTOR A TUBO	24436	BANDA-ALT-VENT	K080806
MANGUERA SUPERIOR-MOTOR A TUBO	24436	TENSOR-ALT-VENT	38622
BANDA-ALT	9447	POLEA DEL TENSOR-	36091
TERMOSTATO-190°	33579	2006	
TERMOSTATO-180°	33576	BANDA-TOMA DE FUERZA-AA	K060516
TERMOSTATO-180°	33578	TENSOR-TOMA DE FUERZA-AA	38505
TERMOSTATO-170°	33577	MANGUERA INFERIOR-RAD. A TUBO	21891
CUMMINS ISX DIESEL		MANGUERA SUPERIOR-RAD. A TUBO	21135
2007		MANGUERA SILICÓN-MOTOR A TUBO	SIH250363C
MANGUERA SILICÓN-TUBO A ENFRIADOR	SIH250363C	BANDA-ALT-VENT	K080806
BANDA-TOMA DE FUERZA-AA	K060637	TENSOR-ALT-VENT	38622
MANGUERA INFERIOR-RAD. A TUBO	21135	POLEA DEL TENSOR-	36091
MANGUERA SUPERIOR-RAD. A TUBO	21891	2005	
MANGUERA SILICÓN-MOTOR A TUBO	SIH250363C	BANDA-TOMA DE FUERZA-AA	K060516



TENSOR-TOMA DE FUERZA-AA	38505	2007	
MANGUERA INFERIOR-RAD. A TUBO	21891	TERMOSTATO-190°	33579
MANGUERA SUPERIOR-RAD. A TUBO	21135	TERMOSTATO-180°	33576
MANGUERA SILICÓN-MOTOR A TUBO	SIH250363C	TERMOSTATO-180°	33578
BANDA-ALT-VENT	K080806	TERMOSTATO-170°	33577
TENSOR-ALT-VENT	38622	2006	
POLEA DEL TENSOR-	36091	TERMOSTATO-190°	33579
2004		TERMOSTATO-180°	33576
BANDA-TOMA DE FUERZA-AA	K060516	TERMOSTATO-180°	33578
TENSOR-TOMA DE FUERZA-AA	38505	TERMOSTATO-170°	33577
MANGUERA SILICÓN-RAD. A TUBO	SIH250363C	2005	
MANGUERA SUPERIOR-RAD. A TUBO	21135	TERMOSTATO-190°	33579
MANGUERA SILICÓN-MOTOR A TUBO	SIH250363C	TERMOSTATO-180°	33576
BANDA-ALT-VENT	K080806	TERMOSTATO-180°	33578
TENSOR-ALT-VENT	38521	TERMOSTATO-170°	33577
POLEA DEL TENSOR-	36091	2004	
2003		POLEA DEL TENSOR-VENT-AA	36091
BANDA-TOMA DE FUERZA-AA	K060516	TENSOR-VENT-AA	38511
TENSOR-TOMA DE FUERZA-AA	38505	TENSOR-ALT-VENT	38569
MANGUERA SILICÓN-RAD. A TUBO	SIH250363C	BANDA-AA	K060555
MANGUERA SUPERIOR-RAD. A TUBO	21135	TERMOSTATO-190°	33579
MANGUERA SILICÓN-MOTOR A TUBO	SIH250363C	TERMOSTATO-180°	33576
BANDA-ALT-VENT	K080806	TERMOSTATO-180°	33578
TENSOR-ALT-VENT	38521	TERMOSTATO-170°	33577
POLEA DEL TENSOR-	36091	CATERPILLAR C13 DIESEL	
2002		2007	
BANDA-TOMA DE FUERZA-AA	K060516	POLEA-MOTOR	36093
TENSOR-TOMA DE FUERZA-AA	38505	TERMOSTATO-190°	33579
MANGUERA SILICÓN-RAD. A TUBO	SIH250363C	TERMOSTATO-180°	33576
MANGUERA SUPERIOR-RAD. A TUBO	21135	TERMOSTATO-180°	33578
MANGUERA SILICÓN-MOTOR A TUBO	SIH250363C	TERMOSTATO-170°	33577
BANDA-ALT-VENT	K080806	2006	
TENSOR-ALT-VENT	38521	POLEA-MOTOR	36093
POLEA DEL TENSOR-	36091	TERMOSTATO-190°	33579
2000		TERMOSTATO-180°	33576
BANDA-VENT	K080645	TERMOSTATO-180°	33578
MANGUERA INFERIOR-TUBO A RAD.	24436	TERMOSTATO-170°	33577
MANGUERA SUPERIOR-TUBO A RAD.	20748	2005	
BANDA-TOMA DE FUERZA-ALT	K050336	MANGUERA INFERIOR-RAD. A TUBO	21135
BANDA-TOMA DE FUERZA-AA	TR22525	MANGUERA SUPERIOR-RAD. A TUBO	21135
MANGUERA INFERIOR-MOTOR A TUBO	24436	MANGUERA SILICÓN-MOTOR A TUBO	SIH250363C
MANGUERA SUPERIOR-MOTOR A TUBO	24436	MANGUERA SUPERIOR-MOTOR A TUBO	21135
CATERPILLAR C15 DIESEL		POLEA-MOTOR	36093



MASTER SERVICIO PESADO 2014

INTERNATIONAL/
NAVISTAR
5600I

BANDA-ALT-VENT-AA	K081092	TERMOSTATO-180°	33576
SENSOR-ALT-VENT-AA	38590	TERMOSTATO-180°	33578
TERMOSTATO-190°	33579	TERMOSTATO-170°	33577
TERMOSTATO-180°	33576	2001	
TERMOSTATO-180°	33578	BANDA-VENT-AA	9447
TERMOSTATO-170°	33577	MANGUERA INFERIOR-TUBO A RAD.	CHARTER 2 1/2"
CATERPILLAR C12 DIESEL		MANGUERA SUPERIOR-TUBO A RAD.	CHARTER 2 1/2"
2004		MANGUERA INFERIOR-MOTOR A TUBO	CHARTER 2 1/2"
BANDA-VENT-AA	K060478	MANGUERA SUPERIOR-MOTOR A TUBO	21335
TENSOR-VENT-AA	38534	BANDA-ALT-VENT	K080780
MANGUERA INFERIOR-RAD. A TUBO	21891	TERMOSTATO-190°	33579
MANGUERA SUPERIOR-RAD. A TUBO	21891	TERMOSTATO-180°	33576
MANGUERA SILICÓN-MOTOR A TUBO	SIH250363C	TERMOSTATO-180°	33578
MANGUERA SUPERIOR-MOTOR A TUBO	21891	TERMOSTATO-170°	33577
BANDA-ALT-VENT	K081005	2000	
POLEA-ALT-VENT	36091	BANDA-VENT-AA	9447
TENSOR-ALT-VENT	38506	MANGUERA INFERIOR-TUBO A RAD.	CHARTER 2 1/2"
TERMOSTATO-190°	33579	MANGUERA SUPERIOR-TUBO A RAD.	CHARTER 2 1/2"
TERMOSTATO-180°	33576	MANGUERA INFERIOR-MOTOR A TUBO	CHARTER 2 1/2"
TERMOSTATO-180°	33578	MANGUERA SUPERIOR-MOTOR A TUBO	21335
TERMOSTATO-170°	33577	BANDA-ALT-VENT	K080780
2003		TERMOSTATO-190°	33579
BANDA-VENT-AA	K060478	TERMOSTATO-180°	33576
TENSOR-VENT-AA	38534	TERMOSTATO-180°	33578
MANGUERA INFERIOR-RAD. A TUBO	21891	TERMOSTATO-170°	33577
MANGUERA SUPERIOR-RAD. A TUBO	21891	CATERPILLAR C11 DIESEL	
MANGUERA SILICÓN-MOTOR A TUBO	SIH250363C	2007	
MANGUERA SUPERIOR-MOTOR A TUBO	21891	TERMOSTATO-190°	33579
BANDA-ALT-VENT	K081005	TERMOSTATO-180°	33576
POLEA-ALT-VENT	36091	TERMOSTATO-180°	33578
TENSOR-ALT-VENT	38506	TERMOSTATO-170°	33577
TERMOSTATO-190°	33579	2006	
TERMOSTATO-180°	33576	TERMOSTATO-190°	33579
TERMOSTATO-180°	33578	TERMOSTATO-180°	33576
TERMOSTATO-170°	33577	TERMOSTATO-180°	33578
2002		TERMOSTATO-170°	33577
BANDA-VENT-AA	9447	CATERPILLAR C10 DIESEL	
MANGUERA INFERIOR-TUBO A RAD.	CHARTER 2 1/2"	2004	
MANGUERA SUPERIOR-TUBO A RAD.	CHARTER 2 1/2"	BANDA-VENT-AA	K060478
MANGUERA INFERIOR-MOTOR A TUBO	CHARTER 2 1/2"	TENSOR-VENT-AA	38534
MANGUERA SUPERIOR-MOTOR A TUBO	21335	MANGUERA INFERIOR-RAD. A TUBO	21891
BANDA-ALT-VENT	K080780	MANGUERA SUPERIOR-RAD. A TUBO	21891
TERMOSTATO-190°	33579	MANGUERA SILICÓN-MOTOR A TUBO	SIH250363C



MASTER SERVICIO PESADO 2014

INTERNATIONAL/
NAVISTAR
56001

MANGUERA SUPERIOR-MOTOR A TUBO	21891	TERMOSTATO-180°	33576
BANDA-ALT-VENT	K081005	TERMOSTATO-180°	33578
POLEA-ALT-VENT	36091	TERMOSTATO-170°	33577
TENSOR-ALT-VENT	38506	2000	
TERMOSTATO-190°	33579	BANDA-VENT-AA	9447
TERMOSTATO-180°	33576	MANGUERA SILICÓN-TUBO A RAD.	SIH250363C
TERMOSTATO-180°	33578	MANGUERA SUPERIOR-TUBO A RAD.	21135
TERMOSTATO-170°	33577	MANGUERA SILICÓN-MOTOR A TUBO	SIH250363C
2003		BANDA-ALT-VENT	K080780
BANDA-VENT-AA	K060478	TERMOSTATO-190°	33579
TENSOR-VENT-AA	38534	TERMOSTATO-180°	33576
MANGUERA INFERIOR-RAD. A TUBO	21891	TERMOSTATO-180°	33578
MANGUERA SUPERIOR-RAD. A TUBO	21891	TERMOSTATO-170°	33577
MANGUERA SILICÓN-MOTOR A TUBO	SIH250363C	CATERPILLAR 3406 DIESEL	
MANGUERA SUPERIOR-MOTOR A TUBO	21891	2003	
BANDA-ALT-VENT	K081005	TERMOSTATO-190°	33579
POLEA-ALT-VENT	36091	TERMOSTATO-180°	33576
TENSOR-ALT-VENT	38506	TERMOSTATO-180°	33578
TERMOSTATO-190°	33579	TERMOSTATO-170°	33577
TERMOSTATO-180°	33576	2002	
TERMOSTATO-180°	33578	TERMOSTATO-190°	33579
TERMOSTATO-170°	33577	TERMOSTATO-180°	33576
2002		TERMOSTATO-180°	33578
BANDA-VENT-AA	9447	TERMOSTATO-170°	33577
MANGUERA INFERIOR-TUBO A RAD.	CHARTER 2 1/2"	2001	
MANGUERA SUPERIOR-TUBO A RAD.	CHARTER 2 1/2"	TERMOSTATO-190°	33579
MANGUERA INFERIOR-MOTOR A TUBO	CHARTER 2 1/2"	TERMOSTATO-180°	33576
MANGUERA SUPERIOR-MOTOR A TUBO	21335	TERMOSTATO-180°	33578
BANDA-ALT-VENT	K080780	TERMOSTATO-170°	33577
POLEA-ALT-VENT	36091	2000	
TENSOR-ALT-VENT	38506	TERMOSTATO-190°	33579
TERMOSTATO-190°	33579	TERMOSTATO-180°	33576
TERMOSTATO-180°	33576	TERMOSTATO-180°	33578
TERMOSTATO-180°	33578	TERMOSTATO-170°	33577
TERMOSTATO-170°	33577	59001	
2001		CUMMINS N14 DIESEL	
BANDA-VENT-AA	9447	2003	
MANGUERA INFERIOR-TUBO A RAD.	CHARTER 2 1/2"	MANGUERA INFERIOR-TUBO A RAD.	21891
MANGUERA SUPERIOR-TUBO A RAD.	CHARTER 2 1/2"	MANGUERA SUPERIOR-TUBO A RAD.	21891
MANGUERA INFERIOR-MOTOR A TUBO	CHARTER 2 1/2"	BANDA-TOMA DE FUERZA-VENT	TR28522
MANGUERA SUPERIOR-MOTOR A TUBO	21335	BANDA-TOMA DE FUERZA-BA	K060408
BANDA-ALT-VENT	K080780	BANDA-TOMA DE FUERZA-AA	9405
TERMOSTATO-190°	33579	MANGUERA SILICÓN-MOTOR A TUBO	SIH250363C



MASTER SERVICIO PESADO 2014

INTERNATIONAL/
NAVISTAR
5900I

BANDA-ALT	9447	MANGUERA SUPERIOR-RAD. A TUBO	21891
TERMOSTATO-190°	33579	MANGUERA SILICÓN-MOTOR A TUBO	SIH250363C
TERMOSTATO-180°	33576	MANGUERA SUPERIOR-MOTOR A TUBO	21135
TERMOSTATO-180°	33578	BANDA-ALT-VENT	K120964
TERMOSTATO-170°	33577	TENSOR-ALT-VENT	38587
2002		2006	
MANGUERA INFERIOR-TUBO A RAD.	21891	BANDA-TOMA DE FUERZA-AA	K060637
MANGUERA SUPERIOR-TUBO A RAD.	21891	MANGUERA INFERIOR-RAD. A TUBO	21135
BANDA-TOMA DE FUERZA-VENT	TR28522	MANGUERA SUPERIOR-RAD. A TUBO	21135
BANDA-TOMA DE FUERZA-BA	K060408	MANGUERA SILICÓN-MOTOR A TUBO	SIH250363C
BANDA-TOMA DE FUERZA-AA	9405	MANGUERA SUPERIOR-MOTOR A TUBO	21135
MANGUERA SILICÓN-MOTOR A TUBO	SIH250363C	BANDA-ALT-VENT	K120964
BANDA-ALT	9447	TENSOR-ALT-VENT	38587
TERMOSTATO-190°	33579	2005	
TERMOSTATO-180°	33576	BANDA-TOMA DE FUERZA-AA	K060637
TERMOSTATO-180°	33578	MANGUERA SILICÓN-RAD. A TUBO	SIH250363C
TERMOSTATO-170°	33577	MANGUERA SUPERIOR-RAD. A TUBO	21135
2001		MANGUERA SILICÓN-MOTOR A TUBO	SIH250363C
BANDA-TOMA DE FUERZA-VENT	TR28522	MANGUERA SUPERIOR-MOTOR A TUBO	21135
BANDA-TOMA DE FUERZA-BA	K060408	BANDA-ALT-VENT	K120964
BANDA-TOMA DE FUERZA-AA	9405	TENSOR-ALT-VENT	38587
BANDA-ALT	9447	2004	
TERMOSTATO-190°	33579	BANDA-TOMA DE FUERZA-AA	K060637
TERMOSTATO-180°	33576	MANGUERA INFERIOR-RAD. A TUBO	21135
TERMOSTATO-180°	33578	MANGUERA SUPERIOR-RAD. A TUBO	21135
TERMOSTATO-170°	33577	MANGUERA SILICÓN-MOTOR A TUBO	SIH250363C
2000		MANGUERA SUPERIOR-MOTOR A TUBO	21135
MANGUERA INFERIOR-TUBO A RAD.	24436	BANDA-ALT-VENT	K120964
MANGUERA SUPERIOR-TUBO A RAD.	20748	TENSOR-ALT-VENT	38587
BANDA-TOMA DE FUERZA-VENT	TR28522	2003	
BANDA-TOMA DE FUERZA-BA	K060408	BANDA-TOMA DE FUERZA-AA	K060637
BANDA-TOMA DE FUERZA-AA	9405	MANGUERA INFERIOR-RAD. A TUBO	21135
MANGUERA INFERIOR-MOTOR A TUBO	24436	MANGUERA SUPERIOR-RAD. A TUBO	21135
MANGUERA SUPERIOR-MOTOR A TUBO	24436	MANGUERA SILICÓN-MOTOR A TUBO	SIH250363C
BANDA-ALT	9447	MANGUERA SUPERIOR-MOTOR A TUBO	21135
TERMOSTATO-190°	33579	BANDA-ALT-VENT	K120964
TERMOSTATO-180°	33576	TENSOR-ALT-VENT	38587
TERMOSTATO-180°	33578	CUMMINS ISM DIESEL	
TERMOSTATO-170°	33577	2006	
CUMMINS ISX DIESEL		BANDA-TOMA DE FUERZA-AA	K060516
2007		TENSOR-TOMA DE FUERZA-AA	38505
BANDA-TOMA DE FUERZA-AA	K060637	MANGUERA INFERIOR-RAD. A TUBO	21891
MANGUERA INFERIOR-RAD. A TUBO	21135	MANGUERA SUPERIOR-RAD. A TUBO	21135



MASTER SERVICIO PESADO 2014

INTERNATIONAL/
NAVISTAR
59001

MANGUERA SILICÓN-MOTOR A TUBO	SIH250363C	BANDA-ALT-VENT	K080806
BANDA-ALT-VENT	K080806	TENSOR-ALT-VENT	38521
TENSOR-ALT-VENT	38622	POLEA DEL TENSOR-	36091
POLEA DEL TENSOR-	36091	2000	
2005		BANDA-VENT	K080645
BANDA-TOMA DE FUERZA-AA	K060516	MANGUERA INFERIOR-TUBO A RAD.	24436
TENSOR-TOMA DE FUERZA-AA	38505	MANGUERA SUPERIOR-TUBO A RAD.	20748
BANDA-ALT-VENT	K080806	BANDA-TOMA DE FUERZA-ALT	K050336
TENSOR-ALT-VENT	38622	BANDA-TOMA DE FUERZA-AA	TR22525
POLEA DEL TENSOR-	36091	MANGUERA INFERIOR-MOTOR A TUBO	24436
2004		MANGUERA SUPERIOR-MOTOR A TUBO	24436
BANDA-TOMA DE FUERZA-AA	K060516	CATERPILLAR C15 DIESEL	
TENSOR-TOMA DE FUERZA-AA	38505	2007	
MANGUERA SILICÓN-RAD. A TUBO	SIH250363C	TERMOSTATO-190°	33579
MANGUERA SUPERIOR-RAD. A TUBO	21135	TERMOSTATO-180°	33576
MANGUERA SILICÓN-MOTOR A TUBO	SIH250363C	TERMOSTATO-180°	33578
BANDA-ALT-VENT	K080806	TERMOSTATO-170°	33577
TENSOR-ALT-VENT	38521	2006	
POLEA DEL TENSOR-	36091	BANDA-VENT-AA	K060555
2003		POLEA DEL TENSOR-VENT-AA	36091
BANDA-TOMA DE FUERZA-AA	K060516	TENSOR-VENT-AA	38511
TENSOR-TOMA DE FUERZA-AA	38505	MANGUERA INFERIOR-RAD. A TUBO	21135
MANGUERA SILICÓN-RAD. A TUBO	SIH250363C	MANGUERA SUPERIOR-RAD. A TUBO	21135
MANGUERA SUPERIOR-RAD. A TUBO	21135	MANGUERA SILICÓN-MOTOR A TUBO	SIH300363C
MANGUERA SILICÓN-MOTOR A TUBO	SIH250363C	MANGUERA SUPERIOR-MOTOR A TUBO	21891
BANDA-ALT-VENT	K080806	BANDA-ALT-VENT	K081088
TENSOR-ALT-VENT	38521	TENSOR-ALT-VENT	38569
POLEA DEL TENSOR-	36091	TERMOSTATO-190°	33579
2002		TERMOSTATO-180°	33576
BANDA-TOMA DE FUERZA-AA	K060516	TERMOSTATO-180°	33578
TENSOR-TOMA DE FUERZA-AA	38505	TERMOSTATO-170°	33577
MANGUERA SILICÓN-RAD. A TUBO	SIH250363C	2005	
MANGUERA SUPERIOR-RAD. A TUBO	21135	BANDA-VENT-AA	K060555
MANGUERA SILICÓN-MOTOR A TUBO	SIH250363C	POLEA DEL TENSOR-VENT-AA	36091
BANDA-ALT-VENT	K080806	TENSOR-VENT-AA	38511
TENSOR-ALT-VENT	38521	MANGUERA INFERIOR-RAD. A TUBO	21135
POLEA DEL TENSOR-	36091	MANGUERA SUPERIOR-RAD. A TUBO	21135
2001		MANGUERA SILICÓN-MOTOR A TUBO	SIH300363C
BANDA-TOMA DE FUERZA-AA	K060516	MANGUERA SUPERIOR-MOTOR A TUBO	21891
TENSOR-TOMA DE FUERZA-AA	38505	BANDA-ALT-VENT	K081088
MANGUERA SILICÓN-RAD. A TUBO	SIH250363C	TENSOR-ALT-VENT	38569
MANGUERA SUPERIOR-RAD. A TUBO	21135	TERMOSTATO-190°	33579
MANGUERA SILICÓN-MOTOR A TUBO	SIH250363C	TERMOSTATO-180°	33576



MASTER SERVICIO PESADO 2014

INTERNATIONAL/
NAVISTAR
5900I

TERMOSTATO-180°	33578	BANDA-ALT-VENT	K081005
TERMOSTATO-170°	33577	POLEA-ALT-VENT	36091
2004		TENSOR-ALT-VENT	38506
BANDA-VENT-AA	K060555	TERMOSTATO-190°	33579
POLEA DEL TENSOR-VENT-AA	36091	TERMOSTATO-180°	33576
TENSOR-VENT-AA	38511	TERMOSTATO-180°	33578
MANGUERA INFERIOR-RAD. A TUBO	21135	TERMOSTATO-170°	33577
MANGUERA SUPERIOR-RAD. A TUBO	21135	2003	
MANGUERA SILICÓN-MOTOR A TUBO	SIH300363C	BANDA-VENT-AA	K060478
MANGUERA SUPERIOR-MOTOR A TUBO	21891	TENSOR-VENT-AA	38534
BANDA-ALT-VENT	K081088	MANGUERA INFERIOR-RAD. A TUBO	21135
TENSOR-ALT-VENT	38569	MANGUERA SUPERIOR-RAD. A TUBO	21135
TERMOSTATO-190°	33579	MANGUERA SILICÓN-MOTOR A TUBO	SIH250363C
TERMOSTATO-180°	33576	MANGUERA SUPERIOR-MOTOR A TUBO	21135
TERMOSTATO-180°	33578	BANDA-ALT-VENT	K081005
TERMOSTATO-170°	33577	POLEA-ALT-VENT	36091
CATERPILLAR C13 DIESEL		TENSOR-ALT-VENT	38506
2007		TERMOSTATO-190°	33579
POLEA-MOTOR	36093	TERMOSTATO-180°	33576
TERMOSTATO-190°	33579	TERMOSTATO-180°	33578
TERMOSTATO-180°	33576	TERMOSTATO-170°	33577
TERMOSTATO-180°	33578	2002	
TERMOSTATO-170°	33577	BANDA-VENT-AA	9447
2006		MANGUERA INFERIOR-TUBO A RAD.	CHARTER 2 1/2"
POLEA-MOTOR	36093	MANGUERA SUPERIOR-TUBO A RAD.	CHARTER 2 1/2"
TERMOSTATO-190°	33579	MANGUERA INFERIOR-MOTOR A TUBO	CHARTER 2 1/2"
TERMOSTATO-180°	33576	MANGUERA SUPERIOR-MOTOR A TUBO	21335
TERMOSTATO-180°	33578	BANDA-ALT-VENT	K080780
TERMOSTATO-170°	33577	POLEA-ALT-VENT	36091
2005		TENSOR-ALT-VENT	38506
POLEA-MOTOR	36093	TERMOSTATO-190°	33579
TERMOSTATO-190°	33579	TERMOSTATO-180°	33576
TERMOSTATO-180°	33576	TERMOSTATO-180°	33578
TERMOSTATO-180°	33578	TERMOSTATO-170°	33577
TERMOSTATO-170°	33577	2001	
CATERPILLAR C12 DIESEL		BANDA-VENT-AA	9447
2004		MANGUERA INFERIOR-TUBO A RAD.	CHARTER 2 1/2"
BANDA-VENT-AA	K060478	MANGUERA SUPERIOR-TUBO A RAD.	CHARTER 2 1/2"
TENSOR-VENT-AA	38534	MANGUERA INFERIOR-MOTOR A TUBO	CHARTER 2 1/2"
MANGUERA INFERIOR-RAD. A TUBO	21135	MANGUERA SUPERIOR-MOTOR A TUBO	21335
MANGUERA SUPERIOR-RAD. A TUBO	21135	BANDA-ALT-VENT	K080780
MANGUERA SILICÓN-MOTOR A TUBO	SIH250363C	TERMOSTATO-190°	33579
MANGUERA SUPERIOR-MOTOR A TUBO	21135	TERMOSTATO-180°	33576



MASTER SERVICIO PESADO 2014

INTERNATIONAL/
NAVISTAR
59001

TERMOSTATO-180°	33578	MANGUERA INFERIOR-TUBO A RAD.	CHARTER 2 1/2"
TERMOSTATO-170°	33577	MANGUERA SUPERIOR-TUBO A RAD.	CHARTER 2 1/2"
2000		MANGUERA INFERIOR-MOTOR A TUBO	CHARTER 2 1/2"
BANDA-VENT-AA	9447	MANGUERA SUPERIOR-MOTOR A TUBO	21335
MANGUERA INFERIOR-TUBO A RAD.	CHARTER 2 1/2"	BANDA-ALT-VENT	K080780
MANGUERA SUPERIOR-TUBO A RAD.	CHARTER 2 1/2"	TERMOSTATO-190°	33579
MANGUERA INFERIOR-MOTOR A TUBO	CHARTER 2 1/2"	TERMOSTATO-180°	33576
MANGUERA SUPERIOR-MOTOR A TUBO	21335	TERMOSTATO-180°	33578
BANDA-ALT-VENT	K080780	TERMOSTATO-170°	33577
TERMOSTATO-190°	33579	2000	
TERMOSTATO-180°	33576	BANDA-VENT-AA	9447
TERMOSTATO-180°	33578	MANGUERA SILICÓN-TUBO A RAD.	SIH250363C
TERMOSTATO-170°	33577	MANGUERA SUPERIOR-TUBO A RAD.	21135
CATERPILLAR C10 DIESEL		MANGUERA SILICÓN-MOTOR A TUBO	SIH250363C
2003		BANDA-ALT-VENT	K080780
BANDA-VENT-AA	K060478	POLEA-ALT-VENT	36091
TENSOR-VENT-AA	38534	TENSOR-ALT-VENT	38506
MANGUERA INFERIOR-RAD. A TUBO	21135	TERMOSTATO-190°	33579
MANGUERA SUPERIOR-RAD. A TUBO	21135	TERMOSTATO-180°	33576
MANGUERA SILICÓN-MOTOR A TUBO	SIH250363C	TERMOSTATO-180°	33578
MANGUERA SUPERIOR-MOTOR A TUBO	21135	TERMOSTATO-170°	33577
BANDA-ALT-VENT	K081005	CATERPILLAR 3406 DIESEL	
POLEA-ALT-VENT	36091	2003	
TENSOR-ALT-VENT	38506	TERMOSTATO-190°	33579
TERMOSTATO-190°	33579	TERMOSTATO-180°	33576
TERMOSTATO-180°	33576	TERMOSTATO-180°	33578
TERMOSTATO-180°	33578	TERMOSTATO-170°	33577
TERMOSTATO-170°	33577	2002	
2002		TERMOSTATO-190°	33579
BANDA-VENT-AA	9447	TERMOSTATO-180°	33576
MANGUERA INFERIOR-TUBO A RAD.	CHARTER 2 1/2"	TERMOSTATO-180°	33578
MANGUERA SUPERIOR-TUBO A RAD.	CHARTER 2 1/2"	TERMOSTATO-170°	33577
MANGUERA INFERIOR-MOTOR A TUBO	CHARTER 2 1/2"	2001	
MANGUERA SUPERIOR-MOTOR A TUBO	21335	TERMOSTATO-190°	33579
BANDA-ALT-VENT	K080780	TERMOSTATO-180°	33576
POLEA-ALT-VENT	36091	TERMOSTATO-180°	33578
TENSOR-ALT-VENT	38506	TERMOSTATO-170°	33577
TERMOSTATO-190°	33579	2000	
TERMOSTATO-180°	33576	TERMOSTATO-190°	33579
TERMOSTATO-180°	33578	TERMOSTATO-180°	33576
TERMOSTATO-170°	33577	TERMOSTATO-180°	33578
2001		TERMOSTATO-170°	33577
BANDA-VENT-AA	9447		

7100



INTERNATIONAL/NAVISTAR DT466

1995

BANDA-VENT-AA	K060470
POLEA DEL TENSOR-VENT-AA	36091
TENSOR-VENT-AA	38511
MANGUERA INFERIOR-TUBO A RAD.	21115
MANGUERA INFERIOR-MOTOR A TUBO	21842
MANGUERA INFERIOR-MOTOR A RAD.	21842
MANGUERA SUPERIOR-MOTOR A RAD.	21765
BANDA-ALT-VENT	K080726
BANDA-ALT-VENT	K080730
BANDA-ALT-VENT	K080738
BANDA-ALT-VENT	K080774
POLEA-ALT-VENT	36091
TENSOR-ALT-VENT	38514
TERMOSTATO-190°	33179
TERMOSTATO-190°	33957
TERMOSTATO-180°	33118

7300

INTERNATIONAL/NAVISTAR DT466

2007

TERMOSTATO-190°	33179
TERMOSTATO-190°	33957
TERMOSTATO-180°	33118

2006

BANDA-TOMA DE FUERZA-ALT-VENT-AA	K080926
TENSOR-TOMA DE FUERZA-ALT-VENT-AA	38620
MANGUERA SILICÓN-RAD. A TUBO	SIH250363C
MANGUERA SUPERIOR-MOTOR A RAD.	21194
TERMOSTATO-190°	33179
TERMOSTATO-190°	33957
TERMOSTATO-180°	33118

2005

BANDA-TOMA DE FUERZA-ALT-VENT-AA	K080934
TENSOR-TOMA DE FUERZA-ALT-VENT-AA	38620
TERMOSTATO-190°	33179
TERMOSTATO-190°	33957
TERMOSTATO-180°	33118

2004

TERMOSTATO-190°	33179
TERMOSTATO-190°	33957
TERMOSTATO-180°	33118

2003

BANDA-VENT-AA	K060458
POLEA DEL TENSOR-VENT-AA	36091
TENSOR-VENT-AA	38511
BANDA-ALT-VENT	K080774
POLEA-ALT-VENT	36091
TENSOR-ALT-VENT	38514
TERMOSTATO-190°	33179
TERMOSTATO-190°	33957
TERMOSTATO-180°	33118

2002

BANDA-VENT-AA	K060458
POLEA DEL TENSOR-VENT-AA	36091
TENSOR-VENT-AA	38511
BANDA-ALT-VENT	K080774
POLEA-ALT-VENT	36091
TENSOR-ALT-VENT	38514
TERMOSTATO-190°	33179
TERMOSTATO-190°	33957
TERMOSTATO-180°	33118

7400

INTERNATIONAL/NAVISTAR DT570 DIESEL

2007

MANGUERA INFERIOR-TUBO A ENFRIADOR	21891
BANDA-TOMA DE FUERZA-ALT-VENT-AA	K080952
TENSOR-TOMA DE FUERZA-ALT-VENT-AA	38620
MANGUERA SILICÓN-RAD. A TUBO	SIH250363C
MANGUERA INFERIOR-MOTOR A TUBO	21135
MANGUERA SUPERIOR-MOTOR A TUBO	21891
MANGUERA INFERIOR-ENFRIADOR A TUBO	21891
MANGUERA INFERIOR-ENFRIADOR A RAD.	21891

2006

MANGUERA INFERIOR-TUBO A ENFRIADOR	21891
MANGUERA SUPERIOR-RAD. A TUBO	CHARTER 2 1/2"
MANGUERA INFERIOR-MOTOR A TUBO	21135
MANGUERA SUPERIOR-MOTOR A TUBO	21891
MANGUERA INFERIOR-ENFRIADOR A TUBO	21891
MANGUERA INFERIOR-ENFRIADOR A RAD.	21891
BANDA-ALT-VENT-AA	K080952

2005

MANGUERA INFERIOR-TUBO A ENFRIADOR	21891
BANDA-TOMA DE FUERZA-ALT-VENT-AA	K080952
TENSOR-TOMA DE FUERZA-ALT-VENT-AA	38620
MANGUERA SILICÓN-RAD. A TUBO	SIH250363C



MANGUERA INFERIOR-MOTOR A TUBO	21135	MANGUERA INFERIOR-MOTOR A TUBO	21135
MANGUERA SUPERIOR-MOTOR A TUBO	21891	MANGUERA SUPERIOR-MOTOR A RAD.	21194
MANGUERA INFERIOR-ENFRIADOR A TUBO	21891	TERMOSTATO-190°	33179
MANGUERA INFERIOR-ENFRIADOR A RAD.	21891	TERMOSTATO-190°	33957
INTERNATIONAL/NAVISTAR DT530 DIESEL		TERMOSTATO-180°	33118
2005		2005	
BANDA-VENT-AA	K060458	MANGUERA SILICÓN-TUBO A ENFRIADOR	SIH250363C
MANGUERA SILICÓN-TUBO A RAD.	SIH250363C	BANDA-TOMA DE FUERZA-ALT-VENT-AA	K080926
BANDA-TOMA DE FUERZA-ALT-VENT	K080760	BANDA-TOMA DE FUERZA-ALT-VENT-AA	K080934
POLEA DEL TENSOR-TOMA DE FUERZA-ALT-VENT	36091	TENSOR-TOMA DE FUERZA-ALT-VENT-AA	38620
TENSOR-TOMA DE FUERZA-ALT-VENT	38514	MANGUERA INFERIOR-RAD. A TUBO	21135
MANGUERA SUPERIOR-MOTOR A TUBO	24436	MANGUERA SILICÓN-RAD. A TUBO	SIH250363C
MANGUERA INFERIOR-MOTOR A RAD.	22762	MANGUERA INFERIOR-MOTOR A TUBO	21135
TENSOR-AA	38511	MANGUERA SUPERIOR-MOTOR A RAD.	21194
POLEA DEL TENSOR-	36091	TERMOSTATO-190°	33179
2004		TERMOSTATO-190°	33957
BANDA-VENT-AA	K060458	TERMOSTATO-180°	33118
MANGUERA SILICÓN-TUBO A RAD.	SIH250363C	2004	
BANDA-TOMA DE FUERZA-ALT-VENT	K080760	TERMOSTATO-190°	33179
POLEA DEL TENSOR-TOMA DE FUERZA-ALT-VENT	36091	TERMOSTATO-190°	33957
TENSOR-TOMA DE FUERZA-ALT-VENT	38514	TERMOSTATO-180°	33118
MANGUERA SUPERIOR-MOTOR A TUBO	24436	2003	
MANGUERA INFERIOR-MOTOR A RAD.	22762	BANDA-VENT-AA	K060458
TENSOR-AA	38511	POLEA DEL TENSOR-VENT-AA	36091
POLEA DEL TENSOR-	36091	TENSOR-VENT-AA	38511
INTERNATIONAL/NAVISTAR DT466		MANGUERA SILICÓN-TUBO A RAD.	SIH250363C
2007		MANGUERA SUPERIOR-MOTOR A TUBO	24436
MANGUERA SILICÓN-TUBO A ENFRIADOR	SIH250363C	MANGUERA INFERIOR-MOTOR A RAD.	22762
BANDA-TOMA DE FUERZA-ALT-VENT-AA	K080926	BANDA-ALT-VENT	K080774
TENSOR-TOMA DE FUERZA-ALT-VENT-AA	38620	POLEA-ALT-VENT	36091
MANGUERA INFERIOR-RAD. A TUBO	21135	TENSOR-ALT-VENT	38514
MANGUERA SILICÓN-RAD. A TUBO	SIH250363C	TERMOSTATO-190°	33179
MANGUERA INFERIOR-MOTOR A TUBO	21135	TERMOSTATO-190°	33957
MANGUERA SUPERIOR-MOTOR A RAD.	21194	TERMOSTATO-180°	33118
TERMOSTATO-190°	33179	2002	
TERMOSTATO-190°	33957	BANDA-VENT-AA	K060458
TERMOSTATO-180°	33118	POLEA DEL TENSOR-VENT-AA	36091
2006		TENSOR-VENT-AA	38511
MANGUERA SILICÓN-TUBO A ENFRIADOR	SIH250363C	MANGUERA SILICÓN-TUBO A RAD.	SIH250363C
BANDA-TOMA DE FUERZA-ALT-VENT-AA	K080926	MANGUERA SUPERIOR-MOTOR A TUBO	24436
TENSOR-TOMA DE FUERZA-ALT-VENT-AA	38620	MANGUERA INFERIOR-MOTOR A RAD.	22762
MANGUERA INFERIOR-RAD. A TUBO	21135	BANDA-ALT-VENT	K080774
MANGUERA SILICÓN-RAD. A TUBO	SIH250363C	POLEA-ALT-VENT	36091



TENSOR-ALT-VENT	38514	BANDA-ALT-VENT	K080806
TERMOSTATO-190°	33179	TENSOR-ALT-VENT	38622
TERMOSTATO-190°	33957	POLEA DEL TENSOR-	36091
TERMOSTATO-180°	33118		

7500

INTERNATIONAL/NAVISTAR 570 DIESEL

2006

MANGUERA INFERIOR-TUBO A ENFRIADOR	21891
BANDA-TOMA DE FUERZA-ALT-VENT-AA	K080952
TENSOR-TOMA DE FUERZA-ALT-VENT-AA	38620
MANGUERA SILICÓN-RAD. A TUBO	SIH250363C
MANGUERA INFERIOR-MOTOR A TUBO	21135
MANGUERA SUPERIOR-MOTOR A TUBO	21891
MANGUERA INFERIOR-ENFRIADOR A TUBO	21891
MANGUERA INFERIOR-ENFRIADOR A RAD.	21891

INTERNATIONAL/NAVISTAR 530 DIESEL

2003

BANDA-VENT-AA	K060458
POLEA DEL TENSOR-VENT-AA	36091
TENSOR-VENT-AA	38511
MANGUERA SILICÓN-TUBO A RAD.	SIH275363C
BANDA-TOMA DE FUERZA-ALT-VENT	K080760
POLEA DEL TENSOR-TOMA DE FUERZA-ALT-VENT	36091
TENSOR-TOMA DE FUERZA-ALT-VENT	38514
MANGUERA SUPERIOR-MOTOR A TUBO	24436
MANGUERA INFERIOR-MOTOR A RAD.	22762

2002

BANDA-VENT-AA	K060458
POLEA DEL TENSOR-VENT-AA	36091
TENSOR-VENT-AA	38511
MANGUERA SILICÓN-TUBO A RAD.	SIH275363C
BANDA-TOMA DE FUERZA-ALT-VENT	K080760
POLEA DEL TENSOR-TOMA DE FUERZA-ALT-VENT	36091
TENSOR-TOMA DE FUERZA-ALT-VENT	38514
MANGUERA SUPERIOR-MOTOR A TUBO	24436
MANGUERA INFERIOR-MOTOR A RAD.	22762

CUMMINS ISM DIESEL

2005

BANDA-TOMA DE FUERZA-AA	K060516
TENSOR-TOMA DE FUERZA-AA	38505
MANGUERA INFERIOR-RAD. A TUBO	21891
MANGUERA SILICÓN-RAD. A TUBO	SIH250363C
MANGUERA INFERIOR-MOTOR A TUBO	21135
MANGUERA SILICÓN-MOTOR A TUBO	SIH250363C

INTERNATIONAL/NAVISTAR HT570 DIESEL

2007

MANGUERA SILICÓN-RAD. A TUBO	SIH250363C
MANGUERA SUPERIOR-MOTOR A TUBO	21891
BANDA-ALT-VENT-AA	K080944
TENSOR-ALT-VENT-AA	38620

2006

MANGUERA SILICÓN-TUBO A ENFRIADOR	SIH250363C
MANGUERA SILICÓN-RAD. A TUBO	SIH250363C
MANGUERA SILICÓN-RAD. A TUBO	SIH275363C
MANGUERA SILICÓN-MOTOR A TUBO	SIH250363C
MANGUERA SUPERIOR-MOTOR A TUBO	21891
MANGUERA SILICÓN-ENFRIADOR A TUBO	SIH275363C
BANDA-ALT-VENT-AA	K080944
TENSOR-ALT-VENT-AA	38620

2005

MANGUERA SILICÓN-TUBO A ENFRIADOR	SIH250363C
MANGUERA SILICÓN-RAD. A TUBO	SIH250363C
MANGUERA SILICÓN-RAD. A TUBO	SIH275363C
MANGUERA SILICÓN-MOTOR A TUBO	SIH250363C
MANGUERA SUPERIOR-MOTOR A TUBO	21891
MANGUERA SILICÓN-ENFRIADOR A TUBO	SIH275363C
BANDA-ALT-VENT-AA	K080944
TENSOR-ALT-VENT-AA	38620

INTERNATIONAL/NAVISTAR HT570

2006

MANGUERA SUPERIOR-RAD. A TUBO	CHARTER 2 1/2"
MANGUERA SUPERIOR-MOTOR A TUBO	21891
BANDA-ALT-VENT-AA	K080952
MANGUERA INFERIOR-	CHARTER 2 1/2"
MANGUERA INFERIOR-	CHARTER 2 3/4"

INTERNATIONAL/NAVISTAR DT570 DIESEL

2005

MANGUERA SUPERIOR-MOTOR A TUBO	21891
MANGUERA SUPERIOR-MOTOR A TUBO	CHARTER 2 1/2"
BANDA-ALT-BA-VENT	K080922
MANGUERA INFERIOR-	CHARTER 2 1/2"
MANGUERA INFERIOR-	CHARTER 2 3/4"

INTERNATIONAL/NAVISTAR DT530 DIESEL



2005	
BANDA-VENT-AA	K060458
POLEA DEL TENSOR-VENT-AA	36091
TENSOR-VENT-AA	38511
MANGUERA SILICÓN-TUBO A RAD.	SIH250363C
MANGUERA SUPERIOR-MOTOR A TUBO	24436
MANGUERA INFERIOR-MOTOR A RAD.	22762
BANDA-ALT-VENT	K080774
POLEA-ALT-VENT	36091
TENSOR-ALT-VENT	38514

2004	
BANDA-VENT-AA	K060458
POLEA DEL TENSOR-VENT-AA	36091
TENSOR-VENT-AA	38511
MANGUERA SILICÓN-TUBO A RAD.	SIH250363C
MANGUERA SUPERIOR-MOTOR A TUBO	24436
MANGUERA INFERIOR-MOTOR A RAD.	22762
BANDA-ALT-VENT	K080774
POLEA-ALT-VENT	36091
TENSOR-ALT-VENT	38514

INTERNATIONAL/NAVISTAR DT466

2002	
BANDA-VENT-AA	K060458
POLEA DEL TENSOR-VENT-AA	36091
TENSOR-VENT-AA	38511
MANGUERA SILICÓN-TUBO A RAD.	SIH250363C
MANGUERA SUPERIOR-MOTOR A TUBO	24436
MANGUERA INFERIOR-MOTOR A RAD.	22762
BANDA-ALT-VENT	K080774
POLEA-ALT-VENT	36091
TENSOR-ALT-VENT	38514
TERMOSTATO-190°	33179
TERMOSTATO-190°	33957
TERMOSTATO-180°	33118

INTERNATIONAL/NAVISTAR 530 DIESEL

2003	
BANDA-VENT-AA	K060458
POLEA DEL TENSOR-VENT-AA	36091
TENSOR-VENT-AA	38511
MANGUERA SILICÓN-TUBO A RAD.	SIH275363C
BANDA-TOMA DE FUERZA-ALT-VENT	K080760
POLEA DEL TENSOR-TOMA DE FUERZA-ALT-VENT	36091
TENSOR-TOMA DE FUERZA-ALT-VENT	38514

MANGUERA SUPERIOR-MOTOR A TUBO	24436
MANGUERA INFERIOR-MOTOR A RAD.	22762
2002	
BANDA-VENT-AA	K060458
POLEA DEL TENSOR-VENT-AA	36091
TENSOR-VENT-AA	38511
MANGUERA SILICÓN-TUBO A RAD.	SIH275363C
BANDA-TOMA DE FUERZA-ALT-VENT	K080760
POLEA DEL TENSOR-TOMA DE FUERZA-ALT-VENT	36091
TENSOR-TOMA DE FUERZA-ALT-VENT	38514
MANGUERA SUPERIOR-MOTOR A TUBO	24436
MANGUERA INFERIOR-MOTOR A RAD.	22762

7600

CUMMINS ISM DIESEL

2007	
BANDA-TOMA DE FUERZA-AA	K060516
TENSOR-TOMA DE FUERZA-AA	38505
MANGUERA INFERIOR-RAD. A TUBO	21891
MANGUERA SILICÓN-RAD. A TUBO	SIH250363C
MANGUERA INFERIOR-MOTOR A TUBO	21135
MANGUERA SUPERIOR-MOTOR A TUBO	21891
BANDA-ALT-VENT	K080806
TENSOR-ALT-VENT	38622
POLEA DEL TENSOR-	36091

2006	
BANDA-TOMA DE FUERZA-AA	K060516
TENSOR-TOMA DE FUERZA-AA	38505
MANGUERA INFERIOR-RAD. A TUBO	21891
MANGUERA SILICÓN-RAD. A TUBO	SIH250363C
MANGUERA INFERIOR-MOTOR A TUBO	21135
MANGUERA SILICÓN-MOTOR A TUBO	SIH250363C
BANDA-ALT-VENT	K080806
TENSOR-ALT-VENT	38622
POLEA DEL TENSOR-	36091

2005	
BANDA-TOMA DE FUERZA-AA	K060516
TENSOR-TOMA DE FUERZA-AA	38505
MANGUERA INFERIOR-RAD. A TUBO	21891
MANGUERA SILICÓN-RAD. A TUBO	SIH250363C
MANGUERA INFERIOR-MOTOR A TUBO	21135
MANGUERA SILICÓN-MOTOR A TUBO	SIH250363C
BANDA-ALT-VENT	K080806
TENSOR-ALT-VENT	38622



MASTER SERVICIO PESADO 2014

INTERNATIONAL/
NAVISTAR
7600

POLEA DEL TENSOR-	36091	TENSOR-ALT-VENT-AA	38590
2004		TERMOSTATO-190°	33579
BANDA-TOMA DE FUERZA-AA	K060516	TERMOSTATO-180°	33576
TENSOR-TOMA DE FUERZA-AA	38505	TERMOSTATO-180°	33578
MANGUERA SILICÓN-RAD. A TUBO	SIH250363C	TERMOSTATO-170°	33577
MANGUERA INFERIOR-RAD. A ENFRIADOR	21891	TAPÓN DE RADIADOR-(10 LBS) SIN PALANCA	31567
MANGUERA SILICÓN-MOTOR A TUBO	SIH250363C	POLEA DEL TENSOR-	36164
MANGUERA INFERIOR-MOTOR A ENFRIADOR	21135	2006	
BANDA-ALT-VENT	K080806	MANGUERA INFERIOR-RAD. A TUBO	21894
TENSOR-ALT-VENT	38521	MANGUERA SILICÓN-RAD. A TUBO	SIH250363C
POLEA DEL TENSOR-	36091	MANGUERA SILICÓN-MOTOR A TUBO	SIH250363C
2003		POLEA-MOTOR	36269
BANDA-TOMA DE FUERZA-AA	K060516	POLEA-MOTOR	36341
TENSOR-TOMA DE FUERZA-AA	38505	BANDA-ALT-VENT-AA	K081092
MANGUERA SILICÓN-RAD. A TUBO	SIH250363C	TENSOR-ALT-VENT-AA	38590
MANGUERA INFERIOR-RAD. A ENFRIADOR	21891	TERMOSTATO-190°	33579
MANGUERA SILICÓN-MOTOR A TUBO	SIH250363C	TERMOSTATO-180°	33576
MANGUERA INFERIOR-MOTOR A ENFRIADOR	21135	TERMOSTATO-180°	33578
BANDA-ALT-VENT	K080806	TERMOSTATO-170°	33577
TENSOR-ALT-VENT	38521	TAPÓN DE RADIADOR-(10 LBS) SIN PALANCA	31567
POLEA DEL TENSOR-	36091	POLEA DEL TENSOR-	36164
CATERPILLAR C13 DIESEL		2005	
2008		MANGUERA INFERIOR-RAD. A TUBO	20206
MANGUERA INFERIOR-RAD. A TUBO	21894	MANGUERA SILICÓN-RAD. A TUBO	SIH250363C
MANGUERA SUPERIOR-RAD. A TUBO	21115	MANGUERA SILICÓN-MOTOR A TUBO	SIH250363C
MANGUERA SILICÓN-MOTOR A TUBO	SIH250363C	POLEA-MOTOR	36269
POLEA-MOTOR	36269	POLEA-MOTOR	36341
POLEA-MOTOR	36341	BANDA-ALT-VENT-AA	K081092
BANDA-ALT-VENT-AA	K081092	TENSOR-ALT-VENT-AA	38590
TENSOR-ALT-VENT-AA	38590	TERMOSTATO-190°	33579
TERMOSTATO-190°	33579	TERMOSTATO-180°	33576
TERMOSTATO-180°	33576	TERMOSTATO-180°	33578
TERMOSTATO-180°	33578	TERMOSTATO-170°	33577
TERMOSTATO-170°	33577	TAPÓN DE RADIADOR-(10 LBS) SIN PALANCA	31567
TAPÓN DE RADIADOR-(10 LBS) SIN PALANCA	31567	POLEA DEL TENSOR-	36164
POLEA DEL TENSOR-	36164	2004	
2007		MANGUERA INFERIOR-RAD. A TUBO	20206
MANGUERA INFERIOR-RAD. A TUBO	21894	MANGUERA SILICÓN-RAD. A TUBO	SIH250363C
MANGUERA SUPERIOR-RAD. A TUBO	21115	MANGUERA SILICÓN-MOTOR A TUBO	SIH250363C
MANGUERA SILICÓN-MOTOR A TUBO	SIH250363C	POLEA-MOTOR	36269
POLEA-MOTOR	36269	POLEA-MOTOR	36341
POLEA-MOTOR	36341	BANDA-ALT-VENT-AA	K081092
BANDA-ALT-VENT-AA	K081092	TENSOR-ALT-VENT-AA	38590



MASTER SERVICIO PESADO 2014

INTERNATIONAL/
NAVISTAR
7600

TERMOSTATO-190°	33579	MANGUERA SUPERIOR-MOTOR A TUBO	21135
TERMOSTATO-180°	33576	BANDA-ALT-VENT	K080986
TERMOSTATO-180°	33578	POLEA-ALT-VENT	36091
TERMOSTATO-170°	33577	TENSOR-ALT-VENT	38506
TAPÓN DE RADIADOR-(10 LBS) SIN PALANCA	31567	TERMOSTATO-190°	33579
POLEA DEL TENSOR-	36164	TERMOSTATO-180°	33576
CATERPILLAR C12 DIESEL		TERMOSTATO-180°	33578
2004		TERMOSTATO-170°	33577
BANDA-VENT-AA	K060478	CATERPILLAR C11 DIESEL	
TENSOR-VENT-AA	38534	2007	
MANGUERA INFERIOR-RAD. A TUBO	21891	MANGUERA INFERIOR-RAD. A TUBO	21894
MANGUERA SILICÓN-RAD. A TUBO	SIH250363C	MANGUERA SILICÓN-MOTOR A TUBO	SIH250363C
MANGUERA SILICÓN-MOTOR A TUBO	SIH250363C	BANDA-ALT-VENT-AA	K081092
MANGUERA SUPERIOR-MOTOR A TUBO	21135	TENSOR-ALT-VENT-AA	38590
BANDA-ALT-VENT	K081005	TERMOSTATO-190°	33579
POLEA-ALT-VENT	36091	TERMOSTATO-180°	33576
TENSOR-ALT-VENT	38506	TERMOSTATO-180°	33578
TERMOSTATO-190°	33579	TERMOSTATO-170°	33577
TERMOSTATO-180°	33576	2006	
TERMOSTATO-180°	33578	MANGUERA INFERIOR-RAD. A TUBO	21894
TERMOSTATO-170°	33577	MANGUERA SILICÓN-RAD. A TUBO	SIH250363C
2003		MANGUERA SILICÓN-MOTOR A TUBO	SIH250363C
BANDA-VENT-AA	K060483	BANDA-ALT-VENT-AA	K081092
POLEA DEL TENSOR-VENT-AA	36091	TENSOR-ALT-VENT-AA	38590
TENSOR-VENT-AA	38507	TERMOSTATO-190°	33579
MANGUERA INFERIOR-TUBO A RAD.	21891	TERMOSTATO-180°	33576
MANGUERA SILICÓN-TUBO A RAD.	SIH250363C	TERMOSTATO-180°	33578
MANGUERA SILICÓN-MOTOR A TUBO	SIH250363C	TERMOSTATO-170°	33577
MANGUERA SUPERIOR-MOTOR A TUBO	21135	2005	
BANDA-ALT-VENT	K080986	MANGUERA INFERIOR-RAD. A TUBO	21891
POLEA-ALT-VENT	36091	MANGUERA SILICÓN-RAD. A TUBO	SIH250363C
TENSOR-ALT-VENT	38506	MANGUERA SILICÓN-MOTOR A TUBO	SIH250363C
TERMOSTATO-190°	33579	BANDA-ALT-VENT-AA	K081092
TERMOSTATO-180°	33576	TENSOR-ALT-VENT-AA	38590
TERMOSTATO-180°	33578	TERMOSTATO-190°	33579
TERMOSTATO-170°	33577	TERMOSTATO-180°	33576
2002		TERMOSTATO-180°	33578
BANDA-VENT-AA	K060483	TERMOSTATO-170°	33577
POLEA DEL TENSOR-VENT-AA	36091	2004	
TENSOR-VENT-AA	38507	MANGUERA INFERIOR-RAD. A TUBO	21891
MANGUERA INFERIOR-TUBO A RAD.	21891	MANGUERA SILICÓN-RAD. A TUBO	SIH250363C
MANGUERA SILICÓN-TUBO A RAD.	SIH250363C	MANGUERA SILICÓN-MOTOR A TUBO	SIH250363C
MANGUERA SILICÓN-MOTOR A TUBO	SIH250363C	BANDA-ALT-VENT-AA	K081092



MASTER SERVICIO PESADO 2014

INTERNATIONAL/
NAVISTAR
7600

TENSOR-ALT-VENT-AA	38590	BANDA-ALT-VENT	K080986
TERMOSTATO-190°	33579	POLEA-ALT-VENT	36091
TERMOSTATO-180°	33576	TENSOR-ALT-VENT	38506
TERMOSTATO-180°	33578	TERMOSTATO-190°	33579
TERMOSTATO-170°	33577	TERMOSTATO-180°	33576
CATERPILLAR C10 DIESEL		TERMOSTATO-180°	33578
2004		TERMOSTATO-170°	33577
BANDA-VENT-AA	K060478	CATERPILLAR 3406 DIESEL	
TENSOR-VENT-AA	38534	2003	
MANGUERA INFERIOR-RAD. A TUBO	21891	BANDA-VENT-AA	K060483
MANGUERA SILICÓN-RAD. A TUBO	SIH250363C	BANDA-ALT-VENT	K080986
MANGUERA SILICÓN-MOTOR A TUBO	SIH250363C	TERMOSTATO-190°	33579
MANGUERA SUPERIOR-MOTOR A TUBO	21135	TERMOSTATO-180°	33576
BANDA-ALT-VENT	K081005	TERMOSTATO-180°	33578
POLEA-ALT-VENT	36091	TERMOSTATO-170°	33577
TENSOR-ALT-VENT	38506	7700	
TERMOSTATO-190°	33579	CUMMINS ISM DIESEL	
TERMOSTATO-180°	33576	2006	
TERMOSTATO-180°	33578	BANDA-TOMA DE FUERZA-AA	K060516
TERMOSTATO-170°	33577	TENSOR-TOMA DE FUERZA-AA	38505
2003		MANGUERA INFERIOR-RAD. A TUBO	21891
BANDA-VENT-AA	K060483	MANGUERA SILICÓN-RAD. A TUBO	SIH250363C
POLEA DEL TENSOR-VENT-AA	36091	MANGUERA INFERIOR-MOTOR A TUBO	21135
TENSOR-VENT-AA	38507	MANGUERA SILICÓN-MOTOR A TUBO	SIH250363C
MANGUERA INFERIOR-TUBO A RAD.	21891	BANDA-ALT-VENT	K080806
MANGUERA SILICÓN-TUBO A RAD.	SIH250363C	TENSOR-ALT-VENT	38622
MANGUERA SILICÓN-MOTOR A TUBO	SIH250363C	POLEA DEL TENSOR-	36091
MANGUERA SUPERIOR-MOTOR A TUBO	21135	2005	
BANDA-ALT-VENT	K080986	BANDA-TOMA DE FUERZA-AA	K060516
POLEA-ALT-VENT	36091	TENSOR-TOMA DE FUERZA-AA	38505
TENSOR-ALT-VENT	38506	MANGUERA INFERIOR-RAD. A TUBO	21891
TERMOSTATO-190°	33579	MANGUERA SILICÓN-RAD. A TUBO	SIH250363C
TERMOSTATO-180°	33576	MANGUERA INFERIOR-MOTOR A TUBO	21135
TERMOSTATO-180°	33578	MANGUERA SILICÓN-MOTOR A TUBO	SIH250363C
TERMOSTATO-170°	33577	BANDA-ALT-VENT	K080806
2002		TENSOR-ALT-VENT	38622
BANDA-VENT-AA	K060483	POLEA DEL TENSOR-	36091
POLEA DEL TENSOR-VENT-AA	36091	CATERPILLAR C13 DIESEL	
TENSOR-VENT-AA	38507	2007	
MANGUERA INFERIOR-TUBO A RAD.	21891	POLEA-MOTOR	36093
MANGUERA SILICÓN-TUBO A RAD.	SIH250363C	TERMOSTATO-190°	33579
MANGUERA SILICÓN-MOTOR A TUBO	SIH250363C	TERMOSTATO-180°	33576
MANGUERA SUPERIOR-MOTOR A TUBO	21135	TERMOSTATO-180°	33578



TERMOSTATO-170°	33577	MANGUERA SILICÓN-RAD. A TUBO	SIH250363C
2006		MANGUERA SILICÓN-MOTOR A TUBO	SIH250363C
MANGUERA INFERIOR-RAD. A TUBO	21894	BANDA-ALT-VENT-AA	K081092
MANGUERA SILICÓN-RAD. A TUBO	SIH250363C	TENSOR-ALT-VENT-AA	38590
MANGUERA SILICÓN-MOTOR A TUBO	SIH250363C	TERMOSTATO-190°	33579
POLEA-MOTOR	36093	TERMOSTATO-180°	33576
BANDA-ALT-VENT-AA	K081092	TERMOSTATO-180°	33578
TENSOR-ALT-VENT-AA	38590	TERMOSTATO-170°	33577
TERMOSTATO-190°	33579		
TERMOSTATO-180°	33576		
TERMOSTATO-180°	33578		
TERMOSTATO-170°	33577		
2005			
MANGUERA SILICÓN-TUBO A ENFRIADOR	SIH250363C		
MANGUERA INFERIOR-RAD. A TUBO	21891		
MANGUERA SILICÓN-RAD. A TUBO	SIH250363C		
MANGUERA SILICÓN-MOTOR A TUBO	SIH250363C		
POLEA-MOTOR	36093		
MANGUERA INFERIOR-ENFRIADOR A TUBO	21891		
BANDA-ALT-VENT-AA	K081092		
TENSOR-ALT-VENT-AA	38590		
TERMOSTATO-190°	33579		
TERMOSTATO-180°	33576		
TERMOSTATO-180°	33578		
TERMOSTATO-170°	33577		
CATERPILLAR C11 DIESEL			
2007			
TERMOSTATO-190°	33579		
TERMOSTATO-180°	33576		
TERMOSTATO-180°	33578		
TERMOSTATO-170°	33577		
2006			
MANGUERA INFERIOR-RAD. A TUBO	21894		
MANGUERA SILICÓN-RAD. A TUBO	SIH250363C		
MANGUERA SILICÓN-MOTOR A TUBO	SIH250363C		
BANDA-ALT-VENT-AA	K081092		
TENSOR-ALT-VENT-AA	38590		
TERMOSTATO-190°	33579		
TERMOSTATO-180°	33576		
TERMOSTATO-180°	33578		
TERMOSTATO-170°	33577		
2005			
MANGUERA INFERIOR-RAD. A TUBO	21891		

8100

INTERNATIONAL/NAVISTAR DT466

2003

TERMOSTATO-190° 33179

TERMOSTATO-190° 33957

TERMOSTATO-180° 33118

2002

TERMOSTATO-190° 33179

TERMOSTATO-190° 33957

TERMOSTATO-180° 33118

2001

TERMOSTATO-190° 33179

TERMOSTATO-190° 33957

TERMOSTATO-180° 33118

2000

BANDA-ALT-VENT K080774

POLEA-ALT-VENT 36091

TENSOR-ALT-VENT 38514

BANDA-AA K060470

TENSOR-AA 38511

TERMOSTATO-190° 33179

TERMOSTATO-190° 33957

TERMOSTATO-180° 33118

POLEA DEL TENSOR- 36091

1999

BANDA-ALT-VENT K080774

POLEA-ALT-VENT 36091

TENSOR-ALT-VENT 38514

BANDA-AA K060470

TENSOR-AA 38511

TERMOSTATO-190° 33179

TERMOSTATO-190° 33957

TERMOSTATO-180° 33118

POLEA DEL TENSOR- 36091

1998



MASTER SERVICIO PESADO 2014

INTERNATIONAL/
NAVISTAR
8100

BANDA-ALT-VENT	K080774	POLEA-ALT-VENT	36091
POLEA-ALT-VENT	36091	TENSOR-ALT-VENT	38514
TENSOR-ALT-VENT	38514	BANDA-AA	K060470
BANDA-AA	K060470	TENSOR-AA	38511
TENSOR-AA	38511	TERMOSTATO-190°	33179
TERMOSTATO-190°	33179	TERMOSTATO-190°	33957
TERMOSTATO-190°	33957	TERMOSTATO-180°	33118
TERMOSTATO-180°	33118	MANGUERA DE AGUA-	30T 3/4"
POLEA DEL TENSOR-	36091	MANGUERA DE CALEFACCIÓN-	35B 3/8"
1997		POLEA DEL TENSOR-	36091
MANGUERA SUPERIOR-MOTOR A TUBO	24436	INTERNATIONAL/NAVISTAR 530 DIESEL	
BANDA-ALT-VENT	K080774	2003	
POLEA-ALT-VENT	36091	BANDA-VENT-AA	K060478
TENSOR-ALT-VENT	38514	POLEA DEL TENSOR-VENT-AA	36091
BANDA-ALT	K080730	TENSOR-VENT-AA	38512
BANDA-ALT	K080745	MANGUERA INFERIOR-TUBO A RAD.	21891
BANDA-AA	K060470	MANGUERA SUPERIOR-TUBO A RAD.	21135
TENSOR-AA	38511	BANDA-TOMA DE FUERZA-ALT-VENT	K080760
TERMOSTATO-190°	33179	POLEA DEL TENSOR-TOMA DE FUERZA-ALT-VENT	36091
TERMOSTATO-190°	33957	TENSOR-TOMA DE FUERZA-ALT-VENT	38514
TERMOSTATO-180°	33118	MANGUERA INFERIOR-MOTOR A TUBO	21891
POLEA DEL TENSOR-	36091	MANGUERA SILICÓN-MOTOR A TUBO	SIH250363C
1996		2002	
MANGUERA SUPERIOR-MOTOR A TUBO	24436	BANDA-VENT-AA	K060478
BANDA-ALT-VENT	K080774	POLEA DEL TENSOR-VENT-AA	36091
POLEA-ALT-VENT	36091	TENSOR-VENT-AA	38512
TENSOR-ALT-VENT	38514	MANGUERA INFERIOR-TUBO A RAD.	21891
BANDA-ALT	K080730	MANGUERA SUPERIOR-TUBO A RAD.	21135
BANDA-ALT	K080745	BANDA-TOMA DE FUERZA-ALT-VENT	K080760
BANDA-AA	K060470	POLEA DEL TENSOR-TOMA DE FUERZA-ALT-VENT	36091
TENSOR-AA	38511	TENSOR-TOMA DE FUERZA-ALT-VENT	38514
TERMOSTATO-190°	33179	MANGUERA INFERIOR-MOTOR A TUBO	21891
TERMOSTATO-190°	33957	MANGUERA SILICÓN-MOTOR A TUBO	SIH250363C
TERMOSTATO-180°	33118	2001	
POLEA DEL TENSOR-	36091	BANDA-VENT-AA	K060478
1995		POLEA DEL TENSOR-VENT-AA	36091
MANGUERA INFERIOR-RAD. A TUBO	20987	TENSOR-VENT-AA	38512
MANGUERA SILICÓN-RAD. A TUBO	SIH250363C	MANGUERA INFERIOR-TUBO A RAD.	21891
MANGUERA SILICÓN-MOTOR A TUBO	SIH250363C	MANGUERA SUPERIOR-TUBO A RAD.	21135
MANGUERA SUPERIOR-MOTOR A TUBO	24436	BANDA-TOMA DE FUERZA-ALT-VENT	K080760
MANGUERA SUPERIOR-MOTOR A RAD.	22101	POLEA DEL TENSOR-TOMA DE FUERZA-ALT-VENT	36091
BANDA-ALT-VENT	K080730	TENSOR-TOMA DE FUERZA-ALT-VENT	38514
BANDA-ALT-VENT	K080745	MANGUERA INFERIOR-MOTOR A TUBO	21891



MANGUERA SILICÓN-MOTOR A TUBO	SIH250363C	BANDA-TOMA DE FUERZA-ALT-VENT	K080720
2000		BANDA-TOMA DE FUERZA-ALT-VENT	K080730
BANDA-VENT-AA	K060478	BANDA-TOMA DE FUERZA-ALT-VENT	K080760
POLEA DEL TENSOR-VENT-AA	36091	POLEA DEL TENSOR-TOMA DE FUERZA-ALT-VENT	36091
TENSOR-VENT-AA	38512	TENSOR-TOMA DE FUERZA-ALT-VENT	38514
MANGUERA INFERIOR-TUBO A RAD.	21891	MANGUERA SILICÓN-MOTOR A TUBO	SIH250363C
MANGUERA SUPERIOR-TUBO A RAD.	21135	MANGUERA SUPERIOR-MOTOR A TUBO	24436
BANDA-TOMA DE FUERZA-ALT-VENT	K080760	BANDA-AA	K060470
POLEA DEL TENSOR-TOMA DE FUERZA-ALT-VENT	36091	TENSOR-AA	38511
TENSOR-TOMA DE FUERZA-ALT-VENT	38514	POLEA DEL TENSOR-	36091
MANGUERA INFERIOR-MOTOR A TUBO	21891	1995	
MANGUERA SILICÓN-MOTOR A TUBO	SIH250363C	MANGUERA SILICÓN-TUBO A RAD.	SIH250363C
1999		BANDA-TOMA DE FUERZA-ALT-VENT	K080730
BANDA-VENT-AA	K060478	BANDA-TOMA DE FUERZA-ALT-VENT	K080745
POLEA DEL TENSOR-VENT-AA	36091	POLEA DEL TENSOR-TOMA DE FUERZA-ALT-VENT	36091
TENSOR-VENT-AA	38512	TENSOR-TOMA DE FUERZA-ALT-VENT	38511
MANGUERA INFERIOR-TUBO A RAD.	21891	MANGUERA SILICÓN-MOTOR A TUBO	SIH250363C
MANGUERA SUPERIOR-TUBO A RAD.	21135	MANGUERA SUPERIOR-MOTOR A TUBO	24436
BANDA-TOMA DE FUERZA-ALT-VENT	K080760	BANDA-AA	K060470
POLEA DEL TENSOR-TOMA DE FUERZA-ALT-VENT	36091	TENSOR-AA	38511
TENSOR-TOMA DE FUERZA-ALT-VENT	38514	POLEA DEL TENSOR-	36091
MANGUERA INFERIOR-MOTOR A TUBO	21891	DETROIT DIESEL SERIES 50 DIESEL	
MANGUERA SUPERIOR-MOTOR A TUBO	24436	1998	
1998		TERMOSTATO-190°	33599
BANDA-TOMA DE FUERZA-ALT-VENT	K080760	1997	
POLEA DEL TENSOR-TOMA DE FUERZA-ALT-VENT	36091	TERMOSTATO-190°	33599
TENSOR-TOMA DE FUERZA-ALT-VENT	38514	1996	
BANDA-AA	K060470	TERMOSTATO-190°	33599
TENSOR-AA	38511	1995	
1997		TERMOSTATO-190°	33599
MANGUERA SILICÓN-TUBO A RAD.	SIH250363C	DETROIT DIESEL 6 CIL, 12.7 L DIESEL	
BANDA-TOMA DE FUERZA-ALT-VENT	K080720	1996	
BANDA-TOMA DE FUERZA-ALT-VENT	K080730	TERMOSTATO-190°	33599
BANDA-TOMA DE FUERZA-ALT-VENT	K080760	DETROIT DIESEL 6 CIL, 11.1 L DIESEL	
POLEA DEL TENSOR-TOMA DE FUERZA-ALT-VENT	36091	1996	
TENSOR-TOMA DE FUERZA-ALT-VENT	38514	TERMOSTATO-190°	33599
MANGUERA SILICÓN-MOTOR A TUBO	SIH250363C	CUMMINS N14 DIESEL	
MANGUERA SUPERIOR-MOTOR A TUBO	24436	1999	
BANDA-AA	K060470	BANDA-VENT- OPCIONAL	TR28473
TENSOR-AA	38511	BANDA-VENT	2/TR28473PB
POLEA DEL TENSOR-	36091	BANDA-VENT	TR28522
1996		BANDA-BA	K060425
MANGUERA SILICÓN-TUBO A RAD.	SIH250363C	BANDA-BA	K060435
		BANDA-ALT	2/9463PB



MASTER SERVICIO PESADO 2014

INTERNATIONAL/
NAVISTAR
8100

BANDA-ALT	9440	BANDA-VENT-C/VENT CLUTCH BENDIX	TR28522
BANDA-ALT	9463	MANGUERA INFERIOR-TUBO A RAD.	21891
TERMOSTATO-190°	33579	MANGUERA SILICÓN-TUBO A RAD.	SIH250363C
TERMOSTATO-180°	33576	MANGUERA SILICÓN-MOTOR A TUBO	SIH250363C
TERMOSTATO-180°	33578	MANGUERA SUPERIOR-MOTOR A TUBO	24436
TERMOSTATO-170°	33577	BANDA-C/COMP EATON	9430
BANDA-	9405	BANDA-BA	K040425
1998		BANDA-BA	K060435
BANDA-VENT- OPCIONAL	TR28473	BANDA-ALT-AA	TR22358
BANDA-VENT	2/TR28473PB	BANDA-ALT	9447
BANDA-VENT	TR28522	TERMOSTATO-190°	33579
MANGUERA SILICÓN-TUBO A RAD.	SIH250363C	TERMOSTATO-180°	33576
MANGUERA SILICÓN-MOTOR A TUBO	SIH250363C	TERMOSTATO-180°	33578
BANDA-BA	K060425	TERMOSTATO-170°	33577
BANDA-BA	K060435	1995	
BANDA-ALT	2/9463PB	BANDA-VENT-CON VENT HORTON, SCHWITZER	2/TR28473PB
BANDA-ALT	9440	BANDA-VENT-C/VENT CLUTCH KYSOR	TR28514
BANDA-ALT	9463	BANDA-VENT-C/VENT CLUTCH KYSOR	TR28522
TERMOSTATO-190°	33579	BANDA-VENT-C/VENT CLUTCH HORTON	2/TR28480PB
TERMOSTATO-180°	33576	BANDA-VENT-C/VENT CLUTCH BENDIX	TR28545
TERMOSTATO-180°	33578	BANDA-VENT- OPCIONAL	TR28473
TERMOSTATO-170°	33577	BANDA-VENT- OPCIONAL	TR28480
BANDA-	9405	MANGUERA INFERIOR-TUBO A RAD.	21891
1997		MANGUERA SILICÓN-TUBO A RAD.	SIH250363C
BANDA-VENT- OPCIONAL	TR28473	MANGUERA SILICÓN-MOTOR A TUBO	SIH250363C
BANDA-VENT	2/TR28473PB	MANGUERA SUPERIOR-MOTOR A TUBO	24436
MANGUERA SILICÓN-TUBO A RAD.	SIH250363C	BANDA-C/COMP EATON	9430
MANGUERA SILICÓN-MOTOR A TUBO	SIH250363C	BANDA-BA	K040425
BANDA-BA	K040425	BANDA-BA	K060435
BANDA-BA	K060435	BANDA-ALT-AA	TR22358
BANDA-ALT	9447	BANDA-ALT	9447
TERMOSTATO-190°	33579	TERMOSTATO-190°	33579
TERMOSTATO-180°	33576	TERMOSTATO-180°	33576
TERMOSTATO-180°	33578	TERMOSTATO-180°	33578
TERMOSTATO-170°	33577	TERMOSTATO-170°	33577
BANDA-	9405	CUMMINS M11 DIESEL	
1996		1997	
BANDA-VENT-C/VENT HORTON	TR28522	BANDA-VENT	K080605
BANDA-VENT-C/VENT CLUTCH KYSOR	TR28514	MANGUERA SILICÓN-TUBO A TUBO	SIH250363C
BANDA-VENT-C/VENT CLUTCH KYSOR	TR28522	MANGUERA INFERIOR-TUBO A RAD.	21135
BANDA-VENT-C/VENT CLUTCH HORTON, S/COMP	TR28510	MANGUERA SUPERIOR-TUBO A RAD.	21135
BANDA-VENT-C/VENT CLUTCH HORTON, C/BORG WARNER COMP	TR28501	MANGUERA INFERIOR-MOTOR A TUBO	24438
BANDA-VENT-C/VENT CLUTCH HORTON	TR28522	MANGUERA SUPERIOR-MOTOR A TUBO	24436



MASTER SERVICIO PESADO 2014

INTERNATIONAL/
NAVISTAR
8100

BANDA-ALT	K050336	TERMOSTATO-175°	33960
TERMOSTATO-190°	33579	TERMOSTATO-170°	33577
TERMOSTATO-180°	33576	1997	
TERMOSTATO-180°	33578	BANDA-VENT	K080605
TERMOSTATO-170°	33577	MANGUERA SILICÓN-TUBO A RAD.	SIH250363C
BANDA-	TR22485	MANGUERA SILICÓN-MOTOR A TUBO	SIH250363C
MANGUERA DE AGUA-	30T 3/4"	MANGUERA SUPERIOR-MOTOR A TUBO	24436
MANGUERA DE AGUA-	30T 5/8"	BANDA-ALT	K050323
1996		TERMOSTATO-190°	33579
BANDA-VENT	K080605	TERMOSTATO-180°	33576
MANGUERA SILICÓN-TUBO A TUBO	SIH250363C	TERMOSTATO-180°	33578
MANGUERA INFERIOR-TUBO A RAD.	21135	TERMOSTATO-175°	33960
MANGUERA SUPERIOR-TUBO A RAD.	21135	TERMOSTATO-170°	33577
MANGUERA INFERIOR-MOTOR A TUBO	24438	BANDA-	TR22485
MANGUERA SUPERIOR-MOTOR A TUBO	24436	1996	
BANDA-ALT	K050336	BANDA-VENT	K080496
TERMOSTATO-190°	33579	MANGUERA SILICÓN-RAD. A TUBO	SIH250363C
TERMOSTATO-180°	33576	MANGUERA SUPERIOR-RAD. A TUBO	24436
TERMOSTATO-180°	33578	MANGUERA SILICÓN-MOTOR A TUBO	SIH250363C
TERMOSTATO-170°	33577	MANGUERA SUPERIOR-MOTOR A TUBO	21372
BANDA-	TR22485	BANDA-ALT	K050336
MANGUERA DE AGUA-	30T 3/4"	TERMOSTATO-190°	33579
MANGUERA DE AGUA-	30T 5/8"	TERMOSTATO-180°	33576
1995		TERMOSTATO-180°	33578
BANDA-VENT	K080605	TERMOSTATO-175°	33960
MANGUERA SILICÓN-TUBO A TUBO	SIH250363C	TERMOSTATO-170°	33577
MANGUERA INFERIOR-TUBO A RAD.	21135	BANDA-	TR22485
MANGUERA SUPERIOR-TUBO A RAD.	21135	1995	
MANGUERA INFERIOR-MOTOR A TUBO	24438	BANDA-VENT	K080496
MANGUERA SUPERIOR-MOTOR A TUBO	24436	MANGUERA SILICÓN-RAD. A TUBO	SIH250363C
BANDA-ALT	K050336	MANGUERA SUPERIOR-RAD. A TUBO	24436
TERMOSTATO-190°	33579	MANGUERA SILICÓN-MOTOR A TUBO	SIH250363C
TERMOSTATO-180°	33576	MANGUERA SUPERIOR-MOTOR A TUBO	21372
TERMOSTATO-180°	33578	BANDA-ALT	K050336
TERMOSTATO-170°	33577	TERMOSTATO-190°	33579
BANDA-	TR22485	TERMOSTATO-180°	33576
MANGUERA DE AGUA-	30T 3/4"	TERMOSTATO-180°	33578
MANGUERA DE AGUA-	30T 5/8"	TERMOSTATO-175°	33960
CUMMINS L10 DIESEL		TERMOSTATO-170°	33577
1998		BANDA-	TR22485
TERMOSTATO-190°	33579	CUMMINS ISM DIESEL	
TERMOSTATO-180°	33576	2003	
TERMOSTATO-180°	33578	BANDA-VENT	K080605



MASTER SERVICIO PESADO 2014

INTERNATIONAL/
NAVISTAR
8100

MANGUERA INFERIOR-TUBO A RAD.	21194	MANGUERA INFERIOR-MOTOR A TUBO	24438
MANGUERA SUPERIOR-TUBO A RAD.	21135	MANGUERA SUPERIOR-MOTOR A TUBO	24436
BANDA-TOMA DE FUERZA-ALT	K050336	BANDA-ALT	K050336
BANDA-TOMA DE FUERZA-AA	TR22485	BANDA-	TR22485
MANGUERA SILICÓN-MOTOR A TUBO	SIH250363C	MANGUERA DE AGUA-	30T 3/4"
2002		MANGUERA DE AGUA-	30T 5/8"
BANDA-VENT	K080605	MANGUERA SUPERIOR-	21135
MANGUERA INFERIOR-TUBO A RAD.	21194	CATERPILLAR C10 DIESEL	
MANGUERA SUPERIOR-TUBO A RAD.	21135	2003	
BANDA-TOMA DE FUERZA-ALT	K050336	BANDA-VENT-AA	K060586
BANDA-TOMA DE FUERZA-AA	TR22485	POLEA DEL TENSOR-VENT-AA	36091
MANGUERA SILICÓN-MOTOR A TUBO	SIH250363C	TENSOR-VENT-AA	38507
2001		MANGUERA INFERIOR-TUBO A RAD.	21891
BANDA-VENT	K080605	MANGUERA SUPERIOR-TUBO A RAD.	21135
MANGUERA INFERIOR-TUBO A RAD.	21135	MANGUERA SILICÓN-MOTOR A TUBO	SIH250363C
MANGUERA SUPERIOR-TUBO A RAD.	21135	MANGUERA SUPERIOR-MOTOR A TUBO	21135
BANDA-TOMA DE FUERZA-ALT	K050336	BANDA-ALT-VENT	K080859
BANDA-TOMA DE FUERZA-AA	TR22485	POLEA-ALT-VENT	36091
MANGUERA SILICÓN-MOTOR A TUBO	SIH250363C	TENSOR-ALT-VENT	38506
2000		TERMOSTATO-190°	33579
BANDA-VENT	K080605	TERMOSTATO-180°	33576
MANGUERA INFERIOR-TUBO A RAD.	21135	TERMOSTATO-180°	33578
MANGUERA SUPERIOR-TUBO A RAD.	21135	TERMOSTATO-170°	33577
BANDA-TOMA DE FUERZA-ALT	K050336	2002	
BANDA-TOMA DE FUERZA-AA	TR22485	BANDA-VENT-AA	K060586
MANGUERA SILICÓN-MOTOR A TUBO	SIH250363C	POLEA DEL TENSOR-VENT-AA	36091
1999		TENSOR-VENT-AA	38507
BANDA-VENT	K080560	MANGUERA INFERIOR-TUBO A RAD.	21891
BANDA-VENT	K080570	MANGUERA SUPERIOR-TUBO A RAD.	21135
BANDA-VENT	K080605	MANGUERA SILICÓN-MOTOR A TUBO	SIH250363C
MANGUERA INFERIOR-TUBO A RAD.	21135	MANGUERA SUPERIOR-MOTOR A TUBO	21135
MANGUERA SUPERIOR-TUBO A RAD.	24436	BANDA-ALT-VENT	K080859
BANDA-TOMA DE FUERZA-ALT	K050336	POLEA-ALT-VENT	36091
BANDA-TOMA DE FUERZA-AA	TR22485	TENSOR-ALT-VENT	38506
MANGUERA SILICÓN-MOTOR A TUBO	SIH250363C	TERMOSTATO-190°	33579
MANGUERA SUPERIOR-MOTOR A TUBO	20748	TERMOSTATO-180°	33576
BANDA-ALT	K050323	TERMOSTATO-180°	33578
BANDA-ALT	K050336	TERMOSTATO-170°	33577
1998		2001	
BANDA-VENT	K080605	MANGUERA INFERIOR-TUBO A RAD.	CHARTER 2 1/2"
MANGUERA SILICÓN-TUBO A TUBO	SIH250363C	MANGUERA SUPERIOR-TUBO A RAD.	CHARTER 2 1/2"
MANGUERA INFERIOR-TUBO A RAD.	21135	MANGUERA INFERIOR-MOTOR A TUBO	21891
MANGUERA SILICÓN-TUBO A RAD.	SIH250363C	MANGUERA SUPERIOR-MOTOR A TUBO	21135



MASTER SERVICIO PESADO 2014

INTERNATIONAL/
NAVISTAR
8100

BANDA-ALT-VENT	K080760	MANGUERA SUPERIOR-MOTOR A TUBO	CHARTER 2 1/2"
TERMOSTATO-190°	33579	BANDA-ALT-VENT	K080760
TERMOSTATO-180°	33576	TERMOSTATO-190°	33579
TERMOSTATO-180°	33578	TERMOSTATO-180°	33576
TERMOSTATO-170°	33577	TERMOSTATO-180°	33578
BANDA-	9447	TERMOSTATO-170°	33577
2000		1996	
MANGUERA INFERIOR-TUBO A RAD.	CHARTER 2 1/2"	TERMOSTATO-190°	33579
MANGUERA SUPERIOR-TUBO A RAD.	21135	TERMOSTATO-180°	33576
MANGUERA INFERIOR-MOTOR A TUBO	21891	TERMOSTATO-180°	33578
MANGUERA SUPERIOR-MOTOR A TUBO	21135	TERMOSTATO-170°	33577
BANDA-ALT-VENT	K080760	CATERPILLAR 3176 DIESEL	
TERMOSTATO-190°	33579	1997	
TERMOSTATO-180°	33576	BANDA-VENT-AA	K080774
TERMOSTATO-180°	33578	MANGUERA INFERIOR-RAD. A TUBO	21115
TERMOSTATO-170°	33577	MANGUERA SUPERIOR-RAD. A TUBO	21135
BANDA-	9447	MANGUERA SILICÓN-MOTOR A TUBO	SIH250363C
1999		MANGUERA INFERIOR-MOTOR A RAD.	21135
TERMOSTATO-190°	33579	BANDA-ALT-VENT-C/VENT CLUTCH SCHWITZER	K080720
TERMOSTATO-180°	33576	BANDA-ALT-VENT-C/VENT CLUTCH HORTON, KYSOR	K080774
TERMOSTATO-180°	33578	BANDA-ALT-VENT-C/VENT CLUTCH BENDIX	K080708
TERMOSTATO-170°	33577	SENSOR-ALT-VENT	38514
1998		TERMOSTATO-190°	33579
MANGUERA INFERIOR-TUBO A RAD.	21891	TERMOSTATO-180°	33576
MANGUERA SUPERIOR-TUBO A RAD.	21135	TERMOSTATO-180°	33578
MANGUERA INFERIOR-MOTOR A TUBO	CHARTER 2 1/2"	TERMOSTATO-170°	33577
MANGUERA SUPERIOR-MOTOR A TUBO	21135	BANDA-	9463
BANDA-ALT-VENT	K080760	POLEA DEL SENSOR-	36091
TERMOSTATO-190°	33579	1996	
TERMOSTATO-180°	33576	BANDA-VENT-AA	K080774
TERMOSTATO-180°	33578	MANGUERA INFERIOR-RAD. A TUBO	21115
TERMOSTATO-170°	33577	MANGUERA SUPERIOR-RAD. A TUBO	21135
BANDA-	9463	MANGUERA SILICÓN-MOTOR A TUBO	SIH250363C
1997		MANGUERA INFERIOR-MOTOR A RAD.	21135
TERMOSTATO-190°	33579	BANDA-ALT-VENT-C/VENT CLUTCH SCHWITZER	K080720
TERMOSTATO-180°	33576	BANDA-ALT-VENT-C/VENT CLUTCH HORTON, KYSOR	K080774
TERMOSTATO-180°	33578	BANDA-ALT-VENT-C/VENT CLUTCH BENDIX	K080708
TERMOSTATO-170°	33577	SENSOR-ALT-VENT	38514
CATERPILLAR 3406 DIESEL		TERMOSTATO-190°	33579
1998		TERMOSTATO-180°	33576
MANGUERA INFERIOR-TUBO A RAD.	CHARTER 2 1/2"	TERMOSTATO-180°	33578
MANGUERA SUPERIOR-TUBO A MOTOR	21135	TERMOSTATO-170°	33577
MANGUERA INFERIOR-MOTOR A TUBO	21897	BANDA-	9463



POLEA DEL TENSOR-	36091	1996	MANGUERA SILICÓN-TUBO A RAD.	SIH250363C
1995				
BANDA-VENT-AA	K080774		BANDA-TOMA DE FUERZA-ALT-VENT	K080720
BANDA-ALT-VENT-C/VENT CLUTCH SCHWITZER	K080720		BANDA-TOMA DE FUERZA-ALT-VENT	K080730
BANDA-ALT-VENT-C/VENT CLUTCH HORTON, KYSOR	K080774		BANDA-TOMA DE FUERZA-ALT-VENT	K080760
BANDA-ALT-VENT-C/VENT CLUTCH BENDIX	K080708		POLEA DEL TENSOR-TOMA DE FUERZA-ALT-VENT	36091
POLEA-ALT-VENT	36091		TENSOR-TOMA DE FUERZA-ALT-VENT	38514
TENSOR-ALT-VENT	38514		MANGUERA SILICÓN-MOTOR A TUBO	SIH250363C
TERMOSTATO-190°	33579		MANGUERA SUPERIOR-MOTOR A TUBO	24436
TERMOSTATO-180°	33576		BANDA-AA	K060470
TERMOSTATO-180°	33578		TENSOR-AA	38511
TERMOSTATO-170°	33577		POLEA DEL TENSOR-	36091
BANDA-	9463			

8200

INTERNATIONAL/NAVISTAR DT466

1997				
MANGUERA SILICÓN-TUBO A RAD.	SIH250363C			
POLEA DEL TENSOR-TOMA DE FUERZA-ALT-VENT	36091			
TENSOR-TOMA DE FUERZA-ALT-VENT	38514			
MANGUERA SILICÓN-MOTOR A TUBO	SIH250363C			
MANGUERA SUPERIOR-MOTOR A TUBO	24436			
BANDA-MOTOR	K080720			
BANDA-MOTOR	K080730			
BANDA-MOTOR	K080760			
BANDA-AA	K060470			
TENSOR-AA	38511			
TERMOSTATO-190°	33179			
TERMOSTATO-190°	33957			
TERMOSTATO-180°	33118			
POLEA DEL TENSOR-	36091			

INTERNATIONAL/NAVISTAR 530 DIESEL

1997				
MANGUERA SILICÓN-TUBO A RAD.	SIH250363C			
BANDA-TOMA DE FUERZA-ALT-VENT	K080720			
BANDA-TOMA DE FUERZA-ALT-VENT	K080730			
BANDA-TOMA DE FUERZA-ALT-VENT	K080760			
POLEA DEL TENSOR-TOMA DE FUERZA-ALT-VENT	36091			
TENSOR-TOMA DE FUERZA-ALT-VENT	38514			
MANGUERA SILICÓN-MOTOR A TUBO	SIH250363C			
MANGUERA SUPERIOR-MOTOR A TUBO	24436			
BANDA-AA	K060470			
TENSOR-AA	38511			
POLEA DEL TENSOR-	36091			

DETROIT DIESEL SERIES 50 DIESEL

1997				
TERMOSTATO-190°			33599	

DETROIT DIESEL SERIE 60

1998				
TERMOSTATO-190°			33599	
1997				
TERMOSTATO-190°			33599	

DETROIT DIESEL 6 CIL, 12.7 L DIESEL

1996				
TERMOSTATO-190°			33599	
1995				
BANDA-VENT			K100640	
POLEA DEL TENSOR-VENT			36091	
TENSOR-VENT			38511	
MANGUERA SILICÓN-TUBO A RAD.			SIH250363C	
MANGUERA INFERIOR-MOTOR A TUBO			21891	
MANGUERA SILICÓN-MOTOR A TUBO			SIH250363C	
BANDA-ALT			2/9313PB	
BANDA-ALT			9313	
BANDA-AA			K060500	
TERMOSTATO-190°			33599	

DETROIT DIESEL 6 CIL, 11.1 L DIESEL

1996				
TERMOSTATO-190°			33599	
1995				
BANDA-VENT			K100640	
POLEA DEL TENSOR-VENT			36091	
TENSOR-VENT			38511	
MANGUERA SILICÓN-TUBO A RAD.			SIH250363C	
MANGUERA INFERIOR-MOTOR A TUBO			21891	
MANGUERA SILICÓN-MOTOR A TUBO			SIH250363C	



BANDA-ALT	2/9313PB	BANDA-C/COMP EATON	9430
BANDA-ALT	9313	BANDA-BA	K040425
BANDA-AA	K060520	BANDA-BA	K060435
TERMOSTATO-190°	33599	BANDA-ALT-AA	TR22358
CUMMINS N14 DIESEL		BANDA-ALT	9447
1998		TERMOSTATO-190°	33579
BANDA-VENT- OPCIONAL	TR28473	TERMOSTATO-180°	33576
BANDA-VENT	2/TR28473PB	TERMOSTATO-180°	33578
MANGUERA SILICÓN-TUBO A RAD.	SIH250363C	TERMOSTATO-170°	33577
MANGUERA SILICÓN-MOTOR A TUBO	SIH250363C	1995	
BANDA-BA	K040425	BANDA-VENT-CON VENT HORTON, SCHWITZER	2/TR28473PB
BANDA-BA	K060435	BANDA-VENT-C/VENT CLUTCH KYSOR	TR28514
BANDA-ALT	9447	BANDA-VENT-C/VENT CLUTCH KYSOR	TR28522
TERMOSTATO-190°	33579	BANDA-VENT-C/VENT CLUTCH HORTON	2/TR28480PB
TERMOSTATO-180°	33576	BANDA-VENT-C/VENT CLUTCH BENDIX	TR28545
TERMOSTATO-180°	33578	BANDA-VENT- OPCIONAL	TR28473
TERMOSTATO-170°	33577	BANDA-VENT- OPCIONAL	TR28480
BANDA-	9405	MANGUERA INFERIOR-TUBO A RAD.	21891
1997		MANGUERA SILICÓN-TUBO A RAD.	SIH250363C
BANDA-VENT- OPCIONAL	TR28473	MANGUERA SILICÓN-MOTOR A TUBO	SIH250363C
BANDA-VENT	2/TR28473PB	MANGUERA SUPERIOR-MOTOR A TUBO	24436
MANGUERA SILICÓN-TUBO A RAD.	SIH250363C	BANDA-C/COMP EATON	9430
MANGUERA SILICÓN-MOTOR A TUBO	SIH250363C	BANDA-BA	K040425
BANDA-BA	K040425	BANDA-BA	K060435
BANDA-BA	K060435	BANDA-ALT-AA	TR22358
BANDA-ALT	9447	BANDA-ALT	9447
TERMOSTATO-190°	33579	TERMOSTATO-190°	33579
TERMOSTATO-180°	33576	TERMOSTATO-180°	33576
TERMOSTATO-180°	33578	TERMOSTATO-180°	33578
TERMOSTATO-170°	33577	TERMOSTATO-170°	33577
BANDA-	9405	CUMMINS M11 DIESEL	
1996		1997	
BANDA-VENT-C/VENT HORTON	TR28522	BANDA-VENT	K080605
BANDA-VENT-C/VENT CLUTCH KYSOR	TR28514	MANGUERA INFERIOR-TUBO A RAD.	21135
BANDA-VENT-C/VENT CLUTCH KYSOR	TR28522	MANGUERA SUPERIOR-TUBO A RAD.	21135
BANDA-VENT-C/VENT CLUTCH HORTON, S/COMP	TR28510	MANGUERA SILICÓN-MOTOR A TUBO	SIH250363C
BANDA-VENT-C/VENT CLUTCH HORTON, C/BORG WARNER COMP	TR28501	MANGUERA SUPERIOR-MOTOR A TUBO	24436
BANDA-VENT-C/VENT CLUTCH HORTON	TR28522	BANDA-ALT	K050336
BANDA-VENT-C/VENT CLUTCH BENDIX	TR28522	TERMOSTATO-190°	33579
MANGUERA INFERIOR-TUBO A RAD.	21891	TERMOSTATO-180°	33576
MANGUERA SILICÓN-TUBO A RAD.	SIH250363C	TERMOSTATO-180°	33578
MANGUERA SILICÓN-MOTOR A TUBO	SIH250363C	TERMOSTATO-170°	33577
MANGUERA SUPERIOR-MOTOR A TUBO	24436	BANDA-	TR22485



MASTER SERVICIO PESADO 2014

INTERNATIONAL/
NAVISTAR
8200

1996

BANDA-VENT	K080605	BANDA-VENT	K080570
MANGUERA SILICÓN-TUBO A TUBO	SIH250363C	MANGUERA SILICÓN-TUBO A RAD.	SIH250363C
MANGUERA INFERIOR-TUBO A RAD.	21135	MANGUERA SILICÓN-MOTOR A TUBO	SIH250363C
MANGUERA SUPERIOR-TUBO A RAD.	21135	MANGUERA SUPERIOR-MOTOR A TUBO	24436
MANGUERA SILICÓN-MOTOR A TUBO	SIH250363C	BANDA-ALT	K050336
BANDA-ALT	K050336	TERMOSTATO-190°	33579
TERMOSTATO-190°	33579	TERMOSTATO-180°	33576
TERMOSTATO-180°	33576	TERMOSTATO-180°	33578
TERMOSTATO-180°	33578	TERMOSTATO-175°	33960
TERMOSTATO-170°	33577	TERMOSTATO-170°	33577
BANDA-	TR22485	BANDA-	TR22485
MANGUERA DE AGUA-	30T 3/4"		
MANGUERA DE AGUA-	30T 5/8"		

1995

BANDA-VENT	K080605	BANDA-VENT	K080570
MANGUERA SILICÓN-TUBO A TUBO	SIH250363C	MANGUERA SILICÓN-TUBO A RAD.	SIH250363C
MANGUERA INFERIOR-TUBO A RAD.	21135	MANGUERA SILICÓN-MOTOR A TUBO	SIH250363C
MANGUERA SUPERIOR-TUBO A RAD.	21135	MANGUERA SUPERIOR-MOTOR A TUBO	24436
MANGUERA INFERIOR-MOTOR A TUBO	24438	BANDA-ALT	K050336
MANGUERA SUPERIOR-MOTOR A TUBO	24436	TERMOSTATO-190°	33579
BANDA-ALT	K050336	TERMOSTATO-180°	33576
TERMOSTATO-190°	33579	TERMOSTATO-180°	33578
TERMOSTATO-180°	33576	TERMOSTATO-180°	33578
TERMOSTATO-180°	33578	TERMOSTATO-175°	33960
TERMOSTATO-170°	33577	TERMOSTATO-170°	33577
BANDA-	TR22485	BANDA-	TR22485
MANGUERA DE AGUA-	30T 3/4"		
MANGUERA DE AGUA-	30T 5/8"		

CUMMINS L10 DIESEL

1997

BANDA-VENT	K080570	BANDA-VENT	K080570
MANGUERA SILICÓN-TUBO A RAD.	SIH250363C	MANGUERA SILICÓN-TUBO A RAD.	SIH250363C
MANGUERA SILICÓN-MOTOR A TUBO	SIH250363C	MANGUERA SILICÓN-MOTOR A TUBO	SIH250363C
MANGUERA SUPERIOR-MOTOR A TUBO	24436	MANGUERA SUPERIOR-MOTOR A TUBO	24436
BANDA-ALT	K050336	BANDA-ALT	K050336
TERMOSTATO-190°	33579	BANDA-	TR22485
TERMOSTATO-180°	33576		
TERMOSTATO-180°	33578		
TERMOSTATO-175°	33960		
TERMOSTATO-170°	33577		
BANDA-	TR22485		

1996

BANDA-VENT	K080570		
MANGUERA SILICÓN-TUBO A RAD.	SIH250363C		
MANGUERA SILICÓN-MOTOR A TUBO	SIH250363C		
MANGUERA SUPERIOR-MOTOR A TUBO	24436		
BANDA-ALT	K050336		
TERMOSTATO-190°	33579		
TERMOSTATO-180°	33576		
TERMOSTATO-180°	33578		
TERMOSTATO-175°	33960		
TERMOSTATO-170°	33577		
BANDA-	TR22485		
MANGUERA DE AGUA-	30T 3/4"		
MANGUERA DE AGUA-	30T 5/8"		

CUMMINS ISM DIESEL

1998

BANDA-VENT	K080605	BANDA-VENT	K080605
MANGUERA INFERIOR-TUBO A RAD.	21135	MANGUERA INFERIOR-TUBO A RAD.	21135
MANGUERA SUPERIOR-TUBO A RAD.	21135	MANGUERA SUPERIOR-TUBO A RAD.	21135
MANGUERA SILICÓN-MOTOR A TUBO	SIH250363C	MANGUERA SILICÓN-MOTOR A TUBO	SIH250363C
MANGUERA SUPERIOR-MOTOR A TUBO	24436	MANGUERA SUPERIOR-MOTOR A TUBO	24436
BANDA-ALT	K050336	BANDA-ALT	K050336
BANDA-	TR22485	BANDA-	TR22485

CATERPILLAR C12 DIESEL

1997

TERMOSTATO-190°	33579	TERMOSTATO-190°	33579
TERMOSTATO-180°	33576	TERMOSTATO-180°	33576
TERMOSTATO-180°	33578	TERMOSTATO-180°	33578
TERMOSTATO-170°	33577	TERMOSTATO-170°	33577

CATERPILLAR C10 DIESEL

1998

TERMOSTATO-190°	33579	TERMOSTATO-190°	33579
TERMOSTATO-180°	33576	TERMOSTATO-180°	33576
TERMOSTATO-180°	33578	TERMOSTATO-180°	33578



TERMOSTATO-170°	33577		8500
1997			
TERMOSTATO-190°	33579	INTERNATIONAL/NAVISTAR HT570 DIESEL	
TERMOSTATO-180°	33576	2007	
TERMOSTATO-180°	33578	MANGUERA SUPERIOR-MOTOR A RAD.	21115
TERMOSTATO-170°	33577	TENSOR-ALT-VENT-AA	38620
CATERPILLAR 3406 DIESEL		2005	
1998		TENSOR-ALT-VENT-AA	38620
TERMOSTATO-190°	33579	INTERNATIONAL/NAVISTAR DT570 DIESEL	
TERMOSTATO-180°	33576	2006	
TERMOSTATO-180°	33578	MANGUERA SUPERIOR-MOTOR A RAD.	21115
TERMOSTATO-170°	33577	TENSOR-ALT-VENT-AA	38620
1997		2005	
TERMOSTATO-190°	33579	BANDA-ALT-BA-VENT	K080922
TERMOSTATO-180°	33576	INTERNATIONAL/NAVISTAR DT466	
TERMOSTATO-180°	33578	2002	
TERMOSTATO-170°	33577	TERMOSTATO-190°	33179
1996		TERMOSTATO-190°	33957
TERMOSTATO-190°	33579	TERMOSTATO-180°	33118
TERMOSTATO-180°	33576	INTERNATIONAL/NAVISTAR 530 DIESEL	
TERMOSTATO-180°	33578	2005	
TERMOSTATO-170°	33577	BANDA-VENT-AA	K060490
1995		POLEA DEL TENSOR-VENT-AA	36091
TERMOSTATO-190°	33579	TENSOR-VENT-AA	38511
TERMOSTATO-180°	33576	BANDA-ALT-VENT	K080685
TERMOSTATO-180°	33578	POLEA-ALT-VENT	36091
TERMOSTATO-170°	33577	TENSOR-ALT-VENT	38514
CATERPILLAR 3176 DIESEL		2004	
1997		BANDA-VENT-AA	K060490
TERMOSTATO-190°	33579	POLEA DEL TENSOR-VENT-AA	36091
TERMOSTATO-180°	33576	TENSOR-VENT-AA	38511
TERMOSTATO-180°	33578	BANDA-ALT-VENT	K080685
TERMOSTATO-170°	33577	POLEA-ALT-VENT	36091
1996		TENSOR-ALT-VENT	38514
TERMOSTATO-190°	33579	2003	
TERMOSTATO-180°	33576	BANDA-VENT-AA	K060490
TERMOSTATO-180°	33578	POLEA DEL TENSOR-VENT-AA	36091
TERMOSTATO-170°	33577	TENSOR-VENT-AA	38511
1995		BANDA-ALT-VENT	K080685
TERMOSTATO-190°	33579	POLEA-ALT-VENT	36091
TERMOSTATO-180°	33576	TENSOR-ALT-VENT	38514
TERMOSTATO-180°	33578	2002	
TERMOSTATO-170°	33577	BANDA-VENT-AA	K060490
		POLEA DEL TENSOR-VENT-AA	36091
		TENSOR-VENT-AA	38511



MASTER SERVICIO PESADO 2014

INTERNATIONAL/
NAVISTAR
8500

BANDA-ALT-VENT	K080685	POLEA DEL TENSOR-	36091
POLEA-ALT-VENT	36091	2003	
TENSOR-ALT-VENT	38514	MANGUERA INFERIOR-TUBO A RAD.	21891
8600		MANGUERA SILICÓN-TUBO A RAD.	SIH250363C
INTERNATIONAL/NAVISTAR HT570 DIESEL			
2005			
TENSOR-ALT-VENT-AA	38620	BANDA-TOMA DE FUERZA-AA	K060516
CUMMINS ISM DIESEL			
2007			
MANGUERA INFERIOR-TUBO A RAD.	21891	TENSOR-TOMA DE FUERZA-AA	38505
MANGUERA SILICÓN-TUBO A RAD.	SIH250363C	MANGUERA SILICÓN-MOTOR A TUBO	SIH250363C
BANDA-TOMA DE FUERZA-AA	K060516	MANGUERA SUPERIOR-MOTOR A TUBO	24436
TENSOR-TOMA DE FUERZA-AA	38505	BANDA-ALT-VENT	K080694
MANGUERA SILICÓN-MOTOR A TUBO	SIH250363C	TENSOR-ALT-VENT	38521
BANDA-ALT-VENT	K080694	POLEA DEL TENSOR-	36091
TENSOR-ALT-VENT	38622	CATERPILLAR C13 DIESEL	
POLEA DEL TENSOR-	36091	2007	
2006			
MANGUERA INFERIOR-TUBO A RAD.	21891	MANGUERA INFERIOR-RAD. A TUBO	21135
MANGUERA SILICÓN-TUBO A RAD.	SIH250363C	MANGUERA SUPERIOR-RAD. A TUBO	21135
BANDA-TOMA DE FUERZA-AA	K060516	MANGUERA INFERIOR-MOTOR A TUBO	21135
TENSOR-TOMA DE FUERZA-AA	38505	MANGUERA SILICÓN-MOTOR A TUBO	SIH250363C
MANGUERA SILICÓN-MOTOR A TUBO	SIH250363C	POLEA-MOTOR	36093
BANDA-ALT-VENT	K080694	BANDA-ALT-VENT-AA	K080944
TENSOR-ALT-VENT	38622	TENSOR-ALT-VENT-AA	38590
POLEA DEL TENSOR-	36091	TERMOSTATO-190°	33579
2005			
MANGUERA INFERIOR-TUBO A RAD.	21891	TERMOSTATO-180°	33576
MANGUERA SILICÓN-TUBO A RAD.	SIH250363C	TERMOSTATO-180°	33578
BANDA-TOMA DE FUERZA-AA	K060516	TERMOSTATO-170°	33577
TENSOR-TOMA DE FUERZA-AA	38505	2006	
MANGUERA SILICÓN-MOTOR A TUBO	SIH250363C	MANGUERA INFERIOR-RAD. A TUBO	21891
BANDA-ALT-VENT	K080694	MANGUERA SILICÓN-RAD. A TUBO	SIH250363C
TENSOR-ALT-VENT	38622	MANGUERA SILICÓN-MOTOR A TUBO	SIH250363C
POLEA DEL TENSOR-	36091	MANGUERA SUPERIOR-MOTOR A TUBO	21135
2005			
MANGUERA INFERIOR-TUBO A RAD.	21891	POLEA-MOTOR	36093
MANGUERA SILICÓN-TUBO A RAD.	SIH250363C	BANDA-ALT-VENT-AA	K080944
BANDA-TOMA DE FUERZA-AA	K060516	TENSOR-ALT-VENT-AA	38590
TENSOR-TOMA DE FUERZA-AA	38505	TERMOSTATO-190°	33579
MANGUERA SILICÓN-MOTOR A TUBO	SIH250363C	TERMOSTATO-180°	33576
BANDA-ALT-VENT	K080694	TERMOSTATO-180°	33578
TENSOR-ALT-VENT	38622	TERMOSTATO-170°	33577
POLEA DEL TENSOR-	36091	2006	
2004			
MANGUERA INFERIOR-TUBO A RAD.	21891	MANGUERA INFERIOR-RAD. A TUBO	21891
MANGUERA SILICÓN-TUBO A RAD.	SIH250363C	MANGUERA SUPERIOR-RAD. A TUBO	21135
BANDA-TOMA DE FUERZA-AA	K060516	MANGUERA SILICÓN-MOTOR A TUBO	SIH250363C
TENSOR-TOMA DE FUERZA-AA	38505	MANGUERA SUPERIOR-MOTOR A TUBO	21135
MANGUERA SILICÓN-MOTOR A TUBO	SIH250363C	POLEA-MOTOR	36093
BANDA-ALT-VENT	K080694	BANDA-ALT-VENT-AA	K080944
TENSOR-ALT-VENT	38521	TENSOR-ALT-VENT-AA	38590
		TERMOSTATO-190°	33579
		TERMOSTATO-180°	33576
		TERMOSTATO-180°	33578
		TERMOSTATO-170°	33577
		2005	
		MANGUERA INFERIOR-RAD. A TUBO	21891
		MANGUERA SUPERIOR-RAD. A TUBO	21135
		MANGUERA SILICÓN-MOTOR A TUBO	SIH250363C
		MANGUERA SUPERIOR-MOTOR A TUBO	21135
		POLEA-MOTOR	36093
		BANDA-ALT-VENT-AA	K080944



MASTER SERVICIO PESADO 2014

INTERNATIONAL/
NAVISTAR
8600

TENSOR-ALT-VENT-AA	38590	TERMOSTATO-180°	33576
TERMOSTATO-190°	33579	TERMOSTATO-180°	33578
TERMOSTATO-180°	33576	TERMOSTATO-170°	33577
TERMOSTATO-180°	33578	2002	
TERMOSTATO-170°	33577	TERMOSTATO-190°	33579
2004		TERMOSTATO-180°	33576
MANGUERA SUPERIOR-RAD. A TUBO	21135	TERMOSTATO-180°	33578
MANGUERA SUPERIOR-MOTOR A TUBO	21135	TERMOSTATO-170°	33577
POLEA-MOTOR	36093	CATERPILLAR C11 DIESEL	
BANDA-ALT-VENT-AA	K080944	2007	
TENSOR-ALT-VENT-AA	38590	MANGUERA INFERIOR-RAD. A TUBO	21135
TERMOSTATO-190°	33579	MANGUERA SUPERIOR-RAD. A TUBO	21135
TERMOSTATO-180°	33576	MANGUERA INFERIOR-MOTOR A TUBO	21135
TERMOSTATO-180°	33578	MANGUERA SILICÓN-MOTOR A TUBO	SIH250363C
TERMOSTATO-170°	33577	BANDA-ALT-VENT-AA	K080944
MANGUERA SILICÓN-	SIH250363C	TENSOR-ALT-VENT-AA	38590
CATERPILLAR C12 DIESEL		TERMOSTATO-190°	33579
2004		TERMOSTATO-180°	33576
BANDA-VENT-AA	K060586	TERMOSTATO-180°	33578
POLEA DEL TENSOR-VENT-AA	36091	TERMOSTATO-170°	33577
TENSOR-VENT-AA	38507	2006	
MANGUERA INFERIOR-TUBO A RAD.	21891	MANGUERA INFERIOR-RAD. A TUBO	21891
MANGUERA SUPERIOR-TUBO A RAD.	21135	MANGUERA SILICÓN-RAD. A TUBO	SIH250363C
MANGUERA SILICÓN-MOTOR A TUBO	SIH250363C	MANGUERA SILICÓN-MOTOR A TUBO	SIH250363C
BANDA-ALT-VENT	K080859	MANGUERA SUPERIOR-MOTOR A TUBO	21135
POLEA-ALT-VENT	36091	BANDA-ALT-VENT-AA	K080944
TENSOR-ALT-VENT	38506	TENSOR-ALT-VENT-AA	38590
TERMOSTATO-190°	33579	TERMOSTATO-190°	33579
TERMOSTATO-180°	33576	TERMOSTATO-180°	33576
TERMOSTATO-180°	33578	TERMOSTATO-180°	33578
TERMOSTATO-170°	33577	TERMOSTATO-170°	33577
2003		2005	
BANDA-VENT-AA	K060586	MANGUERA INFERIOR-RAD. A TUBO	21891
POLEA DEL TENSOR-VENT-AA	36091	MANGUERA SUPERIOR-RAD. A TUBO	21135
TENSOR-VENT-AA	38507	MANGUERA SILICÓN-MOTOR A TUBO	SIH250363C
MANGUERA INFERIOR-TUBO A RAD.	21891	MANGUERA SUPERIOR-MOTOR A TUBO	21135
MANGUERA SUPERIOR-TUBO A RAD.	21135	BANDA-ALT-VENT-AA	K080944
MANGUERA SILICÓN-MOTOR A TUBO	SIH250363C	TENSOR-ALT-VENT-AA	38590
MANGUERA SUPERIOR-MOTOR A TUBO	21135	TERMOSTATO-190°	33579
BANDA-ALT-VENT	K080859	TERMOSTATO-180°	33576
POLEA-ALT-VENT	36091	TERMOSTATO-180°	33578
TENSOR-ALT-VENT	38506	TERMOSTATO-170°	33577
TERMOSTATO-190°	33579	2004	



MASTER SERVICIO PESADO 2014

INTERNATIONAL/
NAVISTAR
8600

MANGUERA SUPERIOR-RAD. A TUBO	21135	TERMOSTATO-170°	33577
MANGUERA SUPERIOR-MOTOR A TUBO	21135	9000	
BANDA-ALT-VENT-AA	K080944	CUMMINS ISX DIESEL	
TENSOR-ALT-VENT-AA	38590	2004	
TERMOSTATO-190°	33579	MANGUERA SUPERIOR-RAD. A TUBO	21135
TERMOSTATO-180°	33576	MANGUERA SUPERIOR-MOTOR A TUBO	21135
TERMOSTATO-180°	33578	BANDA-ALT-VENT	K120979
TERMOSTATO-170°	33577	BANDA-AA	K060637
MANGUERA SILICÓN-	SIH250363C	MANGUERA INFERIOR-	CHARTER 2 1/2"
CATERPILLAR C10 DIESEL		CUMMINS ISM DIESEL	
2004		2004	
BANDA-VENT-AA	K060586	BANDA-VENT	K080740
POLEA DEL TENSOR-VENT-AA	36091	BANDA-TOMA DE FUERZA-AA	K060516
TENSOR-VENT-AA	38507	TENSOR-TOMA DE FUERZA-AA	38521
MANGUERA INFERIOR-TUBO A RAD.	21891	MANGUERA INFERIOR-RAD. A TUBO	21891
MANGUERA SUPERIOR-TUBO A RAD.	21135	MANGUERA SUPERIOR-RAD. A TUBO	21135
MANGUERA SILICÓN-MOTOR A TUBO	SIH250363C	MANGUERA SUPERIOR-MOTOR A TUBO	CHARTER 2 1/2"
BANDA-ALT-VENT	K080859	MANGUERA INFERIOR-	CHARTER 2 1/2"
POLEA-ALT-VENT	36091	9100	
TENSOR-ALT-VENT	38506	DETROIT DIESEL SERIE 60	
TERMOSTATO-190°	33579	1999	
TERMOSTATO-180°	33576	BANDA-VENT	K100570
TERMOSTATO-180°	33578	POLEA DEL TENSOR-VENT	36092
TERMOSTATO-170°	33577	TENSOR-VENT	38529
2003		MANGUERA SILICÓN-TUBO A RAD.	SIH250363C
BANDA-VENT-AA	K060586	MANGUERA SUPERIOR-TUBO A RAD.	21135
POLEA DEL TENSOR-VENT-AA	36091	MANGUERA SILICÓN-MOTOR A TUBO	SIH250363C
TENSOR-VENT-AA	38507	MANGUERA SUPERIOR-MOTOR A TUBO	21891
MANGUERA INFERIOR-TUBO A RAD.	21891	BANDA-ALT	K060455
MANGUERA SUPERIOR-TUBO A RAD.	21135	BANDA-AA	K060490
MANGUERA SILICÓN-MOTOR A TUBO	SIH250363C	TERMOSTATO-190°	33599
MANGUERA SUPERIOR-MOTOR A TUBO	21135	1998	
BANDA-ALT-VENT	K080859	BANDA-VENT	K100570
POLEA-ALT-VENT	36091	POLEA DEL TENSOR-VENT	36092
TENSOR-ALT-VENT	38506	TENSOR-VENT	38519
TERMOSTATO-190°	33579	MANGUERA SILICÓN-TUBO A RAD.	SIH250363C
TERMOSTATO-180°	33576	MANGUERA SILICÓN-MOTOR A TUBO	SIH250363C
TERMOSTATO-180°	33578	BANDA-ALT	2/9313PB
TERMOSTATO-170°	33577	BANDA-ALT	9313
2002		BANDA-ALT	K060455
TERMOSTATO-190°	33579	BANDA-AA	K060490
TERMOSTATO-180°	33576	TERMOSTATO-190°	33599
TERMOSTATO-180°	33578	CUMMINS N14 DIESEL	



1999		BANDA-ALT-VENT	K080733
BANDA-VENT	K100465	TERMOSTATO-190°	33579
MANGUERA INFERIOR-TUBO A RAD.	21135	TERMOSTATO-180°	33576
MANGUERA SUPERIOR-TUBO A RAD.	21135	TERMOSTATO-180°	33578
BANDA-TOMA DE FUERZA-AA	9405	TERMOSTATO-170°	33577
MANGUERA SILICÓN-MOTOR A TUBO	SIH250363C		
BANDA-BA	K060415	1998	
BANDA-ALT	2/9447PB	BANDA-VENT-AA	2/9463PB
BANDA-ALT	9447	BANDA-VENT-AA	9463
TERMOSTATO-190°	33579	MANGUERA SILICÓN-TUBO A RAD.	SIH250363C
TERMOSTATO-180°	33576	MANGUERA INFERIOR-RAD. A TUBO	21135
TERMOSTATO-180°	33578	MANGUERA INFERIOR-MOTOR A TUBO	21891
TERMOSTATO-170°	33577	MANGUERA SUPERIOR-MOTOR A TUBO	21135
		BANDA-ALT-VENT	K080733
1998		TERMOSTATO-190°	33579
BANDA-VENT	K100510	TERMOSTATO-180°	33576
MANGUERA SILICÓN-TUBO A RAD.	SIH250363C	TERMOSTATO-180°	33578
MANGUERA SILICÓN-MOTOR A TUBO	SIH250363C	TERMOSTATO-170°	33577
BANDA-BA	K060415		
BANDA-ALT	2/9447PB	CATERPILLAR C10 DIESEL	
BANDA-ALT	9447	1999	
TERMOSTATO-190°	33579	BANDA-VENT-AA	2/9463PB
TERMOSTATO-180°	33576	BANDA-VENT-AA	9463
TERMOSTATO-180°	33578	MANGUERA SILICÓN-TUBO A RAD.	SIH250363C
TERMOSTATO-170°	33577	MANGUERA INFERIOR-RAD. A TUBO	21135
BANDA-	9405	MANGUERA INFERIOR-MOTOR A TUBO	21891
		MANGUERA SUPERIOR-MOTOR A TUBO	21135
CUMMINS M11 DIESEL		BANDA-ALT-VENT	K080733
1998		TERMOSTATO-190°	33579
TERMOSTATO-190°	33579	TERMOSTATO-180°	33576
TERMOSTATO-180°	33576	TERMOSTATO-180°	33578
TERMOSTATO-180°	33578	TERMOSTATO-170°	33577
TERMOSTATO-170°	33577		
CUMMINS ISM DIESEL		1998	
1999		BANDA-VENT-AA	2/9463PB
BANDA-VENT	K080465	BANDA-VENT-AA	9463
BANDA-ALT	K050336	MANGUERA SUPERIOR-TUBO A RAD.	21135
		MANGUERA INFERIOR-RAD. A TUBO	21135
CATERPILLAR C12 DIESEL		MANGUERA INFERIOR-MOTOR A TUBO	21891
1999		MANGUERA SILICÓN-MOTOR A TUBO	SIH250363C
BANDA-VENT-AA	2/9463PB	BANDA-ALT-VENT	K080733
BANDA-VENT-AA	9463	TERMOSTATO-190°	33579
MANGUERA SILICÓN-TUBO A RAD.	SIH250363C	TERMOSTATO-180°	33576
MANGUERA INFERIOR-RAD. A TUBO	21135	TERMOSTATO-180°	33578
MANGUERA INFERIOR-MOTOR A TUBO	21891	TERMOSTATO-170°	33577
MANGUERA SUPERIOR-MOTOR A TUBO	21135		
		CATERPILLAR 3406 DIESEL	



1998	
BANDA-VENT-AA	K060500
MANGUERA SILICÓN-TUBO A RAD.	SIH250363C
MANGUERA SILICÓN-MOTOR A TUBO	SIH250363C
MANGUERA SILICÓN-MOTOR A TUBO	SIH300363C
BANDA-ALT-VENT	K100771
TERMOSTATO-190°	33579
TERMOSTATO-180°	33576
TERMOSTATO-180°	33578
TERMOSTATO-170°	33577

9100I

DETROIT DIESEL SERIE 60

2000

BANDA-VENT	K100570
POLEA DEL TENSOR-VENT	36092
TENSOR-VENT	38529
MANGUERA SILICÓN-TUBO A RAD.	SIH250363C
MANGUERA SUPERIOR-TUBO A RAD.	21135
BANDA-TOMA DE FUERZA-AA	K060340
MANGUERA SILICÓN-MOTOR A TUBO	SIH250363C
MANGUERA SUPERIOR-MOTOR A TUBO	21891
BANDA-ALT-VENT	K060455
TERMOSTATO-190°	33599

DETROIT DIESEL 6 CIL, 12.7 L DIESEL

2003

BANDA-VENT	K100570
POLEA DEL TENSOR-VENT	36092
TENSOR-VENT	38529
BANDA-AA	K060340

2002

BANDA-VENT	K100540
MANGUERA INFERIOR-RAD. A TUBO	21135
MANGUERA SUPERIOR-RAD. A TUBO	21135
MANGUERA SILICÓN-MOTOR A TUBO	SIH250363C

2001

BANDA-VENT	K100570
POLEA DEL TENSOR-VENT	36092
TENSOR-VENT	38529
MANGUERA INFERIOR-TUBO A RAD.	21135
MANGUERA SUPERIOR-TUBO A RAD.	21135
BANDA-TOMA DE FUERZA-AA	K060340
MANGUERA SILICÓN-MOTOR A TUBO	SIH250363C
MANGUERA SUPERIOR-MOTOR A TUBO	21891

BANDA-ALT-VENT	K060455
----------------	---------

CUMMINS N14 DIESEL

2003

BANDA-VENT	K100465
MANGUERA INFERIOR-TUBO A RAD.	21135
MANGUERA SUPERIOR-TUBO A RAD.	21135
BANDA-TOMA DE FUERZA-AA	9405
MANGUERA SILICÓN-MOTOR A TUBO	SIH250363C
BANDA-BA	K060415
BANDA-ALT	2/9447PB
BANDA-ALT	9447
TERMOSTATO-190°	33579
TERMOSTATO-180°	33576
TERMOSTATO-180°	33578
TERMOSTATO-170°	33577

2002

BANDA-VENT	K100465
MANGUERA INFERIOR-TUBO A RAD.	21135
MANGUERA SUPERIOR-TUBO A RAD.	21135
BANDA-TOMA DE FUERZA-AA	9405
MANGUERA SILICÓN-MOTOR A TUBO	SIH250363C
BANDA-BA	K060415
BANDA-ALT	2/9447PB
BANDA-ALT	9447
TERMOSTATO-190°	33579
TERMOSTATO-180°	33576
TERMOSTATO-180°	33578
TERMOSTATO-170°	33577

2001

BANDA-VENT	K100465
MANGUERA INFERIOR-TUBO A RAD.	21135
MANGUERA SUPERIOR-TUBO A RAD.	21135
BANDA-TOMA DE FUERZA-AA	9405
MANGUERA SILICÓN-MOTOR A TUBO	SIH250363C
BANDA-BA	K060415
BANDA-ALT	2/9447PB
BANDA-ALT	9447
TERMOSTATO-190°	33579
TERMOSTATO-180°	33576
TERMOSTATO-180°	33578
TERMOSTATO-170°	33577

2000

BANDA-VENT	K100465
------------	---------



MANGUERA INFERIOR-TUBO A RAD.	21135	MANGUERA INFERIOR-MOTOR A TUBO	21891
MANGUERA SUPERIOR-TUBO A RAD.	21135	MANGUERA SUPERIOR-MOTOR A TUBO	CHARTER 2 1/2"
BANDA-TOMA DE FUERZA-AA	9405	CUMMINS ISM DIESEL	
MANGUERA SILICÓN-MOTOR A TUBO	SIH250363C	2003	
BANDA-BA	K060415	BANDA-VENT	K080565
BANDA-ALT	2/9447PB	MANGUERA INFERIOR-TUBO A RAD.	CHARTER 2 1/2"
BANDA-ALT	9447	MANGUERA SUPERIOR-TUBO A RAD.	21135
TERMOSTATO-190°	33579	BANDA-TOMA DE FUERZA-ALT	K050336
TERMOSTATO-180°	33576	BANDA-TOMA DE FUERZA-AA	TR22485
TERMOSTATO-180°	33578	MANGUERA INFERIOR-MOTOR A TUBO	21135
TERMOSTATO-170°	33577	MANGUERA SUPERIOR-MOTOR A TUBO	CHARTER 2 1/2"
CUMMINS ISX DIESEL		2002	
2003		BANDA-VENT	K080565
BANDA-VENT	K100719	MANGUERA INFERIOR-TUBO A RAD.	CHARTER 2 1/2"
POLEA DEL TENSOR-VENT	36092	MANGUERA SUPERIOR-TUBO A RAD.	21135
TENSOR-VENT	38535	BANDA-TOMA DE FUERZA-ALT	K050336
MANGUERA INFERIOR-TUBO A RAD.	21135	BANDA-TOMA DE FUERZA-AA	TR22485
MANGUERA SUPERIOR-TUBO A RAD.	21135	MANGUERA INFERIOR-MOTOR A TUBO	21135
BANDA-TOMA DE FUERZA-ALT-AA	K060685	MANGUERA SUPERIOR-MOTOR A TUBO	CHARTER 2 1/2"
POLEA DEL TENSOR-TOMA DE FUERZA-ALT-AA	36095	2001	
TENSOR-TOMA DE FUERZA-ALT-AA	38532	BANDA-VENT	K080565
MANGUERA INFERIOR-MOTOR A TUBO	21891	MANGUERA INFERIOR-TUBO A RAD.	CHARTER 2 1/2"
MANGUERA SUPERIOR-MOTOR A TUBO	CHARTER 2 1/2"	MANGUERA SUPERIOR-TUBO A RAD.	21135
2002		BANDA-TOMA DE FUERZA-ALT	K050336
BANDA-VENT	K100719	BANDA-TOMA DE FUERZA-AA	TR22485
POLEA DEL TENSOR-VENT	36092	MANGUERA INFERIOR-MOTOR A TUBO	21135
TENSOR-VENT	38535	MANGUERA SUPERIOR-MOTOR A TUBO	CHARTER 2 1/2"
MANGUERA INFERIOR-TUBO A RAD.	21135	2000	
MANGUERA SUPERIOR-TUBO A RAD.	21135	BANDA-VENT	K080565
BANDA-TOMA DE FUERZA-ALT-AA	K060685	MANGUERA SILICÓN-TUBO A RAD.	SIH250363C
POLEA DEL TENSOR-TOMA DE FUERZA-ALT-AA	36095	MANGUERA SUPERIOR-TUBO A RAD.	21135
TENSOR-TOMA DE FUERZA-ALT-AA	38532	BANDA-TOMA DE FUERZA-ALT	K050336
MANGUERA INFERIOR-MOTOR A TUBO	21891	BANDA-TOMA DE FUERZA-AA	TR22485
MANGUERA SUPERIOR-MOTOR A TUBO	CHARTER 2 1/2"	MANGUERA INFERIOR-MOTOR A TUBO	21135
2001		MANGUERA SILICÓN-MOTOR A TUBO	SIH250363C
BANDA-VENT	K100719	CATERPILLAR C12 DIESEL	
POLEA DEL TENSOR-VENT	36092	2003	
TENSOR-VENT	38535	BANDA-VENT-AA	2/9463PB
MANGUERA INFERIOR-TUBO A RAD.	21135	BANDA-VENT-AA	9463
MANGUERA SUPERIOR-TUBO A RAD.	21135	MANGUERA SILICÓN-TUBO A RAD.	SIH250363C
BANDA-TOMA DE FUERZA-ALT-AA	K060685	MANGUERA INFERIOR-RAD. A TUBO	21135
POLEA DEL TENSOR-TOMA DE FUERZA-ALT-AA	36095	MANGUERA INFERIOR-MOTOR A TUBO	21891
TENSOR-TOMA DE FUERZA-ALT-AA	38532	MANGUERA SUPERIOR-MOTOR A TUBO	21135



MASTER SERVICIO PESADO 2014

INTERNATIONAL/
NAVISTAR
91001

BANDA-ALT-VENT	K080733	BANDA-VENT-AA	2/9463PB
TERMOSTATO-190°	33579	BANDA-VENT-AA	9463
TERMOSTATO-180°	33576	MANGUERA SILICÓN-TUBO A RAD.	SIH250363C
TERMOSTATO-180°	33578	MANGUERA INFERIOR-RAD. A TUBO	21135
TERMOSTATO-170°	33577	MANGUERA INFERIOR-MOTOR A TUBO	21891
2002		MANGUERA SUPERIOR-MOTOR A TUBO	21135
BANDA-VENT-AA	2/9463PB	BANDA-ALT-VENT	K080733
BANDA-VENT-AA	9463	TERMOSTATO-190°	33579
MANGUERA SILICÓN-TUBO A RAD.	SIH250363C	TERMOSTATO-180°	33576
MANGUERA INFERIOR-RAD. A TUBO	21135	TERMOSTATO-180°	33578
MANGUERA INFERIOR-MOTOR A TUBO	21891	TERMOSTATO-170°	33577
MANGUERA SUPERIOR-MOTOR A TUBO	21135	2002	
BANDA-ALT-VENT	K080733	BANDA-VENT-AA	2/9463PB
TERMOSTATO-190°	33579	BANDA-VENT-AA	9463
TERMOSTATO-180°	33576	MANGUERA SILICÓN-TUBO A RAD.	SIH250363C
TERMOSTATO-180°	33578	MANGUERA INFERIOR-RAD. A TUBO	21135
TERMOSTATO-170°	33577	MANGUERA INFERIOR-MOTOR A TUBO	21891
2001		MANGUERA SUPERIOR-MOTOR A TUBO	21135
BANDA-VENT-AA	2/9463PB	BANDA-ALT-VENT	K080733
BANDA-VENT-AA	9463	TERMOSTATO-190°	33579
MANGUERA SILICÓN-TUBO A RAD.	SIH250363C	TERMOSTATO-180°	33576
MANGUERA INFERIOR-RAD. A TUBO	21135	TERMOSTATO-180°	33578
MANGUERA INFERIOR-MOTOR A TUBO	21891	TERMOSTATO-170°	33577
MANGUERA SUPERIOR-MOTOR A TUBO	21135	2001	
BANDA-ALT-VENT	K080733	BANDA-VENT-AA	2/9463PB
TERMOSTATO-190°	33579	BANDA-VENT-AA	9463
TERMOSTATO-180°	33576	MANGUERA SILICÓN-TUBO A RAD.	SIH250363C
TERMOSTATO-180°	33578	MANGUERA INFERIOR-RAD. A TUBO	21135
TERMOSTATO-170°	33577	MANGUERA INFERIOR-MOTOR A TUBO	21891
2000		MANGUERA SUPERIOR-MOTOR A TUBO	21135
BANDA-VENT-AA	2/9463PB	BANDA-ALT-VENT	K080733
BANDA-VENT-AA	9463	TERMOSTATO-190°	33579
MANGUERA SILICÓN-TUBO A RAD.	SIH250363C	TERMOSTATO-180°	33576
MANGUERA INFERIOR-RAD. A TUBO	21135	TERMOSTATO-180°	33578
MANGUERA INFERIOR-MOTOR A TUBO	21891	TERMOSTATO-170°	33577
MANGUERA SUPERIOR-MOTOR A TUBO	21135	2000	
BANDA-ALT-VENT	K080733	BANDA-VENT-AA	2/9463PB
TERMOSTATO-190°	33579	BANDA-VENT-AA	9463
TERMOSTATO-180°	33576	MANGUERA SILICÓN-TUBO A RAD.	SIH250363C
TERMOSTATO-180°	33578	MANGUERA INFERIOR-RAD. A TUBO	21135
TERMOSTATO-170°	33577	MANGUERA INFERIOR-MOTOR A TUBO	21891
CATERPILLAR C10 DIESEL		MANGUERA SUPERIOR-MOTOR A TUBO	21135
2003		BANDA-ALT-VENT	K080733



TERMOSTATO-190°	33579	1995	
TERMOSTATO-180°	33576	BANDA-VENT	K100637
TERMOSTATO-180°	33578	POLEA DEL TENSOR-VENT	36092
TERMOSTATO-170°	33577	TENSOR-VENT	38519

9200

DETROIT DIESEL SERIE 60

1999

BANDA-VENT	K100570
POLEA DEL TENSOR-VENT	36092
TENSOR-VENT	38529
MANGUERA SILICÓN-TUBO A RAD.	SIH250363C
MANGUERA SUPERIOR-TUBO A RAD.	21135
MANGUERA SILICÓN-MOTOR A TUBO	SIH250363C
MANGUERA SUPERIOR-MOTOR A TUBO	21891
BANDA-ALT	K060455
BANDA-AA	K060490
TERMOSTATO-190°	33599

1998

BANDA-VENT	K100570
POLEA DEL TENSOR-VENT	36092
TENSOR-VENT	38519
MANGUERA SILICÓN-TUBO A RAD.	SIH250363C
MANGUERA SILICÓN-MOTOR A TUBO	SIH250363C
BANDA-ALT	2/9313PB
BANDA-ALT	9313
BANDA-ALT	K060455
BANDA-AA	K060490
TERMOSTATO-190°	33599

DETROIT DIESEL 6 CIL, 12.7 L DIESEL

1997

BANDA-VENT	K100637
POLEA DEL TENSOR-VENT	36092
TENSOR-VENT	38519
BANDA-ALT	9313
BANDA-AA	K060490
TERMOSTATO-190°	33599

1996

BANDA-VENT	K100637
POLEA DEL TENSOR-VENT	36092
TENSOR-VENT	38519
BANDA-ALT	9313
BANDA-AA	K060490
TERMOSTATO-190°	33599

DETROIT DIESEL 6 CIL, 11.1 L DIESEL

1997

BANDA-VENT	K100637
POLEA DEL TENSOR-VENT	36092
TENSOR-VENT	38519
BANDA-ALT	9313
BANDA-AA	K060490
TERMOSTATO-190°	33599
BANDA-VENT	K100637
POLEA DEL TENSOR-VENT	36092
TENSOR-VENT	38519
BANDA-ALT	9313
BANDA-AA	K060490
TERMOSTATO-190°	33599

1995

BANDA-VENT	K100637
POLEA DEL TENSOR-VENT	36092
TENSOR-VENT	38519
BANDA-ALT	9313
BANDA-AA	K060490
TERMOSTATO-190°	33599

CUMMINS N14 DIESEL

1999

BANDA-VENT	K100465
MANGUERA INFERIOR-TUBO A RAD.	21135
MANGUERA SUPERIOR-TUBO A RAD.	21135
BANDA-TOMA DE FUERZA-AA	9405
MANGUERA SILICÓN-MOTOR A TUBO	SIH250363C
BANDA-BA	K060415
BANDA-ALT	2/9447PB
BANDA-ALT	9447
TERMOSTATO-190°	33579
TERMOSTATO-180°	33576
TERMOSTATO-180°	33578
TERMOSTATO-170°	33577



MASTER SERVICIO PESADO 2014

INTERNATIONAL/
NAVISTAR
9200

1998			BANDA-ALT	2/9447PB
BANDA-VENT	K100510		BANDA-ALT	2/9463PB
MANGUERA SILICÓN-TUBO A RAD.	SIH250363C		BANDA-ALT	9440
MANGUERA SILICÓN-MOTOR A TUBO	SIH250363C		BANDA-ALT	9447
BANDA-BA	K060415		BANDA-ALT	9463
BANDA-ALT	2/9447PB		TERMOSTATO-190°	33579
BANDA-ALT	9447		TERMOSTATO-180°	33576
TERMOSTATO-190°	33579		TERMOSTATO-180°	33578
TERMOSTATO-180°	33576		TERMOSTATO-170°	33577
TERMOSTATO-180°	33578		BANDA-	9405
TERMOSTATO-170°	33577		BANDA-	9412
BANDA-	9405		1995	
1997			TERMOSTATO-190°	33579
BANDA-VENT	K100456		TERMOSTATO-180°	33576
BANDA-VENT	K100510		TERMOSTATO-180°	33578
MANGUERA SILICÓN-TUBO A RAD.	SIH250363C		TERMOSTATO-170°	33577
MANGUERA SILICÓN-MOTOR A TUBO	SIH250363C		CUMMINS M11 DIESEL	
BANDA-BA	K060415		1998	
BANDA-ALT	2/9447PB		BANDA-VENT	K080605
BANDA-ALT	2/9463PB		MANGUERA SILICÓN-TUBO A RAD.	SIH250363C
BANDA-ALT	9447		MANGUERA SILICÓN-MOTOR A TUBO	SIH250363C
BANDA-ALT	9463		BANDA-ALT	K050336
TERMOSTATO-190°	33579		TERMOSTATO-190°	33579
TERMOSTATO-180°	33576		TERMOSTATO-180°	33576
TERMOSTATO-180°	33578		TERMOSTATO-180°	33578
TERMOSTATO-170°	33577		TERMOSTATO-170°	33577
1996			BANDA-	TR22485
BANDA-VENT-C/VENT ROCKFORD	TR28522		1997	
BANDA-VENT-C/VENT CLUTCH BENDIX, FACET, KYSOR, WESTINHOUSE	TR28510		BANDA-VENT	K080605
BANDA-VENT- OPCIONAL	TR28473		MANGUERA SILICÓN-TUBO A RAD.	SIH250363C
BANDA-VENT- OPCIONAL	TR28480		MANGUERA SILICÓN-MOTOR A TUBO	SIH250363C
BANDA-VENT- OPCIONAL	TR28492		BANDA-ALT	K050336
BANDA-VENT	2/TR28473PB		TERMOSTATO-190°	33579
BANDA-VENT	2/TR28480PB		TERMOSTATO-180°	33576
BANDA-VENT	2/TR28492PB		TERMOSTATO-180°	33578
BANDA-VENT	TR28550		TERMOSTATO-170°	33577
BANDA-VENT	TR28565		BANDA-	TR22485
MANGUERA SILICÓN-TUBO A RAD.	SIH250363C		1996	
MANGUERA SILICÓN-MOTOR A TUBO	SIH250363C		BANDA-VENT	K080605
BANDA-C/DOBLE COMP	9330		MANGUERA SILICÓN-TUBO A RAD.	SIH250363C
BANDA-C/COMP TECUMSEH	2/9430PB		MANGUERA SILICÓN-MOTOR A TUBO	SIH250363C
BANDA-C/COMP TECUMSEH	9430		BANDA-ALT	K050336
BANDA-BA	K040430		TERMOSTATO-190°	33579

SOLUCIONES CONFIABLES

¡Pídelos!



Limpiaparabrisas para Servicio Pesado

MegaVision® HD

- Nuevos Limpiaparabrisas para Camionetas y Autobuses
- Estructura de metal reforzada con remaches de acero inoxidable
- Para todo tipo de clima



ACM		
HL	40" / 1000 mm	Perno
HL L	40" / 1000 mm	Perno
HL II	40" / 1000 mm	Perno
HL III	40" / 1000 mm	Perno
BUSSCAR		
Busscar Bus 360	40" / 1000 mm	Perno
DINA		
F12	40" / 1000 mm	Perno
IRIZAR		
Century	40" / 1000 mm	Perno
PB	40" / 1000 mm	Perno
MAN		
Lion's Coach	40" / 1000 mm	Perno
Mercedes Benz		
Gran Viale		
MetroBus	38" / 954mm	Perno
Andare	40" / 1000 mm	Perno
Multego	40" / 1000 mm	Perno
Turiclass	40" / 1000 mm	Perno
SCANIA		
MetroBus	38" / 954mm	Perno
VOLVO		
7300 MetroBus	38" / 954mm	Perno
7550	38" / 954mm	Perno
7700 MetroBus	38" / 954mm	Gancho
9300	38" / 954mm	Gancho
9700 (ant. 2008)	40" / 1000 mm	Gancho
9700 (post. 2008)	40" / 1000 mm	Perno

TABLA DE APLICACIONES

- Medidas disponibles de 38" y 40"



MASTER SERVICIO PESADO 2014

INTERNATIONAL/
NAVISTAR
9200

TERMOSTATO-180°	33576	BANDA-ALT-VENT	K080733
TERMOSTATO-180°	33578	TERMOSTATO-190°	33579
TERMOSTATO-170°	33577	TERMOSTATO-180°	33576
BANDA-	TR22485	TERMOSTATO-180°	33578
1995		TERMOSTATO-170°	33577
BANDA-VENT	K080605	1998	
MANGUERA SILICÓN-TUBO A RAD.	SIH250363C	BANDA-VENT-AA	2/9463PB
MANGUERA SILICÓN-MOTOR A TUBO	SIH250363C	BANDA-VENT-AA	9463
BANDA-ALT	K050336	MANGUERA SILICÓN-TUBO A RAD.	SIH250363C
TERMOSTATO-190°	33579	MANGUERA INFERIOR-RAD. A TUBO	21135
TERMOSTATO-180°	33576	MANGUERA INFERIOR-MOTOR A TUBO	21891
TERMOSTATO-180°	33578	MANGUERA SUPERIOR-MOTOR A TUBO	21135
TERMOSTATO-170°	33577	BANDA-ALT-VENT	K080733
BANDA-	TR22485	TERMOSTATO-190°	33579
CUMMINS ISX DIESEL		TERMOSTATO-180°	33576
2005		TERMOSTATO-180°	33578
BANDA-TOMA DE FUERZA-AA	K060637	TERMOSTATO-170°	33577
MANGUERA INFERIOR-RAD. A TUBO	21891	1997	
MANGUERA SUPERIOR-RAD. A TUBO	21135	BANDA-VENT-AA	2/9463PB
MANGUERA SUPERIOR-MOTOR A TUBO	21135	BANDA-VENT-AA	9463
BANDA-ALT-VENT	K120911	MANGUERA SILICÓN-TUBO A RAD.	SIH250363C
MANGUERA INFERIOR-	CHARTER 2 1/2"	MANGUERA INFERIOR-RAD. A TUBO	21135
CUMMINS ISM DIESEL		MANGUERA INFERIOR-MOTOR A TUBO	21891
2005		MANGUERA SUPERIOR-MOTOR A TUBO	21135
BANDA-TOMA DE FUERZA-AA	K060516	BANDA-ALT-VENT	K080733
TENSOR-TOMA DE FUERZA-AA	38505	TERMOSTATO-190°	33579
MANGUERA INFERIOR-RAD. A TUBO	21891	TERMOSTATO-180°	33576
MANGUERA SUPERIOR-RAD. A TUBO	21135	TERMOSTATO-180°	33578
MANGUERA SUPERIOR-MOTOR A TUBO	CHARTER 2 1/2"	TERMOSTATO-170°	33577
BANDA-ALT-VENT	K080740	1996	
TENSOR-ALT-VENT	38521	BANDA-VENT-AA	2/9463PB
MANGUERA INFERIOR-	CHARTER 2 1/2"	BANDA-VENT-AA	9463
1999		MANGUERA SILICÓN-TUBO A RAD.	SIH250363C
BANDA-VENT	K080465	MANGUERA INFERIOR-RAD. A TUBO	21135
BANDA-ALT	K050336	MANGUERA INFERIOR-MOTOR A TUBO	21891
CATERPILLAR C12 DIESEL		MANGUERA SUPERIOR-MOTOR A TUBO	21135
1999		BANDA-ALT-VENT	K080720
BANDA-VENT-AA	2/9463PB	TERMOSTATO-190°	33579
BANDA-VENT-AA	9463	TERMOSTATO-180°	33576
MANGUERA SILICÓN-TUBO A RAD.	SIH250363C	TERMOSTATO-180°	33578
MANGUERA INFERIOR-RAD. A TUBO	21135	TERMOSTATO-170°	33577
MANGUERA INFERIOR-MOTOR A TUBO	21891	CATERPILLAR C10 DIESEL	
MANGUERA SUPERIOR-MOTOR A TUBO	21135	1999	



MASTER SERVICIO PESADO 2014

INTERNATIONAL/
NAVISTAR
9200

BANDA-VENT-AA	2/9463PB	TERMOSTATO-190°	33579
BANDA-VENT-AA	9463	TERMOSTATO-180°	33576
MANGUERA SILICÓN-TUBO A RAD.	SIH250363C	TERMOSTATO-180°	33578
MANGUERA INFERIOR-RAD. A TUBO	21135	TERMOSTATO-175°	33960
MANGUERA INFERIOR-MOTOR A TUBO	21891	TERMOSTATO-170°	33577
MANGUERA SUPERIOR-MOTOR A TUBO	21135	CATERPILLAR 3406 DIESEL	
BANDA-ALT-VENT	K080733	1998	
TERMOSTATO-190°	33579	BANDA-VENT-AA	K060500
TERMOSTATO-180°	33576	MANGUERA SILICÓN-TUBO A RAD.	SIH250363C
TERMOSTATO-180°	33578	MANGUERA SILICÓN-MOTOR A TUBO	SIH250363C
TERMOSTATO-170°	33577	MANGUERA SILICÓN-MOTOR A TUBO	SIH300363C
1998		BANDA-ALT-VENT	K100771
BANDA-VENT-AA	2/9463PB	TERMOSTATO-190°	33579
BANDA-VENT-AA	9463	TERMOSTATO-180°	33576
MANGUERA SILICÓN-TUBO A RAD.	SIH250363C	TERMOSTATO-180°	33578
MANGUERA INFERIOR-RAD. A TUBO	21135	TERMOSTATO-170°	33577
MANGUERA INFERIOR-MOTOR A TUBO	21891	1997	
MANGUERA SUPERIOR-MOTOR A TUBO	21135	BANDA-VENT-AA	K060500
BANDA-ALT-VENT	K080733	MANGUERA SILICÓN-TUBO A RAD.	SIH250363C
TERMOSTATO-190°	33579	MANGUERA SILICÓN-MOTOR A TUBO	SIH250363C
TERMOSTATO-180°	33576	MANGUERA SILICÓN-MOTOR A TUBO	SIH300363C
TERMOSTATO-180°	33578	BANDA-ALT-VENT	K100771
TERMOSTATO-170°	33577	TERMOSTATO-190°	33579
1997		TERMOSTATO-180°	33576
BANDA-VENT-AA	2/9463PB	TERMOSTATO-180°	33578
BANDA-VENT-AA	9463	TERMOSTATO-170°	33577
MANGUERA SILICÓN-TUBO A RAD.	SIH250363C	1996	
MANGUERA INFERIOR-RAD. A TUBO	21135	MANGUERA SILICÓN-TUBO A RAD.	SIH250363C
MANGUERA INFERIOR-MOTOR A TUBO	21891	MANGUERA SILICÓN-MOTOR A TUBO	SIH250363C
MANGUERA SUPERIOR-MOTOR A TUBO	21135	MANGUERA SILICÓN-MOTOR A TUBO	SIH300363C
BANDA-ALT-VENT	K080733	BANDA-ALT-VENT	K100771
TERMOSTATO-190°	33579	BANDA-AA	K060500
TERMOSTATO-180°	33576	TERMOSTATO-190°	33579
TERMOSTATO-180°	33578	TERMOSTATO-180°	33576
TERMOSTATO-170°	33577	TERMOSTATO-180°	33578
1996		TERMOSTATO-170°	33577
BANDA-VENT-AA	2/9463PB	1995	
BANDA-VENT-AA	9463	TERMOSTATO-190°	33579
MANGUERA SILICÓN-TUBO A RAD.	SIH250363C	TERMOSTATO-180°	33576
MANGUERA INFERIOR-RAD. A TUBO	21135	TERMOSTATO-180°	33578
MANGUERA INFERIOR-MOTOR A TUBO	21891	TERMOSTATO-170°	33577
MANGUERA SUPERIOR-MOTOR A TUBO	21135	CATERPILLAR 3176 DIESEL	
BANDA-ALT-VENT	K080720	1997	



MASTER SERVICIO PESADO 2014

INTERNATIONAL/
NAVISTAR
9200

TERMOSTATO-190°	33579	TERMOSTATO-190°	33599
TERMOSTATO-180°	33576	2002	
TERMOSTATO-180°	33578	BANDA-VENT	K100540
TERMOSTATO-170°	33577	MANGUERA INFERIOR-RAD. A TUBO	21135
1996		MANGUERA SUPERIOR-RAD. A TUBO	21135
TERMOSTATO-190°	33579	MANGUERA SILICÓN-MOTOR A TUBO	SIH250363C
TERMOSTATO-180°	33576	TERMOSTATO-190°	33599
TERMOSTATO-180°	33578	2001	
TERMOSTATO-170°	33577	BANDA-VENT	K100570
1995		POLEA DEL TENSOR-VENT	36092
MANGUERA INFERIOR-RAD. A TUBO	24436	TENSOR-VENT	38529
MANGUERA SILICÓN-RAD. A TUBO	SIH200363C	MANGUERA INFERIOR-TUBO A RAD.	21135
MANGUERA SILICÓN-MOTOR A TUBO	SIH200363C	MANGUERA SUPERIOR-TUBO A RAD.	21135
MANGUERA SILICÓN-MOTOR A TUBO	SIH250363C	BANDA-TOMA DE FUERZA-AA	K060340
BANDA-ALT-VENT-C/VENT CLUTCH KYSOR	K080720	MANGUERA SILICÓN-MOTOR A TUBO	SIH250363C
BANDA-ALT-VENT-C/VENT CLUTCH HORTON, KYSOR, SCHWITZER, C/ALT LEECE NEVILLE	K080733	MANGUERA SUPERIOR-MOTOR A TUBO	21891
BANDA-ALT-VENT-C/ALT DELCO, C/VENT CLUTCH HORTON/KYSOR/SCHWITZER	K080738	BANDA-ALT-VENT	K060455
POLEA-ALT-VENT	36091	CUMMINS SIGNATURE 600 DIESEL	
TENSOR-ALT-VENT	38506	2002	
TERMOSTATO-190°	33579	BANDA-VENT	K100719
TERMOSTATO-180°	33576	POLEA DEL TENSOR-VENT	36092
TERMOSTATO-180°	33578	TENSOR-VENT	38535
TERMOSTATO-170°	33577	BANDA-TOMA DE FUERZA-ALT-AA	K060680
BANDA-	9525	POLEA DEL TENSOR-TOMA DE FUERZA-ALT-AA	36095
		TENSOR-TOMA DE FUERZA-ALT-AA	38532
9200I		2001	
DETROIT DIESEL SERIE 60		BANDA-VENT	K100719
2000		POLEA DEL TENSOR-VENT	36092
BANDA-VENT	K100570	TENSOR-VENT	38535
POLEA DEL TENSOR-VENT	36092	BANDA-TOMA DE FUERZA-ALT-AA	K060680
TENSOR-VENT	38529	POLEA DEL TENSOR-TOMA DE FUERZA-ALT-AA	36095
MANGUERA SILICÓN-TUBO A RAD.	SIH250363C	TENSOR-TOMA DE FUERZA-ALT-AA	38532
MANGUERA SUPERIOR-TUBO A RAD.	21135	2000	
BANDA-TOMA DE FUERZA-AA	K060340	BANDA-VENT	K100719
MANGUERA SILICÓN-MOTOR A TUBO	SIH250363C	POLEA DEL TENSOR-VENT	36092
MANGUERA SUPERIOR-MOTOR A TUBO	21891	TENSOR-VENT	38535
BANDA-ALT-VENT	K060455	BANDA-TOMA DE FUERZA-ALT-AA	K060680
TERMOSTATO-190°	33599	POLEA DEL TENSOR-TOMA DE FUERZA-ALT-AA	36095
DETROIT DIESEL 6 CIL, 12.7 L DIESEL		TENSOR-TOMA DE FUERZA-ALT-AA	38532
2003		CUMMINS N14 DIESEL	
BANDA-VENT	K100540	2003	
MANGUERA INFERIOR-RAD. A TUBO	21135	MANGUERA INFERIOR-TUBO A RAD.	21135
MANGUERA SUPERIOR-RAD. A TUBO	21135	MANGUERA SUPERIOR-TUBO A RAD.	21135
MANGUERA SILICÓN-MOTOR A TUBO	SIH250363C		



MASTER SERVICIO PESADO 2014

INTERNATIONAL/
NAVISTAR
92001

BANDA-TOMA DE FUERZA-VENT	K100465	BANDA-ALT	2/9447PB
BANDA-TOMA DE FUERZA-BA	K060425	BANDA-ALT	9447
BANDA-TOMA DE FUERZA-AA	9405	TERMOSTATO-190°	33579
MANGUERA INFERIOR-MOTOR A TUBO	CHARTER 2 1/2"	TERMOSTATO-180°	33576
MANGUERA SILICÓN-MOTOR A TUBO	SIH250363C	TERMOSTATO-180°	33578
BANDA-ALT	9447	TERMOSTATO-170°	33577
TERMOSTATO-190°	33579	CUMMINS ISX DIESEL	
TERMOSTATO-180°	33576	2013	
TERMOSTATO-180°	33578	BANDA-TOMA DE FUERZA-AA	K060637
TERMOSTATO-170°	33577	TENSOR-TOMA DE FUERZA-AA	38610
2002		MANGUERA INFERIOR-RAD. A TUBO	21891
BANDA-VENT	K100465	MANGUERA SUPERIOR-RAD. A TUBO	21135
MANGUERA INFERIOR-TUBO A RAD.	21135	MANGUERA INFERIOR-MOTOR A TUBO	21891
MANGUERA SUPERIOR-TUBO A RAD.	21135	MANGUERA SILICÓN-MOTOR A TUBO	SIH250363C
BANDA-TOMA DE FUERZA-AA	9405	MANGUERA SUPERIOR-MOTOR A TUBO	21135
MANGUERA SILICÓN-MOTOR A TUBO	SIH250363C	BANDA-ALT-VENT	K120870
BANDA-BA	K060415	TENSOR-ALT-VENT	38587
BANDA-ALT	2/9447PB	POLEA-AA	36223
BANDA-ALT	9447	2012	
TERMOSTATO-190°	33579	BANDA-TOMA DE FUERZA-AA	K060637
TERMOSTATO-180°	33576	TENSOR-TOMA DE FUERZA-AA	38610
TERMOSTATO-180°	33578	MANGUERA INFERIOR-RAD. A TUBO	21891
TERMOSTATO-170°	33577	MANGUERA SUPERIOR-RAD. A TUBO	21135
2001		MANGUERA INFERIOR-MOTOR A TUBO	21891
BANDA-VENT	K100465	MANGUERA SILICÓN-MOTOR A TUBO	SIH250363C
MANGUERA INFERIOR-TUBO A RAD.	21135	MANGUERA SUPERIOR-MOTOR A TUBO	21135
MANGUERA SUPERIOR-TUBO A RAD.	21135	BANDA-ALT-VENT	K120870
BANDA-TOMA DE FUERZA-AA	9405	TENSOR-ALT-VENT	38587
MANGUERA SILICÓN-MOTOR A TUBO	SIH250363C	POLEA-AA	36223
BANDA-BA	K060415	2011	
BANDA-ALT	2/9447PB	BANDA-TOMA DE FUERZA-AA	K060637
BANDA-ALT	9447	TENSOR-TOMA DE FUERZA-AA	38610
TERMOSTATO-190°	33579	MANGUERA INFERIOR-RAD. A TUBO	21891
TERMOSTATO-180°	33576	MANGUERA SUPERIOR-RAD. A TUBO	21135
TERMOSTATO-180°	33578	MANGUERA INFERIOR-MOTOR A TUBO	21891
TERMOSTATO-170°	33577	MANGUERA SILICÓN-MOTOR A TUBO	SIH250363C
2000		MANGUERA SUPERIOR-MOTOR A TUBO	21135
BANDA-VENT	K100465	BANDA-ALT-VENT	K120870
MANGUERA INFERIOR-TUBO A RAD.	21135	TENSOR-ALT-VENT	38587
MANGUERA SUPERIOR-TUBO A RAD.	21135	POLEA-AA	36223
BANDA-TOMA DE FUERZA-AA	9405	2010	
MANGUERA SILICÓN-MOTOR A TUBO	SIH250363C	BANDA-TOMA DE FUERZA-AA	K060637
BANDA-BA	K060415	TENSOR-TOMA DE FUERZA-AA	38610



MASTER SERVICIO PESADO 2014

INTERNATIONAL/
NAVISTAR
9200I

MANGUERA INFERIOR-RAD. A TUBO	21891	TENSOR-TOMA DE FUERZA-AA	38610
MANGUERA SUPERIOR-RAD. A TUBO	21135	MANGUERA INFERIOR-RAD. A TUBO	21891
MANGUERA INFERIOR-MOTOR A TUBO	21891	MANGUERA SUPERIOR-RAD. A TUBO	21135
MANGUERA SUPERIOR-MOTOR A TUBO	21135	MANGUERA SILICÓN-MOTOR A TUBO	SIH250363C
BANDA-ALT-VENT	K120911	MANGUERA SUPERIOR-MOTOR A TUBO	21135
POLEA-ALT-VENT	36165	BANDA-ALT-VENT	K120911
TENSOR-ALT-VENT	38587	POLEA-ALT-VENT	36165
POLEA-AA	36223	TENSOR-ALT-VENT	38587
2009		POLEA-AA	36223
BANDA-TOMA DE FUERZA-AA	K060637	2005	
TENSOR-TOMA DE FUERZA-AA	38610	BANDA-TOMA DE FUERZA-AA	K060637
MANGUERA INFERIOR-RAD. A TUBO	21891	TENSOR-TOMA DE FUERZA-AA	38610
MANGUERA SUPERIOR-RAD. A TUBO	21135	MANGUERA INFERIOR-RAD. A TUBO	21891
MANGUERA INFERIOR-MOTOR A TUBO	21891	MANGUERA SUPERIOR-RAD. A TUBO	21135
MANGUERA SUPERIOR-MOTOR A TUBO	21135	MANGUERA SILICÓN-MOTOR A TUBO	SIH250363C
BANDA-ALT-VENT	K120911	MANGUERA SUPERIOR-MOTOR A TUBO	21135
POLEA-ALT-VENT	36165	BANDA-ALT-VENT	K120911
TENSOR-ALT-VENT	38587	POLEA-ALT-VENT	36165
POLEA-AA	36223	TENSOR-ALT-VENT	38587
2008		POLEA-AA	36223
BANDA-TOMA DE FUERZA-AA	K060637	2004	
TENSOR-TOMA DE FUERZA-AA	38610	MANGUERA INFERIOR-TUBO A RAD.	21891
MANGUERA INFERIOR-RAD. A TUBO	21891	TENSOR-TOMA DE FUERZA-AA	38610
MANGUERA SUPERIOR-RAD. A TUBO	21135	MANGUERA SUPERIOR-RAD. A TUBO	21135
MANGUERA INFERIOR-MOTOR A TUBO	21891	MANGUERA SILICÓN-MOTOR A TUBO	SIH250363C
MANGUERA SUPERIOR-MOTOR A TUBO	21135	MANGUERA SUPERIOR-MOTOR A TUBO	21135
BANDA-ALT-VENT	K120911	BANDA-ALT-VENT	K120901
POLEA-ALT-VENT	36165	POLEA-ALT-VENT	36165
TENSOR-ALT-VENT	38587	TENSOR-ALT-VENT	38587
POLEA-AA	36223	BANDA-AA	K060637
2007		POLEA-AA	36223
BANDA-TOMA DE FUERZA-AA	K060637	2003	
TENSOR-TOMA DE FUERZA-AA	38610	MANGUERA INFERIOR-TUBO A RAD.	21891
MANGUERA INFERIOR-RAD. A TUBO	21891	TENSOR-TOMA DE FUERZA-AA	38610
MANGUERA SUPERIOR-RAD. A TUBO	21135	MANGUERA SUPERIOR-RAD. A TUBO	21135
MANGUERA INFERIOR-MOTOR A TUBO	21891	MANGUERA SILICÓN-MOTOR A TUBO	SIH250363C
MANGUERA SUPERIOR-MOTOR A TUBO	21135	MANGUERA SUPERIOR-MOTOR A TUBO	21135
BANDA-ALT-VENT	K120911	BANDA-ALT-VENT	K120901
POLEA-ALT-VENT	36165	POLEA-ALT-VENT	36165
TENSOR-ALT-VENT	38587	TENSOR-ALT-VENT	38587
POLEA-AA	36223	BANDA-AA	K060637
2006		POLEA-AA	36223
BANDA-TOMA DE FUERZA-AA	K060637	CUMMINS ISM DIESEL	



2007		POLEA DEL TENSOR-	36091
BANDA-TOMA DE FUERZA-AA	K060516	2003	
TENSOR-TOMA DE FUERZA-AA	38505	BANDA-TOMA DE FUERZA-AA	K060516
MANGUERA INFERIOR-RAD. A TUBO	21891	TENSOR-TOMA DE FUERZA-AA	38505
MANGUERA SUPERIOR-RAD. A TUBO	21135	MANGUERA INFERIOR-RAD. A TUBO	21891
MANGUERA SILICÓN-MOTOR A TUBO	SIH250363C	MANGUERA SUPERIOR-RAD. A TUBO	21135
BANDA-ALT-VENT	K080740	MANGUERA SILICÓN-MOTOR A TUBO	SIH250363C
POLEA-ALT-VENT	36308	BANDA-ALT-VENT	K080740
TENSOR-ALT-VENT	38622	POLEA-ALT-VENT	36308
POLEA-AA	36225	TENSOR-ALT-VENT	38521
POLEA DEL TENSOR-	36091	POLEA-AA	36225
2006		POLEA DEL TENSOR-	36091
BANDA-TOMA DE FUERZA-AA	K060516	2002	
TENSOR-TOMA DE FUERZA-AA	38505	BANDA-VENT	K080565
MANGUERA INFERIOR-RAD. A TUBO	21891	MANGUERA INFERIOR-TUBO A RAD.	CHARTER 2 1/2"
MANGUERA SUPERIOR-RAD. A TUBO	21135	MANGUERA SUPERIOR-TUBO A RAD.	21135
MANGUERA SILICÓN-MOTOR A TUBO	SIH250363C	BANDA-TOMA DE FUERZA-ALT	K050336
BANDA-ALT-VENT	K080740	BANDA-TOMA DE FUERZA-AA	TR22485
POLEA-ALT-VENT	36308	MANGUERA INFERIOR-MOTOR A TUBO	21135
TENSOR-ALT-VENT	38622	MANGUERA SUPERIOR-MOTOR A TUBO	CHARTER 2 1/2"
POLEA-AA	36225	2001	
POLEA DEL TENSOR-	36091	BANDA-VENT	K080565
2005		MANGUERA INFERIOR-TUBO A RAD.	CHARTER 2 1/2"
BANDA-TOMA DE FUERZA-AA	K060516	MANGUERA SUPERIOR-TUBO A RAD.	21135
TENSOR-TOMA DE FUERZA-AA	38505	BANDA-TOMA DE FUERZA-ALT	K050336
MANGUERA INFERIOR-RAD. A TUBO	21891	BANDA-TOMA DE FUERZA-AA	TR22485
MANGUERA SUPERIOR-RAD. A TUBO	21135	MANGUERA INFERIOR-MOTOR A TUBO	21135
MANGUERA SILICÓN-MOTOR A TUBO	SIH250363C	MANGUERA SUPERIOR-MOTOR A TUBO	CHARTER 2 1/2"
BANDA-ALT-VENT	K080740	2000	
POLEA-ALT-VENT	36308	BANDA-VENT	K080565
TENSOR-ALT-VENT	38622	MANGUERA SILICÓN-TUBO A RAD.	SIH250363C
POLEA-AA	36225	MANGUERA SUPERIOR-TUBO A RAD.	21135
POLEA DEL TENSOR-	36091	BANDA-TOMA DE FUERZA-ALT	K050336
2004		BANDA-TOMA DE FUERZA-AA	TR22485
BANDA-TOMA DE FUERZA-AA	K060516	MANGUERA INFERIOR-MOTOR A TUBO	21135
TENSOR-TOMA DE FUERZA-AA	38505	MANGUERA SILICÓN-MOTOR A TUBO	SIH250363C
MANGUERA INFERIOR-RAD. A TUBO	21891	CATERPILLAR C16 DIESEL	
MANGUERA SUPERIOR-RAD. A TUBO	21135	2003	
MANGUERA SILICÓN-MOTOR A TUBO	SIH250363C	BANDA-VENT-AA	K060500
BANDA-ALT-VENT	K080740	MANGUERA INFERIOR-TUBO A RAD.	21135
POLEA-ALT-VENT	36308	MANGUERA SUPERIOR-TUBO A RAD.	21135
TENSOR-ALT-VENT	38521	MANGUERA SILICÓN-MOTOR A TUBO	SIH250363C
POLEA-AA	36225	BANDA-ALT-VENT	K100771



TERMOSTATO-190°	33579	MANGUERA SILICÓN-RAD. A TUBO	SIH250363C
TERMOSTATO-180°	33576	MANGUERA SILICÓN-MOTOR A TUBO	SIH250363C
TERMOSTATO-180°	33578	MANGUERA SUPERIOR-MOTOR A TUBO	21135
TERMOSTATO-170°	33577	POLEA-MOTOR	36269
CATERPILLAR C15 DIESEL		POLEA-MOTOR	36341
2004		BANDA-ALT-VENT-AA	K081000
BANDA-VENT-AA	K060500	TENSOR-ALT-VENT-AA	38590
MANGUERA INFERIOR-TUBO A RAD.	21135	TERMOSTATO-190°	33579
MANGUERA SUPERIOR-TUBO A RAD.	21135	TERMOSTATO-180°	33576
MANGUERA SILICÓN-MOTOR A TUBO	SIH250363C	TERMOSTATO-180°	33578
BANDA-ALT-VENT	K100771	TERMOSTATO-170°	33577
TERMOSTATO-190°	33579	TAPÓN DE RADIADOR-(10 LBS) SIN PALANCA	31567
TERMOSTATO-180°	33576	POLEA DEL TENSOR-	36164
TERMOSTATO-180°	33578	2006	
TERMOSTATO-170°	33577	MANGUERA INFERIOR-RAD. A TUBO	21891
2003		MANGUERA SILICÓN-RAD. A TUBO	SIH250363C
BANDA-VENT-AA	K060500	MANGUERA SILICÓN-MOTOR A TUBO	SIH250363C
MANGUERA INFERIOR-TUBO A RAD.	21135	MANGUERA SUPERIOR-MOTOR A TUBO	21135
MANGUERA SUPERIOR-TUBO A RAD.	21135	POLEA-MOTOR	36269
MANGUERA SILICÓN-MOTOR A TUBO	SIH250363C	POLEA-MOTOR	36341
BANDA-ALT-VENT	K100771	BANDA-ALT-VENT-AA	K081000
TERMOSTATO-190°	33579	TENSOR-ALT-VENT-AA	38590
TERMOSTATO-180°	33576	TERMOSTATO-190°	33579
TERMOSTATO-180°	33578	TERMOSTATO-180°	33576
TERMOSTATO-170°	33577	TERMOSTATO-180°	33578
CATERPILLAR C13 DIESEL		TERMOSTATO-170°	33577
2008		TAPÓN DE RADIADOR-(10 LBS) SIN PALANCA	31567
MANGUERA INFERIOR-RAD. A TUBO	21891	POLEA DEL TENSOR-	36164
MANGUERA SILICÓN-RAD. A TUBO	SIH250363C	2005	
MANGUERA SILICÓN-MOTOR A TUBO	SIH250363C	MANGUERA INFERIOR-RAD. A TUBO	21891
MANGUERA SUPERIOR-MOTOR A TUBO	21135	MANGUERA SILICÓN-RAD. A TUBO	SIH250363C
POLEA-MOTOR	36269	MANGUERA SILICÓN-MOTOR A TUBO	SIH250363C
POLEA-MOTOR	36341	MANGUERA SUPERIOR-MOTOR A TUBO	21135
BANDA-ALT-VENT-AA	K081000	POLEA-MOTOR	36269
TENSOR-ALT-VENT-AA	38590	POLEA-MOTOR	36341
TERMOSTATO-190°	33579	BANDA-ALT-VENT-AA	K081000
TERMOSTATO-180°	33576	TENSOR-ALT-VENT-AA	38590
TERMOSTATO-180°	33578	TERMOSTATO-190°	33579
TERMOSTATO-170°	33577	TERMOSTATO-180°	33576
TAPÓN DE RADIADOR-(10 LBS) SIN PALANCA	31567	TERMOSTATO-180°	33578
POLEA DEL TENSOR-	36164	TERMOSTATO-170°	33577
2007		TAPÓN DE RADIADOR-(10 LBS) SIN PALANCA	31567
MANGUERA INFERIOR-RAD. A TUBO	21891		



MASTER SERVICIO PESADO 2014

INTERNATIONAL/
NAVISTAR
92001

POLEA DEL TENSOR-	36164	TERMOSTATO-180°	33578
2004		TERMOSTATO-170°	33577
MANGUERA INFERIOR-RAD. A TUBO	21891	2002	
MANGUERA SILICÓN-RAD. A TUBO	SIH250363C	BANDA-VENT-AA	2/9463PB
MANGUERA SILICÓN-MOTOR A TUBO	SIH250363C	BANDA-VENT-AA	9463
MANGUERA SUPERIOR-MOTOR A TUBO	21135	MANGUERA SILICÓN-TUBO A RAD.	SIH250363C
POLEA-MOTOR	36269	MANGUERA INFERIOR-RAD. A TUBO	21135
POLEA-MOTOR	36341	MANGUERA INFERIOR-MOTOR A TUBO	21891
BANDA-ALT-VENT-AA	K081000	MANGUERA SUPERIOR-MOTOR A TUBO	21135
TENSOR-ALT-VENT-AA	38590	BANDA-ALT-VENT	K080733
TERMOSTATO-190°	33579	TERMOSTATO-190°	33579
TERMOSTATO-180°	33576	TERMOSTATO-180°	33576
TERMOSTATO-180°	33578	TERMOSTATO-180°	33578
TERMOSTATO-170°	33577	TERMOSTATO-170°	33577
TAPÓN DE RADIADOR-(10 LBS) SIN PALANCA	31567	2001	
POLEA DEL TENSOR-	36164	BANDA-VENT-AA	2/9463PB
CATERPILLAR C12 DIESEL		BANDA-VENT-AA	9463
2004		MANGUERA SILICÓN-TUBO A RAD.	SIH250363C
BANDA-VENT-AA	K060523	MANGUERA INFERIOR-RAD. A TUBO	21135
POLEA DEL TENSOR-VENT-AA	36091	MANGUERA INFERIOR-MOTOR A TUBO	21891
TENSOR-VENT-AA	38507	MANGUERA SUPERIOR-MOTOR A TUBO	21135
MANGUERA INFERIOR-RAD. A TUBO	21891	BANDA-ALT-VENT	K080733
MANGUERA SUPERIOR-RAD. A TUBO	21135	TERMOSTATO-190°	33579
MANGUERA SILICÓN-MOTOR A RAD.	SIH250363C	TERMOSTATO-180°	33576
MANGUERA SUPERIOR-MOTOR A RAD.	21135	TERMOSTATO-180°	33578
BANDA-ALT-VENT	K080915	TERMOSTATO-170°	33577
POLEA-ALT-VENT	36091	2000	
TENSOR-ALT-VENT	38506	BANDA-VENT-AA	2/9463PB
TERMOSTATO-190°	33579	BANDA-VENT-AA	9463
TERMOSTATO-180°	33576	MANGUERA SILICÓN-TUBO A RAD.	SIH250363C
TERMOSTATO-180°	33578	MANGUERA INFERIOR-RAD. A TUBO	21135
TERMOSTATO-170°	33577	MANGUERA INFERIOR-MOTOR A TUBO	21891
2003		MANGUERA SUPERIOR-MOTOR A TUBO	21135
BANDA-VENT-AA	2/9463PB	BANDA-ALT-VENT	K080733
BANDA-VENT-AA	9463	TERMOSTATO-190°	33579
MANGUERA SILICÓN-TUBO A RAD.	SIH250363C	TERMOSTATO-180°	33576
MANGUERA INFERIOR-RAD. A TUBO	21135	TERMOSTATO-180°	33578
MANGUERA INFERIOR-MOTOR A TUBO	21891	TERMOSTATO-170°	33577
MANGUERA SUPERIOR-MOTOR A TUBO	21135	CATERPILLAR C10 DIESEL	
BANDA-ALT-VENT	K080733	2004	
POLEA-ALT-VENT	36091	BANDA-VENT-AA	K060523
TERMOSTATO-190°	33579	POLEA DEL TENSOR-VENT-AA	36091
TERMOSTATO-180°	33576	TENSOR-VENT-AA	38507



MANGUERA INFERIOR-RAD. A TUBO	21891	TERMOSTATO-190°	33579
MANGUERA SUPERIOR-RAD. A TUBO	21135	TERMOSTATO-180°	33576
MANGUERA SILICÓN-MOTOR A RAD.	SIH250363C	TERMOSTATO-180°	33578
MANGUERA SUPERIOR-MOTOR A RAD.	21135	TERMOSTATO-170°	33577
BANDA-ALT-VENT	K080915	2000	
POLEA-ALT-VENT	36091	BANDA-VENT-AA	2/9463PB
TENSOR-ALT-VENT	38506	BANDA-VENT-AA	9463
TERMOSTATO-190°	33579	MANGUERA SILICÓN-TUBO A RAD.	SIH250363C
TERMOSTATO-180°	33576	MANGUERA INFERIOR-RAD. A TUBO	21135
TERMOSTATO-180°	33578	MANGUERA INFERIOR-MOTOR A TUBO	21891
TERMOSTATO-170°	33577	MANGUERA SUPERIOR-MOTOR A TUBO	21135
2003		BANDA-ALT-VENT	K080733
BANDA-VENT-AA	2/9463PB	TERMOSTATO-190°	33579
BANDA-VENT-AA	9463	TERMOSTATO-180°	33576
MANGUERA SILICÓN-TUBO A RAD.	SIH250363C	TERMOSTATO-180°	33578
MANGUERA INFERIOR-RAD. A TUBO	21135	TERMOSTATO-170°	33577
MANGUERA INFERIOR-MOTOR A TUBO	21891	CATERPILLAR 3406 DIESEL	
MANGUERA SUPERIOR-MOTOR A TUBO	21135	2003	
BANDA-ALT-VENT	K080733	TERMOSTATO-190°	33579
TERMOSTATO-190°	33579	TERMOSTATO-180°	33576
TERMOSTATO-180°	33576	TERMOSTATO-180°	33578
TERMOSTATO-180°	33578	TERMOSTATO-170°	33577
TERMOSTATO-170°	33577	2002	
2002		TERMOSTATO-190°	33579
BANDA-VENT-AA	2/9463PB	TERMOSTATO-180°	33576
BANDA-VENT-AA	9463	TERMOSTATO-180°	33578
MANGUERA SILICÓN-TUBO A RAD.	SIH250363C	TERMOSTATO-170°	33577
MANGUERA INFERIOR-RAD. A TUBO	21135	9300	
MANGUERA INFERIOR-MOTOR A TUBO	21891	DETROIT DIESEL SERIE 60	
MANGUERA SUPERIOR-MOTOR A TUBO	21135	1998	
BANDA-ALT-VENT	K080733	BANDA-VENT	K100570
TERMOSTATO-190°	33579	BANDA-VENT	K100640
TERMOSTATO-180°	33576	MANGUERA SILICÓN-TUBO A RAD.	SIH250363C
TERMOSTATO-180°	33578	MANGUERA SILICÓN-MOTOR A TUBO	SIH250363C
TERMOSTATO-170°	33577	BANDA-ALT	2/9313PB
2001		BANDA-ALT	K060450
BANDA-VENT-AA	2/9463PB	BANDA-AA	K060490
BANDA-VENT-AA	9463	TERMOSTATO-190°	33599
MANGUERA SILICÓN-TUBO A RAD.	SIH250363C	DETROIT DIESEL 6 CIL, 12.7 L DIESEL	
MANGUERA INFERIOR-RAD. A TUBO	21135	1997	
MANGUERA INFERIOR-MOTOR A TUBO	21891	BANDA-VENT	K100570
MANGUERA SUPERIOR-MOTOR A TUBO	21135	BANDA-VENT	K100640
BANDA-ALT-VENT	K080733	MANGUERA SILICÓN-TUBO A RAD.	SIH250363C



MASTER SERVICIO PESADO 2014

INTERNATIONAL/
NAVISTAR
9300

MANGUERA SILICÓN-MOTOR A TUBO	SIH250363C	MANGUERA SILICÓN-MOTOR A TUBO	SIH250363C
BANDA-ALT	2/9313PB	BANDA-ALT	2/9313PB
BANDA-ALT	K060450	BANDA-ALT	K060450
BANDA-AA	K060490	BANDA-AA	K060490
1996		TERMOSTATO-190°	33599
BANDA-VENT	K100570	CUMMINS N14 DIESEL	
BANDA-VENT	K100640	1999	
MANGUERA SILICÓN-TUBO A RAD.	SIH250363C	BANDA-VENT	K100510
MANGUERA SILICÓN-MOTOR A TUBO	SIH250363C	MANGUERA SILICÓN-TUBO A RAD.	SIH250363C
BANDA-ALT	2/9313PB	MANGUERA SILICÓN-MOTOR A TUBO	SIH250363C
BANDA-ALT	K060450	MANGUERA SUPERIOR-MOTOR A TUBO	21135
BANDA-AA	K060490	BANDA-BA	K060415
1995		BANDA-ALT	2/9447PB
BANDA-VENT	K100570	BANDA-ALT	9447
BANDA-VENT	K100640	TERMOSTATO-190°	33579
MANGUERA SILICÓN-TUBO A RAD.	SIH250363C	TERMOSTATO-180°	33576
MANGUERA SILICÓN-MOTOR A TUBO	SIH250363C	TERMOSTATO-180°	33578
BANDA-ALT	2/9313PB	TERMOSTATO-170°	33577
BANDA-ALT	K060450	BANDA-	9405
BANDA-AA	K060490	1998	
DETROIT DIESEL 6 CIL, 11.1 L DIESEL		BANDA-VENT	K100510
1997		MANGUERA SILICÓN-TUBO A RAD.	SIH250363C
BANDA-VENT	K100570	MANGUERA SILICÓN-MOTOR A TUBO	SIH250363C
BANDA-VENT	K100640	MANGUERA SUPERIOR-MOTOR A TUBO	21135
MANGUERA SILICÓN-TUBO A RAD.	SIH250363C	BANDA-BA	K060415
MANGUERA SILICÓN-MOTOR A TUBO	SIH250363C	BANDA-ALT	2/9447PB
BANDA-ALT	2/9313PB	BANDA-ALT	9447
BANDA-ALT	K060450	TERMOSTATO-190°	33579
BANDA-AA	K060490	TERMOSTATO-180°	33576
TERMOSTATO-190°	33599	TERMOSTATO-180°	33578
1996		TERMOSTATO-170°	33577
BANDA-VENT	K100570	BANDA-	9405
BANDA-VENT	K100640	1997	
MANGUERA SILICÓN-TUBO A RAD.	SIH250363C	BANDA-VENT	K100456
MANGUERA SILICÓN-MOTOR A TUBO	SIH250363C	BANDA-VENT	K100510
BANDA-ALT	2/9313PB	MANGUERA SILICÓN-TUBO A RAD.	SIH250363C
BANDA-ALT	K060450	MANGUERA SILICÓN-MOTOR A TUBO	SIH250363C
BANDA-AA	K060490	BANDA-BA	K060415
TERMOSTATO-190°	33599	BANDA-ALT	2/9447PB
1995		BANDA-ALT	2/9463PB
BANDA-VENT	K100570	BANDA-ALT	9447
BANDA-VENT	K100640	BANDA-ALT	9463
MANGUERA SILICÓN-TUBO A RAD.	SIH250363C	TERMOSTATO-190°	33579



MASTER SERVICIO PESADO 2014

INTERNATIONAL/
NAVISTAR
9300

TERMOSTATO-180°	33576	1997	
TERMOSTATO-180°	33578	BANDA-VENT	K080605
TERMOSTATO-170°	33577	MANGUERA SILICÓN-TUBO A RAD.	SIH250363C
1996		MANGUERA SILICÓN-MOTOR A TUBO	SIH250363C
TERMOSTATO-190°	33579	BANDA-ALT	K050336
TERMOSTATO-180°	33576	TERMOSTATO-190°	33579
TERMOSTATO-180°	33578	TERMOSTATO-180°	33576
TERMOSTATO-170°	33577	TERMOSTATO-180°	33578
1995		TERMOSTATO-170°	33577
BANDA-VENT-C/VENT CLUTCH EVANS, HORTON, ROCKFORD	TR28514	BANDA-	TR22485
BANDA-VENT-C/VENT CLUTCH BENDIX, FACET, KYSOR, WESTINHOUSE	TR28510	1996	
BANDA-VENT- OPCIONAL	TR28480	BANDA-VENT	K080605
BANDA-VENT	2/TR28480PB	MANGUERA SILICÓN-TUBO A RAD.	SIH250363C
BANDA-VENT	TR28550	MANGUERA SILICÓN-MOTOR A TUBO	SIH250363C
BANDA-C/DOBLE COMP	2/9470PB	BANDA-ALT	K050336
BANDA-C/DOBLE COMP	9330	TERMOSTATO-190°	33579
BANDA-C/DOBLE COMP	9470	TERMOSTATO-180°	33576
BANDA-C/COMP TECUMSEH	2/9430PB	TERMOSTATO-180°	33578
BANDA-C/COMP TECUMSEH	9430	TERMOSTATO-170°	33577
BANDA-BA	K040425	BANDA-	TR22485
BANDA-BA	K040430	1995	
BANDA-BA	K060435	TERMOSTATO-190°	33579
BANDA-ALT	2/9447PB	TERMOSTATO-180°	33576
BANDA-ALT	2/9463PB	TERMOSTATO-180°	33578
BANDA-ALT	9447	TERMOSTATO-170°	33577
BANDA-ALT	9463	CATERPILLAR C12 DIESEL	
TERMOSTATO-190°	33579	1998	
TERMOSTATO-180°	33576	BANDA-VENT-AA	2/9463PB
TERMOSTATO-180°	33578	BANDA-VENT-AA	9463
TERMOSTATO-170°	33577	MANGUERA SILICÓN-TUBO A RAD.	SIH250363C
BANDA-	9405	MANGUERA INFERIOR-RAD. A TUBO	21135
BANDA-	9420	MANGUERA INFERIOR-MOTOR A TUBO	21891
CUMMINS M11 DIESEL		MANGUERA SUPERIOR-MOTOR A TUBO	21135
1999		BANDA-ALT-VENT	K080733
TERMOSTATO-190°	33579	TERMOSTATO-190°	33579
TERMOSTATO-180°	33576	TERMOSTATO-180°	33576
TERMOSTATO-180°	33578	TERMOSTATO-180°	33578
TERMOSTATO-170°	33577	TERMOSTATO-170°	33577
1998		1997	
TERMOSTATO-190°	33579	BANDA-VENT-AA	2/9463PB
TERMOSTATO-180°	33576	BANDA-VENT-AA	9463
TERMOSTATO-180°	33578	MANGUERA SILICÓN-TUBO A RAD.	SIH250363C
TERMOSTATO-170°	33577	MANGUERA INFERIOR-RAD. A TUBO	21135



MASTER SERVICIO PESADO 2014

INTERNATIONAL/
NAVISTAR
9300

MANGUERA INFERIOR-MOTOR A TUBO	21891	MANGUERA SUPERIOR-MOTOR A TUBO	21135
MANGUERA SUPERIOR-MOTOR A TUBO	21135	BANDA-ALT-VENT	K080733
BANDA-ALT-VENT	K080733	TERMOSTATO-190°	33579
TERMOSTATO-190°	33579	TERMOSTATO-180°	33576
TERMOSTATO-180°	33576	TERMOSTATO-180°	33578
TERMOSTATO-180°	33578	TERMOSTATO-170°	33577
TERMOSTATO-170°	33577	1996	
1996		BANDA-VENT-AA	2/9463PB
BANDA-VENT-AA	2/9463PB	BANDA-VENT-AA	9463
BANDA-VENT-AA	9463	MANGUERA SILICÓN-TUBO A RAD.	SIH250363C
MANGUERA SILICÓN-TUBO A RAD.	SIH250363C	MANGUERA INFERIOR-RAD. A TUBO	21135
MANGUERA INFERIOR-RAD. A TUBO	21135	MANGUERA INFERIOR-MOTOR A TUBO	21891
MANGUERA INFERIOR-MOTOR A TUBO	21891	MANGUERA SUPERIOR-MOTOR A TUBO	21135
MANGUERA SUPERIOR-MOTOR A TUBO	21135	BANDA-ALT-VENT	K080720
BANDA-ALT-VENT	K080720	TERMOSTATO-190°	33579
TERMOSTATO-190°	33579	TERMOSTATO-180°	33576
TERMOSTATO-180°	33576	TERMOSTATO-180°	33578
TERMOSTATO-180°	33578	TERMOSTATO-170°	33577
TERMOSTATO-170°	33577	CATERPILLAR 3406 DIESEL	
CATERPILLAR C10 DIESEL		1999	
1999		TERMOSTATO-190°	33579
TERMOSTATO-190°	33579	TERMOSTATO-180°	33576
TERMOSTATO-180°	33576	TERMOSTATO-180°	33578
TERMOSTATO-180°	33578	TERMOSTATO-170°	33577
TERMOSTATO-170°	33577	1998	
1998		BANDA-VENT-AA	K060500
BANDA-VENT-AA	2/9463PB	MANGUERA SILICÓN-TUBO A RAD.	SIH250363C
BANDA-VENT-AA	9463	MANGUERA SILICÓN-MOTOR A TUBO	SIH250363C
MANGUERA SILICÓN-TUBO A RAD.	SIH250363C	MANGUERA SILICÓN-MOTOR A TUBO	SIH300363C
MANGUERA INFERIOR-RAD. A TUBO	21135	BANDA-ALT-VENT	K100852
MANGUERA INFERIOR-MOTOR A TUBO	21891	TERMOSTATO-190°	33579
MANGUERA SUPERIOR-MOTOR A TUBO	21135	TERMOSTATO-180°	33576
BANDA-ALT-VENT	K080733	TERMOSTATO-180°	33578
TERMOSTATO-190°	33579	TERMOSTATO-170°	33577
TERMOSTATO-180°	33576	1997	
TERMOSTATO-180°	33578	BANDA-VENT-AA	K060425
TERMOSTATO-170°	33577	MANGUERA SILICÓN-TUBO A RAD.	SIH250363C
1997		MANGUERA SILICÓN-MOTOR A TUBO	SIH250363C
BANDA-VENT-AA	2/9463PB	MANGUERA SILICÓN-MOTOR A TUBO	SIH300363C
BANDA-VENT-AA	9463	BANDA-ALT-VENT	K100852
MANGUERA SILICÓN-TUBO A RAD.	SIH250363C	TERMOSTATO-190°	33579
MANGUERA INFERIOR-RAD. A TUBO	21135	TERMOSTATO-180°	33576
MANGUERA INFERIOR-MOTOR A TUBO	21891	TERMOSTATO-180°	33578



TERMOSTATO-170°	33577	BANDA-ALT-VENT-C/ALT DELCO, C/VENT CLUTCH HORTON/KYSOR/SCHWITZER	K080738
1996		POLEA-ALT-VENT	36091
MANGUERA SILICÓN-TUBO A RAD.	SIH250363C	TENSOR-ALT-VENT	38506
MANGUERA SILICÓN-MOTOR A TUBO	SIH250363C	TERMOSTATO-190°	33579
MANGUERA SILICÓN-MOTOR A TUBO	SIH300363C	TERMOSTATO-180°	33576
BANDA-ALT-VENT	K100852	TERMOSTATO-180°	33578
BANDA-AA	K060425	TERMOSTATO-170°	33577
TERMOSTATO-190°	33579	BANDA-	9525
TERMOSTATO-180°	33576	9400	
TERMOSTATO-180°	33578	DETROIT DIESEL SERIE 60	
TERMOSTATO-170°	33577	1999	
1995		BANDA-VENT	K100540
BANDA-VENT C/BENTIX, ROCKFORD, SCHWITZER	2/TR22570PB	BANDA-VENT	K100570
MANGUERA SILICÓN-TUBO A RAD.	SIH250363C	BANDA-VENT	K100640
MANGUERA SILICÓN-MOTOR A TUBO	SIH250363C	POLEA DEL TENSOR-VENT	36092
MANGUERA SILICÓN-MOTOR A TUBO	SIH300363C	TENSOR-VENT	38519
BANDA-ALT-VENT-C/VENT ROCKFORD	TR22553	MANGUERA INFERIOR-TUBO A RAD.	21135
BANDA-ALT-VENT-C/VENT CLUTCH HORTON, KYSOR	TR22607	MANGUERA SUPERIOR-TUBO A RAD.	21135
BANDA-ALT-VENT-C/VENT CLUTCH HORTON, KYSOR	TR22676	MANGUERA SILICÓN-MOTOR A TUBO	SIH250363C
BANDA-ALT-VENT-C/VENT CLUTCH BENDIX	TR22676	MANGUERA SUPERIOR-MOTOR A TUBO	21891
BANDA-ALT-VENT C/FACET, HORTON	2/TR22553PB	BANDA-ALT	K060450
BANDA-ALT-VENT C/FACET, HORTON	2/TR22570PB	BANDA-ALT	K060455
BANDA-ALT-VENT C/FACET, HORTON	TR22553	BANDA-AA	K060340
BANDA-ALT-VENT C/FACET, HORTON	TR22570	BANDA-AA	K060490
BANDA-ALT-VENT C/ BENDIX, ROCKFORD, SCHWITZER	TR22570	BANDA-AA	K060547
BANDA-AA	K060425	TERMOSTATO-190°	33599
TERMOSTATO-190°	33579	1998	
TERMOSTATO-180°	33576	BANDA-VENT	K100540
TERMOSTATO-180°	33578	BANDA-VENT	K100570
TERMOSTATO-170°	33577	BANDA-VENT	K100640
CATERPILLAR 3176 DIESEL		POLEA DEL TENSOR-VENT	36092
1996		TENSOR-VENT	38519
TERMOSTATO-190°	33579	MANGUERA SILICÓN-TUBO A RAD.	SIH250363C
TERMOSTATO-180°	33576	MANGUERA SILICÓN-MOTOR A TUBO	SIH250363C
TERMOSTATO-180°	33578	BANDA-ALT	2/9313PB
TERMOSTATO-170°	33577	BANDA-ALT	9313
1995		BANDA-ALT	K060450
MANGUERA INFERIOR-RAD. A TUBO	24436	BANDA-ALT	K060455
MANGUERA SILICÓN-RAD. A TUBO	SIH200363C	BANDA-AA	K060490
MANGUERA SILICÓN-MOTOR A TUBO	SIH200363C	BANDA-AA	K060547
MANGUERA SILICÓN-MOTOR A TUBO	SIH250363C	TERMOSTATO-190°	33599
BANDA-ALT-VENT-C/VENT CLUTCH KYSOR	K080720	1997	
BANDA-ALT-VENT-C/VENT CLUTCH HORTON, KYSOR, SCHWITZER, C/ALT LEECE NEVILLE	K080733		



MASTER SERVICIO PESADO 2014

INTERNATIONAL/
NAVISTAR
9400

BANDA-VENT	K100540	MANGUERA SILICÓN-MOTOR A TUBO	SIH250363C
BANDA-VENT	K100570	BANDA-ALT	2/9313PB
BANDA-VENT	K100640	BANDA-ALT	9313
POLEA DEL TENSOR-VENT	36092	BANDA-ALT	K060455
TENSOR-VENT	38519	BANDA-AA	K060490
MANGUERA SILICÓN-TUBO A RAD.	SIH250363C	TERMOSTATO-190°	33599
MANGUERA SILICÓN-MOTOR A TUBO	SIH250363C	1995	
BANDA-ALT	2/9313PB	BANDA-VENT-C/VENT CLUTCH KYSOR	K100607
BANDA-ALT	9313	BANDA-VENT-C/VENT CLUTCH HORTON	K100640
BANDA-ALT	K060450	BANDA-VENT-C/VENT CLUTCH FACET, KYSOR, SCHWITZER	K100540
BANDA-ALT	K060455	POLEA DEL TENSOR-VENT	36092
BANDA-AA	K060490	TENSOR-VENT	38519
BANDA-AA	K060547	MANGUERA SILICÓN-TUBO A RAD.	SIH250363C
TERMOSTATO-190°	33599	MANGUERA SILICÓN-MOTOR A TUBO	SIH250363C
1996		BANDA-ALT-C/ALT LEECE NEVILLE	9325
BANDA-VENT	K100540	BANDA-ALT C/ALT DELCO	2/9313PB
BANDA-ALT-BA	8324 GS	BANDA-ALT C/ALT DELCO	9313
BANDA-ALT	2/9313PB	BANDA-AA	K060470
BANDA-AA	K060547	TERMOSTATO-190°	33599
1995		DETROIT DIESEL 6 CIL, 11.1 L DIESEL	
BANDA-VENT	K100540	1996	
BANDA-ALT	2/9313PB	BANDA-VENT	K100570
BANDA-AA	K060547	BANDA-VENT	K100637
1994		BANDA-VENT	K100640
BANDA-VENT	K100540	POLEA DEL TENSOR-VENT	36092
BANDA-ALT	2/9313PB	TENSOR-VENT	38519
BANDA-AA	K060547	MANGUERA SILICÓN-TUBO A RAD.	SIH250363C
1993		MANGUERA SILICÓN-MOTOR A TUBO	SIH250363C
BANDA-VENT	K100540	BANDA-ALT	2/9313PB
BANDA-ALT	2/9313PB	BANDA-ALT	9313
BANDA-AA	K060547	BANDA-ALT	K060455
1992		BANDA-AA	K060490
BANDA-VENT	K100540	TERMOSTATO-190°	33599
BANDA-ALT	2/9313PB	1995	
BANDA-AA	K060547	BANDA-VENT-C/VENT CLUTCH KYSOR	K100607
DETROIT DIESEL 6 CIL, 12.7 L DIESEL		BANDA-VENT-C/VENT CLUTCH HORTON	K100640
1996		BANDA-VENT-C/VENT CLUTCH FACET, KYSOR, SCHWITZER	K100540
BANDA-VENT	K100570	POLEA DEL TENSOR-VENT	36092
BANDA-VENT	K100637	TENSOR-VENT	38519
BANDA-VENT	K100640	MANGUERA SILICÓN-TUBO A RAD.	SIH250363C
POLEA DEL TENSOR-VENT	36092	MANGUERA SILICÓN-MOTOR A TUBO	SIH250363C
TENSOR-VENT	38519	BANDA-ALT-C/ALT LEECE NEVILLE	9325
MANGUERA SILICÓN-TUBO A RAD.	SIH250363C	BANDA-ALT C/ALT DELCO	2/9313PB



MASTER SERVICIO PESADO 2014

INTERNATIONAL/
NAVISTAR
9400

BANDA-ALT C/ALT DELCO	9313	BANDA-ALT	9447
BANDA-AA	K060470	BANDA-ALT	9463
TERMOSTATO-190°	33599	TERMOSTATO-190°	33579
CUMMINS NTC 400		TERMOSTATO-180°	33576
1990		TERMOSTATO-180°	33578
BANDA-VENT	PQ28463	TERMOSTATO-170°	33577
BANDA-BA	K040425	1996	
BANDA-ALT	PQ17450	BANDA-VENT-COMPRESOR	PQ28463
BANDA-ALT	PQ28429	BANDA-VENT-C/VENT CLUTCH EVANS, HORTON, ROCKFORD	TR28514
CUMMINS N14 DIESEL		BANDA-VENT-C/VENT CLUTCH BENDIX, FACET, KYSOR, WESTINHOUSE	TR28510
1999		BANDA-COMPRESOR	PQ17400
BANDA-VENT	K100465	BANDA-BA	K060425
MANGUERA INFERIOR-TUBO A RAD.	21135	BANDA-BA	K060435
MANGUERA SUPERIOR-TUBO A RAD.	21135	BANDA-ALT	9447
BANDA-TOMA DE FUERZA-AA	9405	BANDA-ALT	PQ17450
MANGUERA SILICÓN-MOTOR A TUBO	SIH250363C	TERMOSTATO-190°	33579
BANDA-BA	K060415	TERMOSTATO-180°	33576
BANDA-ALT	2/9447PB	TERMOSTATO-180°	33578
BANDA-ALT	9447	TERMOSTATO-170°	33577
TERMOSTATO-190°	33579	BANDA-	9405
TERMOSTATO-180°	33576	1995	
TERMOSTATO-180°	33578	BANDA-VENT-C/VENT CLUTCH EVANS, HORTON, ROCKFORD	TR28514
TERMOSTATO-170°	33577	BANDA-VENT-C/VENT CLUTCH BENDIX, FACET, KYSOR, WESTINHOUSE	TR28510
1998		BANDA-VENT- OPCIONAL	TR28480
BANDA-VENT	K100510	BANDA-VENT	2/TR28480PB
MANGUERA SILICÓN-TUBO A RAD.	SIH250363C	BANDA-VENT	TR28550
MANGUERA SILICÓN-MOTOR A TUBO	SIH250363C	BANDA-C/DOBLE COMP	2/9470PB
BANDA-BA	K060415	BANDA-C/DOBLE COMP	9330
BANDA-ALT	2/9447PB	BANDA-C/DOBLE COMP	9470
BANDA-ALT	9447	BANDA-C/COMP TECUMSEH	2/9430PB
TERMOSTATO-190°	33579	BANDA-C/COMP TECUMSEH	9430
TERMOSTATO-180°	33576	BANDA-BA	K040425
TERMOSTATO-180°	33578	BANDA-BA	K040430
TERMOSTATO-170°	33577	BANDA-BA	K060435
BANDA-	9405	BANDA-ALT	2/9447PB
1997		BANDA-ALT	2/9463PB
BANDA-VENT	K100456	BANDA-ALT	9447
BANDA-VENT	K100510	BANDA-ALT	9463
MANGUERA SILICÓN-TUBO A RAD.	SIH250363C	TERMOSTATO-190°	33579
MANGUERA SILICÓN-MOTOR A TUBO	SIH250363C	TERMOSTATO-180°	33576
BANDA-BA	K060415	TERMOSTATO-180°	33578
BANDA-ALT	2/9447PB	TERMOSTATO-170°	33577
BANDA-ALT	2/9463PB		



BANDA-	9405	TERMOSTATO-170°	33577
BANDA-	9420	CUMMINS ISX DIESEL	
1994		2005	
BANDA-VENT-COMPRESOR	PQ28463	BANDA-TOMA DE FUERZA-AA	K060637
BANDA-COMPRESOR	PQ17400	MANGUERA INFERIOR-RAD. A TUBO	21891
BANDA-BA	K060435	MANGUERA SUPERIOR-RAD. A TUBO	21135
BANDA-ALT	PQ17450	MANGUERA SUPERIOR-MOTOR A TUBO	21135
1993		BANDA-ALT-VENT	K120911
BANDA-VENT	PQ28463	MANGUERA INFERIOR-	CHARTER 2 1/2"
BANDA-VENT	PQ28473	CUMMINS ISM DIESEL	
BANDA-ALT	PQ17460	1999	
BANDA-ALT	PQ28463	BANDA-VENT	K080465
BANDA-AA	PQ17400	BANDA-ALT	K050336
CUMMINS M11 DIESEL		CATERPILLAR C15 DIESEL	
1998		2005	
TERMOSTATO-190°	33579	BANDA-VENT-AA	K060605
TERMOSTATO-180°	33576	MANGUERA SUPERIOR-RAD. A TUBO	21135
TERMOSTATO-180°	33578	MANGUERA SUPERIOR-MOTOR A TUBO	21891
TERMOSTATO-170°	33577	BANDA-ALT-VENT	K080991
1997		TERMOSTATO-175°	33549
BANDA-VENT	K080605	MANGUERA INFERIOR-	CHARTER 2 1/2"
MANGUERA SILICÓN-TUBO A RAD.	SIH250363C	MANGUERA INFERIOR-	CHARTER 3"
MANGUERA SILICÓN-MOTOR A TUBO	SIH250363C	CATERPILLAR C12 DIESEL	
BANDA-ALT	K050336	1999	
TERMOSTATO-190°	33579	BANDA-VENT-AA	2/9463PB
TERMOSTATO-180°	33576	BANDA-VENT-AA	9463
TERMOSTATO-180°	33578	MANGUERA SILICÓN-TUBO A RAD.	SIH250363C
TERMOSTATO-170°	33577	MANGUERA INFERIOR-RAD. A TUBO	21135
BANDA-	TR22485	MANGUERA INFERIOR-MOTOR A TUBO	21891
1996		MANGUERA SUPERIOR-MOTOR A TUBO	21135
BANDA-VENT	K080605	BANDA-ALT-VENT	K080733
MANGUERA SILICÓN-TUBO A RAD.	SIH250363C	TERMOSTATO-190°	33579
MANGUERA SILICÓN-MOTOR A TUBO	SIH250363C	TERMOSTATO-180°	33576
BANDA-ALT	K050336	TERMOSTATO-180°	33578
TERMOSTATO-190°	33579	TERMOSTATO-170°	33577
TERMOSTATO-180°	33576	1998	
TERMOSTATO-180°	33578	BANDA-VENT-AA	2/9463PB
TERMOSTATO-170°	33577	BANDA-VENT-AA	9463
BANDA-	TR22485	MANGUERA SILICÓN-TUBO A RAD.	SIH250363C
1995		MANGUERA INFERIOR-RAD. A TUBO	21135
TERMOSTATO-190°	33579	MANGUERA INFERIOR-MOTOR A TUBO	21891
TERMOSTATO-180°	33576	MANGUERA SUPERIOR-MOTOR A TUBO	21135
TERMOSTATO-180°	33578	BANDA-ALT-VENT	K080733



TERMOSTATO-190°	33579	BANDA-VENT-AA	9463
TERMOSTATO-180°	33576	MANGUERA SILICÓN-TUBO A RAD.	SIH250363C
TERMOSTATO-180°	33578	MANGUERA INFERIOR-RAD. A TUBO	21135
TERMOSTATO-170°	33577	MANGUERA INFERIOR-MOTOR A TUBO	21891
1997		MANGUERA SUPERIOR-MOTOR A TUBO	21135
BANDA-VENT-AA	2/9463PB	BANDA-ALT-VENT	K080733
BANDA-VENT-AA	9463	TERMOSTATO-190°	33579
MANGUERA SILICÓN-TUBO A RAD.	SIH250363C	TERMOSTATO-180°	33576
MANGUERA INFERIOR-RAD. A TUBO	21135	TERMOSTATO-180°	33578
MANGUERA INFERIOR-MOTOR A TUBO	21891	TERMOSTATO-170°	33577
MANGUERA SUPERIOR-MOTOR A TUBO	21135	1997	
BANDA-ALT-VENT	K080733	BANDA-VENT-AA	2/9463PB
TERMOSTATO-190°	33579	BANDA-VENT-AA	9463
TERMOSTATO-180°	33576	MANGUERA SILICÓN-TUBO A RAD.	SIH250363C
TERMOSTATO-180°	33578	MANGUERA INFERIOR-RAD. A TUBO	21135
TERMOSTATO-170°	33577	MANGUERA INFERIOR-MOTOR A TUBO	21891
1996		MANGUERA SUPERIOR-MOTOR A TUBO	21135
BANDA-VENT-AA	2/9463PB	BANDA-ALT-VENT	K080733
BANDA-VENT-AA	9463	TERMOSTATO-190°	33579
MANGUERA SILICÓN-TUBO A RAD.	SIH250363C	TERMOSTATO-180°	33576
MANGUERA INFERIOR-RAD. A TUBO	21135	TERMOSTATO-180°	33578
MANGUERA INFERIOR-MOTOR A TUBO	21891	TERMOSTATO-170°	33577
MANGUERA SUPERIOR-MOTOR A TUBO	21135	1996	
BANDA-ALT-VENT	K080720	BANDA-VENT-AA	2/9463PB
TERMOSTATO-190°	33579	BANDA-VENT-AA	9463
TERMOSTATO-180°	33576	MANGUERA SILICÓN-TUBO A RAD.	SIH250363C
TERMOSTATO-180°	33578	MANGUERA INFERIOR-RAD. A TUBO	21135
TERMOSTATO-170°	33577	MANGUERA INFERIOR-MOTOR A TUBO	21891
CATERPILLAR C10 DIESEL		MANGUERA SUPERIOR-MOTOR A TUBO	21135
1999		BANDA-ALT-VENT	K080720
BANDA-VENT-AA	2/9463PB	TERMOSTATO-190°	33579
BANDA-VENT-AA	9463	TERMOSTATO-180°	33576
MANGUERA SILICÓN-TUBO A RAD.	SIH250363C	TERMOSTATO-180°	33578
MANGUERA INFERIOR-RAD. A TUBO	21135	TERMOSTATO-170°	33577
MANGUERA INFERIOR-MOTOR A TUBO	21891	CATERPILLAR 3406 DIESEL	
MANGUERA SUPERIOR-MOTOR A TUBO	21135	1999	
BANDA-ALT-VENT	K080733	BANDA-VENT-AA	K060500
TERMOSTATO-190°	33579	MANGUERA SILICÓN-TUBO A RAD.	SIH250363C
TERMOSTATO-180°	33576	MANGUERA SUPERIOR-TUBO A RAD.	21135
TERMOSTATO-180°	33578	MANGUERA INFERIOR-MOTOR A TUBO	CHARTER 3"
TERMOSTATO-170°	33577	MANGUERA SILICÓN-MOTOR A TUBO	SIH250363C
1998		BANDA-ALT-VENT	K100771
BANDA-VENT-AA	2/9463PB	TERMOSTATO-190°	33579



TERMOSTATO-180°	33576	BANDA-ALT-VENT C/FACET, HORTON	2/TR22553PB
TERMOSTATO-180°	33578	BANDA-ALT-VENT C/FACET, HORTON	2/TR22570PB
TERMOSTATO-170°	33577	BANDA-ALT-VENT C/FACET, HORTON	TR22553
1998		BANDA-ALT-VENT C/FACET, HORTON	TR22570
BANDA-VENT-AA	K060500	BANDA-ALT-VENT C/ BENDIX, ROCKFORD	TR22570
MANGUERA SILICÓN-TUBO A RAD.	SIH250363C	BANDA-AA	K060425
MANGUERA SILICÓN-MOTOR A TUBO	SIH250363C	TERMOSTATO-190°	33579
MANGUERA SILICÓN-MOTOR A TUBO	SIH300363C	TERMOSTATO-180°	33576
BANDA-ALT-VENT	K100771	TERMOSTATO-180°	33578
TERMOSTATO-190°	33579	TERMOSTATO-170°	33577
TERMOSTATO-180°	33576	CATERPILLAR 3176 DIESEL	
TERMOSTATO-180°	33578	1997	
TERMOSTATO-170°	33577	MANGUERA SILICÓN-RAD. A TUBO	SIH250363C
1997		MANGUERA INFERIOR-MOTOR A TUBO	24436
BANDA-VENT-AA	K060500	MANGUERA SILICÓN-MOTOR A TUBO	SIH200363C
MANGUERA SILICÓN-TUBO A RAD.	SIH250363C	BANDA-ALT-VENT-C/VENT CLUTCH KYSOR	K080720
MANGUERA SILICÓN-MOTOR A TUBO	SIH250363C	BANDA-ALT-VENT-C/VENT CLUTCH HORTON, KYSOR, SCHWITZER, C/ALT LEECE NEVILLE	K080733
MANGUERA SILICÓN-MOTOR A TUBO	SIH300363C	BANDA-ALT-VENT-C/ALT DELCO, C/VENT CLUTCH HORTON/KYSOR/SCHWITZER	K080738
BANDA-ALT-VENT	K100771	POLEA-ALT-VENT	36091
TERMOSTATO-190°	33579	TENSOR-ALT-VENT	38506
TERMOSTATO-180°	33576	TERMOSTATO-190°	33579
TERMOSTATO-180°	33578	TERMOSTATO-180°	33576
TERMOSTATO-170°	33577	TERMOSTATO-180°	33578
1996		TERMOSTATO-170°	33577
MANGUERA SILICÓN-TUBO A RAD.	SIH250363C	1996	
MANGUERA SILICÓN-MOTOR A TUBO	SIH250363C	MANGUERA SILICÓN-RAD. A TUBO	SIH250363C
MANGUERA SILICÓN-MOTOR A TUBO	SIH300363C	MANGUERA INFERIOR-MOTOR A TUBO	24436
BANDA-ALT-VENT	K100771	MANGUERA SILICÓN-MOTOR A TUBO	SIH200363C
BANDA-AA	K060500	BANDA-ALT-VENT-C/VENT CLUTCH KYSOR	K080720
TERMOSTATO-190°	33579	BANDA-ALT-VENT-C/VENT CLUTCH HORTON, KYSOR, SCHWITZER, C/ALT LEECE NEVILLE	K080733
TERMOSTATO-180°	33576	BANDA-ALT-VENT-C/ALT DELCO, C/VENT CLUTCH HORTON/KYSOR/SCHWITZER	K080738
TERMOSTATO-180°	33578	POLEA-ALT-VENT	36091
TERMOSTATO-170°	33577	TENSOR-ALT-VENT	38506
1995		TERMOSTATO-190°	33579
BANDA-VENT C/BENTIX, ROCKFORT, SCHWITZER	2/TR22570PB	TERMOSTATO-180°	33576
MANGUERA SILICÓN-TUBO A TUBO	SIH250363C	TERMOSTATO-180°	33578
MANGUERA SILICÓN-TUBO A RAD.	SIH250363C	TERMOSTATO-170°	33577
MANGUERA SILICÓN-MOTOR A TUBO	SIH250363C	1995	
MANGUERA SILICÓN-MOTOR A TUBO	SIH300363C	MANGUERA SILICÓN-RAD. A TUBO	SIH250363C
BANDA-ALT-VENT-C/VENT ROCKFORD	TR22553	MANGUERA INFERIOR-MOTOR A TUBO	24436
BANDA-ALT-VENT-C/VENT CLUTCH HORTON, KYSOR	TR22607	MANGUERA SILICÓN-MOTOR A TUBO	SIH200363C
BANDA-ALT-VENT-C/VENT CLUTCH HORTON, KYSOR	TR22676	BANDA-ALT-VENT-C/VENT CLUTCH KYSOR	K080720
BANDA-ALT-VENT-C/VENT CLUTCH BENDIX	TR22676	BANDA-ALT-VENT-C/VENT CLUTCH HORTON, KYSOR, SCHWITZER, C/ALT LEECE NEVILLE	K080733



BANDA-ALT-VENT-C/ALT DELCO, C/VENT CLUTCH HORTON/KYSOR/SCHWITZER POLEA-ALT-VENT	K080738 36091
TENSOR-ALT-VENT	38506
TERMOSTATO-190°	33579
TERMOSTATO-180°	33576
TERMOSTATO-180°	33578
TERMOSTATO-170°	33577

9400I

DETROIT DIESEL SERIE 60

2000	
BANDA-VENT	K100540
POLEA DEL TENSOR-VENT	36092
TENSOR-VENT	38519
MANGUERA INFERIOR-TUBO A RAD.	21135
MANGUERA SUPERIOR-TUBO A RAD.	21135
MANGUERA SILICÓN-MOTOR A TUBO	SIH250363C
MANGUERA SUPERIOR-MOTOR A TUBO	21891
BANDA-ALT	K060455
BANDA-AA	K060340
TERMOSTATO-190°	33599

DETROIT DIESEL 6 CIL, 12.7 L DIESEL

2003	
BANDA-VENT	K100540
MANGUERA INFERIOR-RAD. A TUBO	21135
MANGUERA SUPERIOR-RAD. A TUBO	21135
MANGUERA SILICÓN-MOTOR A TUBO	SIH250363C
TERMOSTATO-190°	33599

2002	
BANDA-VENT	K100540
MANGUERA INFERIOR-RAD. A TUBO	21135
MANGUERA SUPERIOR-RAD. A TUBO	21135
MANGUERA SILICÓN-MOTOR A TUBO	SIH250363C
TERMOSTATO-190°	33599

2001	
BANDA-VENT	K100540
POLEA DEL TENSOR-VENT	36092
TENSOR-VENT	38519
MANGUERA INFERIOR-TUBO A RAD.	21135
MANGUERA SUPERIOR-TUBO A RAD.	21135
MANGUERA SILICÓN-MOTOR A TUBO	SIH250363C
MANGUERA SUPERIOR-MOTOR A TUBO	21891
BANDA-ALT	K060455
BANDA-AA	K060340

CUMMINS N14 DIESEL

2003	
MANGUERA INFERIOR-TUBO A RAD.	21135
MANGUERA SUPERIOR-TUBO A RAD.	21135
BANDA-TOMA DE FUERZA-VENT	K100465
BANDA-TOMA DE FUERZA-BA	K060425
BANDA-TOMA DE FUERZA-AA	9405
MANGUERA INFERIOR-MOTOR A TUBO	CHARTER 2 1/2"
MANGUERA SILICÓN-MOTOR A TUBO	SIH250363C
BANDA-ALT	9447
TERMOSTATO-190°	33579
TERMOSTATO-180°	33576
TERMOSTATO-180°	33578
TERMOSTATO-170°	33577

2002	
BANDA-VENT	K100465
MANGUERA INFERIOR-TUBO A RAD.	21135
MANGUERA SUPERIOR-TUBO A RAD.	21135
BANDA-TOMA DE FUERZA-AA	9405
MANGUERA SILICÓN-MOTOR A TUBO	SIH250363C
BANDA-BA	K060415
BANDA-ALT	2/9447PB

2001	
BANDA-VENT	K100465
MANGUERA INFERIOR-TUBO A RAD.	21135
MANGUERA SUPERIOR-TUBO A RAD.	21135
BANDA-TOMA DE FUERZA-AA	9405
MANGUERA SILICÓN-MOTOR A TUBO	SIH250363C

2001	
BANDA-VENT	K100465
MANGUERA INFERIOR-TUBO A RAD.	21135
MANGUERA SUPERIOR-TUBO A RAD.	21135
BANDA-TOMA DE FUERZA-AA	9405
MANGUERA SILICÓN-MOTOR A TUBO	SIH250363C
BANDA-BA	K060415
BANDA-ALT	2/9447PB
BANDA-ALT	9447
TERMOSTATO-190°	33579
TERMOSTATO-180°	33576
TERMOSTATO-180°	33578
TERMOSTATO-170°	33577

2000	
BANDA-VENT	K100465
MANGUERA INFERIOR-TUBO A RAD.	21135



MASTER SERVICIO PESADO 2014

INTERNATIONAL/
NAVISTAR
9400I

MANGUERA SUPERIOR-TUBO A RAD.	21135	MANGUERA SUPERIOR-MOTOR A TUBO	21135
BANDA-TOMA DE FUERZA-AA	9405	BANDA-ALT-VENT	K120911
MANGUERA SILICÓN-MOTOR A TUBO	SIH250363C	POLEA-ALT-VENT	36165
BANDA-BA	K060415	TENSOR-ALT-VENT	38587
BANDA-ALT	29447PB	2004	
BANDA-ALT	9447	MANGUERA INFERIOR-TUBO A RAD.	21891
TERMOSTATO-190°	33579	POLEA-TOMA DE FUERZA-AA	36223
TERMOSTATO-180°	33576	TENSOR-TOMA DE FUERZA-AA	38610
TERMOSTATO-180°	33578	MANGUERA SUPERIOR-RAD. A TUBO	21135
TERMOSTATO-170°	33577	MANGUERA INFERIOR-MOTOR A TUBO	21891
CUMMINS ISX DIESEL		MANGUERA SILICÓN-MOTOR A TUBO	SIH250363C
2007		MANGUERA SUPERIOR-MOTOR A TUBO	21135
BANDA-TOMA DE FUERZA-AA	K060637	BANDA-ALT-VENT	K120911
POLEA-TOMA DE FUERZA-AA	36223	POLEA-ALT-VENT	36165
TENSOR-TOMA DE FUERZA-AA	38610	TENSOR-ALT-VENT	38587
MANGUERA INFERIOR-RAD. A TUBO	21891	BANDA-AA	K060637
MANGUERA SUPERIOR-RAD. A TUBO	21135	2003	
MANGUERA INFERIOR-MOTOR A TUBO	21891	MANGUERA INFERIOR-TUBO A RAD.	21891
MANGUERA SILICÓN-MOTOR A TUBO	SIH250363C	MANGUERA SUPERIOR-RAD. A TUBO	21135
MANGUERA SUPERIOR-MOTOR A TUBO	21135	MANGUERA SILICÓN-MOTOR A TUBO	SIH250363C
BANDA-ALT-VENT	K120911	MANGUERA SUPERIOR-MOTOR A TUBO	21135
POLEA-ALT-VENT	36165	BANDA-ALT-VENT	K120979
TENSOR-ALT-VENT	38587	TENSOR-ALT-VENT	38587
2006		BANDA-AA	K060637
BANDA-TOMA DE FUERZA-AA	K060637	2002	
POLEA-TOMA DE FUERZA-AA	36223	BANDA-VENT	K100719
TENSOR-TOMA DE FUERZA-AA	38610	POLEA DEL TENSOR-VENT	36092
MANGUERA INFERIOR-RAD. A TUBO	21891	TENSOR-VENT	38535
MANGUERA SUPERIOR-RAD. A TUBO	21135	MANGUERA INFERIOR-TUBO A RAD.	21135
MANGUERA INFERIOR-MOTOR A TUBO	21891	MANGUERA SUPERIOR-TUBO A RAD.	21891
MANGUERA SILICÓN-MOTOR A TUBO	SIH250363C	BANDA-TOMA DE FUERZA-ALT-AA	K060685
MANGUERA SUPERIOR-MOTOR A TUBO	21135	POLEA DEL TENSOR-TOMA DE FUERZA-ALT-AA	36095
BANDA-ALT-VENT	K120911	TENSOR-TOMA DE FUERZA-ALT-AA	38532
POLEA-ALT-VENT	36165	MANGUERA INFERIOR-MOTOR A TUBO	21891
TENSOR-ALT-VENT	38587	MANGUERA SUPERIOR-MOTOR A TUBO	21135
2005		2001	
BANDA-TOMA DE FUERZA-AA	K060637	BANDA-VENT	K100719
POLEA-TOMA DE FUERZA-AA	36223	POLEA DEL TENSOR-VENT	36092
TENSOR-TOMA DE FUERZA-AA	38610	TENSOR-VENT	38535
MANGUERA INFERIOR-RAD. A TUBO	21891	MANGUERA INFERIOR-TUBO A RAD.	21135
MANGUERA SUPERIOR-RAD. A TUBO	21135	MANGUERA SUPERIOR-TUBO A RAD.	21891
MANGUERA INFERIOR-MOTOR A TUBO	21891	BANDA-TOMA DE FUERZA-ALT-AA	K060685
MANGUERA SILICÓN-MOTOR A TUBO	SIH250363C	POLEA DEL TENSOR-TOMA DE FUERZA-ALT-AA	36095



MASTER SERVICIO PESADO 2014

INTERNATIONAL/
NAVISTAR
9400I

TENSOR-TOMA DE FUERZA-ALT-AA	38532	MANGUERA SUPERIOR-RAD. A TUBO	21135
MANGUERA INFERIOR-MOTOR A TUBO	21891	MANGUERA SILICÓN-MOTOR A TUBO	SIH250363C
MANGUERA SUPERIOR-MOTOR A TUBO	21135	BANDA-ALT-VENT	K080740
2000		POLEA-ALT-VENT	36308
BANDA-VENT	K100719	TENSOR-ALT-VENT	38521
POLEA DEL TENSOR-VENT	36092	POLEA DEL TENSOR-	36091
TENSOR-VENT	38535	2004	
MANGUERA INFERIOR-TUBO A RAD.	21135	BANDA-TOMA DE FUERZA-AA	K060516
MANGUERA SUPERIOR-TUBO A RAD.	21891	POLEA-TOMA DE FUERZA-AA	36225
BANDA-TOMA DE FUERZA-ALT-AA	K060685	TENSOR-TOMA DE FUERZA-AA	38505
POLEA DEL TENSOR-TOMA DE FUERZA-ALT-AA	36095	MANGUERA INFERIOR-RAD. A TUBO	21891
TENSOR-TOMA DE FUERZA-ALT-AA	38532	MANGUERA SUPERIOR-RAD. A TUBO	21135
MANGUERA INFERIOR-MOTOR A TUBO	21891	MANGUERA SILICÓN-MOTOR A TUBO	SIH250363C
MANGUERA SUPERIOR-MOTOR A TUBO	21135	BANDA-ALT-VENT	K080740
CUMMINS ISM DIESEL		POLEA-ALT-VENT	36308
2007		TENSOR-ALT-VENT	38521
BANDA-TOMA DE FUERZA-AA	K060516	POLEA DEL TENSOR-	36091
POLEA-TOMA DE FUERZA-AA	36225	2003	
TENSOR-TOMA DE FUERZA-AA	38505	BANDA-VENT	K080565
MANGUERA INFERIOR-RAD. A TUBO	21135	MANGUERA INFERIOR-TUBO A RAD.	CHARTER 2 1/2"
MANGUERA SILICÓN-RAD. A TUBO	SIH250363C	MANGUERA SUPERIOR-TUBO A RAD.	21135
MANGUERA INFERIOR-MOTOR A TUBO	21891	BANDA-TOMA DE FUERZA-ALT	K050336
MANGUERA SILICÓN-MOTOR A TUBO	SIH250363C	BANDA-TOMA DE FUERZA-AA	TR22485
BANDA-ALT-VENT	K080740	MANGUERA INFERIOR-MOTOR A TUBO	21135
POLEA-ALT-VENT	36308	MANGUERA SUPERIOR-MOTOR A TUBO	CHARTER 2 1/2"
TENSOR-ALT-VENT	38622	2002	
POLEA DEL TENSOR-	36091	BANDA-VENT	K080565
2006		MANGUERA INFERIOR-TUBO A RAD.	CHARTER 2 1/2"
BANDA-TOMA DE FUERZA-AA	K060516	MANGUERA SUPERIOR-TUBO A RAD.	21135
POLEA-TOMA DE FUERZA-AA	36225	BANDA-TOMA DE FUERZA-ALT	K050336
TENSOR-TOMA DE FUERZA-AA	38505	BANDA-TOMA DE FUERZA-AA	TR22485
MANGUERA INFERIOR-RAD. A TUBO	21891	MANGUERA INFERIOR-MOTOR A TUBO	21135
MANGUERA SUPERIOR-RAD. A TUBO	21135	MANGUERA SUPERIOR-MOTOR A TUBO	CHARTER 2 1/2"
MANGUERA SILICÓN-MOTOR A TUBO	SIH250363C	2001	
BANDA-ALT-VENT	K080740	BANDA-VENT	K080565
POLEA-ALT-VENT	36308	MANGUERA INFERIOR-TUBO A RAD.	CHARTER 2 1/2"
TENSOR-ALT-VENT	38622	MANGUERA SUPERIOR-TUBO A RAD.	21135
POLEA DEL TENSOR-	36091	BANDA-TOMA DE FUERZA-ALT	K050336
2005		BANDA-TOMA DE FUERZA-AA	TR22485
BANDA-TOMA DE FUERZA-AA	K060516	MANGUERA INFERIOR-MOTOR A TUBO	21135
POLEA-TOMA DE FUERZA-AA	36225	MANGUERA SUPERIOR-MOTOR A TUBO	CHARTER 2 1/2"
TENSOR-TOMA DE FUERZA-AA	38505	2000	
MANGUERA INFERIOR-RAD. A TUBO	21891	BANDA-VENT	K080565



MASTER SERVICIO PESADO 2014

INTERNATIONAL/
NAVISTAR
9400I

MANGUERA SILICÓN-TUBO A RAD.	SIH250363C	BANDA-ALT-VENT	K100771
MANGUERA SUPERIOR-TUBO A RAD.	21135	TERMOSTATO-190°	33579
BANDA-TOMA DE FUERZA-ALT	K050336	TERMOSTATO-180°	33576
BANDA-TOMA DE FUERZA-AA	TR22485	TERMOSTATO-180°	33578
MANGUERA INFERIOR-MOTOR A TUBO	21135	TERMOSTATO-170°	33577
MANGUERA SILICÓN-MOTOR A TUBO	SIH250363C	CATERPILLAR C15 DIESEL	
CATERPILLAR C16 DIESEL		2007	
2003		BANDA-VENT-AA	K060605
BANDA-VENT-AA	K060500	POLEA DEL TENSOR-VENT-AA	36091
MANGUERA INFERIOR-TUBO A RAD.	21135	TENSOR-VENT-AA	38511
MANGUERA SUPERIOR-TUBO A RAD.	21135	MANGUERA SILICÓN-RAD. A TUBO	SIH250363C
MANGUERA SILICÓN-MOTOR A TUBO	SIH250363C	MANGUERA SUPERIOR-RAD. A TUBO	21135
BANDA-ALT-VENT	K100771	MANGUERA SILICÓN-MOTOR A TUBO	SIH300363C
TERMOSTATO-190°	33579	MANGUERA SUPERIOR-MOTOR A TUBO	21891
TERMOSTATO-180°	33576	POLEA-MOTOR	36341
TERMOSTATO-180°	33578	BANDA-ALT-VENT	K080991
TERMOSTATO-170°	33577	TENSOR-ALT-VENT	38569
2002		TERMOSTATO-190°	33579
BANDA-VENT-AA	K060500	TERMOSTATO-180°	33576
MANGUERA INFERIOR-TUBO A RAD.	21135	TERMOSTATO-180°	33578
MANGUERA SUPERIOR-TUBO A RAD.	21135	TERMOSTATO-170°	33577
MANGUERA SILICÓN-MOTOR A TUBO	SIH250363C	TAPÓN DE RADIADOR-(10 LBS) SIN PALANCA	31567
BANDA-ALT-VENT	K100771	BOMBA DE AGUA-	44062HD
TERMOSTATO-190°	33579	POLEA DEL TENSOR-	36091
TERMOSTATO-180°	33576	2006	
TERMOSTATO-180°	33578	BANDA-VENT-AA	K060605
TERMOSTATO-170°	33577	POLEA DEL TENSOR-VENT-AA	36091
2001		TENSOR-VENT-AA	38511
BANDA-VENT-AA	K060500	MANGUERA SILICÓN-RAD. A TUBO	SIH250363C
MANGUERA INFERIOR-TUBO A RAD.	CHARTER 2 1/2"	MANGUERA SUPERIOR-RAD. A TUBO	21135
MANGUERA SUPERIOR-TUBO A RAD.	CHARTER 2 1/2"	MANGUERA SILICÓN-MOTOR A TUBO	SIH300363C
MANGUERA INFERIOR-MOTOR A TUBO	21135	MANGUERA SUPERIOR-MOTOR A TUBO	21891
MANGUERA SUPERIOR-MOTOR A TUBO	21135	POLEA-MOTOR	36091
BANDA-ALT-VENT	K100771	POLEA-MOTOR	36093
TERMOSTATO-190°	33579	BANDA-ALT-VENT	K080991
TERMOSTATO-180°	33576	TENSOR-ALT-VENT	38569
TERMOSTATO-180°	33578	TERMOSTATO-190°	33579
TERMOSTATO-170°	33577	TERMOSTATO-180°	33576
2000		TERMOSTATO-180°	33578
BANDA-VENT-AA	K060500	TERMOSTATO-170°	33577
MANGUERA SILICÓN-TUBO A RAD.	SIH250363C	BOMBA DE AGUA-	44062HD
MANGUERA INFERIOR-MOTOR A TUBO	21135	2005	
MANGUERA SUPERIOR-MOTOR A TUBO	21135	BANDA-VENT-AA	K060605



MASTER SERVICIO PESADO 2014

INTERNATIONAL/
NAVISTAR
9400I

POLEA DEL TENSOR-VENT-AA	36091	TERMOSTATO-180°	33576
TENSOR-VENT-AA	38511	TERMOSTATO-180°	33578
MANGUERA SILICÓN-RAD. A TUBO	SIH250363C	TERMOSTATO-170°	33577
MANGUERA SUPERIOR-RAD. A TUBO	21135	2001	
MANGUERA SILICÓN-MOTOR A TUBO	SIH300363C	BANDA-VENT-AA	K060500
MANGUERA SUPERIOR-MOTOR A TUBO	21891	MANGUERA INFERIOR-TUBO A RAD.	CHARTER 2 1/2"
POLEA-MOTOR	36091	MANGUERA SUPERIOR-TUBO A RAD.	CHARTER 2 1/2"
POLEA-MOTOR	36093	MANGUERA INFERIOR-MOTOR A TUBO	21135
BANDA-ALT-VENT	K080991	MANGUERA SUPERIOR-MOTOR A TUBO	21135
TENSOR-ALT-VENT	38569	BANDA-ALT-VENT	K100771
TERMOSTATO-190°	33579	TERMOSTATO-190°	33579
TERMOSTATO-180°	33576	TERMOSTATO-180°	33576
TERMOSTATO-180°	33578	TERMOSTATO-180°	33578
TERMOSTATO-170°	33577	TERMOSTATO-170°	33577
2004		2000	
BANDA-VENT-AA	K060605	BANDA-VENT-AA	K060500
POLEA DEL TENSOR-VENT-AA	36091	MANGUERA SILICÓN-TUBO A RAD.	SIH250363C
TENSOR-VENT-AA	38511	MANGUERA INFERIOR-MOTOR A TUBO	21135
POLEA-MOTOR	36091	MANGUERA SUPERIOR-MOTOR A TUBO	21135
POLEA-MOTOR	36093	BANDA-ALT-VENT	K100771
BANDA-ALT-VENT	K080991	TERMOSTATO-190°	33579
TENSOR-ALT-VENT	38569	TERMOSTATO-180°	33576
TERMOSTATO-190°	33579	TERMOSTATO-180°	33578
TERMOSTATO-180°	33576	TERMOSTATO-170°	33577
TERMOSTATO-180°	33578	CATERPILLAR C13 DIESEL	
TERMOSTATO-170°	33577	2007	
2003		POLEA-MOTOR	36269
BANDA-VENT-AA	K060500	POLEA-MOTOR	36341
MANGUERA INFERIOR-TUBO A RAD.	21135	BANDA-ALT-VENT-AA	K081000
MANGUERA SUPERIOR-TUBO A RAD.	21135	TENSOR-ALT-VENT-AA	38590
MANGUERA SILICÓN-MOTOR A TUBO	SIH250363C	TERMOSTATO-190°	33579
BANDA-ALT-VENT	K100771	TERMOSTATO-180°	33576
TERMOSTATO-190°	33579	TERMOSTATO-180°	33578
TERMOSTATO-180°	33576	TERMOSTATO-170°	33577
TERMOSTATO-180°	33578	POLEA DEL TENSOR-	36164
TERMOSTATO-170°	33577	2006	
2002		POLEA-MOTOR	36269
BANDA-VENT-AA	K060500	POLEA-MOTOR	36341
MANGUERA INFERIOR-TUBO A RAD.	21135	BANDA-ALT-VENT-AA	K081000
MANGUERA SUPERIOR-TUBO A RAD.	21135	TENSOR-ALT-VENT-AA	38590
MANGUERA SILICÓN-MOTOR A TUBO	SIH250363C	TERMOSTATO-190°	33579
BANDA-ALT-VENT	K100771	TERMOSTATO-180°	33576
TERMOSTATO-190°	33579	TERMOSTATO-180°	33578



TERMOSTATO-170°	33577	MANGUERA SILICÓN-TUBO A RAD.	SIH250363C
POLEA DEL TENSOR-	36164	MANGUERA INFERIOR-RAD. A TUBO	21135
2005		MANGUERA INFERIOR-MOTOR A TUBO	21891
POLEA-MOTOR	36269	MANGUERA SUPERIOR-MOTOR A TUBO	21135
POLEA-MOTOR	36341	BANDA-ALT-VENT	K080733
BANDA-ALT-VENT-AA	K081000	TERMOSTATO-190°	33579
TENSOR-ALT-VENT-AA	38590	TERMOSTATO-180°	33576
TERMOSTATO-190°	33579	TERMOSTATO-180°	33578
TERMOSTATO-180°	33576	TERMOSTATO-170°	33577
TERMOSTATO-180°	33578	2001	
TERMOSTATO-170°	33577	BANDA-VENT-AA	2/9463PB
POLEA DEL TENSOR-	36164	BANDA-VENT-AA	9463
2004		MANGUERA SILICÓN-TUBO A RAD.	SIH250363C
POLEA-MOTOR	36269	MANGUERA INFERIOR-RAD. A TUBO	21135
POLEA-MOTOR	36341	MANGUERA INFERIOR-MOTOR A TUBO	21891
BANDA-ALT-VENT-AA	K081000	MANGUERA SUPERIOR-MOTOR A TUBO	21135
TENSOR-ALT-VENT-AA	38590	BANDA-ALT-VENT	K080733
TERMOSTATO-190°	33579	TERMOSTATO-190°	33579
TERMOSTATO-180°	33576	TERMOSTATO-180°	33576
TERMOSTATO-180°	33578	TERMOSTATO-180°	33578
TERMOSTATO-170°	33577	TERMOSTATO-170°	33577
POLEA DEL TENSOR-	36164	2000	
CATERPILLAR C12 DIESEL		BANDA-VENT-AA	2/9463PB
2004		BANDA-VENT-AA	9463
TERMOSTATO-190°	33579	MANGUERA SILICÓN-TUBO A RAD.	SIH250363C
TERMOSTATO-180°	33576	MANGUERA INFERIOR-RAD. A TUBO	21135
TERMOSTATO-180°	33578	MANGUERA INFERIOR-MOTOR A TUBO	21891
TERMOSTATO-170°	33577	MANGUERA SUPERIOR-MOTOR A TUBO	21135
2003		BANDA-ALT-VENT	K080733
BANDA-VENT-AA	2/9463PB	TERMOSTATO-190°	33579
BANDA-VENT-AA	9463	TERMOSTATO-180°	33576
MANGUERA SILICÓN-TUBO A RAD.	SIH250363C	TERMOSTATO-180°	33578
MANGUERA INFERIOR-RAD. A TUBO	21135	TERMOSTATO-170°	33577
MANGUERA INFERIOR-MOTOR A TUBO	21891	CATERPILLAR C10 DIESEL	
MANGUERA SUPERIOR-MOTOR A TUBO	21135	2002	
BANDA-ALT-VENT	K080733	BANDA-VENT-AA	2/9463PB
TERMOSTATO-190°	33579	BANDA-VENT-AA	9463
TERMOSTATO-180°	33576	MANGUERA SILICÓN-TUBO A RAD.	SIH250363C
TERMOSTATO-180°	33578	MANGUERA INFERIOR-RAD. A TUBO	21135
TERMOSTATO-170°	33577	MANGUERA INFERIOR-MOTOR A TUBO	21891
2002		MANGUERA SUPERIOR-MOTOR A TUBO	21135
BANDA-VENT-AA	2/9463PB	BANDA-ALT-VENT	K080733
BANDA-VENT-AA	9463	TERMOSTATO-190°	33579



MASTER SERVICIO PESADO 2014

INTERNATIONAL/
NAVISTAR
94001

TERMOSTATO-180°	33576	2000	
TERMOSTATO-180°	33578	BANDA-VENT-AA	K060500
TERMOSTATO-170°	33577	MANGUERA SILICÓN-TUBO A RAD.	SIH250363C
2001		MANGUERA SUPERIOR-TUBO A RAD.	21135
BANDA-VENT-AA	2/9463PB	MANGUERA INFERIOR-MOTOR A TUBO	CHARTER 3"
BANDA-VENT-AA	9463	MANGUERA SILICÓN-MOTOR A TUBO	SIH250363C
MANGUERA SILICÓN-TUBO A RAD.	SIH250363C	BANDA-ALT-VENT	K100771
MANGUERA INFERIOR-RAD. A TUBO	21135	TERMOSTATO-190°	33579
MANGUERA INFERIOR-MOTOR A TUBO	21891	TERMOSTATO-180°	33576
MANGUERA SUPERIOR-MOTOR A TUBO	21135	TERMOSTATO-180°	33578
BANDA-ALT-VENT	K080733	TERMOSTATO-170°	33577
TERMOSTATO-190°	33579	9600	
TERMOSTATO-180°	33576	DETROIT DIESEL 6 CIL, 12.7 L DIESEL	
TERMOSTATO-180°	33578	1996	
TERMOSTATO-170°	33577	TERMOSTATO-190°	33599
2000		1995	
BANDA-VENT-AA	2/9463PB	BANDA-VENT	K100540
BANDA-VENT-AA	9463	BANDA-VENT	K100607
MANGUERA SILICÓN-TUBO A RAD.	SIH250363C	POLEA DEL TENSOR-VENT	36092
MANGUERA INFERIOR-RAD. A TUBO	21135	TENSOR-VENT	38519
MANGUERA INFERIOR-MOTOR A TUBO	21891	MANGUERA SILICÓN-TUBO A RAD.	SIH250363C
MANGUERA SUPERIOR-MOTOR A TUBO	21135	MANGUERA SILICÓN-MOTOR A TUBO	SIH250363C
BANDA-ALT-VENT	K080733	BANDA-ALT	2/9313PB
TERMOSTATO-190°	33579	BANDA-ALT	9313
TERMOSTATO-180°	33576	BANDA-ALT	K060455
TERMOSTATO-180°	33578	BANDA-AA	K060470
TERMOSTATO-170°	33577	TERMOSTATO-190°	33599
CATERPILLAR 3406 DIESEL		DETROIT DIESEL 6 CIL, 11.1 L DIESEL	
2003		1996	
TERMOSTATO-190°	33579	BANDA-VENT	K100540
TERMOSTATO-180°	33576	BANDA-VENT	K100607
TERMOSTATO-180°	33578	POLEA DEL TENSOR-VENT	36092
TERMOSTATO-170°	33577	TENSOR-VENT	38519
2002		MANGUERA SILICÓN-TUBO A RAD.	SIH250363C
TERMOSTATO-190°	33579	MANGUERA SILICÓN-MOTOR A TUBO	SIH250363C
TERMOSTATO-180°	33576	BANDA-ALT	2/9313PB
TERMOSTATO-180°	33578	BANDA-ALT	9313
TERMOSTATO-170°	33577	BANDA-ALT	K060455
2001		BANDA-AA	K060470
TERMOSTATO-190°	33579	TERMOSTATO-190°	33599
TERMOSTATO-180°	33576	1995	
TERMOSTATO-180°	33578	TERMOSTATO-190°	33599
TERMOSTATO-170°	33577	CUMMINS N14 DIESEL	



1996		TERMOSTATO-180°	33576
BANDA-VENT-C/VENT CLUTCH EVANS, HORTON, ROCKFORD	TR28514	TERMOSTATO-180°	33578
BANDA-VENT- OPCIONAL	TR28492	TERMOSTATO-170°	33577
BANDA-VENT	2/TR28492PB	1995	
BANDA-VENT	TR28498	TERMOSTATO-190°	33579
MANGUERA SILICÓN-TUBO A RAD.	SIH250363C	TERMOSTATO-180°	33576
MANGUERA SILICÓN-MOTOR A TUBO	SIH250363C	TERMOSTATO-180°	33578
BANDA-C/DOBLE COMP	2/9470PB	TERMOSTATO-170°	33577
BANDA-C/DOBLE COMP	9470	CATERPILLAR 3176 DIESEL	
BANDA-BA	K040425	1996	
BANDA-BA	K060425	TERMOSTATO-190°	33579
BANDA-BA	K060435	TERMOSTATO-180°	33576
BANDA-ALT	9420	TERMOSTATO-180°	33578
TERMOSTATO-190°	33579	TERMOSTATO-170°	33577
TERMOSTATO-180°	33576	1995	
TERMOSTATO-180°	33578	TERMOSTATO-190°	33579
TERMOSTATO-170°	33577	TERMOSTATO-180°	33576
BANDA-	9420	TERMOSTATO-180°	33578
BANDA-	9430	TERMOSTATO-170°	33577
1995		9700	
TERMOSTATO-190°	33579	DETROIT DIESEL 6 CIL, 12.7 L DIESEL	
TERMOSTATO-180°	33576	1996	
TERMOSTATO-180°	33578	BANDA-VENT	K100540
TERMOSTATO-170°	33577	BANDA-VENT	K100607
CUMMINS M11 DIESEL		POLEA DEL TENSOR-VENT	36092
1996		TENSOR-VENT	38519
BANDA-VENT	K080565	MANGUERA SILICÓN-TUBO A RAD.	SIH250363C
MANGUERA SILICÓN-TUBO A RAD.	SIH250363C	MANGUERA SILICÓN-MOTOR A TUBO	SIH250363C
MANGUERA SILICÓN-MOTOR A TUBO	SIH250363C	BANDA-ALT	2/9313PB
BANDA-ALT-BA	K050415	BANDA-ALT	9313
TERMOSTATO-190°	33579	BANDA-ALT	K060455
TERMOSTATO-180°	33576	BANDA-AA	K060470
TERMOSTATO-180°	33578	TERMOSTATO-190°	33599
TERMOSTATO-170°	33577	1995	
BANDA-	TR22570	TERMOSTATO-190°	33599
1995		DETROIT DIESEL 6 CIL, 11.1 L DIESEL	
TERMOSTATO-190°	33579	1996	
TERMOSTATO-180°	33576	BANDA-VENT	K100540
TERMOSTATO-180°	33578	BANDA-VENT	K100607
TERMOSTATO-170°	33577	POLEA DEL TENSOR-VENT	36092
CATERPILLAR 3406 DIESEL		TENSOR-VENT	38519
1996		MANGUERA SILICÓN-TUBO A RAD.	SIH250363C
TERMOSTATO-190°	33579	MANGUERA SILICÓN-MOTOR A TUBO	SIH250363C



BANDA-ALT	2/9313PB	1995	
BANDA-ALT	9313	TERMOSTATO-190°	33579
BANDA-ALT	K060455	TERMOSTATO-180°	33576
BANDA-AA	K060470	TERMOSTATO-180°	33578
TERMOSTATO-190°	33599	TERMOSTATO-170°	33577
1995		CATERPILLAR 3406 DIESEL	
TERMOSTATO-190°	33599	1996	
CUMMINS N14 DIESEL		TERMOSTATO-190°	33579
1996		TERMOSTATO-180°	33576
BANDA-VENT-C/VENT CLUTCH EVANS, HORTON, ROCKFORD	TR28514	TERMOSTATO-180°	33578
BANDA-VENT- OPCIONAL	TR28492	TERMOSTATO-170°	33577
BANDA-VENT	2/TR28492PB	1995	
BANDA-VENT	TR28498	TERMOSTATO-190°	33579
MANGUERA SILICÓN-TUBO A RAD.	SIH250363C	TERMOSTATO-180°	33576
MANGUERA SILICÓN-MOTOR A TUBO	SIH250363C	TERMOSTATO-180°	33578
BANDA-C/DOBLE COMP	2/9470PB	TERMOSTATO-170°	33577
BANDA-C/DOBLE COMP	9470	CATERPILLAR 3176 DIESEL	
BANDA-BA	K040425	1995	
BANDA-BA	K060425	TERMOSTATO-190°	33579
BANDA-BA	K060435	TERMOSTATO-180°	33576
BANDA-ALT	9420	TERMOSTATO-180°	33578
TERMOSTATO-190°	33579	TERMOSTATO-170°	33577
TERMOSTATO-180°	33576	9800	
TERMOSTATO-180°	33578	DETROIT DIESEL SERIE 60	
TERMOSTATO-170°	33577	1999	
BANDA-	9420	TERMOSTATO-190°	33599
BANDA-	9430	1998	
1995		TERMOSTATO-190°	33599
TERMOSTATO-190°	33579	1997	
TERMOSTATO-180°	33576	BANDA-VENT	K100540
TERMOSTATO-180°	33578	BANDA-VENT	K100607
TERMOSTATO-170°	33577	POLEA DEL TENSOR-VENT	36092
CUMMINS M11 DIESEL		TENSOR-VENT	38519
1996		MANGUERA SILICÓN-TUBO A RAD.	SIH250363C
BANDA-VENT	K080565	MANGUERA SILICÓN-MOTOR A TUBO	SIH250363C
MANGUERA SILICÓN-TUBO A RAD.	SIH250363C	BANDA-ALT	2/9313PB
MANGUERA SILICÓN-MOTOR A TUBO	SIH250363C	BANDA-ALT	9313
BANDA-ALT-BA	K050415	BANDA-ALT	K060455
TERMOSTATO-190°	33579	BANDA-AA	K060470
TERMOSTATO-180°	33576	TERMOSTATO-190°	33599
TERMOSTATO-180°	33578	DETROIT DIESEL 6 CIL, 12.7 L DIESEL	
TERMOSTATO-170°	33577	1996	
BANDA-	TR22570	TERMOSTATO-190°	33599
		DETROIT DIESEL 6 CIL, 11.1 L DIESEL	



1996		TERMOSTATO-190°	33579
TERMOSTATO-190°	33599	TERMOSTATO-180°	33576
CUMMINS N14 DIESEL			
1999		TERMOSTATO-180°	33578
BANDA-VENT- OPCIONAL	TR28492	TERMOSTATO-170°	33577
BANDA-VENT	2/TR28492PB	BANDA-	9405
BANDA-VENT	TR28514	1996	
BANDA-VENT	TR28550	TERMOSTATO-190°	33579
BANDA-VENT	TR28565	TERMOSTATO-180°	33576
MANGUERA SILICÓN-TUBO A RAD.	SIH250363C	TERMOSTATO-180°	33578
MANGUERA SILICÓN-MOTOR A TUBO	SIH250363C	TERMOSTATO-170°	33577
BANDA-BA	K060425	CUMMINS M11 DIESEL	
BANDA-BA	K060435	1999	
TERMOSTATO-190°	33579	TERMOSTATO-190°	33579
TERMOSTATO-180°	33576	TERMOSTATO-180°	33576
TERMOSTATO-180°	33578	TERMOSTATO-180°	33578
TERMOSTATO-170°	33577	TERMOSTATO-170°	33577
BANDA-	9405	1998	
1998		TERMOSTATO-190°	33579
BANDA-VENT- OPCIONAL	TR28492	TERMOSTATO-180°	33576
BANDA-VENT	2/TR28492PB	TERMOSTATO-180°	33578
BANDA-VENT	TR28514	TERMOSTATO-170°	33577
BANDA-VENT	TR28550	1997	
BANDA-VENT	TR28565	BANDA-VENT	K080565
MANGUERA SILICÓN-TUBO A RAD.	SIH250363C	MANGUERA SILICÓN-TUBO A RAD.	SIH250363C
MANGUERA SILICÓN-MOTOR A TUBO	SIH250363C	MANGUERA SILICÓN-MOTOR A TUBO	SIH250363C
BANDA-BA	K060425	BANDA-ALT-BA	K050415
BANDA-BA	K060435	TERMOSTATO-190°	33579
TERMOSTATO-190°	33579	TERMOSTATO-180°	33576
TERMOSTATO-180°	33576	TERMOSTATO-180°	33578
TERMOSTATO-180°	33578	TERMOSTATO-170°	33577
TERMOSTATO-170°	33577	BANDA-	TR22570
BANDA-	9405	1996	
1997		TERMOSTATO-190°	33579
BANDA-VENT- OPCIONAL	TR28492	TERMOSTATO-180°	33576
BANDA-VENT	2/TR28492PB	TERMOSTATO-180°	33578
BANDA-VENT	TR28514	TERMOSTATO-170°	33577
BANDA-VENT	TR28550	9900	
BANDA-VENT	TR28565	DETROIT DIESEL SERIE 60	
MANGUERA SILICÓN-TUBO A RAD.	SIH250363C	1999	
MANGUERA SILICÓN-MOTOR A TUBO	SIH250363C	BANDA-VENT	K100540
BANDA-BA	K060425	POLEA DEL TENSOR-VENT	36092
BANDA-BA	K060435	TENSOR-VENT	38519
		MANGUERA INFERIOR-TUBO A RAD.	21135



MANGUERA SUPERIOR-TUBO A RAD.	21135	MANGUERA SILICÓN-TUBO A RAD.	SIH250363C
MANGUERA SILICÓN-MOTOR A TUBO	SIH250363C	MANGUERA INFERIOR-RAD. A TUBO	21135
MANGUERA SUPERIOR-MOTOR A TUBO	21891	MANGUERA INFERIOR-MOTOR A TUBO	21891
BANDA-ALT	K060455	MANGUERA SUPERIOR-MOTOR A TUBO	21135
BANDA-AA	K060340	BANDA-ALT-VENT	K080733
TERMOSTATO-190°	33599	TERMOSTATO-190°	33579
CUMMINS N14 DIESEL		TERMOSTATO-180°	33576
1999		TERMOSTATO-180°	33578
BANDA-VENT	K100465	TERMOSTATO-170°	33577
MANGUERA INFERIOR-TUBO A RAD.	21135	CATERPILLAR C10 DIESEL	
MANGUERA SUPERIOR-TUBO A RAD.	21135	1999	
BANDA-TOMA DE FUERZA-AA	9405	BANDA-VENT-AA	2/9463PB
MANGUERA SILICÓN-MOTOR A TUBO	SIH250363C	BANDA-VENT-AA	9463
BANDA-BA	K060415	MANGUERA SILICÓN-TUBO A RAD.	SIH250363C
BANDA-ALT	2/9447PB	MANGUERA INFERIOR-RAD. A TUBO	21135
BANDA-ALT	9447	MANGUERA INFERIOR-MOTOR A TUBO	21891
TERMOSTATO-190°	33579	MANGUERA SUPERIOR-MOTOR A TUBO	21135
TERMOSTATO-180°	33576	BANDA-ALT-VENT	K080733
TERMOSTATO-180°	33578	TERMOSTATO-190°	33579
TERMOSTATO-170°	33577	TERMOSTATO-180°	33576
CUMMINS ISX DIESEL		TERMOSTATO-180°	33578
2005		TERMOSTATO-170°	33577
BANDA-VENT-AA	K060637	CATERPILLAR 3406 DIESEL	
MANGUERA SUPERIOR-RAD. A TUBO	21135	1999	
MANGUERA SUPERIOR-MOTOR A TUBO	21135	BANDA-VENT-AA	K060500
BANDA-ALT-VENT	K120979	MANGUERA SILICÓN-TUBO A RAD.	SIH250363C
MANGUERA INFERIOR-	CHARTER 2 1/2"	MANGUERA SUPERIOR-TUBO A RAD.	21135
CUMMINS ISM DIESEL		MANGUERA INFERIOR-MOTOR A TUBO	CHARTER 3"
1999		MANGUERA SILICÓN-MOTOR A TUBO	SIH250363C
BANDA-VENT	K080465	BANDA-ALT-VENT	K100771
BANDA-ALT	K050336	TERMOSTATO-190°	33579
CATERPILLAR C15 DIESEL		TERMOSTATO-180°	33576
2005		TERMOSTATO-180°	33578
BANDA-VENT-AA	K060557	TERMOSTATO-170°	33577
MANGUERA SUPERIOR-RAD. A TUBO	21135	99001	
MANGUERA SUPERIOR-MOTOR A TUBO	21891	DETROIT DIESEL SERIE 60	
BANDA-ALT-VENT	K081092	2000	
MANGUERA INFERIOR-	CHARTER 2 1/2"	BANDA-VENT	K100540
MANGUERA INFERIOR-	CHARTER 3"	POLEA DEL TENSOR-VENT	36092
CATERPILLAR C12 DIESEL		TENSOR-VENT	38519
1999		MANGUERA INFERIOR-TUBO A RAD.	21135
BANDA-VENT-AA	2/9463PB	MANGUERA SUPERIOR-TUBO A RAD.	21135
BANDA-VENT-AA	9463	MANGUERA SILICÓN-MOTOR A TUBO	SIH250363C



MANGUERA SUPERIOR-MOTOR A TUBO	21891	MANGUERA INFERIOR-TUBO A RAD.	21135
BANDA-ALT	K060455	MANGUERA SUPERIOR-TUBO A RAD.	21135
BANDA-AA	K060340	BANDA-TOMA DE FUERZA-AA	9405
TERMOSTATO-190°	33599	MANGUERA SILICÓN-MOTOR A TUBO	SIH250363C
DETROIT DIESEL 6 CIL, 12.7 L DIESEL			
2003			
BANDA-VENT	K100540	BANDA-BA	K060415
MANGUERA INFERIOR-RAD. A TUBO	21135	BANDA-ALT	2/9447PB
MANGUERA SUPERIOR-RAD. A TUBO	21135	BANDA-ALT	9447
MANGUERA SILICÓN-MOTOR A TUBO	SIH250363C	TERMOSTATO-190°	33579
TERMOSTATO-190°	33599	TERMOSTATO-180°	33576
2002			
BANDA-VENT	K100540	TERMOSTATO-180°	33578
MANGUERA INFERIOR-RAD. A TUBO	21135	TERMOSTATO-170°	33577
MANGUERA SUPERIOR-RAD. A TUBO	21135	2001	
MANGUERA SILICÓN-MOTOR A TUBO	SIH250363C	BANDA-VENT	K100465
TERMOSTATO-190°	33599	MANGUERA INFERIOR-TUBO A RAD.	21135
2001			
BANDA-VENT	K100540	MANGUERA SUPERIOR-TUBO A RAD.	21135
POLEA DEL TENSOR-VENT	36092	BANDA-TOMA DE FUERZA-AA	9405
TENSOR-VENT	38519	MANGUERA SILICÓN-MOTOR A TUBO	SIH250363C
MANGUERA INFERIOR-TUBO A RAD.	21135	BANDA-BA	K060415
MANGUERA SUPERIOR-TUBO A RAD.	21135	BANDA-ALT	2/9447PB
MANGUERA SILICÓN-MOTOR A TUBO	SIH250363C	BANDA-ALT	9447
MANGUERA SUPERIOR-MOTOR A TUBO	21891	TERMOSTATO-190°	33579
BANDA-ALT	K060455	TERMOSTATO-180°	33576
BANDA-AA	K060340	TERMOSTATO-180°	33578
CUMMINS N14 DIESEL			
2003			
MANGUERA INFERIOR-TUBO A RAD.	21135	TERMOSTATO-170°	33577
MANGUERA SUPERIOR-TUBO A RAD.	21135	2000	
BANDA-TOMA DE FUERZA-VENT	K100465	BANDA-VENT	K100465
BANDA-TOMA DE FUERZA-BA	K060425	MANGUERA INFERIOR-TUBO A RAD.	21135
BANDA-TOMA DE FUERZA-AA	9405	MANGUERA SUPERIOR-TUBO A RAD.	21135
MANGUERA INFERIOR-MOTOR A TUBO	CHARTER 2 1/2"	BANDA-TOMA DE FUERZA-AA	9405
MANGUERA SILICÓN-MOTOR A TUBO	SIH250363C	MANGUERA SILICÓN-MOTOR A TUBO	SIH250363C
BANDA-ALT	9447	BANDA-BA	K060415
TERMOSTATO-190°	33579	BANDA-ALT	2/9447PB
TERMOSTATO-180°	33576	BANDA-ALT	9447
TERMOSTATO-180°	33578	TERMOSTATO-190°	33579
TERMOSTATO-170°	33577	TERMOSTATO-180°	33576
2002			
BANDA-VENT	K100465	TERMOSTATO-180°	33578
CUMMINS ISX DIESEL			
2008			
MANGUERA INFERIOR-TUBO A RAD.	21891	TERMOSTATO-170°	33577
MANGUERA SILICÓN-TUBO A RAD.	SIH250363C	CUMMINS ISX DIESEL	
MANGUERA INFERIOR-RAD. A TUBO	21135	2008	
MANGUERA SUPERIOR-RAD. A TUBO	21135	MANGUERA INFERIOR-TUBO A RAD.	21891
		MANGUERA SILICÓN-TUBO A RAD.	SIH250363C
		MANGUERA INFERIOR-RAD. A TUBO	21135
		MANGUERA SUPERIOR-RAD. A TUBO	21135



MASTER SERVICIO PESADO 2014

INTERNATIONAL/
NAVISTAR
9900I

MANGUERA SILICÓN-MOTOR A TUBO	SIH250363C	BANDA-AA	K060637
MANGUERA SUPERIOR-MOTOR A TUBO	21135	POLEA-AA	36223
BANDA-ALT-VENT	K120979	TENSOR-AA	38610
TENSOR-ALT-VENT	38587	POLEA DEL TENSOR-	36165
BANDA-AA	K060637	2004	
POLEA-AA	36223	MANGUERA INFERIOR-TUBO A RAD.	21891
TENSOR-AA	38610	MANGUERA SILICÓN-TUBO A RAD.	SIH250363C
POLEA DEL TENSOR-	36165	MANGUERA INFERIOR-RAD. A TUBO	21135
2007		MANGUERA SUPERIOR-RAD. A TUBO	21135
MANGUERA INFERIOR-TUBO A RAD.	21891	MANGUERA SILICÓN-MOTOR A TUBO	SIH250363C
MANGUERA SILICÓN-TUBO A RAD.	SIH250363C	MANGUERA SUPERIOR-MOTOR A TUBO	21135
MANGUERA INFERIOR-RAD. A TUBO	21135	BANDA-ALT-VENT	K120979
MANGUERA SUPERIOR-RAD. A TUBO	21135	TENSOR-ALT-VENT	38587
MANGUERA SILICÓN-MOTOR A TUBO	SIH250363C	BANDA-AA	K060637
MANGUERA SUPERIOR-MOTOR A TUBO	21135	POLEA-AA	36223
BANDA-ALT-VENT	K120979	TENSOR-AA	38610
TENSOR-ALT-VENT	38587	POLEA DEL TENSOR-	36165
BANDA-AA	K060637	2003	
POLEA-AA	36223	MANGUERA INFERIOR-TUBO A RAD.	21891
TENSOR-AA	38610	MANGUERA SILICÓN-TUBO A RAD.	SIH250363C
POLEA DEL TENSOR-	36165	MANGUERA INFERIOR-RAD. A TUBO	21135
2006		MANGUERA SUPERIOR-RAD. A TUBO	21135
MANGUERA INFERIOR-TUBO A RAD.	21891	MANGUERA SILICÓN-MOTOR A TUBO	SIH250363C
MANGUERA SILICÓN-TUBO A RAD.	SIH250363C	MANGUERA SUPERIOR-MOTOR A TUBO	21135
MANGUERA INFERIOR-RAD. A TUBO	21135	BANDA-ALT-VENT	K120979
MANGUERA SUPERIOR-RAD. A TUBO	21135	TENSOR-ALT-VENT	38587
MANGUERA SILICÓN-MOTOR A TUBO	SIH250363C	BANDA-AA	K060637
MANGUERA SUPERIOR-MOTOR A TUBO	21135	POLEA-AA	36223
BANDA-ALT-VENT	K120979	TENSOR-AA	38610
TENSOR-ALT-VENT	38587	POLEA DEL TENSOR-	36165
BANDA-AA	K060637	2002	
POLEA-AA	36223	BANDA-VENT	K100719
TENSOR-AA	38610	POLEA DEL TENSOR-VENT	36092
POLEA DEL TENSOR-	36165	TENSOR-VENT	38535
2005		MANGUERA INFERIOR-TUBO A RAD.	21135
MANGUERA INFERIOR-TUBO A RAD.	21891	MANGUERA SUPERIOR-TUBO A RAD.	21891
MANGUERA SILICÓN-TUBO A RAD.	SIH250363C	BANDA-TOMA DE FUERZA-ALT-AA	K060685
MANGUERA INFERIOR-RAD. A TUBO	21135	POLEA DEL TENSOR-TOMA DE FUERZA-ALT-AA	36095
MANGUERA SUPERIOR-RAD. A TUBO	21135	TENSOR-TOMA DE FUERZA-ALT-AA	38532
MANGUERA SILICÓN-MOTOR A TUBO	SIH250363C	MANGUERA INFERIOR-MOTOR A TUBO	21891
MANGUERA SUPERIOR-MOTOR A TUBO	21135	MANGUERA SUPERIOR-MOTOR A TUBO	21135
BANDA-ALT-VENT	K120979	2001	
TENSOR-ALT-VENT	38587	BANDA-VENT	K100719



MASTER SERVICIO PESADO 2014

INTERNATIONAL/
NAVISTAR
99001

POLEA DEL TENSOR-VENT	36092	MANGUERA INFERIOR-MOTOR A TUBO	21135
TENSOR-VENT	38535	MANGUERA SUPERIOR-MOTOR A TUBO	CHARTER 2 1/2"
MANGUERA INFERIOR-TUBO A RAD.	21135	2000	
MANGUERA SUPERIOR-TUBO A RAD.	21891	BANDA-VENT	K080565
BANDA-TOMA DE FUERZA-ALT-AA	K060685	MANGUERA SILICÓN-TUBO A RAD.	SIH250363C
POLEA DEL TENSOR-TOMA DE FUERZA-ALT-AA	36095	MANGUERA SUPERIOR-TUBO A RAD.	21135
TENSOR-TOMA DE FUERZA-ALT-AA	38532	BANDA-TOMA DE FUERZA-ALT	K050336
MANGUERA INFERIOR-MOTOR A TUBO	21891	BANDA-TOMA DE FUERZA-AA	TR22485
MANGUERA SUPERIOR-MOTOR A TUBO	21135	MANGUERA INFERIOR-MOTOR A TUBO	21135
2000		MANGUERA SILICÓN-MOTOR A TUBO	SIH250363C
BANDA-VENT	K100719	CATERPILLAR C16 DIESEL	
POLEA DEL TENSOR-VENT	36092	2003	
TENSOR-VENT	38535	BANDA-VENT-AA	K060500
MANGUERA INFERIOR-TUBO A RAD.	21135	MANGUERA INFERIOR-TUBO A RAD.	21135
MANGUERA SUPERIOR-TUBO A RAD.	21891	MANGUERA SUPERIOR-TUBO A RAD.	21135
BANDA-TOMA DE FUERZA-ALT-AA	K060685	MANGUERA SILICÓN-MOTOR A TUBO	SIH250363C
POLEA DEL TENSOR-TOMA DE FUERZA-ALT-AA	36095	BANDA-ALT-VENT	K100771
TENSOR-TOMA DE FUERZA-ALT-AA	38532	TERMOSTATO-190°	33579
MANGUERA INFERIOR-MOTOR A TUBO	21891	TERMOSTATO-180°	33576
MANGUERA SILICÓN-MOTOR A TUBO	SIH250363C	TERMOSTATO-180°	33578
CUMMINS ISM DIESEL		TERMOSTATO-170°	33577
2003		2002	
BANDA-VENT	K080565	BANDA-VENT-AA	K060500
MANGUERA INFERIOR-TUBO A RAD.	CHARTER 2 1/2"	MANGUERA INFERIOR-TUBO A RAD.	21135
MANGUERA SUPERIOR-TUBO A RAD.	21135	MANGUERA SUPERIOR-TUBO A RAD.	21135
BANDA-TOMA DE FUERZA-ALT	K050336	MANGUERA SILICÓN-MOTOR A TUBO	SIH250363C
BANDA-TOMA DE FUERZA-AA	TR22485	BANDA-ALT-VENT	K100771
MANGUERA INFERIOR-MOTOR A TUBO	21135	TERMOSTATO-190°	33579
MANGUERA SUPERIOR-MOTOR A TUBO	CHARTER 2 1/2"	TERMOSTATO-180°	33576
2002		TERMOSTATO-180°	33578
BANDA-VENT	K080565	TERMOSTATO-170°	33577
MANGUERA INFERIOR-TUBO A RAD.	CHARTER 2 1/2"	2001	
MANGUERA SUPERIOR-TUBO A RAD.	21135	BANDA-VENT-AA	K060500
BANDA-TOMA DE FUERZA-ALT	K050336	MANGUERA INFERIOR-TUBO A RAD.	CHARTER 2 1/2"
BANDA-TOMA DE FUERZA-AA	TR22485	MANGUERA SUPERIOR-TUBO A RAD.	CHARTER 2 1/2"
MANGUERA INFERIOR-MOTOR A TUBO	21135	MANGUERA INFERIOR-MOTOR A TUBO	21135
MANGUERA SUPERIOR-MOTOR A TUBO	CHARTER 2 1/2"	MANGUERA SUPERIOR-MOTOR A TUBO	21135
2001		BANDA-ALT-VENT	K100771
BANDA-VENT	K080565	TERMOSTATO-190°	33579
MANGUERA INFERIOR-TUBO A RAD.	CHARTER 2 1/2"	TERMOSTATO-180°	33576
MANGUERA SUPERIOR-TUBO A RAD.	21135	TERMOSTATO-180°	33578
BANDA-TOMA DE FUERZA-ALT	K050336	TERMOSTATO-170°	33577
BANDA-TOMA DE FUERZA-AA	TR22485	2000	



MASTER SERVICIO PESADO 2014

INTERNATIONAL/
NAVISTAR
9900I

BANDA-VENT-AA	K060500	BANDA-VENT-AA	K060557
MANGUERA SILICÓN-TUBO A RAD.	SIH250363C	POLEA DEL TENSOR-VENT-AA	36091
MANGUERA INFERIOR-MOTOR A TUBO	21135	TENSOR-VENT-AA	38511
MANGUERA SUPERIOR-MOTOR A TUBO	21135	MANGUERA SILICÓN-RAD. A TUBO	SIH250363C
BANDA-ALT-VENT	K100771	MANGUERA SUPERIOR-RAD. A TUBO	21135
TERMOSTATO-190°	33579	MANGUERA SILICÓN-MOTOR A RAD.	SIH300363C
TERMOSTATO-180°	33576	MANGUERA SUPERIOR-MOTOR A RAD.	21891
TERMOSTATO-180°	33578	POLEA-MOTOR	36091
TERMOSTATO-170°	33577	POLEA-MOTOR	36341

CATERPILLAR C15 DIESEL

2008

BANDA-VENT-AA	K060557	BANDA-ALT-VENT	K081092
POLEA DEL TENSOR-VENT-AA	36091	TENSOR-ALT-VENT	38569
TENSOR-VENT-AA	38511	TERMOSTATO-190°	33579
MANGUERA SILICÓN-RAD. A TUBO	SIH250363C	TERMOSTATO-180°	33576
MANGUERA SUPERIOR-RAD. A TUBO	21135	TERMOSTATO-180°	33578
MANGUERA SILICÓN-MOTOR A RAD.	SIH300363C	TERMOSTATO-170°	33577
MANGUERA SUPERIOR-MOTOR A RAD.	21891		
POLEA-MOTOR	36091		
POLEA-MOTOR	36341		

2005

BANDA-VENT-AA	K060557	BANDA-VENT-AA	K060557
POLEA DEL TENSOR-VENT-AA	36091	POLEA DEL TENSOR-VENT-AA	36091
TENSOR-VENT-AA	38511	TENSOR-VENT-AA	38511
MANGUERA SILICÓN-RAD. A TUBO	SIH250363C	MANGUERA SILICÓN-RAD. A TUBO	SIH250363C
MANGUERA SUPERIOR-RAD. A TUBO	21135	MANGUERA SUPERIOR-RAD. A TUBO	21135
MANGUERA SILICÓN-MOTOR A RAD.	SIH300363C	MANGUERA SILICÓN-MOTOR A RAD.	SIH300363C
MANGUERA SUPERIOR-MOTOR A RAD.	21891	MANGUERA SUPERIOR-MOTOR A RAD.	21891
POLEA-MOTOR	36091	POLEA-MOTOR	36091
POLEA-MOTOR	36341	POLEA-MOTOR	36341
BANDA-ALT-VENT	K081092	BANDA-ALT-VENT	K081092
TENSOR-ALT-VENT	38569	TENSOR-ALT-VENT	38569
TERMOSTATO-190°	33579	TERMOSTATO-190°	33579
TERMOSTATO-180°	33576	TERMOSTATO-180°	33576
TERMOSTATO-180°	33578	TERMOSTATO-180°	33578
TERMOSTATO-170°	33577	TERMOSTATO-170°	33577

2007

BANDA-VENT-AA	K060557	BANDA-VENT-AA	K060557
POLEA DEL TENSOR-VENT-AA	36091	POLEA DEL TENSOR-VENT-AA	36091
TENSOR-VENT-AA	38511	TENSOR-VENT-AA	38511
MANGUERA SILICÓN-RAD. A TUBO	SIH250363C	MANGUERA SILICÓN-RAD. A TUBO	SIH250363C
MANGUERA SUPERIOR-RAD. A TUBO	21135	MANGUERA SUPERIOR-RAD. A TUBO	21135
MANGUERA SILICÓN-MOTOR A RAD.	SIH300363C	MANGUERA SILICÓN-MOTOR A RAD.	SIH300363C
MANGUERA SUPERIOR-MOTOR A RAD.	21891	MANGUERA SUPERIOR-MOTOR A RAD.	21891
POLEA-MOTOR	36091	POLEA-MOTOR	36091
POLEA-MOTOR	36341	POLEA-MOTOR	36341
BANDA-ALT-VENT	K081092	BANDA-ALT-VENT	K081092
TENSOR-ALT-VENT	38569	TENSOR-ALT-VENT	38569
TERMOSTATO-190°	33579	TERMOSTATO-190°	33579
TERMOSTATO-180°	33576	TERMOSTATO-180°	33576
TERMOSTATO-180°	33578	TERMOSTATO-180°	33578
TERMOSTATO-170°	33577	TERMOSTATO-170°	33577

2006



MASTER SERVICIO PESADO 2014

INTERNATIONAL/
NAVISTAR
99001

TENSOR-ALT-VENT	38569	TERMOSTATO-180°	33576
TERMOSTATO-190°	33579	TERMOSTATO-180°	33578
TERMOSTATO-180°	33576	TERMOSTATO-170°	33577
TERMOSTATO-180°	33578	CATERPILLAR C13 DIESEL	
TERMOSTATO-170°	33577	2008	
2003		POLEA-MOTOR	36341
BANDA-VENT-AA	K060500	TERMOSTATO-190°	33579
MANGUERA INFERIOR-TUBO A RAD.	21135	TERMOSTATO-180°	33576
MANGUERA SUPERIOR-TUBO A RAD.	21135	TERMOSTATO-180°	33578
MANGUERA SILICÓN-MOTOR A TUBO	SIH250363C	TERMOSTATO-170°	33577
BANDA-ALT-VENT	K100771	2007	
TERMOSTATO-190°	33579	POLEA-MOTOR	36341
TERMOSTATO-180°	33576	TERMOSTATO-190°	33579
TERMOSTATO-180°	33578	TERMOSTATO-180°	33576
TERMOSTATO-170°	33577	TERMOSTATO-180°	33578
		TERMOSTATO-170°	33577
2002		2006	
BANDA-VENT-AA	K060500	POLEA-MOTOR	36093
MANGUERA INFERIOR-TUBO A RAD.	21135	POLEA-MOTOR	36341
MANGUERA SUPERIOR-TUBO A RAD.	21135	TERMOSTATO-190°	33579
MANGUERA SILICÓN-MOTOR A TUBO	SIH250363C	TERMOSTATO-180°	33576
BANDA-ALT-VENT	K100771	TERMOSTATO-180°	33578
TERMOSTATO-190°	33579	TERMOSTATO-170°	33577
TERMOSTATO-180°	33576		
TERMOSTATO-180°	33578	2005	
TERMOSTATO-170°	33577	POLEA-MOTOR	36093
		POLEA-MOTOR	36341
2001		TERMOSTATO-190°	33579
BANDA-VENT-AA	K060500	TERMOSTATO-180°	33576
MANGUERA INFERIOR-TUBO A RAD.	CHARTER 2 1/2"	TERMOSTATO-180°	33578
MANGUERA SUPERIOR-TUBO A RAD.	CHARTER 2 1/2"	TERMOSTATO-170°	33577
MANGUERA INFERIOR-MOTOR A TUBO	21135		
MANGUERA SUPERIOR-MOTOR A TUBO	21135	2004	
BANDA-ALT-VENT	K100771	POLEA-MOTOR	36093
TERMOSTATO-190°	33579	POLEA-MOTOR	36341
TERMOSTATO-180°	33576	TERMOSTATO-190°	33579
TERMOSTATO-180°	33578	TERMOSTATO-180°	33576
TERMOSTATO-170°	33577	TERMOSTATO-180°	33578
		TERMOSTATO-170°	33577
2000		CATERPILLAR C12 DIESEL	
BANDA-VENT-AA	K060500	2004	
MANGUERA SILICÓN-TUBO A RAD.	SIH250363C	POLEA-ALT-VENT	36091
MANGUERA INFERIOR-MOTOR A TUBO	21135	BANDA-AA	K060470
MANGUERA SUPERIOR-MOTOR A TUBO	21135	TERMOSTATO-190°	33579
BANDA-ALT-VENT	K100771	TERMOSTATO-180°	33576
TERMOSTATO-190°	33579		



MASTER SERVICIO PESADO 2014

INTERNATIONAL/
NAVISTAR
9900I

TERMOSTATO-180°	33578	MANGUERA INFERIOR-RAD. A TUBO	21135
TERMOSTATO-170°	33577	MANGUERA INFERIOR-MOTOR A TUBO	21891
2003		MANGUERA SUPERIOR-MOTOR A TUBO	21135
BANDA-VENT-AA	2/9463PB	BANDA-ALT-VENT	K080733
BANDA-VENT-AA	9463	TERMOSTATO-190°	33579
MANGUERA SILICÓN-TUBO A RAD.	SIH250363C	TERMOSTATO-180°	33576
MANGUERA INFERIOR-RAD. A TUBO	21135	TERMOSTATO-180°	33578
MANGUERA INFERIOR-MOTOR A TUBO	21891	TERMOSTATO-170°	33577
MANGUERA SUPERIOR-MOTOR A TUBO	21135		
BANDA-ALT-VENT	K080733	CATERPILLAR C10 DIESEL	
POLEA-ALT-VENT	36091	2002	
TERMOSTATO-190°	33579	BANDA-VENT-AA	2/9463PB
TERMOSTATO-180°	33576	BANDA-VENT-AA	9463
TERMOSTATO-180°	33578	MANGUERA SILICÓN-TUBO A RAD.	SIH250363C
TERMOSTATO-170°	33577	MANGUERA INFERIOR-RAD. A TUBO	21135
		MANGUERA INFERIOR-MOTOR A TUBO	21891
2002		MANGUERA SUPERIOR-MOTOR A TUBO	21135
BANDA-VENT-AA	2/9463PB	BANDA-ALT-VENT	K080733
BANDA-VENT-AA	9463	TERMOSTATO-190°	33579
MANGUERA SILICÓN-TUBO A RAD.	SIH250363C	TERMOSTATO-180°	33576
MANGUERA INFERIOR-RAD. A TUBO	21135	TERMOSTATO-180°	33578
MANGUERA INFERIOR-MOTOR A TUBO	21891	TERMOSTATO-170°	33577
MANGUERA SUPERIOR-MOTOR A TUBO	21135		
BANDA-ALT-VENT	K080733	2001	
TERMOSTATO-190°	33579	BANDA-VENT-AA	2/9463PB
TERMOSTATO-180°	33576	BANDA-VENT-AA	9463
TERMOSTATO-180°	33578	MANGUERA SILICÓN-TUBO A RAD.	SIH250363C
TERMOSTATO-170°	33577	MANGUERA INFERIOR-RAD. A TUBO	21135
		MANGUERA INFERIOR-MOTOR A TUBO	21891
2001		MANGUERA SUPERIOR-MOTOR A TUBO	21135
BANDA-VENT-AA	2/9463PB	BANDA-ALT-VENT	K080733
BANDA-VENT-AA	9463	TERMOSTATO-190°	33579
MANGUERA SILICÓN-TUBO A RAD.	SIH250363C	TERMOSTATO-180°	33576
MANGUERA INFERIOR-RAD. A TUBO	21135	TERMOSTATO-180°	33578
MANGUERA INFERIOR-MOTOR A TUBO	21891	TERMOSTATO-170°	33577
MANGUERA SUPERIOR-MOTOR A TUBO	21135		
BANDA-ALT-VENT	K080733	2000	
TERMOSTATO-190°	33579	BANDA-VENT-AA	2/9463PB
TERMOSTATO-180°	33576	BANDA-VENT-AA	9463
TERMOSTATO-180°	33578	MANGUERA SILICÓN-TUBO A RAD.	SIH250363C
TERMOSTATO-170°	33577	MANGUERA INFERIOR-RAD. A TUBO	21135
		MANGUERA INFERIOR-MOTOR A TUBO	21891
2000		MANGUERA SUPERIOR-MOTOR A TUBO	21135
BANDA-VENT-AA	2/9463PB	BANDA-ALT-VENT	K080733
BANDA-VENT-AA	9463	TERMOSTATO-190°	33579
MANGUERA SILICÓN-TUBO A RAD.	SIH250363C	TERMOSTATO-180°	33576



TERMOSTATO-180°	33578	2002	
TERMOSTATO-170°	33577	BANDA-VENT	K100540
CATERPILLAR 3406 DIESEL		MANGUERA INFERIOR-RAD. A TUBO	21135
2003		MANGUERA SUPERIOR-RAD. A TUBO	21135
TERMOSTATO-190°	33579	MANGUERA SILICÓN-MOTOR A TUBO	SIH250363C
TERMOSTATO-180°	33576	TERMOSTATO-190°	33599
TERMOSTATO-180°	33578	2001	
TERMOSTATO-170°	33577	BANDA-VENT	K100540
2002		POLEA DEL TENSOR-VENT	36092
TERMOSTATO-190°	33579	TENSOR-VENT	38519
TERMOSTATO-180°	33576	MANGUERA INFERIOR-TUBO A RAD.	21135
TERMOSTATO-180°	33578	MANGUERA SUPERIOR-TUBO A RAD.	21135
TERMOSTATO-170°	33577	MANGUERA SILICÓN-MOTOR A TUBO	SIH250363C
2001		MANGUERA SUPERIOR-MOTOR A TUBO	21891
TERMOSTATO-190°	33579	BANDA-ALT	K060455
TERMOSTATO-180°	33576	BANDA-AA	K060340
TERMOSTATO-180°	33578	CUMMINS N14 DIESEL	
TERMOSTATO-170°	33577	2003	
2000		MANGUERA INFERIOR-TUBO A RAD.	21135
BANDA-VENT-AA	K060500	MANGUERA SUPERIOR-TUBO A RAD.	21135
MANGUERA SILICÓN-TUBO A RAD.	SIH250363C	BANDA-TOMA DE FUERZA-VENT	K100465
MANGUERA SUPERIOR-TUBO A RAD.	21135	BANDA-TOMA DE FUERZA-BA	K060425
MANGUERA INFERIOR-MOTOR A TUBO	CHARTER 3"	BANDA-TOMA DE FUERZA-AA	9405
MANGUERA SILICÓN-MOTOR A TUBO	SIH250363C	MANGUERA INFERIOR-MOTOR A TUBO	CHARTER 2 1/2"
BANDA-ALT-VENT	K100771	MANGUERA SILICÓN-MOTOR A TUBO	SIH250363C
TERMOSTATO-190°	33579	BANDA-ALT	9447
TERMOSTATO-180°	33576	TERMOSTATO-190°	33579
TERMOSTATO-180°	33578	TERMOSTATO-180°	33576
TERMOSTATO-170°	33577	TERMOSTATO-180°	33578
9900IX		TERMOSTATO-170°	33577
DETROIT DIESEL SERIE 60		2002	
2000		BANDA-VENT	K100465
BANDA-VENT	K100540	MANGUERA INFERIOR-TUBO A RAD.	21135
POLEA DEL TENSOR-VENT	36092	MANGUERA SUPERIOR-TUBO A RAD.	21135
TENSOR-VENT	38519	BANDA-TOMA DE FUERZA-AA	9405
MANGUERA INFERIOR-TUBO A RAD.	21135	MANGUERA SILICÓN-MOTOR A TUBO	SIH250363C
MANGUERA SUPERIOR-TUBO A RAD.	21135	BANDA-BA	K060415
MANGUERA SILICÓN-MOTOR A TUBO	SIH250363C	BANDA-ALT	2/9447PB
MANGUERA SUPERIOR-MOTOR A TUBO	21891	BANDA-ALT	9447
BANDA-ALT	K060455	TERMOSTATO-190°	33579
BANDA-AA	K060340	TERMOSTATO-180°	33576
TERMOSTATO-190°	33599	TERMOSTATO-180°	33578
DETROIT DIESEL 6 CIL, 12.7 L DIESEL		TERMOSTATO-170°	33577



MASTER SERVICIO PESADO 2014

INTERNATIONAL/
NAVISTAR
9900IX

2001

BANDA-VENT	K100465
MANGUERA INFERIOR-TUBO A RAD.	21135
MANGUERA SUPERIOR-TUBO A RAD.	21135
BANDA-TOMA DE FUERZA-AA	9405
MANGUERA SILICÓN-MOTOR A TUBO	SIH250363C
BANDA-BA	K060415
BANDA-ALT	2/9447PB
BANDA-ALT	9447
TERMOSTATO-190°	33579
TERMOSTATO-180°	33576
TERMOSTATO-180°	33578
TERMOSTATO-170°	33577

2000

BANDA-VENT	K100465
MANGUERA INFERIOR-TUBO A RAD.	21135
MANGUERA SUPERIOR-TUBO A RAD.	21135
BANDA-TOMA DE FUERZA-AA	9405
MANGUERA SILICÓN-MOTOR A TUBO	SIH250363C
BANDA-BA	K060415
BANDA-ALT	2/9447PB
BANDA-ALT	9447
TERMOSTATO-190°	33579
TERMOSTATO-180°	33576
TERMOSTATO-180°	33578
TERMOSTATO-170°	33577

CUMMINS ISX DIESEL

2007

MANGUERA SILICÓN-TUBO A RAD.	SIH250363C
MANGUERA SUPERIOR-RAD. A TUBO	21135
MANGUERA SILICÓN-MOTOR A TUBO	SIH250363C
MANGUERA SUPERIOR-MOTOR A TUBO	21135
BANDA-ALT-VENT	K120979
TENSOR-ALT-VENT	38587
BANDA-AA	K060637

2006

MANGUERA INFERIOR-TUBO A RAD.	21891
MANGUERA SUPERIOR-RAD. A TUBO	21135
MANGUERA INFERIOR-MOTOR A TUBO	21115
MANGUERA SUPERIOR-MOTOR A TUBO	21135
BANDA-ALT-VENT	K120979
TENSOR-ALT-VENT	38587
BANDA-AA	K060637

2005

MANGUERA SILICÓN-TUBO A RAD.	SIH250363C
MANGUERA SUPERIOR-RAD. A TUBO	21135
MANGUERA SILICÓN-MOTOR A TUBO	SIH250363C
MANGUERA SUPERIOR-MOTOR A TUBO	21135
BANDA-ALT-VENT	K120979
TENSOR-ALT-VENT	38587
BANDA-AA	K060637

2004

MANGUERA SILICÓN-TUBO A RAD.	SIH250363C
MANGUERA SUPERIOR-RAD. A TUBO	21135
MANGUERA SILICÓN-MOTOR A TUBO	SIH250363C
MANGUERA SUPERIOR-MOTOR A TUBO	21135
BANDA-ALT-VENT	K120979
TENSOR-ALT-VENT	38587
BANDA-AA	K060637

2003

BANDA-VENT	K100719
POLEA DEL TENSOR-VENT	36092
TENSOR-VENT	38535
MANGUERA SILICÓN-TUBO A RAD.	SIH250363C
MANGUERA SUPERIOR-TUBO A RAD.	21891
BANDA-TOMA DE FUERZA-ALT-AA	K060685
POLEA DEL TENSOR-TOMA DE FUERZA-ALT-AA	36095
TENSOR-TOMA DE FUERZA-ALT-AA	38532
MANGUERA SUPERIOR-RAD. A TUBO	21135
MANGUERA SILICÓN-MOTOR A TUBO	SIH250363C
MANGUERA SUPERIOR-MOTOR A TUBO	21135
BANDA-ALT-VENT-C/PURIF DE AIRE	K120979
TENSOR-ALT-VENT	38587
BANDA-AA-C/PURIF DE AIRE	K060637

2002

BANDA-VENT	K100719
POLEA DEL TENSOR-VENT	36092
TENSOR-VENT	38535
MANGUERA INFERIOR-TUBO A RAD.	21135
MANGUERA SUPERIOR-TUBO A RAD.	21891
BANDA-TOMA DE FUERZA-ALT-AA	K060685
POLEA DEL TENSOR-TOMA DE FUERZA-ALT-AA	36095
TENSOR-TOMA DE FUERZA-ALT-AA	38532
MANGUERA INFERIOR-MOTOR A TUBO	21891
MANGUERA SUPERIOR-MOTOR A TUBO	21135

2001



MASTER SERVICIO PESADO 2014

INTERNATIONAL/
NAVISTAR
9900IX

BANDA-VENT	K100719	BANDA-TOMA DE FUERZA-AA	TR22485
POLEA DEL TENSOR-VENT	36092	MANGUERA INFERIOR-MOTOR A TUBO	21135
TENSOR-VENT	38535	MANGUERA SILICÓN-MOTOR A TUBO	SIH250363C
MANGUERA INFERIOR-TUBO A RAD.	21135	CATERPILLAR C16 DIESEL	
MANGUERA SUPERIOR-TUBO A RAD.	21891	2002	
BANDA-TOMA DE FUERZA-ALT-AA	K060685	BANDA-VENT-AA	K060500
POLEA DEL TENSOR-TOMA DE FUERZA-ALT-AA	36095	MANGUERA INFERIOR-TUBO A RAD.	21135
TENSOR-TOMA DE FUERZA-ALT-AA	38532	MANGUERA SUPERIOR-TUBO A RAD.	21135
MANGUERA INFERIOR-MOTOR A TUBO	21891	MANGUERA SILICÓN-MOTOR A TUBO	SIH250363C
MANGUERA SUPERIOR-MOTOR A TUBO	21135	BANDA-ALT-VENT	K100771
2000		TERMOSTATO-190°	33579
BANDA-VENT	K100719	TERMOSTATO-180°	33576
POLEA DEL TENSOR-VENT	36092	TERMOSTATO-180°	33578
TENSOR-VENT	38535	TERMOSTATO-170°	33577
MANGUERA INFERIOR-TUBO A RAD.	21135	2001	
MANGUERA SUPERIOR-TUBO A RAD.	21891	BANDA-VENT-AA	K060500
BANDA-TOMA DE FUERZA-ALT-AA	K060685	MANGUERA INFERIOR-TUBO A RAD.	CHARTER 2 1/2"
POLEA DEL TENSOR-TOMA DE FUERZA-ALT-AA	36095	MANGUERA SUPERIOR-TUBO A RAD.	CHARTER 2 1/2"
TENSOR-TOMA DE FUERZA-ALT-AA	38532	MANGUERA INFERIOR-MOTOR A TUBO	21135
MANGUERA INFERIOR-MOTOR A TUBO	21891	MANGUERA SUPERIOR-MOTOR A TUBO	21135
MANGUERA SILICÓN-MOTOR A TUBO	SIH250363C	BANDA-ALT-VENT	K100771
CUMMINS ISM DIESEL		TERMOSTATO-190°	33579
2002		TERMOSTATO-180°	33576
BANDA-VENT	K080565	TERMOSTATO-180°	33578
MANGUERA INFERIOR-TUBO A RAD.	CHARTER 2 1/2"	TERMOSTATO-170°	33577
MANGUERA SUPERIOR-TUBO A RAD.	21135	2000	
BANDA-TOMA DE FUERZA-ALT	K050336	BANDA-VENT-AA	K060500
BANDA-TOMA DE FUERZA-AA	TR22485	MANGUERA SILICÓN-TUBO A RAD.	SIH250363C
MANGUERA INFERIOR-MOTOR A TUBO	21135	MANGUERA INFERIOR-MOTOR A TUBO	21135
MANGUERA SUPERIOR-MOTOR A TUBO	CHARTER 2 1/2"	MANGUERA SUPERIOR-MOTOR A TUBO	21135
2001		BANDA-ALT-VENT	K100771
BANDA-VENT	K080565	TERMOSTATO-190°	33579
MANGUERA INFERIOR-TUBO A RAD.	CHARTER 2 1/2"	TERMOSTATO-180°	33576
MANGUERA SUPERIOR-TUBO A RAD.	21135	TERMOSTATO-180°	33578
BANDA-TOMA DE FUERZA-ALT	K050336	TERMOSTATO-170°	33577
BANDA-TOMA DE FUERZA-AA	TR22485	CATERPILLAR C15 DIESEL	
MANGUERA INFERIOR-MOTOR A TUBO	21135	2008	
MANGUERA SUPERIOR-MOTOR A TUBO	CHARTER 2 1/2"	TERMOSTATO-190°	33579
2000		TERMOSTATO-180°	33576
BANDA-VENT	K080565	TERMOSTATO-180°	33578
MANGUERA SILICÓN-TUBO A RAD.	SIH250363C	TERMOSTATO-170°	33577
MANGUERA SUPERIOR-TUBO A RAD.	21135	2007	
BANDA-TOMA DE FUERZA-ALT	K050336	BANDA-VENT-AA	K060557



MASTER SERVICIO PESADO 2014

INTERNATIONAL/
NAVISTAR
9900IX

POLEA DEL TENSOR-VENT-AA	36091	TERMOSTATO-190°	33579
TENSOR-VENT-AA	38511	TERMOSTATO-180°	33576
MANGUERA SILICÓN-RAD. A TUBO	SIH250363C	TERMOSTATO-180°	33578
MANGUERA SUPERIOR-RAD. A TUBO	21135	TERMOSTATO-170°	33577
MANGUERA SILICÓN-MOTOR A RAD.	SIH300363C	2004	
MANGUERA SUPERIOR-MOTOR A RAD.	21891	BANDA-VENT-AA	K060557
POLEA-MOTOR	36091	POLEA DEL TENSOR-VENT-AA	36091
POLEA-MOTOR	36093	TENSOR-VENT-AA	38511
BANDA-ALT-VENT	K081092	MANGUERA SILICÓN-RAD. A TUBO	SIH250363C
TENSOR-ALT-VENT	38569	MANGUERA SUPERIOR-RAD. A TUBO	21135
TERMOSTATO-190°	33579	MANGUERA SILICÓN-MOTOR A RAD.	SIH300363C
TERMOSTATO-180°	33576	MANGUERA SUPERIOR-MOTOR A RAD.	21891
TERMOSTATO-180°	33578	POLEA-MOTOR	36091
TERMOSTATO-170°	33577	POLEA-MOTOR	36093
2006		BANDA-ALT-VENT	K081092
BANDA-VENT-AA	K060557	TENSOR-ALT-VENT	38569
POLEA DEL TENSOR-VENT-AA	36091	TERMOSTATO-190°	33579
TENSOR-VENT-AA	38511	TERMOSTATO-180°	33576
MANGUERA SILICÓN-RAD. A TUBO	SIH250363C	TERMOSTATO-180°	33578
MANGUERA SUPERIOR-RAD. A TUBO	21135	TERMOSTATO-170°	33577
MANGUERA SILICÓN-MOTOR A RAD.	SIH300363C	2003	
MANGUERA SUPERIOR-MOTOR A RAD.	21891	BANDA-VENT-AA	K060500
POLEA-MOTOR	36091	MANGUERA INFERIOR-TUBO A RAD.	21135
POLEA-MOTOR	36093	MANGUERA SUPERIOR-TUBO A RAD.	21135
BANDA-ALT-VENT	K081092	MANGUERA SILICÓN-MOTOR A TUBO	SIH250363C
TENSOR-ALT-VENT	38569	BANDA-ALT-VENT	K100771
TERMOSTATO-190°	33579	TERMOSTATO-190°	33579
TERMOSTATO-180°	33576	TERMOSTATO-180°	33576
TERMOSTATO-180°	33578	TERMOSTATO-180°	33578
TERMOSTATO-170°	33577	TERMOSTATO-170°	33577
2005		2002	
BANDA-VENT-AA	K060557	BANDA-VENT-AA	K060500
POLEA DEL TENSOR-VENT-AA	36091	MANGUERA INFERIOR-TUBO A RAD.	21135
TENSOR-VENT-AA	38511	MANGUERA SUPERIOR-TUBO A RAD.	21135
MANGUERA SILICÓN-RAD. A TUBO	SIH250363C	MANGUERA SILICÓN-MOTOR A TUBO	SIH250363C
MANGUERA SUPERIOR-RAD. A TUBO	21135	BANDA-ALT-VENT	K100771
MANGUERA SILICÓN-MOTOR A RAD.	SIH300363C	TERMOSTATO-190°	33579
MANGUERA SUPERIOR-MOTOR A RAD.	21891	TERMOSTATO-180°	33576
POLEA-MOTOR	36091	TERMOSTATO-180°	33578
POLEA-MOTOR	36093	TERMOSTATO-170°	33577
BANDA-ALT-VENT	K081092	2001	
TENSOR-ALT-VENT	38569	BANDA-VENT-AA	K060500
		MANGUERA INFERIOR-TUBO A RAD.	CHARTER 2 1/2"



MASTER SERVICIO PESADO 2014

INTERNATIONAL/
NAVISTAR
9900IX

MANGUERA SUPERIOR-TUBO A RAD.	CHARTER 2 1/2"	TERMOSTATO-170°	33577
MANGUERA INFERIOR-MOTOR A TUBO	21135	2001	
MANGUERA SUPERIOR-MOTOR A TUBO	21135	BANDA-VENT-AA	2/9463PB
BANDA-ALT-VENT	K100771	BANDA-VENT-AA	9463
TERMOSTATO-190°	33579	MANGUERA SILICÓN-TUBO A RAD.	SIH250363C
TERMOSTATO-180°	33576	MANGUERA INFERIOR-RAD. A TUBO	21135
TERMOSTATO-180°	33578	MANGUERA INFERIOR-MOTOR A TUBO	21891
TERMOSTATO-170°	33577	MANGUERA SUPERIOR-MOTOR A TUBO	21135
2000		BANDA-ALT-VENT	K080733
BANDA-VENT-AA	K060500	TERMOSTATO-190°	33579
MANGUERA SILICÓN-TUBO A RAD.	SIH250363C	TERMOSTATO-180°	33576
MANGUERA INFERIOR-MOTOR A TUBO	21135	TERMOSTATO-180°	33578
MANGUERA SUPERIOR-MOTOR A TUBO	21135	TERMOSTATO-170°	33577
BANDA-ALT-VENT	K100771	2000	
TERMOSTATO-190°	33579	BANDA-VENT-AA	2/9463PB
TERMOSTATO-180°	33576	BANDA-VENT-AA	9463
TERMOSTATO-180°	33578	MANGUERA SILICÓN-TUBO A RAD.	SIH250363C
TERMOSTATO-170°	33577	MANGUERA INFERIOR-RAD. A TUBO	21135
CATERPILLAR C12 DIESEL		MANGUERA INFERIOR-MOTOR A TUBO	21891
2003		MANGUERA SUPERIOR-MOTOR A TUBO	21135
BANDA-VENT-AA	2/9463PB	BANDA-ALT-VENT	K080733
BANDA-VENT-AA	9463	TERMOSTATO-190°	33579
MANGUERA SILICÓN-TUBO A RAD.	SIH250363C	TERMOSTATO-180°	33576
MANGUERA INFERIOR-RAD. A TUBO	21135	TERMOSTATO-180°	33578
MANGUERA INFERIOR-MOTOR A TUBO	21891	TERMOSTATO-170°	33577
MANGUERA SUPERIOR-MOTOR A TUBO	21135	CATERPILLAR C10 DIESEL	
BANDA-ALT-VENT	K080733	2002	
POLEA-ALT-VENT	36091	BANDA-VENT-AA	2/9463PB
TERMOSTATO-190°	33579	BANDA-VENT-AA	9463
TERMOSTATO-180°	33576	MANGUERA SILICÓN-TUBO A RAD.	SIH250363C
TERMOSTATO-180°	33578	MANGUERA INFERIOR-RAD. A TUBO	21135
TERMOSTATO-170°	33577	MANGUERA INFERIOR-MOTOR A TUBO	21891
2002		MANGUERA SUPERIOR-MOTOR A TUBO	21135
BANDA-VENT-AA	2/9463PB	BANDA-ALT-VENT	K080733
BANDA-VENT-AA	9463	TERMOSTATO-190°	33579
MANGUERA SILICÓN-TUBO A RAD.	SIH250363C	TERMOSTATO-180°	33576
MANGUERA INFERIOR-RAD. A TUBO	21135	TERMOSTATO-180°	33578
MANGUERA INFERIOR-MOTOR A TUBO	21891	TERMOSTATO-170°	33577
MANGUERA SUPERIOR-MOTOR A TUBO	21135	2001	
BANDA-ALT-VENT	K080733	BANDA-VENT-AA	2/9463PB
TERMOSTATO-190°	33579	BANDA-VENT-AA	9463
TERMOSTATO-180°	33576	MANGUERA SILICÓN-TUBO A RAD.	SIH250363C
TERMOSTATO-180°	33578	MANGUERA INFERIOR-RAD. A TUBO	21135



MASTER SERVICIO PESADO 2014

INTERNATIONAL/
NAVISTAR
9900IX

MANGUERA INFERIOR-MOTOR A TUBO	21891	TERMOSTATO-180°	33576
MANGUERA SUPERIOR-MOTOR A TUBO	21135	TERMOSTATO-180°	33578
BANDA-ALT-VENT	K080733	TERMOSTATO-170°	33577
TERMOSTATO-190°	33579	BE	
TERMOSTATO-180°	33576	INTERNATIONAL/NAVISTAR VT365 DIESEL	
TERMOSTATO-180°	33578	2008	
TERMOSTATO-170°	33577	MANGUERA SUPERIOR-RAD. A MOTOR	22774
2000		MANGUERA INFERIOR-MOTOR A BA	22775
BANDA-VENT-AA	2/9463PB	BANDA-ALT-VENT	K080702
BANDA-VENT-AA	9463	TENSOR-ALT-VENT	38556
MANGUERA SILICÓN-TUBO A RAD.	SIH250363C	2007	
MANGUERA INFERIOR-RAD. A TUBO	21135	MANGUERA SUPERIOR-RAD. A MOTOR	22774
MANGUERA INFERIOR-MOTOR A TUBO	21891	MANGUERA INFERIOR-MOTOR A BA	22775
MANGUERA SUPERIOR-MOTOR A TUBO	21135	BANDA-ALT-VENT	K080702
BANDA-ALT-VENT	K080733	TENSOR-ALT-VENT	38556
TERMOSTATO-190°	33579	INTERNATIONAL/NAVISTAR MAXXFORCE 7 DIESEL	
TERMOSTATO-180°	33576	2013	
TERMOSTATO-180°	33578	BANDA-VENT	K081047
TERMOSTATO-170°	33577	POLEA-ALT-VENT	36351
CATERPILLAR 3406 DIESEL		TENSOR-ALT-VENT	38556
2003		MANGUERA INFERIOR-	23793
TERMOSTATO-190°	33579	MANGUERA SUPERIOR-	23795
TERMOSTATO-180°	33576	2012	
TERMOSTATO-180°	33578	BANDA-VENT	K081047
TERMOSTATO-170°	33577	POLEA-ALT-VENT	36351
2002		TENSOR-ALT-VENT	38556
TERMOSTATO-190°	33579	MANGUERA INFERIOR-	23793
TERMOSTATO-180°	33576	MANGUERA SUPERIOR-	23795
TERMOSTATO-180°	33578	2011	
TERMOSTATO-170°	33577	BANDA-VENT	K080991
2001		POLEA-ALT-VENT	36351
TERMOSTATO-190°	33579	TENSOR-ALT-VENT	38556
TERMOSTATO-180°	33576	MANGUERA INFERIOR-	23793
TERMOSTATO-180°	33578	MANGUERA SUPERIOR-	23795
TERMOSTATO-170°	33577	2010	
2000		BANDA-VENT	K080962
BANDA-VENT-AA	K060500	POLEA-ALT-VENT	36351
MANGUERA SILICÓN-TUBO A RAD.	SIH250363C	TENSOR-ALT-VENT	38556
MANGUERA SUPERIOR-TUBO A RAD.	21135	MANGUERA INFERIOR-	23793
MANGUERA INFERIOR-MOTOR A TUBO	CHARTER 3"	MANGUERA SUPERIOR-	23795
MANGUERA SILICÓN-MOTOR A TUBO	SIH250363C	2009	
BANDA-ALT-VENT	K100771	BANDA-VENT	K080962
TERMOSTATO-190°	33579	POLEA-ALT-VENT	36351



TENSOR-ALT-VENT	38556	BANDA-ALT-BA-VENT C/ ALT. BOSCH	K100720
MANGUERA INFERIOR-	23793	TENSOR-ALT-BA-VENT	38634
MANGUERA SUPERIOR-	23795	MANGUERA SUPERIOR-	23794
2008		2009	
MANGUERA INFERIOR-MOTOR A BA	22775	MANGUERA INFERIOR-ENFRIADOR A TUBO	21302
BANDA-ALT-VENT	K080702	BANDA-ALT-BA-VENT C/ALT. PRESTOLITE	K100731
POLEA-ALT-VENT	36351	BANDA-ALT-BA-VENT C/ ALT. BOSCH	K100702
TENSOR-ALT-VENT	38556	TENSOR-ALT-BA-VENT	38634

CE

INTERNATIONAL/NAVISTAR VT365 DIESEL

2007		2008	
BANDA-VENT-COMPRESOR	K060509	MANGUERA SUPERIOR-MOTOR A RAD.	20731
TENSOR-VENT-COMPRESOR	38556	TENSOR-MOTOR	38620
BANDA-ALT-VENT	K080702	BANDA-ALT-BA-VENT	K080726

INTERNATIONAL/NAVISTAR DT466

2008		2008	
TENSOR-ALT-VENT	38556	MANGUERA SUPERIOR-MOTOR A RAD.	20731
2005		TENSOR-MOTOR	38620
BANDA-VENT-COMPRESOR	K060509	BANDA-ALT-BA-VENT	K080726
TENSOR-MOTOR	38556	TERMOSTATO-190°	33179
BANDA-ALT-VENT-AA	K080855	TERMOSTATO-190°	33957
BANDA-ALT-VENT	K080702	TERMOSTATO-180°	33118

INTERNATIONAL/NAVISTAR T444 DIESEL

2004		2007	
MANGUERA SUPERIOR-MOTOR A RAD.	22785	MANGUERA SUPERIOR-MOTOR A RAD.	21115
BANDA-ALT-VENT	K081124	BANDA-ALT-BA-VENT	K080726
TENSOR-ALT-VENT	38510	TENSOR-ALT-BA-VENT	38620
TERMOSTATO-195°	33967	TERMOSTATO-190°	33179
2003		TERMOSTATO-190°	33957
MANGUERA SUPERIOR-MOTOR A RAD.	22785	TERMOSTATO-180°	33118
BANDA-ALT-VENT	K081124	2006	
TENSOR-ALT-VENT	38510	MANGUERA INFERIOR-MOTOR A ENFRIADOR	23176
TERMOSTATO-195°	33967	MANGUERA INFERIOR-ENFRIADOR A RAD.	23175

INTERNATIONAL/NAVISTAR MAXXFORCE DT DIESEL

2012		BANDA-ALT-BA-VENT	K080726
BANDA-ALT-BA-VENT	K100702	TENSOR-ALT-BA-VENT	38620
TENSOR-ALT-BA-VENT	38634	TERMOSTATO-190°	33179
MANGUERA SUPERIOR-	23794	TERMOSTATO-190°	33957
2011		TERMOSTATO-180°	33118
BANDA-ALT-BA-VENT	K100702	2005	
TENSOR-ALT-BA-VENT	38634	BANDA-ALT-BA-VENT-AA C/ALT 120A	K080922
MANGUERA SUPERIOR-	23794	BANDA-ALT-BA-VENT C/ALT 145A	K080726
2010		TENSOR-ALT-BA-VENT	38620
MANGUERA INFERIOR-ENFRIADOR A TUBO	21302	TERMOSTATO-190°	33179
BANDA-ALT-BA-VENT C/ALT. PRESTOLITE	K100726	TERMOSTATO-190°	33957
		TERMOSTATO-180°	33118



MASTER SERVICIO PESADO 2014

INTERNATIONAL/
NAVISTAR
CE

2004

MANGUERA INFERIOR-MOTOR A RAD.	20987
MANGUERA SUPERIOR-MOTOR A RAD.	22776
BANDA-ALT-VENT	K080690
POLEA-ALT-VENT	36091
TENSOR-ALT-VENT	38514
BANDA-AA	K060675
TERMOSTATO-190°	33179
TERMOSTATO-190°	33957
TERMOSTATO-180°	33118

2003

MANGUERA INFERIOR-MOTOR A RAD.	20987
MANGUERA SUPERIOR-MOTOR A RAD.	22776
BANDA-ALT-VENT	K080690
POLEA-ALT-VENT	36091
TENSOR-ALT-VENT	38514
BANDA-AA	K060675
TERMOSTATO-190°	33179
TERMOSTATO-190°	33957
TERMOSTATO-180°	33118

CF500

INTERNATIONAL/NAVISTAR VT275 DIESEL

2008

BANDA-ALT-BA-VENT-AA	K081331
TENSOR-ALT-BA-VENT-AA	38257
TAPÓN DE RADIADOR-(10 LBS) SIN PALANCA	31567

2007

BANDA-ALT-BA-VENT-AA	K081331
TENSOR-ALT-BA-VENT-AA	38257
TAPÓN DE RADIADOR-(10 LBS) SIN PALANCA	31567

2006

BANDA-ALT-BA-VENT-AA	K081331
TENSOR-ALT-BA-VENT-AA	38257
TAPÓN DE RADIADOR-(10 LBS) SIN PALANCA	31567

2005

BANDA-ALT-BA-VENT-AA	K081331
TENSOR-ALT-BA-VENT-AA	38257
TAPÓN DE RADIADOR-(10 LBS) SIN PALANCA	31567

CF600

INTERNATIONAL/NAVISTAR VT275 DIESEL

2008

BANDA-ALT-BA-VENT-AA	K081331
TENSOR-ALT-BA-VENT-AA	38257

TAPÓN DE RADIADOR-(10 LBS) SIN PALANCA

31567

2007

BANDA-ALT-BA-VENT-AA	K081331
TENSOR-ALT-BA-VENT-AA	38257
TAPÓN DE RADIADOR-(10 LBS) SIN PALANCA	31567

2006

BANDA-ALT-BA-VENT-AA	K081331
TENSOR-ALT-BA-VENT-AA	38257
TAPÓN DE RADIADOR-(10 LBS) SIN PALANCA	31567

2005

BANDA-ALT-BA-VENT-AA	K081331
TENSOR-ALT-BA-VENT-AA	38257
TAPÓN DE RADIADOR-(10 LBS) SIN PALANCA	31567

CONVENTIONAL IC

INTERNATIONAL/NAVISTAR T444 DIESEL

2003

MANGUERA INFERIOR-MOTOR A RAD.	22782
BANDA-MOTOR	K081377
TENSOR-MOTOR	38510
TERMOSTATO-195°	33967
POLEA DEL TENSOR-	36092

2002

BANDA-TOMA DE FUERZA-ALT-VENT	K080893
TENSOR-TOMA DE FUERZA-ALT-VENT	38510
MANGUERA INFERIOR-MOTOR A RAD.	22782
MANGUERA SUPERIOR-MOTOR A RAD.	21042
TERMOSTATO-195°	33967

INTERNATIONAL/NAVISTAR DT466

2003

BANDA-TOMA DE FUERZA-ALT-VENT	K080690
POLEA DEL TENSOR-TOMA DE FUERZA-ALT-VENT	36091
TENSOR-TOMA DE FUERZA-ALT-VENT	38514
MANGUERA INFERIOR-MOTOR A RAD.	20987
MANGUERA SUPERIOR-MOTOR A RAD.	22776
TERMOSTATO-190°	33179
TERMOSTATO-190°	33957
TERMOSTATO-180°	33118

2002

BANDA-TOMA DE FUERZA-ALT-VENT	K080690
POLEA DEL TENSOR-TOMA DE FUERZA-ALT-VENT	36091
TENSOR-TOMA DE FUERZA-ALT-VENT	38514
MANGUERA INFERIOR-MOTOR A RAD.	20987
MANGUERA SUPERIOR-MOTOR A RAD.	22776



MASTER SERVICIO PESADO 2014

INTERNATIONAL/
NAVISTAR
CONVENTIONAL IC

TERMOSTATO-190°	33179	TAPÓN DE RADIADOR-(10 LBS) SIN PALANCA	31567
TERMOSTATO-190°	33957	MANGUERA SUPERIOR-	23794
TERMOSTATO-180°	33118	2012	
CXT		BANDA-VENT	K080723
INTERNATIONAL/NAVISTAR DT466		POLEA-VENT	36164
2008		TENSOR-MOTOR	38620
TERMOSTATO-190°	33179	TAPÓN DE RADIADOR-(10 LBS) SIN PALANCA	31567
TERMOSTATO-190°	33957	BOMBA DE AGUA-	43325HD
TERMOSTATO-180°	33118	MANGUERA INFERIOR-	20731
2007		MANGUERA INFERIOR-	21302
TERMOSTATO-190°	33179	MANGUERA SUPERIOR-	23794
TERMOSTATO-190°	33957	2011	
TERMOSTATO-180°	33118	BANDA-VENT	K100870
2006		POLEA-VENT	36164
MANGUERA INFERIOR-TUBO A ENFRIADOR	21891	TENSOR-MOTOR	38634
TENSOR-TOMA DE FUERZA-ALT-VENT-AA	38620	TAPÓN DE RADIADOR-(10 LBS) SIN PALANCA	31567
MANGUERA INFERIOR-RAD. A TUBO	21135	BOMBA DE AGUA-	43325HD
MANGUERA SILICÓN-RAD. A TUBO	SIH250363C	MANGUERA INFERIOR-	21302
MANGUERA INFERIOR-MOTOR A TUBO	21135	MANGUERA SUPERIOR-	23794
MANGUERA SUPERIOR-MOTOR A TUBO	21891	2010	
MANGUERA INFERIOR-ENFRIADOR A TUBO	21891	BANDA-VENT	K081047
BANDA-ALT-BA-VENT-AA	K080926	POLEA-VENT	36164
TERMOSTATO-190°	33179	TENSOR-MOTOR	38556
TERMOSTATO-190°	33957	TAPÓN DE RADIADOR-(10 LBS) SIN PALANCA	31567
TERMOSTATO-180°	33118	BOMBA DE AGUA-	43325HD
2005		MANGUERA INFERIOR-	21302
MANGUERA INFERIOR-TUBO A ENFRIADOR	21891	MANGUERA SUPERIOR-	23794
TENSOR-TOMA DE FUERZA-ALT-VENT-AA	38620	2009	
MANGUERA INFERIOR-RAD. A TUBO	21135	TENSOR-MOTOR	38634
MANGUERA SILICÓN-RAD. A TUBO	SIH250363C	TAPÓN DE RADIADOR-(10 LBS) SIN PALANCA	31567
MANGUERA INFERIOR-MOTOR A TUBO	21135	BANDA-	K100860
MANGUERA SUPERIOR-MOTOR A TUBO	21891	BOMBA DE AGUA-	43325HD
MANGUERA INFERIOR-ENFRIADOR A TUBO	21891	MANGUERA INFERIOR-	21302
BANDA-ALT-BA-VENT-AA	K080926	MANGUERA SUPERIOR-	23794
TERMOSTATO-190°	33179	2008	
TERMOSTATO-190°	33957	TENSOR-MOTOR	38634
TERMOSTATO-180°	33118	TAPÓN DE RADIADOR-(10 LBS) SIN PALANCA	31567
DURASTAR 4300		BANDA-	K100860
INTERNATIONAL/NAVISTAR MAXXFORCE DT DIESEL		BOMBA DE AGUA-	43325HD
2013		MANGUERA INFERIOR-	21302
BANDA-VENT	K100877	MANGUERA SUPERIOR-	23794
POLEA-VENT	36164	INTERNATIONAL/NAVISTAR MAXXFORCE 7 DIESEL	
TENSOR-MOTOR	38634	2012	



MASTER SERVICIO PESADO 2014

INTERNATIONAL/
NAVISTAR
DURASTAR 4300

POLEA-COMPRESOR	36351	2011	
BANDA-ALT-VENT	K081047	BANDA-VENT	K100894
TENSOR-ALT-VENT	38556	MANGUERA INFERIOR-RAD. A TUBO	21302
TAPÓN DE RADIADOR-(10 LBS) SIN PALANCA	31567	POLEA-ALT-VENT	36164
MANGUERA INFERIOR-	23793	TENSOR-ALT-VENT	38634
MANGUERA SUPERIOR-	23795	TAPÓN DE RADIADOR-(10 LBS) SIN PALANCA	31567
2011		BOMBA DE AGUA-	43325HD
POLEA-COMPRESOR	36351	MANGUERA SUPERIOR-	23794
BANDA-ALT-VENT	K081047	2010	
TENSOR-ALT-VENT	38556	BANDA-VENT	K100894
TAPÓN DE RADIADOR-(10 LBS) SIN PALANCA	31567	MANGUERA INFERIOR-RAD. A TUBO	21302
MANGUERA INFERIOR-	23793	POLEA-ALT-VENT	36164
MANGUERA SUPERIOR-	23795	TENSOR-ALT-VENT	38634
2010		TAPÓN DE RADIADOR-(10 LBS) SIN PALANCA	31567
POLEA-COMPRESOR	38006	BOMBA DE AGUA-	43325HD
TENSOR-COMPRESOR	38629	MANGUERA SUPERIOR-	23794
BANDA-ALT-VENT	K081065	2009	
TENSOR-ALT-VENT	38556	BANDA-VENT	K100894
TAPÓN DE RADIADOR-(10 LBS) SIN PALANCA	31567	MANGUERA INFERIOR-RAD. A TUBO	21302
BANDA-	K060696	POLEA-ALT-VENT	36164
MANGUERA INFERIOR-	23793	TENSOR-ALT-VENT	38634
MANGUERA SUPERIOR-	23795	TAPÓN DE RADIADOR-(10 LBS) SIN PALANCA	31567
2009		BOMBA DE AGUA-	43325HD
BANDA-ALT-VENT	K081065	MANGUERA SUPERIOR-	23794
TAPÓN DE RADIADOR-(10 LBS) SIN PALANCA	31567	2008	
2008		BANDA-VENT	K100894
MANGUERA SUPERIOR-RAD. A TUBO	21042	MANGUERA INFERIOR-RAD. A TUBO	21302
MANGUERA SUPERIOR-MOTOR A TUBO	21135	POLEA-ALT-VENT	36164
TENSOR-ALT-VENT-AA	38556	TENSOR-ALT-VENT	38634

DURASTAR 4400

INTERNATIONAL/NAVISTAR MAXXFORCE DT DIESEL

2013	
BANDA-VENT	K100877
POLEA-ALT-VENT	36164
TENSOR-ALT-VENT	38634
TAPÓN DE RADIADOR-(10 LBS) SIN PALANCA	31567
MANGUERA SUPERIOR-	23794
2012	
BANDA-VENT	K100877
POLEA-ALT-VENT	36164
TENSOR-ALT-VENT	38634
TAPÓN DE RADIADOR-(10 LBS) SIN PALANCA	31567
MANGUERA SUPERIOR-	23794

FE

INTERNATIONAL/NAVISTAR MAXXFORCE DT DIESEL

2012	
BANDA-ALT-VENT	K100745
TENSOR-ALT-VENT	38634
BOMBA DE AGUA-	43325HD
2011	
BANDA-ALT-VENT	K100745
TENSOR-ALT-VENT	38634
BOMBA DE AGUA-	43325HD
2010	



MASTER SERVICIO PESADO 2014

INTERNATIONAL/
NAVISTAR
FE

BANDA-ALT-VENT	K100745
TENSOR-ALT-VENT	38634
BOMBA DE AGUA-	43325HD
2009	
BANDA-VENT	K080774
TENSOR-VENT	38620
BOMBA DE AGUA-	43325HD

INTERNATIONAL/NAVISTAR DT466

2008	
TERMOSTATO-190°	33179
TERMOSTATO-190°	33957
TERMOSTATO-180°	33118

2007	
TERMOSTATO-190°	33179
TERMOSTATO-190°	33957
TERMOSTATO-180°	33118

2006	
TERMOSTATO-190°	33179
TERMOSTATO-190°	33957
TERMOSTATO-180°	33118

2005	
TENSOR-MOTOR	38620
BANDA-ALT-BA-VENT	K080774
TERMOSTATO-190°	33179
TERMOSTATO-190°	33957
TERMOSTATO-180°	33118

2004	
TENSOR-MOTOR	38514
BANDA-ALT-BA-VENT	K080726
TERMOSTATO-190°	33179
TERMOSTATO-190°	33957
TERMOSTATO-180°	33118
MANGUERA INFERIOR-	22783
POLEA DEL TENSOR-	36091

2003	
TENSOR-MOTOR	38514
BANDA-ALT-BA-VENT	K080726
TERMOSTATO-190°	33179
TERMOSTATO-190°	33957
TERMOSTATO-180°	33118
MANGUERA INFERIOR-	22783
POLEA DEL TENSOR-	36091

2002	
-------------	--

TENSOR-MOTOR	38514
BANDA-ALT-BA-VENT	K080726
TERMOSTATO-190°	33179
TERMOSTATO-190°	33957
TERMOSTATO-180°	33118
MANGUERA INFERIOR-	22783
POLEA DEL TENSOR-	36091

LONESTAR

CATERPILLAR C15 DIESEL

2009	
TERMOSTATO-190°	33579
TERMOSTATO-180°	33576
TERMOSTATO-180°	33578
TERMOSTATO-170°	33577

MXT

INTERNATIONAL/NAVISTAR VT365 DIESEL

2008	
MANGUERA INFERIOR-RAD. A TUBO	21891
BANDA-ALT-VENT-AA	K080816
2007	
MANGUERA INFERIOR-RAD. A TUBO	21891
BANDA-ALT-VENT-AA	K080816

PAYSTAR

INTERNATIONAL/NAVISTAR 530 DIESEL

1995	
MANGUERA SUPERIOR-TUBO A RAD.	CHARTER 2 1/2"
MANGUERA SUPERIOR-MOTOR A TUBO	CHARTER 2 1/4"
MANGUERA INFERIOR-	CHARTER 2 1/2"

CUMMINS N14 DIESEL

2000	
MANGUERA INFERIOR-TUBO A RAD.	20748
BANDA-TOMA DE FUERZA-VENT	PQ28522
BANDA-TOMA DE FUERZA-BA	K060408
BANDA-TOMA DE FUERZA-AA	8405 GS
MANGUERA SUPERIOR-MOTOR A TUBO	CHARTER 2 1/4"
BANDA-ALT	PQ17450
MANGUERA INFERIOR-	CHARTER 2 1/4"
1999	
MANGUERA INFERIOR-TUBO A RAD.	20748
BANDA-TOMA DE FUERZA-VENT	PQ28522
BANDA-TOMA DE FUERZA-BA	K060408
MANGUERA SUPERIOR-MOTOR A TUBO	CHARTER 2 1/4"
BANDA-ALT	PQ17450



MASTER SERVICIO PESADO 2014

INTERNATIONAL/
NAVISTAR
PAYSTAR

MANGUERA INFERIOR-	CHARTER 2 1/4"	BANDA-VENT	PQ28423
1998		BANDA-VENT	PQ28492
BANDA-VENT	PQ28522	BANDA-VENT	PQ28514
MANGUERA SUPERIOR-MOTOR A TUBO	CHARTER 2 1/2"	BANDA-VENT	TR24530
BANDA-BA	K060425	MANGUERA SUPERIOR-TUBO A RAD.	CHARTER 2 1/2"
BANDA-BA	K060435	MANGUERA SUPERIOR-MOTOR A TUBO	CHARTER 2 1/4"
BANDA-ALT	2/9447PB	BANDA-BA	K040430
BANDA-AA	PQ17430	BANDA-BA	K040445
MANGUERA INFERIOR-	CHARTER 2 1/2"	BANDA-BA	K060435
1997		BANDA-ALT	2/9447PB
BANDA-VENT	PQ28522	BANDA-ALT	PQ17450
MANGUERA SUPERIOR-MOTOR A TUBO	CHARTER 2 1/2"	BANDA-AA	8395 GS
BANDA-BA	K060425	BANDA-AA	PQ17430
BANDA-BA	K060435	MANGUERA DE PASO-	CHARTER 1"
BANDA-ALT	2/9447PB	MANGUERA INFERIOR-	CHARTER 2 1/2"
BANDA-AA	PQ17430	1992	
MANGUERA INFERIOR-	CHARTER 2 1/2"	BANDA-VENT	2/TR28492PB
1996		BANDA-VENT	PQ28423
BANDA-VENT	PQ28522	BANDA-VENT	PQ28492
MANGUERA SUPERIOR-MOTOR A TUBO	CHARTER 2 1/2"	BANDA-VENT	PQ28514
BANDA-BA	K060425	BANDA-VENT	TR24530
BANDA-BA	K060435	MANGUERA SUPERIOR-TUBO A RAD.	CHARTER 2 1/2"
BANDA-ALT	2/9447PB	MANGUERA SUPERIOR-MOTOR A TUBO	CHARTER 2 1/4"
BANDA-AA	PQ17430	BANDA-BA	K040430
MANGUERA INFERIOR-	CHARTER 2 1/2"	BANDA-BA	K040445
1995		BANDA-BA	K060435
BANDA-VENT	PQ28522	BANDA-ALT	2/9447PB
MANGUERA SUPERIOR-MOTOR A TUBO	CHARTER 2 1/2"	BANDA-ALT	PQ17450
BANDA-BA	K060425	BANDA-AA	8395 GS
BANDA-BA	K060435	BANDA-AA	PQ17430
BANDA-ALT	2/9447PB	MANGUERA DE PASO-	CHARTER 1"
BANDA-AA	PQ17430	MANGUERA INFERIOR-	CHARTER 2 1/2"
MANGUERA INFERIOR-	CHARTER 2 1/2"	CUMMINS M11 DIESEL	
1994		2000	
BANDA-VENT	PQ28522	BANDA-VENT	K080645
MANGUERA SUPERIOR-MOTOR A TUBO	CHARTER 2 1/2"	MANGUERA INFERIOR-TUBO A RAD.	20748
BANDA-BA	K060425	BANDA-TOMA DE FUERZA-ALT	K050336
BANDA-BA	K060435	BANDA-TOMA DE FUERZA-AA	TR22525
BANDA-ALT	2/9447PB	MANGUERA SUPERIOR-MOTOR A TUBO	CHARTER 2 1/4"
BANDA-AA	PQ17430	MANGUERA INFERIOR-	CHARTER 2 1/4"
MANGUERA INFERIOR-	CHARTER 2 1/2"	1999	
1993		BANDA-VENT	K080605
BANDA-VENT	2/TR28492PB	MANGUERA INFERIOR-TUBO A RAD.	21135

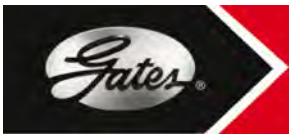

MASTER SERVICIO PESADO 2014

INTERNATIONAL/
NAVISTAR
PAYSTAR

BANDA-TOMA DE FUERZA-ALT	K050336	1994	
MANGUERA SUPERIOR-MOTOR A TUBO	CHARTER 2 1/2"	BANDA-VENT	K080585
MANGUERA INFERIOR-	CHARTER 2 1/2"	BANDA-VENT	K080605
1998		BANDA-VENT	K080615
BANDA-VENT	K080605	MANGUERA SUPERIOR-TUBO A RAD.	CHARTER 2 1/4"
MANGUERA SUPERIOR-TUBO A RAD.	CHARTER 2 1/2"	MANGUERA SUPERIOR-MOTOR A TUBO	CHARTER 2 1/4"
MANGUERA SUPERIOR-MOTOR A TUBO	CHARTER 2 1/2"	BANDA-ALT	K050336
BANDA-ALT	K050336	MANGUERA INFERIOR-	CHARTER 2 1/2"
BANDA-AA	TR22525	1993	
MANGUERA INFERIOR-	CHARTER 2 1/2"	BANDA-VENT	K080585
1997		BANDA-VENT	K080605
BANDA-VENT	K080605	BANDA-VENT	K080615
MANGUERA SUPERIOR-TUBO A RAD.	CHARTER 2 1/2"	MANGUERA SUPERIOR-TUBO A RAD.	CHARTER 2 1/2"
MANGUERA SUPERIOR-MOTOR A TUBO	CHARTER 2 1/2"	MANGUERA SUPERIOR-MOTOR A TUBO	CHARTER 2 1/4"
BANDA-ALT	K050336	BANDA-ALT	K050336
BANDA-AA	TR22525	MANGUERA DE PASO-	CHARTER 1"
MANGUERA INFERIOR-	CHARTER 2 1/2"	MANGUERA INFERIOR-	CHARTER 2 1/2"
1996		1992	
BANDA-VENT	K080605	BANDA-VENT	K080585
MANGUERA SUPERIOR-TUBO A RAD.	CHARTER 2 1/2"	BANDA-VENT	K080605
MANGUERA SUPERIOR-MOTOR A TUBO	CHARTER 2 1/2"	BANDA-VENT	K080615
BANDA-ALT	K050336	MANGUERA SUPERIOR-TUBO A RAD.	CHARTER 2 1/2"
BANDA-AA	TR22525	MANGUERA SUPERIOR-MOTOR A TUBO	CHARTER 2 1/4"
MANGUERA INFERIOR-	CHARTER 2 1/2"	BANDA-ALT	K050336
CUMMINS L10 DIESEL		MANGUERA DE PASO-	CHARTER 1"
1997		MANGUERA INFERIOR-	CHARTER 2 1/2"
BANDA-VENT	K080605	1991	
MANGUERA SUPERIOR-TUBO A RAD.	CHARTER 2 1/4"	BANDA-VENT	K080585
MANGUERA SUPERIOR-MOTOR A TUBO	CHARTER 2 1/4"	BANDA-VENT	K080605
BANDA-ALT	K050336	BANDA-VENT	K080615
MANGUERA INFERIOR-	CHARTER 2 1/2"	BANDA-VENT	K080630
1996		BANDA-ALT	K050336
BANDA-VENT	K080605	BANDA-AA	PQ17530
MANGUERA SUPERIOR-TUBO A RAD.	CHARTER 2 1/4"	1990	
MANGUERA SUPERIOR-MOTOR A TUBO	CHARTER 2 1/4"	BANDA-VENT	K080585
BANDA-ALT	K050336	BANDA-VENT	K080605
MANGUERA INFERIOR-	CHARTER 2 1/2"	BANDA-VENT	K080615
1995		BANDA-VENT	K080630
BANDA-VENT	K080605	BANDA-ALT	K050336
MANGUERA SUPERIOR-TUBO A RAD.	CHARTER 2 1/4"	BANDA-AA	PQ17530
MANGUERA SUPERIOR-MOTOR A TUBO	CHARTER 2 1/4"	CATERPILLAR C12 DIESEL	
BANDA-ALT	K050350	2000	
MANGUERA INFERIOR-	CHARTER 2 1/2"	BANDA-VENT-AA	PQ17450



MASTER SERVICIO PESADO 2014

INTERNATIONAL/
NAVISTAR
PAYSTAR

MANGUERA INFERIOR-TUBO A RAD.	21135	POLEA-MOTOR	36091
MANGUERA SUPERIOR-MOTOR A TUBO	CHARTER 2 1/2"	POLEA-MOTOR	36093
BANDA-ALT-VENT	K080780	BANDA-ALT-VENT	K081088
MANGUERA INFERIOR-	CHARTER 2 1/2"	TENSOR-ALT-VENT	38569
CATERPILLAR C10 DIESEL		TERMOSTATO-190°	33579
2000		TERMOSTATO-180°	33576
BANDA-VENT-AA	PQ17450	TERMOSTATO-180°	33578
MANGUERA INFERIOR-TUBO A RAD.	21135	TERMOSTATO-170°	33577
MANGUERA SUPERIOR-MOTOR A TUBO	CHARTER 2 1/2"	CATERPILLAR C13 DIESEL	
BANDA-ALT-VENT	K080780	2008	
MANGUERA INFERIOR-	CHARTER 2 1/2"	TERMOSTATO-190°	33579
PAYSTAR 5500i		TERMOSTATO-180°	33576
CUMMINS ISX DIESEL		TERMOSTATO-180°	33578
2008		TERMOSTATO-170°	33577
BANDA-TOMA DE FUERZA-AA	K060637	PAYSTAR 5900i	
MANGUERA INFERIOR-RAD. A TUBO	21135	CUMMINS ISX DIESEL	
MANGUERA SUPERIOR-RAD. A TUBO	21115	2008	
MANGUERA SILICÓN-MOTOR A TUBO	SIH250363C	BANDA-TOMA DE FUERZA-AA	K060637
MANGUERA SUPERIOR-MOTOR A TUBO	21135	MANGUERA INFERIOR-RAD. A TUBO	21135
BANDA-ALT-VENT	K120964	MANGUERA SUPERIOR-RAD. A TUBO	21891
TENSOR-ALT-VENT	38587	MANGUERA SILICÓN-MOTOR A TUBO	SIH250363C
CATERPILLAR C15 DIESEL		MANGUERA SUPERIOR-MOTOR A TUBO	21135
2008		BANDA-ALT-VENT	K120964
TERMOSTATO-190°	33579	TENSOR-ALT-VENT	38587
TERMOSTATO-180°	33576	CATERPILLAR C15 DIESEL	
TERMOSTATO-180°	33578	2008	
TERMOSTATO-170°	33577	TERMOSTATO-190°	33579
CATERPILLAR C13 DIESEL		TERMOSTATO-180°	33576
2008		TERMOSTATO-180°	33578
TERMOSTATO-190°	33579	TERMOSTATO-170°	33577
TERMOSTATO-180°	33576	CATERPILLAR C13 DIESEL	
TERMOSTATO-180°	33578	2008	
TERMOSTATO-170°	33577	TERMOSTATO-190°	33579
PAYSTAR 5600i		TERMOSTATO-180°	33576
CATERPILLAR C15 DIESEL		TERMOSTATO-180°	33578
2008		TERMOSTATO-170°	33577
BANDA-VENT-AA	K060555	PROSTAR SERIES	
POLEA DEL TENSOR-VENT-AA	36091	INTERNATIONAL/NAVISTAR MAXXFORCE 13 DIESEL	
TENSOR-VENT-AA	38511	2010	
MANGUERA INFERIOR-RAD. A TUBO	21135	MANGUERA INFERIOR-RAD. A TUBO	21891
MANGUERA SUPERIOR-RAD. A TUBO	21891	MANGUERA SUPERIOR-RAD. A TUBO	21135
MANGUERA SILICÓN-MOTOR A TUBO	SIH300363C	MANGUERA SILICÓN-MOTOR A TUBO	SIH250363C
MANGUERA SUPERIOR-MOTOR A TUBO	21135	MANGUERA SUPERIOR-MOTOR A TUBO	21891



MASTER SERVICIO PESADO 2014

INTERNATIONAL/
NAVISTAR
PROSTAR SERIES

BANDA-ALT-AA	K080794	POLEA-BA-AA	36223
TAPÓN DE RADIADOR-(10 LBS) SIN PALANCA	31567	TENSOR-BA-AA	38610
2009		BANDA-ALT-VENT	K120870
MANGUERA INFERIOR-RAD. A TUBO	21891	TERMOSTATO-190°	34149
MANGUERA SUPERIOR-RAD. A TUBO	21135	TERMOSTATO-180°	34146
MANGUERA SILICÓN-MOTOR A TUBO	SIH250363C	TERMOSTATO-180°	34148
MANGUERA SUPERIOR-MOTOR A TUBO	21891	TAPÓN DE RADIADOR-(10 LBS) SIN PALANCA	31567
BANDA-ALT-AA	K080794	2009	
TAPÓN DE RADIADOR-(10 LBS) SIN PALANCA	31567	MANGUERA SILICÓN-RAD. A TUBO	SIH250363C
2008		MANGUERA SILICÓN-MOTOR A TUBO	SIH250363C
MANGUERA INFERIOR-RAD. A TUBO	21891	BANDA-BA-AA	K060637
MANGUERA SUPERIOR-RAD. A TUBO	21135	POLEA-BA-AA	36223
MANGUERA SILICÓN-MOTOR A TUBO	SIH250363C	TENSOR-BA-AA	38610
MANGUERA SUPERIOR-MOTOR A TUBO	21891	BANDA-ALT-VENT	K120870
BANDA-ALT-AA	K080794	TERMOSTATO-190°	34149
TAPÓN DE RADIADOR-(10 LBS) SIN PALANCA	31567	TERMOSTATO-180°	34146
CUMMINS ISX DIESEL		TERMOSTATO-180°	34148
2012		TAPÓN DE RADIADOR-(10 LBS) SIN PALANCA	31567
MANGUERA SILICÓN-RAD. A TUBO	SIH250363C	2008	
MANGUERA SILICÓN-MOTOR A TUBO	SIH250363C	BANDA-TOMA DE FUERZA-AA	K060637
BANDA-BA-AA	K060637	POLEA-TOMA DE FUERZA-AA	36223
POLEA-BA-AA	36223	TENSOR-TOMA DE FUERZA-AA	38610
TENSOR-BA-AA	38610	MANGUERA SILICÓN-RAD. A TUBO	SIH250363C
BANDA-ALT-VENT	K120870	MANGUERA SILICÓN-MOTOR A TUBO	SIH250363C
TERMOSTATO-190°	34149	BANDA-ALT-VENT	K080708
TERMOSTATO-180°	34146	POLEA-ALT-VENT	36308
TERMOSTATO-180°	34148	TENSOR-ALT-VENT	38521
TAPÓN DE RADIADOR-(10 LBS) SIN PALANCA	31567	TERMOSTATO-190°	34149
2011		TERMOSTATO-180°	34146
MANGUERA SILICÓN-RAD. A TUBO	SIH250363C	TERMOSTATO-180°	34148
MANGUERA SILICÓN-MOTOR A TUBO	SIH250363C	TAPÓN DE RADIADOR-(10 LBS) SIN PALANCA	31567
BANDA-BA-AA	K060637	2007	
POLEA-BA-AA	36223	BANDA-TOMA DE FUERZA-AA	K060637
TENSOR-BA-AA	38610	POLEA-TOMA DE FUERZA-AA	36223
BANDA-ALT-VENT	K120870	TENSOR-TOMA DE FUERZA-AA	38610
TERMOSTATO-190°	34149	MANGUERA SILICÓN-RAD. A TUBO	SIH250363C
TERMOSTATO-180°	34146	MANGUERA SILICÓN-MOTOR A TUBO	SIH250363C
TERMOSTATO-180°	34148	BANDA-ALT-VENT	K080708
TAPÓN DE RADIADOR-(10 LBS) SIN PALANCA	31567	POLEA-ALT-VENT	36308
2010		TENSOR-ALT-VENT	38521
MANGUERA SILICÓN-RAD. A TUBO	SIH250363C	TERMOSTATO-190°	34149
MANGUERA SILICÓN-MOTOR A TUBO	SIH250363C	TERMOSTATO-180°	34146
BANDA-BA-AA	K060637	TERMOSTATO-180°	34148



MASTER SERVICIO PESADO 2014

INTERNATIONAL/
NAVISTAR
PROSTAR SERIES

TAPÓN DE RADIADOR-(10 LBS) SIN PALANCA

31567

CATERPILLAR C15 DIESEL

2008

TERMOSTATO-190°

33579

TERMOSTATO-180°

33576

TERMOSTATO-180°

33578

TERMOSTATO-170°

33577

CATERPILLAR C13 DIESEL

2008

TERMOSTATO-190°

33579

TERMOSTATO-180°

33576

TERMOSTATO-180°

33578

TERMOSTATO-170°

33577

2007

TERMOSTATO-190°

33579

TERMOSTATO-180°

33576

TERMOSTATO-180°

33578

TERMOSTATO-170°

33577

RE

INTERNATIONAL/NAVISTAR T444 DIESEL

2004

TERMOSTATO-195°

33967

2003

TERMOSTATO-195°

33967

2002

TERMOSTATO-195°

33967

2001

TERMOSTATO-195°

33967

2000

TERMOSTATO-195°

33967

1999

TERMOSTATO-195°

33967

1998

TERMOSTATO-195°

33967

INTERNATIONAL/NAVISTAR MAXXFORCE DT DIESEL

2012

TENSOR-SERPENTIN

38634

BANDA-MOTOR

K101091

TENSOR-ALT-BA-VENT C/ALT 120A

38634

BANDA-ALT-BA-VENT

K101091

TERMOSTATO-190°

33179

TERMOSTATO-190°

33957

TERMOSTATO-180°

33118

BOMBA DE AGUA-

43325HD

2011

TENSOR-SERPENTIN

38634

BANDA-MOTOR

K101091

TENSOR-ALT-BA-VENT C/ALT 120A

38634

BANDA-ALT-BA-VENT

K101091

TERMOSTATO-190°

33179

TERMOSTATO-190°

33957

TERMOSTATO-180°

33118

BOMBA DE AGUA-

43325HD

2010

TENSOR-SERPENTIN

38634

BANDA-MOTOR

K101091

TENSOR-ALT-BA-VENT C/ALT 120A

38634

BANDA-ALT-BA-VENT

K101091

TERMOSTATO-190°

33179

TERMOSTATO-190°

33957

TERMOSTATO-180°

33118

BOMBA DE AGUA-

43325HD

2009

TENSOR-SERPENTIN

38634

BANDA-MOTOR

K101091

TENSOR-ALT-BA-VENT C/ALT 120A

38634

BANDA-ALT-BA-VENT

K101091

TERMOSTATO-190°

33179

TERMOSTATO-190°

33957

TERMOSTATO-180°

33118

BOMBA DE AGUA-

43325HD

2008

TENSOR-ALT-BA-VENT C/ALT 120A

38634

BANDA-ALT-BA-VENT

K101091

TERMOSTATO-190°

33179

TERMOSTATO-190°

33957

TERMOSTATO-180°

33118

BOMBA DE AGUA-

43325HD

INTERNATIONAL/NAVISTAR DT466

2008

BANDA-ALT-BA-VENT C/ALT 120A

K080830

TENSOR-ALT-BA-VENT C/ALT 120A

38620

TERMOSTATO-190°

33179

TERMOSTATO-190°

33957

TERMOSTATO-180°

33118

2007

BANDA-ALT-BA-VENT C/ALT 120A

K080830



MASTER SERVICIO PESADO 2014

INTERNATIONAL/
NAVISTAR
RE

TENSOR-ALT-BA-VENT C/ALT 120A	38620	TERMOSTATO-190°	33179
TERMOSTATO-190°	33179	TERMOSTATO-190°	33957
TERMOSTATO-190°	33957	TERMOSTATO-180°	33118
TERMOSTATO-180°	33118	1999	
2006		BANDA-ALT-BA-VENT	K080842
BANDA-ALT-BA-VENT C/ALT 120A	K080830	TENSOR-ALT-BA-VENT	38620
TENSOR-ALT-BA-VENT	38620	TERMOSTATO-190°	33179
TERMOSTATO-190°	33179	TERMOSTATO-190°	33957
TERMOSTATO-190°	33957	TERMOSTATO-180°	33118
TERMOSTATO-180°	33118	1998	
2005		BANDA-ALT-BA-VENT	K080842
BANDA-ALT-BA-VENT	K080842	TENSOR-ALT-BA-VENT	38620
TENSOR-ALT-BA-VENT	38620	TERMOSTATO-190°	33179
TERMOSTATO-190°	33179	TERMOSTATO-190°	33957
TERMOSTATO-190°	33957	TERMOSTATO-180°	33118
TERMOSTATO-180°	33118	INTERNATIONAL/NAVISTAR 530 DIESEL	
2004		2004	
BANDA-ALT-BA-VENT	K080842	BANDA-ALT-VENT	K080765
TENSOR-ALT-BA-VENT	38620	POLEA-ALT-VENT	36091
TERMOSTATO-190°	33179	TENSOR-ALT-VENT	38514
TERMOSTATO-190°	33957	2003	
TERMOSTATO-180°	33118	BANDA-ALT-VENT	K080765
2003		POLEA-ALT-VENT	36091
BANDA-ALT-BA-VENT	K080842	TENSOR-ALT-VENT	38514
TENSOR-ALT-BA-VENT	38620	2002	
TERMOSTATO-190°	33179	POLEA-ALT-VENT	36091
TERMOSTATO-190°	33957	TENSOR-ALT-VENT	38514
TERMOSTATO-180°	33118	2001	
2002		BANDA-ALT-VENT	K080760
BANDA-ALT-BA-VENT	K080842	POLEA-ALT-VENT	36091
TENSOR-ALT-BA-VENT	38620	TENSOR-ALT-VENT	38514
TERMOSTATO-190°	33179	2000	
TERMOSTATO-190°	33957	BANDA-ALT-VENT	K080760
TERMOSTATO-180°	33118	POLEA-ALT-VENT	36091
2001		TENSOR-ALT-VENT	38514
BANDA-ALT-BA-VENT	K080842	1999	
TENSOR-ALT-BA-VENT	38620	BANDA-ALT-VENT	K080760
TERMOSTATO-190°	33179	POLEA-ALT-VENT	36091
TERMOSTATO-190°	33957	TENSOR-ALT-VENT	38514
TERMOSTATO-180°	33118	1998	
2000		BANDA-ALT-VENT	K080760
BANDA-ALT-BA-VENT	K080842	POLEA-ALT-VENT	36091
TENSOR-ALT-BA-VENT	38620	TENSOR-ALT-VENT	38514



MASTER SERVICIO PESADO 2014

INTERNATIONAL/
NAVISTAR
TRANSTAR 8500

TRANSTAR 8500

CATERPILLAR C13 DIESEL

2008

POLEA-MOTOR	36093
TERMOSTATO-190°	33579
TERMOSTATO-180°	33576
TERMOSTATO-180°	33578
TERMOSTATO-170°	33577

TRANSTAR 8600

CUMMINS ISM DIESEL

2008

BANDA-TOMA DE FUERZA-AA	K060516
TENSOR-TOMA DE FUERZA-AA	38505
MANGUERA INFERIOR-RAD. A TUBO	21135
MANGUERA INFERIOR-MOTOR A TUBO	21891
MANGUERA SUPERIOR-MOTOR A TUBO	21135
BANDA-ALT-VENT	K080694
TENSOR-ALT-VENT	38622
POLEA DEL TENSOR-	36091

CATERPILLAR C13 DIESEL

2008

POLEA-MOTOR	36093
TERMOSTATO-190°	33579
TERMOSTATO-180°	33576
TERMOSTATO-180°	33578
TERMOSTATO-170°	33577

WORKSTAR 7300

INTERNATIONAL/NAVISTAR MAXXFORCE DT DIESEL

2009

MANGUERA INFERIOR-TUBO A RAD.	21135
MANGUERA INFERIOR-MOTOR A TUBO	21891
MANGUERA SUPERIOR-MOTOR A TUBO	21135
BANDA-ALT-VENT-AA	K101015
TENSOR-ALT-VENT-AA	38634
TAPÓN DE RADIADOR-(10 LBS) SIN PALANCA	31567
BOMBA DE AGUA-	43325HD

2008

MANGUERA INFERIOR-TUBO A RAD.	21135
MANGUERA INFERIOR-MOTOR A TUBO	21891
MANGUERA SUPERIOR-MOTOR A TUBO	21135
BANDA-ALT-VENT-AA	K101015
TENSOR-ALT-VENT-AA	38634

TAPÓN DE RADIADOR-(10 LBS) SIN PALANCA

31567

BOMBA DE AGUA-

43325HD

WORKSTAR 7400

INTERNATIONAL/NAVISTAR MAXXFORCE 9 DIESEL

2012

BANDA-VENT	K080855
POLEA-VENT	36164
MANGUERA SUPERIOR-RAD. A TUBO	21135
MANGUERA SILICÓN-MOTOR A TUBO	SIH250363C
MANGUERA SILICÓN-MOTOR A ENFRIADOR	SIH250363C
MANGUERA SILICÓN-ENFRIADOR A TUBO	SIH250363C
TENSOR-ALT-VENT-AA	38634
BANDA-ALT-BA-AA	K100822
POLEA-ALT-BA-AA	36164
TAPÓN DE RADIADOR-(10 LBS) SIN PALANCA	31567
MANGUERA INFERIOR-	21135

2011

BANDA-VENT	K080855
POLEA-VENT	36164
MANGUERA SUPERIOR-RAD. A TUBO	21135
MANGUERA SILICÓN-MOTOR A TUBO	SIH250363C
MANGUERA SILICÓN-MOTOR A ENFRIADOR	SIH250363C
MANGUERA SILICÓN-ENFRIADOR A TUBO	SIH250363C
TENSOR-ALT-VENT-AA	38634
BANDA-ALT-BA-AA	K100822
POLEA-ALT-BA-AA	36164
TAPÓN DE RADIADOR-(10 LBS) SIN PALANCA	31567
MANGUERA INFERIOR-	21135

2010

BANDA-VENT	K080855
POLEA-VENT	36164
MANGUERA SUPERIOR-RAD. A TUBO	21135
MANGUERA SILICÓN-MOTOR A TUBO	SIH250363C
MANGUERA SILICÓN-MOTOR A ENFRIADOR	SIH250363C
MANGUERA SILICÓN-ENFRIADOR A TUBO	SIH250363C
TENSOR-ALT-VENT-AA	38634
BANDA-ALT-BA-AA	K100822
POLEA-ALT-BA-AA	36164
TAPÓN DE RADIADOR-(10 LBS) SIN PALANCA	31567
MANGUERA INFERIOR-	21135

2009

MANGUERA INFERIOR-RAD. A TUBO	21891
MANGUERA SUPERIOR-RAD. A TUBO	21135



MASTER SERVICIO PESADO 2014

INTERNATIONAL/
NAVISTAR
WORKSTAR 7400

MANGUERA SILICÓN-MOTOR A TUBO	SIH250363C	TAPÓN DE RADIADOR-(10 LBS) SIN PALANCA	31567
MANGUERA SILICÓN-MOTOR A ENFRIADOR	SIH250363C	2009	
MANGUERA SILICÓN-ENFRIADOR A TUBO	SIH250363C	MANGUERA INFERIOR-RAD. A TUBO	21891
BANDA-ALT-VENT-AA	K100983	MANGUERA SUPERIOR-RAD. A TUBO	21135
TENSOR-ALT-VENT-AA	38634	BANDA-ALT-VENT	K080816
BANDA-ALT-VENT	K100818	POLEA-ALT-VENT	36308
TAPÓN DE RADIADOR-(10 LBS) SIN PALANCA	31567	TENSOR-ALT-VENT	38622
2008		BANDA-AA	K060516
MANGUERA INFERIOR-RAD. A TUBO	21891	POLEA-AA	36225
MANGUERA SUPERIOR-RAD. A TUBO	21135	TENSOR-AA	38505
MANGUERA SILICÓN-MOTOR A TUBO	SIH250363C	TERMOSTATO-190°	34149
MANGUERA SILICÓN-MOTOR A ENFRIADOR	SIH250363C	TERMOSTATO-180°	34146
MANGUERA SILICÓN-ENFRIADOR A TUBO	SIH250363C	TERMOSTATO-180°	34148
BANDA-ALT-VENT-AA	K100983	TAPÓN DE RADIADOR-(10 LBS) SIN PALANCA	31567
TENSOR-ALT-VENT-AA	38634	MANGUERA INFERIOR-	24240
BANDA-ALT-VENT	K100818	MANGUERA SUPERIOR-	24240
TAPÓN DE RADIADOR-(10 LBS) SIN PALANCA	31567	2008	
INTERNATIONAL/NAVISTAR MAXXFORCE 10 DIESEL		BANDA-TOMA DE FUERZA-AA	K060516
2008		TENSOR-TOMA DE FUERZA-AA	38505
MANGUERA INFERIOR-RAD. A TUBO	21891	MANGUERA INFERIOR-RAD. A TUBO	21891
MANGUERA INFERIOR-MOTOR A ENFRIADOR	21891	MANGUERA SUPERIOR-RAD. A TUBO	21135
MANGUERA INFERIOR-ENFRIADOR A TUBO	21891	MANGUERA SILICÓN-MOTOR A TUBO	SIH250363C
MANGUERA SUPERIOR-	21135	MANGUERA SILICÓN-ENFRIADOR A TUBO	SIH250363C
WORKSTAR 7500		BANDA-ALT-VENT	K080806
INTERNATIONAL/NAVISTAR MAXXFORCE 10 DIESEL		POLEA-ALT-VENT	36308
2008		TENSOR-ALT-VENT	38622
MANGUERA INFERIOR-RAD. A TUBO	21135	BANDA-AA	K060516
MANGUERA SUPERIOR-RAD. A TUBO	21135	POLEA-AA	36225
MANGUERA INFERIOR-MOTOR A TUBO	21891	TENSOR-AA	38505
MANGUERA SUPERIOR-MOTOR A TUBO	24436	TERMOSTATO-190°	34149
WORKSTAR 7600		TERMOSTATO-180°	34146
CUMMINS ISM DIESEL		TERMOSTATO-180°	34148
2010		TAPÓN DE RADIADOR-(10 LBS) SIN PALANCA	31567
BANDA-ALT-VENT	K080816	MANGUERA INFERIOR-	24240
POLEA-ALT-VENT	36308	MANGUERA SUPERIOR-	24240
TENSOR-ALT-VENT	38622	POLEA DEL TENSOR-	36091
BANDA-AA	K060516	CATERPILLAR C13 DIESEL	
POLEA-AA	36225	2008	
TENSOR-AA	38505	TERMOSTATO-190°	33579
TERMOSTATO-190°	34149	TERMOSTATO-180°	33576
TERMOSTATO-180°	34146	TERMOSTATO-180°	33578
TERMOSTATO-180°	34148	TERMOSTATO-170°	33577
		CATERPILLAR C11 DIESEL	



MASTER SERVICIO PESADO 2014

INTERNATIONAL/
NAVISTAR
WORKSTAR 7600

2010

TERMOSTATO-190°	33579
TERMOSTATO-180°	33576
TERMOSTATO-180°	33578
TERMOSTATO-170°	33577

2009

TERMOSTATO-190°	33579
TERMOSTATO-180°	33576
TERMOSTATO-180°	33578
TERMOSTATO-170°	33577

2008

TERMOSTATO-190°	33579
TERMOSTATO-180°	33576
TERMOSTATO-180°	33578
TERMOSTATO-170°	33577

WORKSTAR 7700

CATERPILLAR C13 DIESEL

2008

POLEA-MOTOR	36093
TERMOSTATO-190°	33579
TERMOSTATO-180°	33576
TERMOSTATO-180°	33578
TERMOSTATO-170°	33577

CATERPILLAR C11 DIESEL

2008

TERMOSTATO-190°	33579
TERMOSTATO-180°	33576
TERMOSTATO-180°	33578
TERMOSTATO-170°	33577

IRIZAR



INTERCENTURY

906

BANDA-VENT-TEMPLADOR	AX54
BANDA-MOTOR	AX65
BANDA-COMPRESOR	BX83
BANDA-BA	K080570
BANDA-ALT-COMPRESOR	AX42

2005

BANDA-VENT-TEMPLADOR	AX54
----------------------	------

BANDA-MOTOR AX65

BANDA-COMPRESOR BX83

BANDA-BA K080570

BANDA-ALT-COMPRESOR AX42

2004

BANDA-VENT-TEMPLADOR AX54

BANDA-MOTOR AX65

BANDA-COMPRESOR BX83

BANDA-BA K080570

BANDA-ALT-COMPRESOR AX42

2003

BANDA-VENT AX54

BANDA-MOTOR AX65

BANDA-COMPRESOR BX83

BANDA-BA K080570

BANDA-ALT-COMPRESOR AX42

MAN A-82

MAN A-82

2010

BANDA-ALT-BA 3VX650

BANDA-ALT-BA 6641 GS

2009

BANDA-ALT-BA 3VX650

BANDA-ALT-BA 6641 GS

2008

BANDA-ALT-BA 3VX650

BANDA-ALT-BA 6641 GS

2007

BANDA-ALT-BA 3VX650

BANDA-ALT-BA 6641 GS

2006

BANDA-ALT-BA 3VX650

BANDA-ALT-BA 6641 GS

2005

BANDA-ALT-BA 3VX650

BANDA-ALT-BA 6641 GS

MAN AUTOMATICO

MAN PANORAMICO

2010

BANDA-ALT1-ALT2-BA K080733

BANDA-ALT K050605

2009

BANDA-ALT1-ALT2-BA K080733



BANDA-ALT	K050605
2008	
BANDA-ALT1-ALT2-BA	K080733
BANDA-ALT	K050605
2007	
BANDA-ALT1-ALT2-BA	K080733
BANDA-ALT	K050605

MAN PANORAMICO

MAN PANORAMICO

2010	
BANDA-COMPRESOR	K100922
BANDA-ALT1-ALT2-BA	K080733
BANDA-ALT	K050605
2009	
BANDA-COMPRESOR	K100922
BANDA-ALT1-ALT2-BA	K080733
BANDA-ALT	K050605
2008	
BANDA-COMPRESOR	K100922
BANDA-ALT1-ALT2-BA	K080733
BANDA-ALT	K050605
2007	
BANDA-COMPRESOR	K100922
BANDA-ALT1-ALT2-BA	K080733
BANDA-ALT	K050605

MAN R-33

MAN R-33

2010	
BANDA-COMPRESOR	BX75
BANDA-ALT-COMPRESOR	AX37
BANDA-ALT-BA	3VX650
2009	
BANDA-COMPRESOR	BX75
BANDA-ALT-COMPRESOR	AX37
BANDA-ALT-BA	3VX650
2008	
BANDA-COMPRESOR	BX75
BANDA-ALT-COMPRESOR	AX37
BANDA-ALT-BA	3VX650
2007	
BANDA-COMPRESOR	BX75
BANDA-ALT-COMPRESOR	AX37
BANDA-ALT-BA	3VX650

2006	
BANDA-COMPRESOR	BX75
BANDA-ALT-COMPRESOR	AX37
BANDA-ALT-BA	3VX650

ISUZU



ELF 200

4JJ1-TC

2014	
TAPÓN DE GASOLINA-SIN LLAVE	31843
TAPÓN DE GASOLINA-CON LLAVE	31844
BANDA-ALT	K070404
TERMOSTATO-188° LADO PILOTO	33964
TERMOSTATO-185° LADO COPILOTO	33965
TAPÓN DE RADIADOR-(13 LBS) SIN PALANCA	31333
TAPÓN DE ACEITE-	31117
2013	
TAPÓN DE GASOLINA-SIN LLAVE	31843
TAPÓN DE GASOLINA-CON LLAVE	31844
BANDA-ALT	K070404
TERMOSTATO-188° LADO PILOTO	33964
TERMOSTATO-185° LADO COPILOTO	33965
TAPÓN DE RADIADOR-(13 LBS) SIN PALANCA	31333
TAPÓN DE ACEITE-	31117
2012	
TAPÓN DE GASOLINA-SIN LLAVE	31843
TAPÓN DE GASOLINA-CON LLAVE	31844
BANDA-ALT	K070404
TERMOSTATO-188° LADO PILOTO	33964
TERMOSTATO-185° LADO COPILOTO	33965
TAPÓN DE RADIADOR-(13 LBS) SIN PALANCA	31333
TAPÓN DE ACEITE-	31117
2011	
TAPÓN DE GASOLINA-SIN LLAVE	31843
TAPÓN DE GASOLINA-CON LLAVE	31844
BANDA-ALT	K070404
TERMOSTATO-188° LADO PILOTO	33964
TERMOSTATO-185° LADO COPILOTO	33965
TAPÓN DE RADIADOR-(13 LBS) SIN PALANCA	31333
TAPÓN DE ACEITE-	31117
2010	



MASTER SERVICIO PESADO 2014

ISUZU

ELF 200

TAPÓN DE GASOLINA-SIN LLAVE	31843	BANDA-S/COMPRESOR	K070390
BANDA-MOTOR	K070404	TAPÓN DE GASOLINA-CON LLAVE	31844
TAPÓN DE GASOLINA-CON LLAVE	31844	BANDA-COMPRESOR	K070406
TERMOSTATO-188° LADO PILOTO	33964	TERMOSTATO-188° LADO PILOTO	33964
TERMOSTATO-185° LADO COPILOTO	33965	TERMOSTATO-185° LADO COPILOTO	33965
TAPÓN DE RADIADOR-(13 LBS) SIN PALANCA	31333	TAPÓN DE RADIADOR-(13 LBS) SIN PALANCA	31333
TAPÓN DE ACEITE-	31117	TAPÓN DE ACEITE-	31117

2009

TAPÓN DE GASOLINA-SIN LLAVE	31843
BANDA-MOTOR	K070404
TAPÓN DE GASOLINA-CON LLAVE	31844
TERMOSTATO-188° LADO PILOTO	33964
TERMOSTATO-185° LADO COPILOTO	33965
TAPÓN DE RADIADOR-(13 LBS) SIN PALANCA	31333
TAPÓN DE ACEITE-	31117

2010

TAPÓN DE GASOLINA-SIN LLAVE	31843
BANDA-S/COMPRESOR	K070390
TAPÓN DE GASOLINA-CON LLAVE	31844
BANDA-COMPRESOR	K070406
TERMOSTATO-188° LADO PILOTO	33964
TERMOSTATO-185° LADO COPILOTO	33965
TAPÓN DE RADIADOR-(13 LBS) SIN PALANCA	31333
TAPÓN DE ACEITE-	31117

ELF 300

4JJ1-TC

2014

TAPÓN DE GASOLINA-SIN LLAVE	31843
TAPÓN DE GASOLINA-CON LLAVE	31844
BANDA-ALT	K070404
TERMOSTATO-188° LADO PILOTO	33964
TERMOSTATO-185° LADO COPILOTO	33965
TAPÓN DE RADIADOR-(13 LBS) SIN PALANCA	31333
TAPÓN DE ACEITE-	31117

2013

TAPÓN DE GASOLINA-SIN LLAVE	31843
TAPÓN DE GASOLINA-CON LLAVE	31844
BANDA-ALT	K070404
TERMOSTATO-188° LADO PILOTO	33964
TERMOSTATO-185° LADO COPILOTO	33965
TAPÓN DE RADIADOR-(13 LBS) SIN PALANCA	31333
TAPÓN DE ACEITE-	31117

2012

TAPÓN DE GASOLINA-SIN LLAVE	31843
TAPÓN DE GASOLINA-CON LLAVE	31844
BANDA-ALT	K070404
TERMOSTATO-188° LADO PILOTO	33964
TERMOSTATO-185° LADO COPILOTO	33965
TAPÓN DE RADIADOR-(13 LBS) SIN PALANCA	31333
TAPÓN DE ACEITE-	31117

2011

TAPÓN DE GASOLINA-SIN LLAVE	31843
-----------------------------	-------

2009

TAPÓN DE GASOLINA-SIN LLAVE	31843
BANDA-S/COMPRESOR	K070390
TAPÓN DE GASOLINA-CON LLAVE	31844
BANDA-COMPRESOR	K070406
TERMOSTATO-188° LADO PILOTO	33964
TERMOSTATO-185° LADO COPILOTO	33965
TAPÓN DE RADIADOR-(13 LBS) SIN PALANCA	31333
TAPÓN DE ACEITE-	31117

2008

TAPÓN DE GASOLINA-SIN LLAVE	31843
BANDA-S/COMPRESOR	K070390
TAPÓN DE GASOLINA-CON LLAVE	31844
BANDA-COMPRESOR	K070406
TERMOSTATO-188° LADO PILOTO	33964
TERMOSTATO-185° LADO COPILOTO	33965
TAPÓN DE RADIADOR-(13 LBS) SIN PALANCA	31333
TAPÓN DE ACEITE-	31117

2007

TAPÓN DE GASOLINA-SIN LLAVE	31843
BANDA-S/COMPRESOR	K070390
TAPÓN DE GASOLINA-CON LLAVE	31844
BANDA-COMPRESOR	K070406
TERMOSTATO-188° LADO PILOTO	33964
TERMOSTATO-185° LADO COPILOTO	33965
TAPÓN DE RADIADOR-(13 LBS) SIN PALANCA	31333
TAPÓN DE ACEITE-	31117



MASTER SERVICIO PESADO 2014

ISUZU

ELF 400

ELF 400

4HK1-TC

2013

MANGUERA INFERIOR-MOTOR A RAD.	23095
MANGUERA SUPERIOR-MOTOR A RAD.	23096
BANDA-ALT-VENT	PQ17420
BANDA-ALT-AA	8625 GS
TERMOSTATO-188° (LADO PILOTO)	33964
TERMOSTATO-185° (LADO PASAJERO)	33965

2012

MANGUERA INFERIOR-MOTOR A RAD.	23095
MANGUERA SUPERIOR-MOTOR A RAD.	23096
BANDA-ALT-VENT	PQ17420
BANDA-ALT-AA	8625 GS
TERMOSTATO-188° (LADO PILOTO)	33964
TERMOSTATO-185° (LADO PASAJERO)	33965

2011

MANGUERA INFERIOR-MOTOR A RAD.	23095
MANGUERA SUPERIOR-MOTOR A RAD.	23096
BANDA-ALT-VENT	PQ17420
BANDA-ALT-AA	8625 GS
TERMOSTATO-188° (LADO PILOTO)	33964
TERMOSTATO-185° (LADO PASAJERO)	33965

2010

MANGUERA INFERIOR-MOTOR A RAD.	23095
MANGUERA SUPERIOR-MOTOR A RAD.	23096
BANDA-ALT-VENT	PQ17420
BANDA-ALT-AA	8625 GS
TERMOSTATO-188° (LADO PILOTO)	33964
TERMOSTATO-185° (LADO PASAJERO)	33965

2009

MANGUERA INFERIOR-MOTOR A RAD.	23095
MANGUERA SUPERIOR-MOTOR A RAD.	23096
BANDA-ALT-VENT	PQ17420
BANDA-ALT-AA	8625 GS
TERMOSTATO-188° (LADO PILOTO)	33964
TERMOSTATO-185° (LADO PASAJERO)	33965

2008

MANGUERA INFERIOR-MOTOR A RAD.	23095
MANGUERA SUPERIOR-MOTOR A RAD.	23096
BANDA-ALT-VENT	PQ17420
BANDA-ALT-AA	8625 GS
TERMOSTATO-188° (LADO PILOTO)	33964

TERMOSTATO-185° (LADO PASAJERO)

33965

2007

MANGUERA INFERIOR-MOTOR A RAD.	23095
MANGUERA SUPERIOR-MOTOR A RAD.	23096
BANDA-ALT-VENT	PQ17420
BANDA-ALT-AA	8625 GS
TERMOSTATO-188° (LADO PILOTO)	33964
TERMOSTATO-185° (LADO PASAJERO)	33965

2006

MANGUERA INFERIOR-MOTOR A RAD.	23095
MANGUERA SUPERIOR-MOTOR A RAD.	23096
BANDA-ALT-VENT	PQ17420
BANDA-ALT-AA	8625 GS
TERMOSTATO-188° (LADO PILOTO)	33964
TERMOSTATO-185° (LADO PASAJERO)	33965

ELF 450

4HK1-TC

2008

MANGUERA INFERIOR-MOTOR A RAD.	23095
MANGUERA SUPERIOR-MOTOR A RAD.	23096
BANDA-ALT-VENT	PQ17420
BANDA-ALT-AA	9620
TERMOSTATO-188° (LADO PILOTO)	33964
TERMOSTATO-185° (LADO PASAJERO)	33965
TAPÓN DE ACEITE-	31117

2007

MANGUERA INFERIOR-MOTOR A RAD.	23095
BANDA-ALT-VENT	PQ17420
BANDA-ALT-AA	9620
TERMOSTATO-188° (LADO PILOTO)	33964
TERMOSTATO-185° (LADO PASAJERO)	33965
MANGUERA SUPERIOR-	23096
TAPÓN DE ACEITE-	31117

2006

MANGUERA INFERIOR-MOTOR A RAD.	23095
BANDA-ALT-VENT	PQ17420
BANDA-ALT-AA	9620
TERMOSTATO-188° (LADO PILOTO)	33964
TERMOSTATO-185° (LADO PASAJERO)	33965
MANGUERA SUPERIOR-	23096

ELF 500

4HK1-TC

2013



MASTER SERVICIO PESADO 2014

ISUZU

ELF 500

MANGUERA INFERIOR-MOTOR A RAD.	23095	2012	MANGUERA INFERIOR-MOTOR A RAD.	23095
MANGUERA SUPERIOR-MOTOR A RAD.	23096		MANGUERA SUPERIOR-MOTOR A RAD.	23096
BANDA-ALT-VENT	PQ17420		BANDA-ALT-VENT	PQ17420
BANDA-ALT-AA	8625 GS		BANDA-ALT-AA	8625 GS
TERMOSTATO-188° (LADO PILOTO)	33964		TERMOSTATO-188° (LADO PILOTO)	33964
TERMOSTATO-185° (LADO PASAJERO)	33965		TERMOSTATO-185° (LADO PASAJERO)	33965
2012				
MANGUERA INFERIOR-MOTOR A RAD.	23095	2011	MANGUERA INFERIOR-MOTOR A RAD.	23095
MANGUERA SUPERIOR-MOTOR A RAD.	23096		MANGUERA SUPERIOR-MOTOR A RAD.	23096
BANDA-ALT-VENT	PQ17420		BANDA-ALT-VENT	PQ17420
BANDA-ALT-AA	8625 GS		BANDA-ALT-AA	8625 GS
TERMOSTATO-188° (LADO PILOTO)	33964		TERMOSTATO-188° (LADO PILOTO)	33964
TERMOSTATO-185° (LADO PASAJERO)	33965		TERMOSTATO-185° (LADO PASAJERO)	33965
2011				
MANGUERA INFERIOR-MOTOR A RAD.	23095	2010	MANGUERA INFERIOR-MOTOR A RAD.	23095
MANGUERA SUPERIOR-MOTOR A RAD.	23096		MANGUERA SUPERIOR-MOTOR A RAD.	23096
BANDA-ALT-VENT	PQ17420		BANDA-ALT-VENT	PQ17420
BANDA-ALT-AA	8625 GS		BANDA-ALT-AA	8625 GS
TERMOSTATO-188° (LADO PILOTO)	33964		TERMOSTATO-188° (LADO PILOTO)	33964
TERMOSTATO-185° (LADO PASAJERO)	33965		TERMOSTATO-185° (LADO PASAJERO)	33965
2010				
MANGUERA INFERIOR-MOTOR A RAD.	23095	2009	MANGUERA INFERIOR-MOTOR A RAD.	23095
MANGUERA SUPERIOR-MOTOR A RAD.	23096		MANGUERA SUPERIOR-MOTOR A RAD.	23096
BANDA-ALT-VENT	PQ17420		BANDA-ALT-VENT	PQ17420
BANDA-ALT-AA	8625 GS		BANDA-ALT-AA	8625 GS
TERMOSTATO-188° (LADO PILOTO)	33964		TERMOSTATO-188° (LADO PILOTO)	33964
TERMOSTATO-185° (LADO PASAJERO)	33965		TERMOSTATO-185° (LADO PASAJERO)	33965
2009				
MANGUERA INFERIOR-MOTOR A RAD.	23095	ELF 600-BUS		
MANGUERA SUPERIOR-MOTOR A RAD.	23096	4HK1-TC		
BANDA-ALT-VENT	PQ17420	2013	MANGUERA INFERIOR-MOTOR A RAD.	23095
BANDA-ALT-AA	8625 GS		MANGUERA SUPERIOR-MOTOR A RAD.	23096
TERMOSTATO-188° (LADO PILOTO)	33964		BANDA-ALT-VENT	PQ17420
TERMOSTATO-185° (LADO PASAJERO)	33965		BANDA-ALT-AA	8625 GS
ELF 600			TERMOSTATO-188° (LADO PILOTO)	33964
4HK1-TC			TERMOSTATO-185° (LADO PASAJERO)	33965
2013		2012	MANGUERA INFERIOR-MOTOR A RAD.	23095
MANGUERA INFERIOR-MOTOR A RAD.	23095		MANGUERA SUPERIOR-MOTOR A RAD.	23096
MANGUERA SUPERIOR-MOTOR A RAD.	23096		BANDA-ALT-VENT	PQ17420
BANDA-ALT-VENT	PQ17420		BANDA-ALT-AA	8625 GS
BANDA-ALT-AA	8625 GS		TERMOSTATO-188° (LADO PILOTO)	33964
TERMOSTATO-188° (LADO PILOTO)	33964		TERMOSTATO-185° (LADO PASAJERO)	33965
TERMOSTATO-185° (LADO PASAJERO)	33965			



MASTER SERVICIO PESADO 2014

ISUZU

ELF 600-BUS

TERMOSTATO-185° (LADO PASAJERO)	33965	BANDA-VENT- OPCIONAL	9470
2011		BANDA-VENT- OPCIONAL	9500
MANGUERA INFERIOR-MOTOR A RAD.	23095	BANDA-VENT	3/9470PB
MANGUERA SUPERIOR-MOTOR A RAD.	23096	BANDA-VENT	3/9500PB
BANDA-ALT-VENT	PQ17420	BANDA-VENT	9447
BANDA-ALT-AA	8625 GS	BANDA-VENT	9490
TERMOSTATO-188° (LADO PILOTO)	33964	BANDA-ALT-AA	2/9520PB
TERMOSTATO-185° (LADO PASAJERO)	33965	BANDA-ALT-AA	9525

FORWARD 800

4HK1-TC		BANDA-ALT	2/9510PB
2014		TERMOSTATO-190°	33599
BANDA-MOTOR	K070425	BANDA-	9520
2013		BANDA-	9545
BANDA-MOTOR	K070425	BANDA-	9590
2012		MANGUERA DE AGUA-	30T 5/8"
BANDA-MOTOR	K070425	MANGUERA DE PASO-	CHARTER 1 3/4"
		MANGUERA SILICÓN-	SIH250363C

KENWORTH



C500

DETROIT DIESEL 6 CIL, 12.7 L DIESEL		1992	
1994		BANDA-VENT- OPCIONAL	9470
BANDA-VENT- OPCIONAL	9470	BANDA-VENT- OPCIONAL	9500
BANDA-VENT- OPCIONAL	9500	BANDA-VENT	3/9470PB
BANDA-VENT	3/9470PB	BANDA-VENT	3/9500PB
BANDA-VENT	3/9500PB	BANDA-VENT	9447
BANDA-VENT	9447	BANDA-VENT	9490
BANDA-VENT	9490	BANDA-ALT-AA	2/9520PB
MANGUERA SILICÓN-TUBO A RAD.	SIH300363C	BANDA-ALT-AA	9525
MANGUERA SILICÓN-MOTOR A TUBO	SIH250363C	BANDA-ALT	2/9510PB
BANDA-ALT-AA	2/9520PB	TERMOSTATO-190°	33599
BANDA-ALT-AA	9525	BANDA-	9520
BANDA-ALT	2/9500PB	BANDA-	9545
BANDA-ALT	2/9510PB	BANDA-	9590
TERMOSTATO-190°	33599	MANGUERA DE AGUA-	30T 5/8"
BANDA-	9520	MANGUERA DE PASO-	CHARTER 1 3/4"
BANDA-	9545	MANGUERA SILICÓN-	SIH250363C
BANDA-	9590	1991	
MANGUERA DE AGUA-	30T 3/4"	BANDA-VENT- OPCIONAL	9470
MANGUERA DE AGUA-	30T 5/8"	BANDA-VENT- OPCIONAL	9500
MANGUERA SILICÓN-	SIH250363C	BANDA-VENT	3/9470PB
1993		BANDA-VENT	3/9500PB
		BANDA-VENT	9447
		BANDA-VENT	9490
		BANDA-ALT-AA	2/9520PB
		BANDA-ALT-AA	9525



MASTER SERVICIO PESADO 2014

KENWORTH

C500

BANDA-ALT	2/9510PB	MANGUERA DE AGUA-	30T 5/8"
TERMOSTATO-190°	33599	MANGUERA DE PASO-	CHARTER 1 3/4"
BANDA-	9520	MANGUERA SILICÓN-	SIH250363C
BANDA-	9545	1992	
BANDA-	9590	BANDA-VENT- OPCIONAL	9470
MANGUERA DE AGUA-	30T 5/8"	BANDA-VENT- OPCIONAL	9500
MANGUERA DE PASO-	CHARTER 1 3/4"	BANDA-VENT	3/9470PB
MANGUERA SILICÓN-	SIH250363C	BANDA-VENT	3/9500PB
DETROIT DIESEL 6 CIL, 11.1 L DIESEL		BANDA-VENT	9447
1994		BANDA-VENT	9490
BANDA-VENT- OPCIONAL	9470	BANDA-ALT-AA	2/9520PB
BANDA-VENT- OPCIONAL	9500	BANDA-ALT-AA	9525
BANDA-VENT	3/9470PB	BANDA-ALT	2/9510PB
BANDA-VENT	3/9500PB	TERMOSTATO-190°	33599
BANDA-VENT	9447	BANDA-	9520
BANDA-VENT	9490	BANDA-	9545
MANGUERA SILICÓN-TUBO A RAD.	SIH300363C	BANDA-	9590
MANGUERA SILICÓN-MOTOR A TUBO	SIH250363C	MANGUERA DE AGUA-	30T 5/8"
BANDA-ALT-AA	2/9520PB	MANGUERA DE PASO-	CHARTER 1 3/4"
BANDA-ALT-AA	9525	MANGUERA SILICÓN-	SIH250363C
BANDA-ALT	2/9500PB	1991	
BANDA-ALT	2/9510PB	BANDA-VENT- OPCIONAL	9470
TERMOSTATO-190°	33599	BANDA-VENT- OPCIONAL	9500
BANDA-	9520	BANDA-VENT	3/9470PB
BANDA-	9545	BANDA-VENT	3/9500PB
BANDA-	9590	BANDA-VENT	9447
MANGUERA DE AGUA-	30T 3/4"	BANDA-VENT	9490
MANGUERA DE AGUA-	30T 5/8"	BANDA-ALT-AA	2/9520PB
MANGUERA SILICÓN-	SIH250363C	BANDA-ALT-AA	9525
1993		BANDA-ALT	2/9510PB
BANDA-VENT- OPCIONAL	9470	TERMOSTATO-190°	33599
BANDA-VENT- OPCIONAL	9500	BANDA-	9520
BANDA-VENT	3/9470PB	BANDA-	9545
BANDA-VENT	3/9500PB	BANDA-	9590
BANDA-VENT	9447	MANGUERA DE AGUA-	30T 5/8"
BANDA-VENT	9490	MANGUERA DE PASO-	CHARTER 1 3/4"
BANDA-ALT-AA	2/9520PB	MANGUERA SILICÓN-	SIH250363C
BANDA-ALT-AA	9525	CUMMINS M11 DIESEL	
BANDA-ALT	2/9510PB	1998	
TERMOSTATO-190°	33599	TERMOSTATO-190°	33579
BANDA-	9520	TERMOSTATO-180°	33576
BANDA-	9545	TERMOSTATO-180°	33578
BANDA-	9590	TERMOSTATO-170°	33577



1997		TERMOSTATO-175°	33960
TERMOSTATO-190°	33579	TERMOSTATO-170°	33577
TERMOSTATO-180°	33576	CATERPILLAR C16 DIESEL	
TERMOSTATO-180°	33578	2000	
TERMOSTATO-170°	33577	BANDA-VENT	TR22635
1996		MANGUERA SILICÓN-TUBO A RAD.	SIH250363C
TERMOSTATO-190°	33579	MANGUERA SILICÓN-MOTOR A TUBO	SIH200363C
TERMOSTATO-180°	33576	MANGUERA SILICÓN-MOTOR A TUBO	SIH300363C
TERMOSTATO-180°	33578	BANDA-ALT-VENT-AA	9520
TERMOSTATO-170°	33577	TERMOSTATO-175°	33549
1995		CATERPILLAR C15 DIESEL	
TERMOSTATO-190°	33579	2008	
TERMOSTATO-180°	33576	BANDA-VENT-AA	K060516
TERMOSTATO-180°	33578	POLEA-MOTOR	36091
TERMOSTATO-170°	33577	POLEA-MOTOR	36341
1994		BANDA-ALT-VENT	K081124
TERMOSTATO-190°	33579	TENSOR-ALT-VENT	38569
TERMOSTATO-180°	33576	TENSOR-AA	38511
TERMOSTATO-180°	33578	TERMOSTATO-190°	33579
TERMOSTATO-170°	33577	TERMOSTATO-180°	33576
CUMMINS L10 DIESEL		TERMOSTATO-180°	33578
1994		TERMOSTATO-170°	33577
TERMOSTATO-190°	33579	TAPÓN DE RADIADOR-(15 LBS) SIN PALANCA	31350
TERMOSTATO-180°	33576	POLEA DEL TENSOR-	36091
TERMOSTATO-180°	33578	2007	
TERMOSTATO-175°	33960	BANDA-VENT-AA	K060516
TERMOSTATO-170°	33577	POLEA-MOTOR	36091
1993		POLEA-MOTOR	36341
TERMOSTATO-190°	33579	BANDA-ALT-VENT	K081124
TERMOSTATO-180°	33576	TENSOR-ALT-VENT	38569
TERMOSTATO-180°	33578	TENSOR-AA	38511
TERMOSTATO-175°	33960	TERMOSTATO-190°	33579
TERMOSTATO-170°	33577	TERMOSTATO-180°	33576
1992		TERMOSTATO-180°	33578
TERMOSTATO-190°	33579	TERMOSTATO-170°	33577
TERMOSTATO-180°	33576	TAPÓN DE RADIADOR-(15 LBS) SIN PALANCA	31350
TERMOSTATO-180°	33578	POLEA DEL TENSOR-	36091
TERMOSTATO-175°	33960	2003	
TERMOSTATO-170°	33577	BANDA-VENT	TR22635
1991		MANGUERA SILICÓN-TUBO A RAD.	SIH250363C
TERMOSTATO-190°	33579	MANGUERA SILICÓN-MOTOR A TUBO	SIH200363C
TERMOSTATO-180°	33576	MANGUERA SILICÓN-MOTOR A TUBO	SIH300363C
TERMOSTATO-180°	33578	BANDA-ALT-VENT-AA	9520



MASTER SERVICIO PESADO 2014

KENWORTH

C500

TERMOSTATO-190°	33579	TERMOSTATO-180°	33576
TERMOSTATO-180°	33576	TERMOSTATO-180°	33578
TERMOSTATO-180°	33578	TERMOSTATO-170°	33577
TERMOSTATO-170°	33577	CATERPILLAR 3406 DIESEL	
2002		1991	
BANDA-VENT	TR22635	TERMOSTATO-190°	33579
MANGUERA SILICÓN-TUBO A RAD.	SIH250363C	TERMOSTATO-180°	33576
MANGUERA SILICÓN-MOTOR A TUBO	SIH200363C	TERMOSTATO-180°	33578
MANGUERA SILICÓN-MOTOR A TUBO	SIH300363C	TERMOSTATO-170°	33577
BANDA-ALT-VENT-AA	9520	CATERPILLAR 3306 DIESEL	
TERMOSTATO-190°	33579	1992	
TERMOSTATO-180°	33576	BANDA-VENT	9480
TERMOSTATO-180°	33578	BANDA-ALT	2/9530PB
TERMOSTATO-170°	33577	BANDA-ALT	9530
2001		TERMOSTATO-175°	33549
BANDA-VENT	TR22635	BANDA-	9400
MANGUERA SILICÓN-TUBO A RAD.	SIH250363C	MANGUERA DE AGUA-	30T 5/8"
MANGUERA SILICÓN-MOTOR A TUBO	SIH200363C	MANGUERA DE PASO-	24222
MANGUERA SILICÓN-MOTOR A TUBO	SIH300363C	MANGUERA DE PASO-	CHARTER 1 3/4"
BANDA-ALT-VENT-AA	9520	MANGUERA SILICÓN-	SIH250363C
TERMOSTATO-190°	33579	1991	
TERMOSTATO-180°	33576	BANDA-VENT	9480
TERMOSTATO-180°	33578	BANDA-ALT	2/9530PB
TERMOSTATO-170°	33577	BANDA-ALT	9530
2000		TERMOSTATO-175°	33549
BANDA-VENT	TR22635	BANDA-	9400
MANGUERA SILICÓN-TUBO A RAD.	SIH250363C	MANGUERA DE AGUA-	30T 5/8"
MANGUERA SILICÓN-MOTOR A TUBO	SIH200363C	MANGUERA DE PASO-	24222
MANGUERA SILICÓN-MOTOR A TUBO	SIH300363C	MANGUERA DE PASO-	CHARTER 1 3/4"
BANDA-ALT-VENT-AA	9520	MANGUERA SILICÓN-	SIH250363C
TERMOSTATO-190°	33579	CATERPILLAR 3176 DIESEL	
TERMOSTATO-180°	33576	1994	
TERMOSTATO-180°	33578	BANDA-ALT-VENT	K080675
TERMOSTATO-170°	33577	BANDA-ALT-VENT	K080680
CATERPILLAR C13 DIESEL		BANDA-ALT-VENT	K080700
2008		TERMOSTATO-190°	33579
TERMOSTATO-190°	33579	TERMOSTATO-180°	33576
TERMOSTATO-180°	33576	TERMOSTATO-180°	33578
TERMOSTATO-180°	33578	TERMOSTATO-170°	33577
TERMOSTATO-170°	33577	BANDA-	9505
TAPÓN DE RADIADOR-(15 LBS) SIN PALANCA	31350	BANDA-	9540
2007		BANDA-	9560
TERMOSTATO-190°	33579	1993	



MASTER SERVICIO PESADO 2014

KENWORTH

C500

MANGUERA SILICÓN-TUBO A TUBO	SIH250363C	TERMOSTATO-180°	33576
MANGUERA SILICÓN-TUBO A RAD.	SIH300363C	TERMOSTATO-180°	33578
MANGUERA INFERIOR-MOTOR A TUBO	24436	TERMOSTATO-170°	33577
MANGUERA SILICÓN-MOTOR A TUBO	SIH200363C	1996	
BANDA-ALT-VENT	K080675	TERMOSTATO-190°	33579
BANDA-ALT-VENT	K080680	TERMOSTATO-180°	33576
BANDA-ALT-VENT	K080700	TERMOSTATO-180°	33578
TERMOSTATO-190°	33579	TERMOSTATO-170°	33577
TERMOSTATO-180°	33576	K100	
TERMOSTATO-180°	33578	DETROIT DIESEL SERIE 60, 12.7 L	
TERMOSTATO-170°	33577	1993	
BANDA-	9505	BANDA-VENT	PQ17550
BANDA-	9540	BANDA-BA	PQ17530
BANDA-	9560	1992	
MANGUERA DE AGUA-	30T 5/8"	BANDA-VENT	PQ17550
MANGUERA DE CALEFACCIÓN-	CHARTER 1"	BANDA-BA	PQ17530
1992		1991	
MANGUERA INFERIOR-TUBO A RAD.	24436	BANDA-VENT	PQ17550
MANGUERA SILICÓN-TUBO A RAD.	SIH250363C	BANDA-BA	PQ17530
MANGUERA INFERIOR-MOTOR A TUBO	24436	DETROIT DIESEL SERIE 60, 11.1 L	
MANGUERA SILICÓN-MOTOR A TUBO	SIH200363C	1993	
BANDA-ALT-VENT	K080675	BANDA-VENT	PQ17550
BANDA-ALT-VENT	K080680	BANDA-BA	PQ17530
BANDA-ALT-VENT	K080700	1992	
TERMOSTATO-190°	33579	BANDA-VENT	PQ17550
TERMOSTATO-180°	33576	BANDA-BA	PQ17530
TERMOSTATO-180°	33578	1991	
TERMOSTATO-170°	33577	BANDA-VENT	PQ17550
BANDA-	9505	BANDA-BA	PQ17530
BANDA-	9540	DETROIT DIESEL SERIE 60	
BANDA-	9560	1999	
MANGUERA DE AGUA-	30T 5/8"	MANGUERA DE CALEFACCIÓN-	35B 5/8"
MANGUERA DE CALEFACCIÓN-	CHARTER 1"	MANGUERA DE CALEFACCIÓN-	CHARTER 3/4"
C500			
CUMMINS M11 DIESEL			
1998		1998	
TERMOSTATO-190°	33579	MANGUERA DE CALEFACCIÓN-	35B 5/8"
TERMOSTATO-180°	33576	MANGUERA DE CALEFACCIÓN-	CHARTER 3/4"
TERMOSTATO-180°	33578	MANGUERA INFERIOR-	CHARTER 2 1/2"
TERMOSTATO-170°	33577	MANGUERA INFERIOR-	CHARTER 3"
1997		MANGUERA SUPERIOR-	CHARTER 2 1/2"
TERMOSTATO-190°	33579	1997	
		MANGUERA DE CALEFACCIÓN-	35B 5/8"



MASTER SERVICIO PESADO 2014

KENWORTH

K100

MANGUERA DE CALEFACCIÓN-	CHARTER 3/4"	MANGUERA DE CALEFACCIÓN-	35B 5/8"
MANGUERA INFERIOR-	CHARTER 2 1/2"	MANGUERA DE PASO-	CHARTER 1 3/4"
MANGUERA INFERIOR-	CHARTER 3"	MANGUERA INFERIOR-	CHARTER 2 1/2"
MANGUERA SUPERIOR-	CHARTER 2 1/2"	MANGUERA SUPERIOR-	CHARTER 2 1/2"
1996		1990	
BANDA-ALT	2/9325PB	MANGUERA DE CALEFACCIÓN-	35B 5/8"
MANGUERA DE CALEFACCIÓN-	35B 5/8"	MANGUERA DE PASO-	CHARTER 1 3/4"
MANGUERA DE CALEFACCIÓN-	CHARTER 3/4"	MANGUERA INFERIOR-	CHARTER 2 1/2"
MANGUERA INFERIOR-	CHARTER 2 1/2"	MANGUERA SUPERIOR-	CHARTER 2 1/2"
MANGUERA INFERIOR-	CHARTER 3"	DETROIT DIESEL 6 CIL, 12.7 L DIESEL	
MANGUERA SUPERIOR-	CHARTER 2 1/2"	1996	
1995		MANGUERA SILICÓN-TUBO A RAD.	SIH300363C
MANGUERA DE CALEFACCIÓN-	35B 5/8"	MANGUERA SILICÓN-MOTOR A TUBO	SIH250363C
MANGUERA DE CALEFACCIÓN-	CHARTER 3/4"	BANDA-ALT	2/9325PB
MANGUERA INFERIOR-	CHARTER 2 1/2"	TERMOSTATO-190°	33599
MANGUERA INFERIOR-	CHARTER 3"	MANGUERA DE AGUA-	30T 3/4"
MANGUERA SUPERIOR-	CHARTER 2 1/2"	MANGUERA DE AGUA-	30T 5/8"
1994		MANGUERA SILICÓN-	SIH250363C
MANGUERA DE CALEFACCIÓN-	35B 5/8"	1995	
MANGUERA DE CALEFACCIÓN-	CHARTER 3/4"	MANGUERA SILICÓN-TUBO A RAD.	SIH300363C
MANGUERA INFERIOR-	CHARTER 2 1/2"	MANGUERA SILICÓN-MOTOR A TUBO	SIH250363C
MANGUERA INFERIOR-	CHARTER 3"	BANDA-ALT	2/9325PB
MANGUERA SUPERIOR-	CHARTER 2 1/2"	TERMOSTATO-190°	33599
1993		MANGUERA DE AGUA-	30T 3/4"
BANDA-VENT	PQ17550	MANGUERA DE AGUA-	30T 5/8"
BANDA-ALT-AA	2/9520PB	MANGUERA SILICÓN-	SIH250363C
BANDA-ALT-AA	PQ17530	1994	
MANGUERA DE CALEFACCIÓN-	35B 5/8"	MANGUERA SILICÓN-TUBO A RAD.	SIH300363C
MANGUERA DE PASO-	CHARTER 1 3/4"	MANGUERA SILICÓN-MOTOR A TUBO	SIH250363C
MANGUERA INFERIOR-	CHARTER 2 1/2"	BANDA-ALT	2/9325PB
MANGUERA SUPERIOR-	CHARTER 2 1/2"	TERMOSTATO-190°	33599
1992		MANGUERA DE AGUA-	30T 3/4"
BANDA-VENT	PQ17550	MANGUERA DE AGUA-	30T 5/8"
BANDA-ALT-AA	2/9520PB	MANGUERA SILICÓN-	SIH250363C
BANDA-ALT-AA	PQ17530	1993	
MANGUERA DE CALEFACCIÓN-	35B 5/8"	BANDA-VENT	9550
MANGUERA DE PASO-	CHARTER 1 3/4"	BANDA-ALT-AA	2/9520PB
MANGUERA INFERIOR-	CHARTER 2 1/2"	BANDA-ALT-AA	9525
MANGUERA SUPERIOR-	CHARTER 2 1/2"	TERMOSTATO-190°	33599
1991		MANGUERA DE AGUA-	30T 5/8"
BANDA-VENT	PQ17550	MANGUERA DE PASO-	CHARTER 1 3/4"
BANDA-ALT-AA	2/9520PB	MANGUERA SILICÓN-	SIH250363C
BANDA-ALT-AA	PQ17530	1992	



BANDA-VENT	9550	BANDA-ALT-AA	9525
BANDA-ALT-AA	2/9520PB	TERMOSTATO-190°	33599
BANDA-ALT-AA	9525	MANGUERA DE AGUA-	30T 5/8"
TERMOSTATO-190°	33599	MANGUERA DE PASO-	CHARTER 1 3/4"
MANGUERA DE AGUA-	30T 5/8"	MANGUERA SILICÓN-	SIH250363C
MANGUERA DE PASO-	CHARTER 1 3/4"	CUMMINS N14 DIESEL	
MANGUERA SILICÓN-	SIH250363C	1993	
1991		BANDA-VENT- OPCIONAL	TR28400
BANDA-VENT	9550	BANDA-VENT- OPCIONAL	TR28492
BANDA-ALT-AA	2/9520PB	BANDA-VENT- OPCIONAL	TR28501
BANDA-ALT-AA	9525	BANDA-VENT	2/TR28400PB
TERMOSTATO-190°	33599	BANDA-VENT	2/TR28492PB
MANGUERA DE AGUA-	30T 5/8"	BANDA-VENT	2/TR28501PB
MANGUERA DE PASO-	CHARTER 1 3/4"	BANDA-VENT	K080415
MANGUERA SILICÓN-	SIH250363C	BANDA-VENT	K080427
DETROIT DIESEL 6 CIL, 11.1 L DIESEL		BANDA-VENT	K080465
1996		BANDA-VENT	PQ28400
MANGUERA SILICÓN-TUBO A RAD.	SIH300363C	BANDA-VENT	PQ28492
MANGUERA SILICÓN-MOTOR A TUBO	SIH250363C	BANDA-VENT	PQ28501
BANDA-ALT	2/9325PB	BANDA-VENT	TR24457
TERMOSTATO-190°	33599	MANGUERA SILICÓN-TUBO A RAD.	SIH300363C
MANGUERA DE AGUA-	30T 3/4"	MANGUERA SUPERIOR-TUBO A RAD.	CHARTER 3"
MANGUERA DE AGUA-	30T 5/8"	MANGUERA SILICÓN-MOTOR A TUBO	SIH250363C
MANGUERA SILICÓN-	SIH250363C	MANGUERA SUPERIOR-MOTOR A TUBO	24436
1993		MANGUERA SUPERIOR-MOTOR A TUBO	CHARTER 2 1/4"
BANDA-VENT	9550	BANDA-BA	6596
BANDA-ALT-AA	2/9520PB	BANDA-BA	K040430
BANDA-ALT-AA	9525	BANDA-BA	K040445
TERMOSTATO-190°	33599	BANDA-BA	K060435
MANGUERA DE AGUA-	30T 5/8"	BANDA-BA	PQ24434
MANGUERA DE PASO-	CHARTER 1 3/4"	BANDA-BA	TR24438
MANGUERA SILICÓN-	SIH250363C	BANDA-ALT	9470
1992		BANDA-ALT	PQ17470
BANDA-VENT	9550	BANDA-AA	8400 GS
BANDA-ALT-AA	2/9520PB	BANDA-AA	8405 GS
BANDA-ALT-AA	9525	BANDA-AA	PQ17400
TERMOSTATO-190°	33599	BANDA-AA	PQ17430
MANGUERA DE AGUA-	30T 5/8"	TERMOSTATO-190°	33579
MANGUERA DE PASO-	CHARTER 1 3/4"	TERMOSTATO-180°	33576
MANGUERA SILICÓN-	SIH250363C	TERMOSTATO-180°	33578
1991		TERMOSTATO-170°	33577
BANDA-VENT	9550	BANDA-	9395
BANDA-ALT-AA	2/9520PB		



MASTER SERVICIO PESADO 2014

KENWORTH

K100

BANDA-	9400	TERMOSTATO-180°	33578
BANDA-	9405	TERMOSTATO-170°	33577
BANDA-	9430	BANDA-	9395
MANGUERA DE AGUA-	30T 5/8"	BANDA-	9400
MANGUERA DE CALEFACCIÓN-	35B 5/8"	BANDA-	9405
MANGUERA DE PASO-	CHARTER 1 1/2"	BANDA-	9430
MANGUERA INFERIOR-	CHARTER 1 1/4"	MANGUERA DE AGUA-	30T 5/8"
MANGUERA INFERIOR-	CHARTER 2 1/2"	MANGUERA DE CALEFACCIÓN-	35B 5/8"
MANGUERA INFERIOR-	CHARTER 3"	MANGUERA DE PASO-	CHARTER 1 1/2"
1992		MANGUERA INFERIOR-	CHARTER 1 1/4"
BANDA-VENT- OPCIONAL	TR28400	MANGUERA INFERIOR-	CHARTER 2 1/2"
BANDA-VENT- OPCIONAL	TR28492	MANGUERA INFERIOR-	CHARTER 3"
BANDA-VENT- OPCIONAL	TR28501	CUMMINS M11 DIESEL	
BANDA-VENT	2/TR28400PB	1996	
BANDA-VENT	2/TR28492PB	TERMOSTATO-190°	33579
BANDA-VENT	2/TR28501PB	TERMOSTATO-180°	33576
BANDA-VENT	K080415	TERMOSTATO-180°	33578
BANDA-VENT	K080427	TERMOSTATO-170°	33577
BANDA-VENT	K080465	1995	
BANDA-VENT	PQ28400	TERMOSTATO-190°	33579
BANDA-VENT	PQ28492	TERMOSTATO-180°	33576
BANDA-VENT	PQ28501	TERMOSTATO-180°	33578
BANDA-VENT	TR24457	TERMOSTATO-170°	33577
MANGUERA SILICÓN-TUBO A RAD.	SIH300363C	1994	
MANGUERA SUPERIOR-TUBO A RAD.	CHARTER 3"	TERMOSTATO-190°	33579
MANGUERA SILICÓN-MOTOR A TUBO	SIH250363C	TERMOSTATO-180°	33576
MANGUERA SUPERIOR-MOTOR A TUBO	24436	TERMOSTATO-180°	33578
MANGUERA SUPERIOR-MOTOR A TUBO	CHARTER 2 1/4"	TERMOSTATO-170°	33577
BANDA-BA	6596	CUMMINS L10 DIESEL	
BANDA-BA	K040430	1994	
BANDA-BA	K040445	TERMOSTATO-190°	33579
BANDA-BA	K060435	TERMOSTATO-180°	33576
BANDA-BA	PQ24434	TERMOSTATO-180°	33578
BANDA-BA	TR24438	TERMOSTATO-175°	33960
BANDA-ALT	9470	TERMOSTATO-170°	33577
BANDA-ALT	PQ17470	1993	
BANDA-AA	8400 GS	TERMOSTATO-190°	33579
BANDA-AA	8405 GS	TERMOSTATO-180°	33576
BANDA-AA	PQ17400	TERMOSTATO-180°	33578
BANDA-AA	PQ17430	TERMOSTATO-175°	33960
TERMOSTATO-190°	33579	TERMOSTATO-170°	33577
TERMOSTATO-180°	33576	1992	
		TERMOSTATO-190°	33579



TERMOSTATO-180°	33576	BANDA-VENT- OPCIONAL	TR28501
TERMOSTATO-180°	33578	BANDA-VENT	2/TR28400PB
TERMOSTATO-175°	33960	BANDA-VENT	2/TR28492PB
TERMOSTATO-170°	33577	BANDA-VENT	2/TR28501PB
1991		BANDA-VENT	K080415
TERMOSTATO-190°	33579	BANDA-VENT	K080427
TERMOSTATO-180°	33576	BANDA-VENT	K080465
TERMOSTATO-180°	33578	BANDA-VENT	TR24457
TERMOSTATO-175°	33960	MANGUERA SILICÓN-TUBO A RAD.	SIH300363C
TERMOSTATO-170°	33577	MANGUERA SILICÓN-MOTOR A TUBO	SIH250363C
CUMMINS C Series 8.3 L DIESEL		MANGUERA SUPERIOR-MOTOR A TUBO	24436
1993		BANDA-BA	6596
MANGUERA INFERIOR-TUBO A RAD.	21378	BANDA-BA	K040430
MANGUERA INFERIOR FLEXIBLE-TUBO A RAD.	2T200	BANDA-BA	K040445
MANGUERA SILICÓN-TUBO A RAD.	SIH200363C	BANDA-BA	K060435
MANGUERA INFERIOR-MOTOR A TUBO	21901	BANDA-BA	TR24438
MANGUERA SUPERIOR-MOTOR A TUBO	20532	BANDA-ALT	9470
BANDA-ALT-VENT	K080685	TERMOSTATO-180°	33961
BANDA-ALT-BA	K080560	TERMOSTATO-180°	33962
BANDA-ALT-BA	K080590	BANDA-	9395
BANDA-ALT-BA	K080825	BANDA-	9400
TERMOSTATO-180°-C/DOBLE TERMOSTATO	33966	BANDA-	9405
TERMOSTATO-180°	33959	BANDA-	9430
BANDA-	9485	MANGUERA DE AGUA-	30T 5/8"
MANGUERA DE AGUA-	30T 5/8"	MANGUERA DE PASO-	CHARTER 1 1/2"
1992		CATERPILLAR 3406 DIESEL	
MANGUERA INFERIOR-TUBO A RAD.	21378	1994	
MANGUERA INFERIOR FLEXIBLE-TUBO A RAD.	2T200	TERMOSTATO-190°	33579
MANGUERA SILICÓN-TUBO A RAD.	SIH200363C	TERMOSTATO-180°	33576
MANGUERA INFERIOR-MOTOR A TUBO	21901	TERMOSTATO-180°	33578
MANGUERA SUPERIOR-MOTOR A TUBO	20532	TERMOSTATO-170°	33577
BANDA-ALT-VENT	K080685	MANGUERA DE AGUA-	30T 5/8"
BANDA-ALT-BA	K080560	MANGUERA DE PASO-	CHARTER 1"
BANDA-ALT-BA	K080590	MANGUERA SILICÓN-	SIH250363C
BANDA-ALT-BA	K080825	MANGUERA SILICÓN-	SIH300363C
TERMOSTATO-180°-C/DOBLE TERMOSTATO	33966	1993	
TERMOSTATO-180°	33959	BANDA-VENT	TR22588
BANDA-	9485	BANDA-ALT-AA	2/9540PB
MANGUERA DE AGUA-	30T 5/8"	BANDA-ALT-AA	9540
CUMMINS 6 CIL, 14.0 L DIESEL		TERMOSTATO-190°	33579
1991		TERMOSTATO-180°	33576
BANDA-VENT- OPCIONAL	TR28400	TERMOSTATO-180°	33578
BANDA-VENT- OPCIONAL	TR28492	TERMOSTATO-170°	33577



MASTER SERVICIO PESADO 2014

KENWORTH

K100

MANGUERA DE AGUA-	30T 5/8"	1992	
MANGUERA DE PASO-	CHARTER 1"	TERMOSTATO-190°	33579
MANGUERA SILICÓN-	SIH250363C	TERMOSTATO-180°	33576
MANGUERA SILICÓN-	SIH300363C	TERMOSTATO-180°	33578
1992		TERMOSTATO-170°	33577
BANDA-VENT	TR22588	1991	
BANDA-ALT-AA	2/9540PB	TERMOSTATO-190°	33579
BANDA-ALT-AA	9540	TERMOSTATO-180°	33576
TERMOSTATO-190°	33579	TERMOSTATO-180°	33578
TERMOSTATO-180°	33576	TERMOSTATO-170°	33577
TERMOSTATO-180°	33578		
TERMOSTATO-170°	33577		
MANGUERA DE AGUA-	30T 5/8"		
MANGUERA DE PASO-	CHARTER 1"	TERMOSTATO-180°-C/DOBLE TERMOSTATO	33966
MANGUERA SILICÓN-	SIH250363C	TERMOSTATO-180°	33959
MANGUERA SILICÓN-	SIH300363C	1999	
1991		TERMOSTATO-180°-C/DOBLE TERMOSTATO	33966
BANDA-VENT	TR22588	TERMOSTATO-180°	33959
BANDA-VENT	TR22607		
BANDA-ALT-AA	2/9540PB		
BANDA-ALT-AA	2/9570PB	BANDA-VENT-AA	9480
BANDA-ALT-AA	9540	BANDA-ALT-BA-VENT	K080675
BANDA-ALT-AA	9570	TERMOSTATO-190°	33915
TERMOSTATO-190°	33579	TERMOSTATO-180°	33956
TERMOSTATO-180°	33576	2000	
TERMOSTATO-180°	33578	BANDA-VENT-AA	9480
TERMOSTATO-170°	33577	BANDA-ALT-BA-VENT	K080675
MANGUERA DE AGUA-	30T 5/8"	TERMOSTATO-190°	33915
MANGUERA DE PASO-	CHARTER 1"	TERMOSTATO-180°	33956
MANGUERA SILICÓN-	SIH250363C	1999	
MANGUERA SILICÓN-	SIH300363C	TERMOSTATO-190°	33915
1990		TERMOSTATO-180°	33956
BANDA-VENT	TR22607		
BANDA-ALT-AA	2/9570PB		
BANDA-ALT-AA	9570	BANDA-ALT-BA	K080590
MANGUERA DE CALEFACCIÓN-	35B 5/8"	TERMOSTATO-180°-C/DOBLE TERMOSTATO	33966
MANGUERA DE PASO-	CHARTER 1"	TERMOSTATO-180°	33959
MANGUERA INFERIOR-	CHARTER 3"	BANDA-	9390
MANGUERA SUPERIOR-	CHARTER 2 1/2"	1996	
CATERPILLAR 3306 DIESEL		BANDA-ALT-BA	K080575
1991		BANDA-ALT-BA	K080590
TERMOSTATO-175°	33549	TERMOSTATO-180°-C/DOBLE TERMOSTATO	33966
CATERPILLAR 3176 DIESEL			



TERMOSTATO-180°	33959		T2000
BANDA-	9390		
1995			DETROIT DIESEL SERIE 60, 12.7 L
MANGUERA INFERIOR-TUBO A RAD.	26532	1999	BANDA-VENT PQ17470
MANGUERA SUPERIOR-TUBO A RAD.	20970		BANDA-ALT PQ17520
MANGUERA INFERIOR-MOTOR A TUBO	21901	1998	
BANDA-MOTOR	K081020		BANDA-VENT PQ17470
BANDA-ALT-BA	K080575		BANDA-ALT PQ17520
BANDA-ALT-BA	K080590	1997	
TERMOSTATO-180°-C/DOBLE TERMOSTATO	33966		BANDA-VENT PQ17470
TERMOSTATO-180°	33959		BANDA-ALT PQ17520
BANDA-	9390		DETROIT DIESEL SERIE 60, 11.1 L
1994		1999	
MANGUERA SILICÓN-TUBO A RAD.	SIH200363C		BANDA-VENT PQ17470
MANGUERA SUPERIOR-MOTOR A TUBO	24436		BANDA-ALT PQ17520
BANDA-ALT-BA	K080575	1998	
BANDA-ALT-BA	K080590		BANDA-VENT PQ17470
TERMOSTATO-180°-C/DOBLE TERMOSTATO	33966		BANDA-ALT PQ17520
TERMOSTATO-180°	33959	1997	
BANDA-	9390		BANDA-VENT PQ17470
1993			BANDA-ALT PQ17520
MANGUERA SILICÓN-TUBO A RAD.	SIH200363C		DETROIT DIESEL SERIE 60
MANGUERA SUPERIOR-MOTOR A TUBO	24436	2000	
BANDA-ALT-BA	K080575		BANDA-VENT PQ17470
BANDA-ALT-BA	K080590		MANGUERA SUPERIOR-TUBO A RAD. 26529
TERMOSTATO-180°-C/DOBLE TERMOSTATO	33966		BANDA-TOMA DE FUERZA-ALT-AA K080580
TERMOSTATO-180°	33959		BANDA-TOMA DE FUERZA-ALT-AA PQ17500
BANDA-	9390		MANGUERA SUPERIOR-MOTOR A TUBO CHARTER 2 1/2"
CUMMINS B Series 5.9 L DIESEL			MANGUERA INFERIOR- CHARTER 2 1/2"
1997		1999	
TERMOSTATO-180°	33888		BANDA-VENT PQ17470
1996			BANDA-ALT-AA PQ17530
BANDA-VENT-AA	9480		MANGUERA INFERIOR- CHARTER 2 1/2"
BANDA-ALT-BA-VENT	K080675		MANGUERA SUPERIOR- CHARTER 2 1/2"
TERMOSTATO-180°	33888	1998	
1995			BANDA-VENT PQ17470
BANDA-VENT-AA	9480		BANDA-ALT-AA PQ17530
BANDA-ALT-BA-VENT	K080675		MANGUERA INFERIOR- CHARTER 2 1/2"
TERMOSTATO-180°	33888		MANGUERA SUPERIOR- CHARTER 2 1/2"
1994			DETROIT DIESEL 6 CIL, 12.7 L DIESEL
TERMOSTATO-180°	33888	2000	
1993			BANDA-VENT- OPCIONAL 9470
TERMOSTATO-180°	33758		BANDA-VENT 3/9470PB
			MANGUERA SILICÓN-TUBO A RAD. SIH250363C



MASTER SERVICIO PESADO 2014

KENWORTH

T2000

MANGUERA SUPERIOR FLEXIBLE-TUBO A RAD.	25T140 GS	1998	
BANDA-TOMA DE FUERZA-ALT-AA	9495	BANDA-VENT- OPCIONAL	9470
BANDA-TOMA DE FUERZA-ALT-AA	K080580	BANDA-VENT	3/9470PB
POLEA DEL TENSOR-TOMA DE FUERZA-ALT-AA	38075	BANDA-ALT-AA	9525
TENSOR-TOMA DE FUERZA-ALT-AA	38501	TERMOSTATO-190°	33599
MANGUERA SILICÓN-MOTOR A TUBO	SIH250363C	MANGUERA SILICÓN-	SIH250363C
TERMOSTATO-190°	33599	1997	
1999		BANDA-VENT- OPCIONAL	9470
BANDA-VENT- OPCIONAL	9470	BANDA-VENT	3/9470PB
BANDA-VENT	3/9470PB	BANDA-ALT-AA	9525
BANDA-ALT-AA	9525	TERMOSTATO-190°	33599
TERMOSTATO-190°	33599	MANGUERA SILICÓN-	SIH250363C
MANGUERA SILICÓN-	SIH250363C	CUMMINS SIGNATURE 600 DIESEL	
1998		1999	
BANDA-VENT- OPCIONAL	9470	BANDA-VENT	K100570
BANDA-VENT	3/9470PB	BANDA-ALT-AA	K060660
BANDA-ALT-AA	9525	CUMMINS N14 DIESEL	
TERMOSTATO-190°	33599	2003	
MANGUERA SILICÓN-	SIH250363C	TERMOSTATO-190°	33579
1997		TERMOSTATO-180°	33576
BANDA-VENT- OPCIONAL	9470	TERMOSTATO-180°	33578
BANDA-VENT	3/9470PB	TERMOSTATO-170°	33577
BANDA-ALT-AA	9525	2002	
TERMOSTATO-190°	33599	TERMOSTATO-190°	33579
MANGUERA SILICÓN-	SIH250363C	TERMOSTATO-180°	33576
DETROIT DIESEL 6 CIL, 11.1 L DIESEL		TERMOSTATO-180°	33578
2000		TERMOSTATO-170°	33577
BANDA-VENT- OPCIONAL	9470	2001	
BANDA-VENT	3/9470PB	TERMOSTATO-190°	33579
MANGUERA SILICÓN-TUBO A RAD.	SIH250363C	TERMOSTATO-180°	33576
MANGUERA SUPERIOR FLEXIBLE-TUBO A RAD.	25T140 GS	TERMOSTATO-180°	33578
BANDA-TOMA DE FUERZA-ALT-AA	9495	TERMOSTATO-170°	33577
BANDA-TOMA DE FUERZA-ALT-AA	K080580	2000	
POLEA DEL TENSOR-TOMA DE FUERZA-ALT-AA	38075	MANGUERA SILICÓN-TUBO A RAD.	SIH250363C
TENSOR-TOMA DE FUERZA-ALT-AA	38501	MANGUERA SUPERIOR-TUBO A RAD.	26529
MANGUERA SILICÓN-MOTOR A TUBO	SIH250363C	MANGUERA SUPERIOR FLEXIBLE-TUBO A RAD.	25T140 GS
TERMOSTATO-190°	33599	BANDA-TOMA DE FUERZA-VENT	2/TR28411PB
1999		BANDA-TOMA DE FUERZA-VENT	PQ28412
BANDA-VENT- OPCIONAL	9470	BANDA-TOMA DE FUERZA-VENT	TR28412
BANDA-VENT	3/9470PB	BANDA-TOMA DE FUERZA-BA	K060425
BANDA-ALT-AA	9525	BANDA-TOMA DE FUERZA-AA	9420
TERMOSTATO-190°	33599	BANDA-TOMA DE FUERZA-AA	PQ17420
MANGUERA SILICÓN-	SIH250363C	MANGUERA SILICÓN-MOTOR A TUBO	SIH250363C



MASTER SERVICIO PESADO 2014

KENWORTH

T2000

MANGUERA SUPERIOR-MOTOR A TUBO	CHARTER 2 1/2"	BANDA-TOMA DE FUERZA-VENT	2/TR28411PB
TERMOSTATO-190°	33579	BANDA-TOMA DE FUERZA-VENT	TR28412
TERMOSTATO-180°	33576	BANDA-TOMA DE FUERZA-BA	K060425
TERMOSTATO-180°	33578	BANDA-TOMA DE FUERZA-AA	9420
TERMOSTATO-170°	33577	MANGUERA SILICÓN-MOTOR A TUBO	SIH250363C
MANGUERA INFERIOR-	CHARTER 2 1/2"	BANDA-ALT	9451
1999		TERMOSTATO-190°	33579
MANGUERA SILICÓN-TUBO A RAD.	SIH250363C	TERMOSTATO-180°	33576
MANGUERA SUPERIOR-TUBO A RAD.	26529	TERMOSTATO-180°	33578
MANGUERA SUPERIOR FLEXIBLE-TUBO A RAD.	25T140 GS	TERMOSTATO-170°	33577
BANDA-TOMA DE FUERZA-VENT	2/TR28411PB	1996	
BANDA-TOMA DE FUERZA-VENT	PQ28412	BANDA-VENT	PQ28412
BANDA-TOMA DE FUERZA-VENT	TR28412	BANDA-ALT	PQ17460
BANDA-TOMA DE FUERZA-BA	K060425	BANDA-AA	8416 GS
BANDA-TOMA DE FUERZA-AA	9420	CUMMINS M11 DIESEL	
BANDA-TOMA DE FUERZA-AA	PQ17420	1998	
MANGUERA SILICÓN-MOTOR A TUBO	SIH250363C	TERMOSTATO-190°	33579
MANGUERA SUPERIOR-MOTOR A TUBO	CHARTER 2 1/2"	TERMOSTATO-180°	33576
TERMOSTATO-190°	33579	TERMOSTATO-180°	33578
TERMOSTATO-180°	33576	TERMOSTATO-170°	33577
TERMOSTATO-180°	33578	1997	
TERMOSTATO-170°	33577	TERMOSTATO-190°	33579
MANGUERA INFERIOR-	CHARTER 2 1/2"	TERMOSTATO-180°	33576
1998		TERMOSTATO-180°	33578
MANGUERA SILICÓN-TUBO A RAD.	SIH250363C	TERMOSTATO-170°	33577
MANGUERA SUPERIOR-TUBO A RAD.	26529	1996	
MANGUERA SUPERIOR FLEXIBLE-TUBO A RAD.	25T140 GS	BANDA-VENT	K080485
BANDA-TOMA DE FUERZA-VENT	2/TR28411PB	BANDA-ALT	K050336
BANDA-TOMA DE FUERZA-VENT	PQ28412	BANDA-AA	PQ17520
BANDA-TOMA DE FUERZA-VENT	TR28412	CUMMINS ISX INTERBRAKE	
BANDA-TOMA DE FUERZA-BA	K060425	2000	
BANDA-TOMA DE FUERZA-AA	9420	BANDA-ALT	K060721
BANDA-TOMA DE FUERZA-AA	PQ17420	CUMMINS ISX DIESEL	
MANGUERA SILICÓN-MOTOR A TUBO	SIH250363C	2006	
MANGUERA SUPERIOR-MOTOR A TUBO	CHARTER 2 1/2"	MANGUERA SILICÓN-TUBO A RAD.	SIH250363C
TERMOSTATO-190°	33579	MANGUERA SUPERIOR FLEXIBLE-TUBO A RAD.	25T160 GS
TERMOSTATO-180°	33576	BANDA-TOMA DE FUERZA-ALT-VENT	K120864
TERMOSTATO-180°	33578	BANDA-TOMA DE FUERZA-AA	K060637
TERMOSTATO-170°	33577	MANGUERA INFERIOR-MOTOR A TUBO	21591
MANGUERA INFERIOR-	CHARTER 2 1/2"	MANGUERA SILICÓN-MOTOR A TUBO	SIH250363C
1997		TENSOR-ALT-VENT	38587
MANGUERA SILICÓN-TUBO A RAD.	SIH250363C	2005	
MANGUERA SUPERIOR FLEXIBLE-TUBO A RAD.	25T140 GS	MANGUERA SILICÓN-TUBO A RAD.	SIH250363C



MASTER SERVICIO PESADO 2014

KENWORTH

T2000

MANGUERA SUPERIOR FLEXIBLE-TUBO A RAD.	25T160 GS	MANGUERA SILICÓN-MOTOR A TUBO	SIH250363C
BANDA-TOMA DE FUERZA-ALT-VENT	K120864	BANDA-ALT-BA-AA	K060685
BANDA-TOMA DE FUERZA-AA	K060637	2000	
MANGUERA INFERIOR-MOTOR A TUBO	21591	BANDA-VENT	K100675
MANGUERA SILICÓN-MOTOR A TUBO	SIH250363C	POLEA DEL TENSOR-VENT	36092
TENSOR-ALT-VENT	38587	TENSOR-VENT	38535
2004		MANGUERA SILICÓN-TUBO A RAD.	SIH250363C
MANGUERA SILICÓN-TUBO A RAD.	SIH250363C	MANGUERA SUPERIOR-TUBO A RAD.	26532
MANGUERA SUPERIOR FLEXIBLE-TUBO A RAD.	25T160 GS	POLEA DEL TENSOR-TOMA DE FUERZA-ALT-AA	36095
BANDA-TOMA DE FUERZA-ALT-VENT	K120864	TENSOR-TOMA DE FUERZA-ALT-AA	38532
BANDA-TOMA DE FUERZA-AA	K060637	MANGUERA SILICÓN-MOTOR A TUBO	SIH250363C
MANGUERA INFERIOR-MOTOR A TUBO	21591	BANDA-ALT-BA-AA	K060685
MANGUERA SILICÓN-MOTOR A TUBO	SIH250363C	1999	
TENSOR-ALT-VENT	38587	BANDA-VENT	K100675
2003		POLEA DEL TENSOR-VENT	36092
BANDA-VENT	K100675	TENSOR-VENT	38535
POLEA DEL TENSOR-VENT	36092	MANGUERA SILICÓN-TUBO A RAD.	SIH250363C
TENSOR-VENT	38535	MANGUERA SUPERIOR-TUBO A RAD.	26532
MANGUERA SILICÓN-TUBO A RAD.	SIH250363C	POLEA DEL TENSOR-TOMA DE FUERZA-ALT-AA	36095
MANGUERA SUPERIOR-TUBO A RAD.	26532	TENSOR-TOMA DE FUERZA-ALT-AA	38532
POLEA DEL TENSOR-TOMA DE FUERZA-ALT-AA	36095	MANGUERA SILICÓN-MOTOR A TUBO	SIH250363C
TENSOR-TOMA DE FUERZA-ALT-AA	38532	BANDA-ALT-BA-AA	K060685
MANGUERA SILICÓN-MOTOR A TUBO	SIH250363C	CATERPILLAR C16 DIESEL	
BANDA-ALT-BA-AA	K060685	2003	
2002		BANDA-VENT- OPCIONAL	TR22570
BANDA-VENT	K100675	BANDA-VENT	2/TR22570PB
POLEA DEL TENSOR-VENT	36092	MANGUERA SILICÓN-TUBO A RAD.	SIH250363C
TENSOR-VENT	38535	MANGUERA SILICÓN-TUBO A RAD.	SIH300363C
MANGUERA SILICÓN-TUBO A RAD.	SIH250363C	MANGUERA SILICÓN-MOTOR A TUBO	SIH250363C
MANGUERA SUPERIOR-TUBO A RAD.	26532	MANGUERA SILICÓN-MOTOR A TUBO	SIH300363C
POLEA DEL TENSOR-TOMA DE FUERZA-ALT-AA	36095	BANDA-ALT-VENT-AA	9650
TENSOR-TOMA DE FUERZA-ALT-AA	38532	TERMOSTATO-190°	33579
MANGUERA SILICÓN-MOTOR A TUBO	SIH250363C	TERMOSTATO-180°	33576
BANDA-ALT-BA-AA	K060685	TERMOSTATO-180°	33578
2001		TERMOSTATO-170°	33577
BANDA-VENT	K100675	2002	
POLEA DEL TENSOR-VENT	36092	BANDA-VENT- OPCIONAL	TR22570
TENSOR-VENT	38535	BANDA-VENT	2/TR22570PB
MANGUERA SILICÓN-TUBO A RAD.	SIH250363C	MANGUERA SILICÓN-TUBO A RAD.	SIH250363C
MANGUERA SUPERIOR-TUBO A RAD.	26532	MANGUERA SUPERIOR-TUBO A RAD.	21115
BANDA-TOMA DE FUERZA-ALT-AA	K060685	MANGUERA SILICÓN-MOTOR A TUBO	SIH250363C
POLEA DEL TENSOR-TOMA DE FUERZA-ALT-AA	36095	MANGUERA SILICÓN-MOTOR A TUBO	SIH300363C
TENSOR-TOMA DE FUERZA-ALT-AA	38532	BANDA-ALT-VENT-AA	9650



MASTER SERVICIO PESADO 2014

KENWORTH

T2000

TERMOSTATO-190°	33579	TAPÓN DE RADIADOR-(15 LBS) SIN PALANCA	31350
TERMOSTATO-180°	33576	BOMBA DE AGUA-	44052HD
TERMOSTATO-180°	33578	2009	
TERMOSTATO-170°	33577	BANDA-VENT-AA	K060637
2001		POLEA DEL TENSOR-VENT-AA	36091
BANDA-VENT- OPCIONAL	TR22570	TENSOR-VENT-AA	38511
BANDA-VENT	2/TR22570PB	MANGUERA SILICÓN-RAD. A TUBO	SIH250363C
MANGUERA INFERIOR-TUBO A RAD.	CHARTER 2 1/2"	MANGUERA SILICÓN-MOTOR A TUBO	SIH250363C
MANGUERA SUPERIOR-TUBO A RAD.	CHARTER 2 1/2"	MANGUERA SILICÓN-MOTOR A TUBO	SIH300363C
MANGUERA INFERIOR-MOTOR A TUBO	CHARTER 2 1/2"	POLEA-MOTOR	36091
MANGUERA SUPERIOR-MOTOR A RAD.	CHARTER 2 1/2"	BANDA-ALT-VENT	K080939
BANDA-ALT-VENT-AA	9560	TENSOR-ALT-VENT	38569
TERMOSTATO-190°	33579	TERMOSTATO-190°	33579
TERMOSTATO-180°	33576	TERMOSTATO-180°	33576
TERMOSTATO-180°	33578	TERMOSTATO-180°	33578
TERMOSTATO-170°	33577	TERMOSTATO-170°	33577
2000		TAPÓN DE RADIADOR-(15 LBS) SIN PALANCA	31350
BANDA-VENT- OPCIONAL	TR22570	BOMBA DE AGUA-	44052HD
BANDA-VENT	2/TR22570PB	2008	
MANGUERA INFERIOR-TUBO A RAD.	CHARTER 2 1/2"	BANDA-VENT-AA	K060637
MANGUERA SUPERIOR-TUBO A RAD.	CHARTER 2 1/2"	POLEA DEL TENSOR-VENT-AA	36091
MANGUERA INFERIOR-MOTOR A TUBO	CHARTER 2 1/2"	TENSOR-VENT-AA	38511
MANGUERA SUPERIOR-MOTOR A RAD.	CHARTER 2 1/2"	MANGUERA SILICÓN-RAD. A TUBO	SIH250363C
BANDA-ALT-VENT-AA	9560	MANGUERA SILICÓN-MOTOR A TUBO	SIH250363C
TERMOSTATO-190°	33579	MANGUERA SILICÓN-MOTOR A TUBO	SIH300363C
TERMOSTATO-180°	33576	POLEA-MOTOR	36091
TERMOSTATO-180°	33578	BANDA-ALT-VENT	K080939
TERMOSTATO-170°	33577	TENSOR-ALT-VENT	38569
CATERPILLAR C15 DIESEL		TERMOSTATO-190°	33579
2010		TERMOSTATO-180°	33576
BANDA-VENT-AA	K060637	TERMOSTATO-180°	33578
POLEA DEL TENSOR-VENT-AA	36091	TERMOSTATO-170°	33577
TENSOR-VENT-AA	38511	TAPÓN DE RADIADOR-(15 LBS) SIN PALANCA	31350
MANGUERA SILICÓN-RAD. A TUBO	SIH250363C	BOMBA DE AGUA-	44052HD
MANGUERA SILICÓN-MOTOR A TUBO	SIH250363C	2007	
MANGUERA SILICÓN-MOTOR A TUBO	SIH300363C	BANDA-VENT-AA	K060637
POLEA-MOTOR	36091	POLEA DEL TENSOR-VENT-AA	36091
BANDA-ALT-VENT	K080939	TENSOR-VENT-AA	38511
TENSOR-ALT-VENT	38569	MANGUERA SILICÓN-RAD. A TUBO	SIH250363C
TERMOSTATO-190°	33579	MANGUERA SILICÓN-MOTOR A TUBO	SIH250363C
TERMOSTATO-180°	33576	MANGUERA SILICÓN-MOTOR A TUBO	SIH300363C
TERMOSTATO-180°	33578	POLEA-MOTOR	36091
TERMOSTATO-170°	33577	BANDA-ALT-VENT	K080939



MASTER SERVICIO PESADO 2014

KENWORTH

T2000

TENSOR-ALT-VENT	38569	MANGUERA SILICÓN-RAD. A TUBO	SIH250363C
TERMOSTATO-190°	33579	MANGUERA SILICÓN-MOTOR A TUBO	SIH250363C
TERMOSTATO-180°	33576	MANGUERA SILICÓN-MOTOR A TUBO	SIH300363C
TERMOSTATO-180°	33578	POLEA-MOTOR	36091
TERMOSTATO-170°	33577	BANDA-ALT-VENT	K080939
TAPÓN DE RADIADOR-(15 LBS) SIN PALANCA	31350	TENSOR-ALT-VENT	38569
BOMBA DE AGUA-	44052HD	TERMOSTATO-190°	33579
2006		TERMOSTATO-180°	33576
BANDA-VENT-AA	K060637	TERMOSTATO-180°	33578
POLEA DEL TENSOR-VENT-AA	36091	TERMOSTATO-170°	33577
TENSOR-VENT-AA	38511	TAPÓN DE RADIADOR-(15 LBS) SIN PALANCA	31350
MANGUERA SILICÓN-RAD. A TUBO	SIH250363C	BOMBA DE AGUA-	44052HD
MANGUERA SILICÓN-MOTOR A TUBO	SIH250363C	2003	
MANGUERA SILICÓN-MOTOR A TUBO	SIH300363C	BANDA-VENT- OPCIONAL	TR22570
POLEA-MOTOR	36091	BANDA-VENT	2/TR22570PB
BANDA-ALT-VENT	K080939	MANGUERA SILICÓN-TUBO A RAD.	SIH250363C
TENSOR-ALT-VENT	38569	MANGUERA SILICÓN-TUBO A RAD.	SIH300363C
TERMOSTATO-190°	33579	MANGUERA SILICÓN-MOTOR A TUBO	SIH250363C
TERMOSTATO-180°	33576	MANGUERA SILICÓN-MOTOR A TUBO	SIH300363C
TERMOSTATO-180°	33578	BANDA-ALT-VENT-AA	9650
TERMOSTATO-170°	33577	TERMOSTATO-190°	33579
TAPÓN DE RADIADOR-(15 LBS) SIN PALANCA	31350	TERMOSTATO-180°	33576
BOMBA DE AGUA-	44052HD	TERMOSTATO-180°	33578
2005		TERMOSTATO-170°	33577
BANDA-VENT-AA	K060637	2002	
POLEA DEL TENSOR-VENT-AA	36091	BANDA-VENT- OPCIONAL	TR22570
TENSOR-VENT-AA	38511	BANDA-VENT	2/TR22570PB
MANGUERA SILICÓN-RAD. A TUBO	SIH250363C	MANGUERA SILICÓN-TUBO A RAD.	SIH250363C
MANGUERA SILICÓN-MOTOR A TUBO	SIH250363C	MANGUERA SUPERIOR-TUBO A RAD.	21115
MANGUERA SILICÓN-MOTOR A TUBO	SIH300363C	MANGUERA SILICÓN-MOTOR A TUBO	SIH250363C
POLEA-MOTOR	36091	MANGUERA SILICÓN-MOTOR A TUBO	SIH300363C
BANDA-ALT-VENT	K080939	BANDA-ALT-VENT-AA	9650
TENSOR-ALT-VENT	38569	TERMOSTATO-190°	33579
TERMOSTATO-190°	33579	TERMOSTATO-180°	33576
TERMOSTATO-180°	33576	TERMOSTATO-180°	33578
TERMOSTATO-180°	33578	TERMOSTATO-170°	33577
TERMOSTATO-170°	33577	2001	
TAPÓN DE RADIADOR-(15 LBS) SIN PALANCA	31350	BANDA-VENT- OPCIONAL	TR22570
BOMBA DE AGUA-	44052HD	BANDA-VENT	2/TR22570PB
2004		MANGUERA INFERIOR-TUBO A RAD.	CHARTER 2 1/2"
BANDA-VENT-AA	K060637	MANGUERA SUPERIOR-TUBO A RAD.	CHARTER 2 1/2"
POLEA DEL TENSOR-VENT-AA	36091	MANGUERA INFERIOR-MOTOR A TUBO	CHARTER 2 1/2"
TENSOR-VENT-AA	38511	MANGUERA SUPERIOR-MOTOR A RAD.	CHARTER 2 1/2"



MASTER SERVICIO PESADO 2014

KENWORTH

T2000

BANDA-ALT-VENT-AA	9560	TERMOSTATO-180°	33578
TERMOSTATO-190°	33579	TERMOSTATO-170°	33577
TERMOSTATO-180°	33576	TAPÓN DE RADIADOR-(15 LBS) SIN PALANCA	31350
TERMOSTATO-180°	33578	2004	
TERMOSTATO-170°	33577	TAPÓN DE RADIADOR-(15 LBS) SIN PALANCA	31350
2000		CATERPILLAR C12 DIESEL	
BANDA-VENT- OPCIONAL	TR22570	2004	
BANDA-VENT	2/TR22570PB	TERMOSTATO-190°	33579
MANGUERA INFERIOR-TUBO A RAD.	CHARTER 2 1/2"	TERMOSTATO-180°	33576
MANGUERA SUPERIOR-TUBO A RAD.	CHARTER 2 1/2"	TERMOSTATO-180°	33578
MANGUERA INFERIOR-MOTOR A TUBO	CHARTER 2 1/2"	TERMOSTATO-170°	33577
MANGUERA SUPERIOR-MOTOR A RAD.	CHARTER 2 1/2"	2003	
BANDA-ALT-VENT-AA	9560	TERMOSTATO-190°	33579
TERMOSTATO-190°	33579	TERMOSTATO-180°	33576
TERMOSTATO-180°	33576	TERMOSTATO-180°	33578
TERMOSTATO-180°	33578	TERMOSTATO-170°	33577
TERMOSTATO-170°	33577	2002	
CATERPILLAR C13 DIESEL		TERMOSTATO-190°	33579
2010		TERMOSTATO-180°	33576
TAPÓN DE RADIADOR-(15 LBS) SIN PALANCA	31350	TERMOSTATO-180°	33578
2009		TERMOSTATO-170°	33577
TAPÓN DE RADIADOR-(15 LBS) SIN PALANCA	31350	2001	
2008		TERMOSTATO-190°	33579
TERMOSTATO-190°	33579	TERMOSTATO-180°	33576
TERMOSTATO-180°	33576	TERMOSTATO-180°	33578
TERMOSTATO-180°	33578	TERMOSTATO-170°	33577
TERMOSTATO-170°	33577	2000	
TAPÓN DE RADIADOR-(15 LBS) SIN PALANCA	31350	TERMOSTATO-190°	33579
2007		TERMOSTATO-180°	33576
TERMOSTATO-190°	33579	TERMOSTATO-180°	33578
TERMOSTATO-180°	33576	TERMOSTATO-170°	33577
TERMOSTATO-180°	33578	1999	
TERMOSTATO-170°	33577	BANDA-ALT-VENT	K080645
TAPÓN DE RADIADOR-(15 LBS) SIN PALANCA	31350	SENSOR-ALT-VENT	38505
2006		TERMOSTATO-190°	33579
TERMOSTATO-190°	33579	TERMOSTATO-180°	33576
TERMOSTATO-180°	33576	TERMOSTATO-180°	33578
TERMOSTATO-180°	33578	TERMOSTATO-170°	33577
TERMOSTATO-170°	33577	BANDA-	9520
TAPÓN DE RADIADOR-(15 LBS) SIN PALANCA	31350	POLEA DEL SENSOR-	36091
2005		1998	
TERMOSTATO-190°	33579	BANDA-ALT-VENT	K080645
TERMOSTATO-180°	33576	SENSOR-ALT-VENT	38505



TERMOSTATO-190°	33579	TERMOSTATO-180°	33578
TERMOSTATO-180°	33576	TERMOSTATO-170°	33577
TERMOSTATO-180°	33578	BANDA-	9525
TERMOSTATO-170°	33577	MANGUERA SILICÓN-	SIH250363C
BANDA-	9520	POLEA DEL TENSOR-	36091
POLEA DEL TENSOR-	36091	CATERPILLAR 3406 DIESEL	
1997		2000	
MANGUERA SILICÓN-TUBO A RAD.	SIH300363C	BANDA-VENT- OPCIONAL	TR22570
MANGUERA SUPERIOR FLEXIBLE-TUBO A RAD.	25T140 GS	BANDA-VENT	2/TR22570PB
MANGUERA SILICÓN-MOTOR A TUBO	SIH250363C	MANGUERA SILICÓN-TUBO A RAD.	SIH250363C
BANDA-ALT-VENT	K080645	MANGUERA SUPERIOR-TUBO A RAD.	21891
TERMOSTATO-190°	33579	MANGUERA INFERIOR-MOTOR A TUBO	24452
TERMOSTATO-180°	33576	MANGUERA SILICÓN-MOTOR A TUBO	SIH250363C
TERMOSTATO-180°	33578	BANDA-ALT-VENT-AA	9650
TERMOSTATO-170°	33577	TERMOSTATO-190°	33579
BANDA-	9525	TERMOSTATO-180°	33576
POLEA DEL TENSOR-	36091	TERMOSTATO-180°	33578
CATERPILLAR C10 DIESEL		TERMOSTATO-170°	33577
1999		1999	
BANDA-ALT-VENT	K080645	BANDA-VENT- OPCIONAL	TR22570
TENSOR-ALT-VENT	38505	BANDA-VENT	2/TR22570PB
TERMOSTATO-190°	33579	MANGUERA SILICÓN-TUBO A RAD.	SIH250363C
TERMOSTATO-180°	33576	MANGUERA SUPERIOR-TUBO A RAD.	21115
TERMOSTATO-180°	33578	MANGUERA SILICÓN-MOTOR A TUBO	SIH250363C
TERMOSTATO-170°	33577	MANGUERA SILICÓN-MOTOR A TUBO	SIH300363C
BANDA-	9520	BANDA-ALT-AA	2/9640PB
POLEA DEL TENSOR-	36091	BANDA-ALT-AA	9640
1998		TERMOSTATO-190°	33579
BANDA-ALT-VENT	K080645	TERMOSTATO-180°	33576
TENSOR-ALT-VENT	38505	TERMOSTATO-180°	33578
TERMOSTATO-190°	33579	TERMOSTATO-170°	33577
TERMOSTATO-180°	33576	1998	
TERMOSTATO-180°	33578	BANDA-VENT- OPCIONAL	TR22570
TERMOSTATO-170°	33577	BANDA-VENT	2/TR22570PB
BANDA-	9520	MANGUERA SILICÓN-TUBO A RAD.	SIH250363C
POLEA DEL TENSOR-	36091	MANGUERA SUPERIOR-TUBO A RAD.	21115
1997		MANGUERA SILICÓN-MOTOR A TUBO	SIH250363C
MANGUERA SILICÓN-TUBO A RAD.	SIH300363C	MANGUERA SILICÓN-MOTOR A TUBO	SIH300363C
MANGUERA SILICÓN-MOTOR A TUBO	SIH250363C	BANDA-ALT-AA	2/9640PB
BANDA-ALT-VENT	K080645	BANDA-ALT-AA	9640
TENSOR-ALT-VENT	38505	TERMOSTATO-190°	33579
TERMOSTATO-190°	33579	TERMOSTATO-180°	33576
TERMOSTATO-180°	33576	TERMOSTATO-180°	33578



MASTER SERVICIO PESADO 2014

KENWORTH

T2000

TERMOSTATO-170°	33577	BANDA-ALT-VENT-AA	K080868
1997		TAPÓN DE RADIADOR-(15 LBS) SIN PALANCA	31350
BANDA-VENT- OPCIONAL	TR22570	CUMMINS ISC DIESEL	
BANDA-VENT	2/TR22570PB	2008	
MANGUERA SILICÓN-TUBO A RAD.	SIH250363C	BANDA-S/AA	K080878
MANGUERA SUPERIOR-TUBO A RAD.	21115	MANGUERA SILICÓN-RAD. A TUBO	SIH250363C
MANGUERA SILICÓN-MOTOR A TUBO	SIH250363C	MANGUERA SILICÓN-MOTOR A TUBO	SIH250363C
MANGUERA SILICÓN-MOTOR A TUBO	SIH300363C	MANGUERA INFERIOR-MOTOR A RAD.	24436
BANDA-ALT-AA	2/9640PB	POLEA-MOTOR	36283
BANDA-ALT-AA	9640	TENSOR-MOTOR	38516
TERMOSTATO-190°	33579	BANDA-C/AA	K080956
TERMOSTATO-180°	33576	TERMOSTATO-180°-C/DOBLE TERMOSTATO	33966
TERMOSTATO-180°	33578	TERMOSTATO-180°	33959
TERMOSTATO-170°	33577	TAPÓN DE RADIADOR-(15 LBS) SIN PALANCA	31350
T300		BOMBA DE AGUA-	42146HD
PACCAR PX-6 DIESEL		2007	
2010		BANDA-S/AA	K080878
MANGUERA SILICÓN-RAD. A TUBO	SIH250363C	MANGUERA SILICÓN-RAD. A TUBO	SIH250363C
MANGUERA SILICÓN-MOTOR A TUBO	SIH175363C	MANGUERA SILICÓN-MOTOR A TUBO	SIH250363C
TENSOR-MOTOR	38631	MANGUERA INFERIOR-MOTOR A RAD.	24436
BANDA-ALT-VENT-AA (OPCIÓN 2)	K080855	POLEA-MOTOR	36283
BANDA-ALT-VENT-AA (OPCIÓN 1)	K080868	TENSOR-MOTOR	38516
BANDA-ALT-VENT-AA	K080868	BANDA-C/AA	K080956
TAPÓN DE RADIADOR-(15 LBS) SIN PALANCA	31350	TERMOSTATO-180°-C/DOBLE TERMOSTATO	33966
2009		TERMOSTATO-180°	33959
MANGUERA SILICÓN-RAD. A TUBO	SIH250363C	TAPÓN DE RADIADOR-(15 LBS) SIN PALANCA	31350
MANGUERA SILICÓN-MOTOR A TUBO	SIH175363C	BOMBA DE AGUA-	42146HD
TENSOR-MOTOR	38631	2006	
BANDA-ALT-VENT-AA (OPCIÓN 2)	K080855	MANGUERA SUPERIOR-RAD. A TUBO	24436
BANDA-ALT-VENT-AA (OPCIÓN 1)	K080868	MANGUERA SUPERIOR-MOTOR A TUBO	24436
BANDA-ALT-VENT-AA	K080868	POLEA-MOTOR	36283
TAPÓN DE RADIADOR-(15 LBS) SIN PALANCA	31350	TENSOR-MOTOR	38516
2008		BANDA-ALT-VENT-AA	K080878
MANGUERA SILICÓN-RAD. A TUBO	SIH250363C	TENSOR-ALT-VENT-AA	38516
MANGUERA SILICÓN-MOTOR A TUBO	SIH175363C	TERMOSTATO-180°-C/DOBLE TERMOSTATO	33966
TENSOR-MOTOR	38631	TERMOSTATO-180°	33959
BANDA-ALT-VENT-AA (OPCIÓN 2)	K080855	TAPÓN DE RADIADOR-(15 LBS) SIN PALANCA	31350
BANDA-ALT-VENT-AA (OPCIÓN 1)	K080868	BOMBA DE AGUA-	42146HD
BANDA-ALT-VENT-AA	K080868	2005	
TAPÓN DE RADIADOR-(15 LBS) SIN PALANCA	31350	BANDA-VENT-AA	6420 GS
2007		MANGUERA INFERIOR-MOTOR A TUBO	24236
MANGUERA SILICÓN-RAD. A TUBO	SIH250363C	MANGUERA INFERIOR-MOTOR A TUBO	24240
MANGUERA SILICÓN-MOTOR A TUBO	SIH175363C	MANGUERA SUPERIOR-MOTOR A TUBO	24236
TENSOR-MOTOR	38631		



MASTER SERVICIO PESADO 2014

KENWORTH

T300

MANGUERA SILICÓN-ENFRIADOR A TUBO	SIH250363C	2000	
BANDA-ALT-VENT	K080720	BANDA-VENT-AA	6420 GS
TENSOR-ALT-VENT	38516	MANGUERA SUPERIOR-TUBO A RAD.	21115
TERMOSTATO-180°-C/DOBLE TERMOSTATO	33966	BANDA-TOMA DE FUERZA-ALT-VENT	K080745
TERMOSTATO-180°	33959	POLEA DEL TENSOR-TOMA DE FUERZA-ALT-VENT	36093
TAPÓN DE RADIADOR-(15 LBS) SIN PALANCA	31350	TENSOR-TOMA DE FUERZA-ALT-VENT	38516
BOMBA DE AGUA-	42146HD	MANGUERA SUPERIOR-MOTOR A TUBO	24436
2004		TERMOSTATO-180°-C/DOBLE TERMOSTATO	33966
BANDA-VENT-AA	6420 GS	TERMOSTATO-180°	33959
MANGUERA SUPERIOR-TUBO A RAD.	21115	1999	
BANDA-TOMA DE FUERZA-ALT-VENT	K080745	BANDA-VENT-AA	6420 GS
POLEA DEL TENSOR-TOMA DE FUERZA-ALT-VENT	36093	MANGUERA SUPERIOR-TUBO A RAD.	21115
TENSOR-TOMA DE FUERZA-ALT-VENT	38516	BANDA-TOMA DE FUERZA-ALT-VENT	K080745
MANGUERA SUPERIOR-MOTOR A TUBO	24436	POLEA DEL TENSOR-TOMA DE FUERZA-ALT-VENT	36093
TERMOSTATO-180°-C/DOBLE TERMOSTATO	33966	TENSOR-TOMA DE FUERZA-ALT-VENT	38516
TERMOSTATO-180°	33959	MANGUERA SUPERIOR-MOTOR A TUBO	24436
2003		TERMOSTATO-180°-C/DOBLE TERMOSTATO	33966
BANDA-VENT-AA	6420 GS	TERMOSTATO-180°	33959
MANGUERA SUPERIOR-TUBO A RAD.	21115	1998	
BANDA-TOMA DE FUERZA-ALT-VENT	K080745	BANDA-VENT-AA	6420 GS
POLEA DEL TENSOR-TOMA DE FUERZA-ALT-VENT	36093	MANGUERA SUPERIOR-TUBO A RAD.	21115
TENSOR-TOMA DE FUERZA-ALT-VENT	38516	BANDA-TOMA DE FUERZA-ALT-VENT	K080745
MANGUERA SUPERIOR-MOTOR A TUBO	24436	POLEA DEL TENSOR-TOMA DE FUERZA-ALT-VENT	36093
TERMOSTATO-180°-C/DOBLE TERMOSTATO	33966	TENSOR-TOMA DE FUERZA-ALT-VENT	38516
TERMOSTATO-180°	33959	MANGUERA SUPERIOR-MOTOR A TUBO	24436
2002		TERMOSTATO-180°-C/DOBLE TERMOSTATO	33966
BANDA-VENT-AA	6420 GS	TERMOSTATO-180°	33959
MANGUERA SUPERIOR-TUBO A RAD.	21115	CUMMINS C Series 8.3 L DIESEL	
BANDA-TOMA DE FUERZA-ALT-VENT	K080745	1997	
POLEA DEL TENSOR-TOMA DE FUERZA-ALT-VENT	36093	BANDA-MOTOR	K081020
TENSOR-TOMA DE FUERZA-ALT-VENT	38516	TERMOSTATO-180°-C/DOBLE TERMOSTATO	33966
MANGUERA SUPERIOR-MOTOR A TUBO	24436	TERMOSTATO-180°	33959
TERMOSTATO-180°-C/DOBLE TERMOSTATO	33966	1996	
TERMOSTATO-180°	33959	BANDA-MOTOR	K081020
2001		TERMOSTATO-180°-C/DOBLE TERMOSTATO	33966
BANDA-VENT-AA	6420 GS	TERMOSTATO-180°	33959
MANGUERA SUPERIOR-TUBO A RAD.	21115	1995	
BANDA-TOMA DE FUERZA-ALT-VENT	K080745	TERMOSTATO-180°-C/DOBLE TERMOSTATO	33966
POLEA DEL TENSOR-TOMA DE FUERZA-ALT-VENT	36093	TERMOSTATO-180°	33959
TENSOR-TOMA DE FUERZA-ALT-VENT	38516	CATERPILLAR C7 DIESEL	
MANGUERA SUPERIOR-MOTOR A TUBO	24436	2007	
TERMOSTATO-180°-C/DOBLE TERMOSTATO	33966	MANGUERA SUPERIOR-RAD. A TUBO	21194
TERMOSTATO-180°	33959	MANGUERA SUPERIOR-MOTOR A TUBO	20206



MASTER SERVICIO PESADO 2014

KENWORTH

T300

BANDA-ALT-VENT-AA	K080810	TERMOSTATO-190°	33969
TENSOR-ALT-VENT-AA	38586	TERMOSTATO-180°	33968
TERMOSTATO-190°	33969	2002	
TERMOSTATO-180°	33968	MANGUERA SILICÓN-TUBO A TUBO	SIH250363C
POLEA-	36096	MANGUERA INFERIOR-TUBO A RAD.	22707
2006		MANGUERA SUPERIOR-TUBO A RAD.	21115
MANGUERA SUPERIOR-RAD. A TUBO	21194	MANGUERA SILICÓN-MOTOR A TUBO	SIH200363C
MANGUERA SUPERIOR-MOTOR A TUBO	20206	MANGUERA SUPERIOR-MOTOR A TUBO	21891
POLEA-MOTOR	36091	BANDA-BA	9341
BANDA-ALT-VENT-AA	K080810	BANDA-ALT-VENT-AA	K080774
TENSOR-ALT-VENT-AA	38586	TENSOR-ALT-VENT-AA	38511
TERMOSTATO-190°	33969	POLEA DEL TENSOR-ALT-BA-VENT	36091
TERMOSTATO-180°	33968	TERMOSTATO-190°	33969
POLEA-	36096	TERMOSTATO-180°	33968
2005		2001	
MANGUERA SUPERIOR-RAD. A TUBO	21194	MANGUERA SILICÓN-TUBO A TUBO	SIH250363C
MANGUERA SUPERIOR-MOTOR A TUBO	20206	MANGUERA INFERIOR-TUBO A RAD.	22707
POLEA-MOTOR	36091	MANGUERA SUPERIOR-TUBO A RAD.	21115
BANDA-ALT-VENT-AA	K080859	MANGUERA SILICÓN-MOTOR A TUBO	SIH200363C
TENSOR-ALT-VENT-AA	38586	MANGUERA SUPERIOR-MOTOR A TUBO	21891
TERMOSTATO-190°	33969	BANDA-BA	9341
TERMOSTATO-180°	33968	BANDA-ALT-VENT-AA	K080774
POLEA-	36096	TENSOR-ALT-VENT-AA	38511
2004		POLEA DEL TENSOR-ALT-BA-VENT	36091
MANGUERA SUPERIOR-RAD. A RAD.	20611	TERMOSTATO-190°	33969
MANGUERA SUPERIOR-MOTOR A RAD.	20206	TERMOSTATO-180°	33968
POLEA-MOTOR	36091	2000	
BANDA-ALT-VENT-AA	K080810	MANGUERA SILICÓN-TUBO A TUBO	SIH250363C
TENSOR-ALT-VENT-AA	38586	MANGUERA INFERIOR-TUBO A RAD.	22707
TERMOSTATO-190°	33969	MANGUERA INFERIOR FLEXIBLE-TUBO A RAD.	25T160 GS
TERMOSTATO-180°	33968	MANGUERA SUPERIOR-TUBO A RAD.	21115
POLEA-	36096	MANGUERA SILICÓN-MOTOR A TUBO	SIH200363C
CATERPILLAR 3126 DIESEL		MANGUERA SUPERIOR-MOTOR A TUBO	21891
2003		BANDA-BA	9341
MANGUERA SILICÓN-TUBO A TUBO	SIH250363C	BANDA-ALT-VENT-AA	K080774
MANGUERA INFERIOR-TUBO A RAD.	22707	TENSOR-ALT-VENT-AA	38511
MANGUERA SUPERIOR-TUBO A RAD.	21115	POLEA DEL TENSOR-ALT-BA-VENT	36091
MANGUERA SILICÓN-MOTOR A TUBO	SIH200363C	TERMOSTATO-190°	33969
MANGUERA SUPERIOR-MOTOR A TUBO	21891	TERMOSTATO-180°	33968
BANDA-BA	9341	1999	
BANDA-ALT-VENT-AA	K080774	MANGUERA SILICÓN-TUBO A TUBO	SIH250363C
TENSOR-ALT-VENT-AA	38511	MANGUERA INFERIOR-TUBO A RAD.	22707
POLEA DEL TENSOR-ALT-BA-VENT	36091	MANGUERA SUPERIOR-TUBO A RAD.	21115



MASTER SERVICIO PESADO 2014

KENWORTH

T300

MANGUERA SILICÓN-MOTOR A TUBO	SIH200363C	TERMOSTATO-180°	33968
MANGUERA SUPERIOR-MOTOR A TUBO	21891	T370	
BANDA-BA	9341	PACCAR PX-6	
BANDA-ALT-VENT-AA	K080774	2013	
SENSOR-ALT-VENT-AA	38511	BANDA-VENT	K080825
POLEA DEL TENSOR-ALT-BA-VENT	36091	TAPÓN DE RADIADOR-(15 LBS) SIN PALANCA	31350
TERMOSTATO-190°	33969	MANGUERA SILICÓN-	SIH175363C
TERMOSTATO-180°	33968	MANGUERA SILICÓN-	SIH200363C
1998		MANGUERA SILICÓN-	SIH250363C
MANGUERA SILICÓN-TUBO A TUBO	SIH250363C	2012	
MANGUERA INFERIOR-TUBO A RAD.	22707	BANDA-VENT	K080825
MANGUERA SUPERIOR-TUBO A RAD.	21115	TAPÓN DE RADIADOR-(15 LBS) SIN PALANCA	31350
MANGUERA SILICÓN-MOTOR A TUBO	SIH200363C	MANGUERA SILICÓN-	SIH175363C
MANGUERA SUPERIOR-MOTOR A TUBO	21891	MANGUERA SILICÓN-	SIH200363C
BANDA-BA	9341	MANGUERA SILICÓN-	SIH250363C
BANDA-ALT-VENT-AA	K080774	2011	
SENSOR-ALT-VENT-AA	38511	TENSOR-MOTOR	38631
POLEA DEL TENSOR-ALT-BA-VENT	36091	BANDA-ALT-VENT-AA (OPCIÓN 2)	K080868
TERMOSTATO-190°	33969	BANDA-ALT-VENT-AA (OPCIÓN 1)	K080855
TERMOSTATO-180°	33968	TAPÓN DE RADIADOR-(15 LBS) SIN PALANCA	31350
1997		MANGUERA SILICÓN-	SIH175363C
MANGUERA SILICÓN-TUBO A TUBO	SIH250363C	MANGUERA SILICÓN-	SIH250363C
MANGUERA INFERIOR-TUBO A RAD.	22707	2010	
MANGUERA SUPERIOR-TUBO A RAD.	21115	TENSOR-MOTOR	38631
MANGUERA SILICÓN-MOTOR A TUBO	SIH200363C	BANDA-ALT-VENT-AA (OPCIÓN 2)	K080868
MANGUERA SUPERIOR-MOTOR A TUBO	21891	BANDA-ALT-VENT-AA (OPCIÓN 1)	K080855
BANDA-BA	9341	TAPÓN DE RADIADOR-(15 LBS) SIN PALANCA	31350
BANDA-ALT-VENT	K080774	MANGUERA SILICÓN-	SIH175363C
TENSOR-ALT-VENT	38511	MANGUERA SILICÓN-	SIH250363C
POLEA DEL TENSOR-ALT-BA-VENT	36091	2009	
TERMOSTATO-190°	33969	TENSOR-MOTOR	38631
TERMOSTATO-180°	33968	BANDA-ALT-VENT-AA (OPCIÓN 2)	K080868
1996		BANDA-ALT-VENT-AA (OPCIÓN 1)	K080855
MANGUERA SILICÓN-TUBO A TUBO	SIH250363C	TAPÓN DE RADIADOR-(15 LBS) SIN PALANCA	31350
MANGUERA INFERIOR-TUBO A RAD.	22707	MANGUERA SILICÓN-	SIH175363C
MANGUERA SUPERIOR-TUBO A RAD.	21115	MANGUERA SILICÓN-	SIH250363C
MANGUERA SILICÓN-MOTOR A TUBO	SIH200363C	T400	
MANGUERA SUPERIOR-MOTOR A TUBO	21891	CUMMINS M11 DIESEL	
BANDA-BA	9341	1998	
BANDA-ALT-VENT	K080774	TERMOSTATO-190°	33579
TENSOR-ALT-VENT	38511	TERMOSTATO-180°	33576
POLEA DEL TENSOR-ALT-BA-VENT	36091	TERMOSTATO-180°	33578
TERMOSTATO-190°	33969	TERMOSTATO-170°	33577



1997		TERMOSTATO-175°	33960
BANDA-VENT	K080485	TERMOSTATO-170°	33577
BANDA-ALT	K050345	BANDA-	9530
BANDA-AA	PQ17530	BANDA-	9560
TERMOSTATO-190°	33579	1996	
TERMOSTATO-180°	33576	BANDA-VENT	K080465
TERMOSTATO-180°	33578	BANDA-VENT	K080485
TERMOSTATO-170°	33577	BANDA-ALT	K050340
BANDA-	9530	BANDA-ALT	K050350
1996		BANDA-AA	8563 GS
BANDA-VENT	K080485	BANDA-AA	PQ17530
BANDA-ALT	K050345	TERMOSTATO-190°	33579
BANDA-AA	PQ17530	TERMOSTATO-180°	33576
TERMOSTATO-190°	33579	TERMOSTATO-180°	33578
TERMOSTATO-180°	33576	TERMOSTATO-175°	33960
TERMOSTATO-180°	33578	TERMOSTATO-170°	33577
TERMOSTATO-170°	33577	BANDA-	9530
BANDA-	9530	BANDA-	9560
1995		1995	
BANDA-VENT	K080485	BANDA-VENT	K080465
BANDA-ALT	K050345	BANDA-VENT	K080485
BANDA-AA	PQ17530	BANDA-ALT	K050340
TERMOSTATO-190°	33579	BANDA-ALT	K050350
TERMOSTATO-180°	33576	BANDA-AA	8563 GS
TERMOSTATO-180°	33578	BANDA-AA	PQ17530
TERMOSTATO-170°	33577	TERMOSTATO-190°	33579
BANDA-	9530	TERMOSTATO-180°	33576
1994		TERMOSTATO-180°	33578
TERMOSTATO-190°	33579	TERMOSTATO-175°	33960
TERMOSTATO-180°	33576	TERMOSTATO-170°	33577
TERMOSTATO-180°	33578	BANDA-	9530
TERMOSTATO-170°	33577	BANDA-	9560
CUMMINS L10 DIESEL			
1997		1994	
BANDA-VENT	K080465	BANDA-VENT	K080465
BANDA-VENT	K080485	BANDA-VENT	K080485
BANDA-ALT	K050340	MANGUERA SILICÓN-TUBO A RAD.	SIH250363C
BANDA-ALT	K050350	MANGUERA SILICÓN-TUBO A RAD.	SIH300363C
BANDA-AA	8563 GS	MANGUERA SUPERIOR-TUBO A RAD.	CHARTER 2 1/2"
BANDA-AA	PQ17530	MANGUERA SILICÓN-MOTOR A TUBO	SIH250363C
TERMOSTATO-190°	33579	MANGUERA SUPERIOR-MOTOR A TUBO	24436
TERMOSTATO-180°	33576	MANGUERA SUPERIOR-MOTOR A TUBO	CHARTER 2 1/4"
TERMOSTATO-180°	33578	BANDA-ALT	K050340
		BANDA-ALT	K050350



MASTER SERVICIO PESADO 2014

KENWORTH

T400

BANDA-AA	8563 GS	BANDA-VENT	K080485
BANDA-AA	PQ17530	MANGUERA SILICÓN-TUBO A RAD.	SIH250363C
TERMOSTATO-190°	33579	MANGUERA SILICÓN-TUBO A RAD.	SIH300363C
TERMOSTATO-180°	33576	MANGUERA SUPERIOR-TUBO A RAD.	CHARTER 2 1/2"
TERMOSTATO-180°	33578	MANGUERA SILICÓN-MOTOR A TUBO	SIH250363C
TERMOSTATO-175°	33960	MANGUERA SUPERIOR-MOTOR A TUBO	24436
TERMOSTATO-170°	33577	MANGUERA SUPERIOR-MOTOR A TUBO	CHARTER 2 1/4"
BANDA-	9530	BANDA-ALT	K050340
BANDA-	9560	BANDA-ALT	K050350
MANGUERA DE AGUA-	30T 5/8"	BANDA-AA	8563 GS
MANGUERA DE CALEFACCIÓN-	35B 5/8"	BANDA-AA	PQ17530
MANGUERA INFERIOR-	CHARTER 1 1/4"	BANDA-AA	PQ17550
MANGUERA INFERIOR-	CHARTER 2 1/2"	TERMOSTATO-190°	33579
MANGUERA INFERIOR-	CHARTER 3"	TERMOSTATO-180°	33576
1993		TERMOSTATO-180°	33578
BANDA-VENT	K080465	TERMOSTATO-175°	33960
BANDA-VENT	K080485	TERMOSTATO-170°	33577
MANGUERA SILICÓN-TUBO A RAD.	SIH250363C	BANDA-	9530
MANGUERA SILICÓN-TUBO A RAD.	SIH300363C	BANDA-	9560
MANGUERA SUPERIOR-TUBO A RAD.	CHARTER 2 1/2"	MANGUERA DE AGUA-	30T 5/8"
MANGUERA SILICÓN-MOTOR A TUBO	SIH250363C	MANGUERA DE CALEFACCIÓN-	35B 5/8"
MANGUERA SUPERIOR-MOTOR A TUBO	24436	MANGUERA INFERIOR-	CHARTER 1 1/4"
MANGUERA SUPERIOR-MOTOR A TUBO	CHARTER 2 1/4"	MANGUERA INFERIOR-	CHARTER 2 1/2"
BANDA-ALT	K050340	MANGUERA INFERIOR-	CHARTER 3"
BANDA-ALT	K050350	1991	
BANDA-AA	8563 GS	BANDA-VENT	K080465
BANDA-AA	PQ17530	BANDA-VENT	K080485
BANDA-AA	PQ17550	MANGUERA SILICÓN-TUBO A RAD.	SIH250363C
TERMOSTATO-190°	33579	MANGUERA SILICÓN-TUBO A RAD.	SIH300363C
TERMOSTATO-180°	33576	MANGUERA SUPERIOR-TUBO A RAD.	CHARTER 2 1/2"
TERMOSTATO-180°	33578	MANGUERA SILICÓN-MOTOR A TUBO	SIH250363C
TERMOSTATO-175°	33960	MANGUERA SUPERIOR-MOTOR A TUBO	24436
TERMOSTATO-170°	33577	MANGUERA SUPERIOR-MOTOR A TUBO	CHARTER 2 1/4"
BANDA-	9530	BANDA-ALT	K050340
BANDA-	9560	BANDA-ALT	K050350
MANGUERA DE AGUA-	30T 5/8"	BANDA-AA	8563 GS
MANGUERA DE CALEFACCIÓN-	35B 5/8"	BANDA-AA	PQ17530
MANGUERA INFERIOR-	CHARTER 1 1/4"	BANDA-AA	PQ17550
MANGUERA INFERIOR-	CHARTER 2 1/2"	TERMOSTATO-190°	33579
MANGUERA INFERIOR-	CHARTER 3"	TERMOSTATO-180°	33576
1992		TERMOSTATO-180°	33578
BANDA-VENT	K080465	TERMOSTATO-175°	33960



MASTER SERVICIO PESADO 2014

KENWORTH

T400

TERMOSTATO-170°	33577	BANDA-ALT-AA	2/9570PB
BANDA-	9530	BANDA-ALT-AA	9570
BANDA-	9560	TERMOSTATO-175°	33549
MANGUERA DE AGUA-	30T 5/8"	MANGUERA DE AGUA-	30T 5/8"
MANGUERA DE CALEFACCIÓN-	35B 5/8"	MANGUERA SILICÓN-	SIH250363C
MANGUERA INFERIOR-	CHARTER 1 1/4"	1990	
MANGUERA INFERIOR-	CHARTER 2 1/2"	BANDA-VENT	PQ17500
MANGUERA INFERIOR-	CHARTER 3"	BANDA-ALT-AA	2/9570PB
1990		BANDA-ALT-AA	9570
BANDA-VENT	K080465	TERMOSTATO-175°	33549
BANDA-VENT	K080485	MANGUERA DE CALEFACCIÓN-	35B 5/8"
MANGUERA SUPERIOR-TUBO A RAD.	CHARTER 2 1/2"	MANGUERA INFERIOR-	CHARTER 2 1/2"
MANGUERA SUPERIOR-MOTOR A TUBO	CHARTER 2 1/4"	MANGUERA SUPERIOR-	CHARTER 2 1/2"
BANDA-ALT	K050340	CATERPILLAR 3176 DIESEL	
BANDA-ALT	K050350	1995	
BANDA-AA	8563 GS	BANDA-ALT-VENT	K080675
BANDA-AA	PQ17530	BANDA-ALT-VENT	K080680
BANDA-AA	PQ17550	BANDA-ALT-VENT	K080700
TERMOSTATO-175°	33960	TERMOSTATO-190°	33579
MANGUERA DE CALEFACCIÓN-	35B 5/8"	TERMOSTATO-180°	33576
MANGUERA INFERIOR-	CHARTER 1 1/4"	TERMOSTATO-180°	33578
MANGUERA INFERIOR-	CHARTER 2 1/2"	TERMOSTATO-170°	33577
MANGUERA INFERIOR-	CHARTER 3"	BANDA-	9505
CATERPILLAR 3306 DIESEL		BANDA-	9540
1997		BANDA-	9560
TERMOSTATO-175°	33549	1994	
1996		BANDA-ALT-VENT	K080675
TERMOSTATO-175°	33549	BANDA-ALT-VENT	K080680
1995		BANDA-ALT-VENT	K080700
TERMOSTATO-175°	33549	TERMOSTATO-190°	33579
1994		TERMOSTATO-180°	33576
TERMOSTATO-175°	33549	TERMOSTATO-180°	33578
1993		TERMOSTATO-170°	33577
TERMOSTATO-175°	33549	BANDA-	9505
1992		BANDA-	9540
BANDA-VENT	9495	BANDA-	9560
BANDA-ALT-AA	2/9570PB	1993	
BANDA-ALT-AA	9570	MANGUERA SILICÓN-TUBO A TUBO	SIH250363C
TERMOSTATO-175°	33549	MANGUERA SILICÓN-TUBO A RAD.	SIH300363C
MANGUERA DE AGUA-	30T 5/8"	MANGUERA INFERIOR-MOTOR A TUBO	24436
MANGUERA SILICÓN-	SIH250363C	MANGUERA SILICÓN-MOTOR A TUBO	SIH200363C
1991		BANDA-ALT-VENT	K080675
BANDA-VENT	9495	BANDA-ALT-VENT	K080680



MASTER SERVICIO PESADO 2014

KENWORTH

T400

BANDA-ALT-VENT	K080700	MANGUERA DE AGUA-	30T 5/8"
TERMOSTATO-190°	33579	MANGUERA DE CALEFACCIÓN-	CHARTER 1"
TERMOSTATO-180°	33576	T400A	
TERMOSTATO-180°	33578	CUMMINS M11 DIESEL	
TERMOSTATO-170°	33577	1995	
BANDA-	9505	BANDA-VENT	K080465
BANDA-	9540	BANDA-VENT	K080485
BANDA-	9560	BANDA-COMPRESOR	PQ17530
MANGUERA DE AGUA-	30T 5/8"	BANDA-ALT	K050340
MANGUERA DE CALEFACCIÓN-	CHARTER 1"	BANDA-ALT	K050350
1992		BANDA-AA	8563 GS
MANGUERA INFERIOR-TUBO A RAD.	24436	1994	
MANGUERA SILICÓN-TUBO A RAD.	SIH250363C	BANDA-VENT	K080465
MANGUERA INFERIOR-MOTOR A TUBO	24436	BANDA-VENT	K080485
MANGUERA SILICÓN-MOTOR A TUBO	SIH200363C	BANDA-COMPRESOR	PQ17530
BANDA-ALT-VENT	K080675	BANDA-ALT	K050340
BANDA-ALT-VENT	K080680	BANDA-ALT	K050350
BANDA-ALT-VENT	K080700	BANDA-AA	8563 GS
TERMOSTATO-190°	33579	CUMMINS L10 DIESEL	
TERMOSTATO-180°	33576	1995	
TERMOSTATO-180°	33578	BANDA-VENT	K080465
TERMOSTATO-170°	33577	BANDA-VENT	K080485
BANDA-	9505	BANDA-COMPRESOR	PQ17530
BANDA-	9540	BANDA-ALT	K050340
BANDA-	9560	BANDA-ALT	K050350
MANGUERA DE AGUA-	30T 5/8"	BANDA-AA	8563 GS
MANGUERA DE CALEFACCIÓN-	CHARTER 1"	TERMOSTATO-175°	33960
1991		1994	
MANGUERA INFERIOR-TUBO A RAD.	24436	BANDA-VENT	K080465
MANGUERA SILICÓN-TUBO A RAD.	SIH250363C	BANDA-VENT	K080485
MANGUERA INFERIOR-MOTOR A TUBO	24436	BANDA-ALT	K050340
MANGUERA SILICÓN-MOTOR A TUBO	SIH200363C	BANDA-ALT	K050350
BANDA-ALT-VENT	K080675	BANDA-AA	8563 GS
BANDA-ALT-VENT	K080680	BANDA-AA	PQ17530
BANDA-ALT-VENT	K080700	TERMOSTATO-175°	33960
TERMOSTATO-190°	33579	1993	
TERMOSTATO-180°	33576	BANDA-VENT	K080465
TERMOSTATO-180°	33578	BANDA-VENT	K080485
TERMOSTATO-170°	33577	BANDA-ALT	K050340
BANDA-	9505	BANDA-ALT	K050350
BANDA-	9540	BANDA-AA	8563 GS
BANDA-	9560	BANDA-AA	PQ17530
		TERMOSTATO-175°	33960



1992		1997	
BANDA-VENT	K080465	BANDA-VENT	K080465
BANDA-ALT	K050340	BANDA-VENT	K080485
BANDA-ALT	K050350	BANDA-ALT	K050340
BANDA-AA	8563 GS	BANDA-ALT	K050350
TERMOSTATO-175°	33960	BANDA-AA	8563 GS
1991		BANDA-AA	PQ17530
BANDA-VENT	K080465	TERMOSTATO-190°	33579
BANDA-ALT	K050340	TERMOSTATO-180°	33576
BANDA-ALT	K050350	TERMOSTATO-180°	33578
BANDA-AA	8563 GS	TERMOSTATO-170°	33577
TERMOSTATO-175°	33960	1996	
1990		BANDA-VENT	K080465
BANDA-VENT	K080465	BANDA-VENT	K080485
BANDA-ALT	K050340	BANDA-ALT	K050340
BANDA-ALT	K050350	BANDA-ALT	K050350
BANDA-AA	8563 GS	BANDA-AA	8563 GS
TERMOSTATO-175°	33960	BANDA-AA	PQ17530
T450		TERMOSTATO-190°	33579
DETROIT DIESEL SERIES 50 DIESEL		TERMOSTATO-180°	33576
1996		TERMOSTATO-180°	33578
TERMOSTATO-190°	33599	TERMOSTATO-170°	33577
1995		1995	
TERMOSTATO-190°	33599	BANDA-VENT	K080465
CUMMINS M11 DIESEL		BANDA-VENT	K080485
1999		MANGUERA SILICÓN-TUBO A RAD.	SIH300363C
BANDA-VENT	K080465	MANGUERA SILICÓN-MOTOR A TUBO	SIH250363C
BANDA-VENT	K080485	BANDA-ALT	K050340
BANDA-ALT	K050340	BANDA-ALT	K050345
BANDA-ALT	K050350	BANDA-ALT	K050350
BANDA-AA	8563 GS	BANDA-AA	PQ17530
BANDA-AA	PQ17530	TERMOSTATO-190°	33579
1998		TERMOSTATO-180°	33576
BANDA-VENT	K080465	TERMOSTATO-180°	33578
BANDA-VENT	K080485	TERMOSTATO-170°	33577
BANDA-ALT	K050340	BANDA-	9530
BANDA-ALT	K050350	MANGUERA INFERIOR-	CHARTER 2 1/2"
BANDA-AA	8563 GS	MANGUERA INFERIOR-	CHARTER 3"
BANDA-AA	PQ17530	MANGUERA SILICÓN-	SIH250363C
TERMOSTATO-190°	33579	MANGUERA SUPERIOR-	CHARTER 2 1/2"
TERMOSTATO-180°	33576	1994	
TERMOSTATO-180°	33578	BANDA-VENT	K080465
TERMOSTATO-170°	33577	BANDA-VENT	K080485



MASTER SERVICIO PESADO 2014

KENWORTH

T450

BANDA-ALT	K050340	BANDA-AA	PQ17530
BANDA-ALT	K050350	TERMOSTATO-190°	33579
BANDA-AA	8563 GS	TERMOSTATO-180°	33576
BANDA-AA	PQ17530	TERMOSTATO-180°	33578
TERMOSTATO-190°	33579	TERMOSTATO-175°	33960
TERMOSTATO-180°	33576	TERMOSTATO-170°	33577
TERMOSTATO-180°	33578	BANDA-	9530
TERMOSTATO-170°	33577	BANDA-	9560
1993		1994	
BANDA-VENT	K080465	BANDA-VENT	K080465
BANDA-VENT	K080485	BANDA-VENT	K080485
BANDA-ALT	K050340	MANGUERA SILICÓN-TUBO A RAD.	SIH250363C
BANDA-ALT	K050350	MANGUERA SILICÓN-TUBO A RAD.	SIH300363C
BANDA-AA	8563 GS	MANGUERA SUPERIOR-TUBO A RAD.	CHARTER 2 1/2"
BANDA-AA	PQ17530	MANGUERA SILICÓN-MOTOR A TUBO	SIH250363C
1992		MANGUERA SUPERIOR-MOTOR A TUBO	24436
BANDA-VENT	K080465	MANGUERA SUPERIOR-MOTOR A TUBO	CHARTER 2 1/4"
BANDA-VENT	K080485	BANDA-ALT	K050340
BANDA-ALT	K050340	BANDA-ALT	K050350
BANDA-ALT	K050350	BANDA-AA	8563 GS
BANDA-AA	8563 GS	BANDA-AA	PQ17530
BANDA-AA	PQ17530	TERMOSTATO-190°	33579
1991		TERMOSTATO-180°	33576
BANDA-VENT	K080465	TERMOSTATO-180°	33578
BANDA-VENT	K080485	TERMOSTATO-175°	33960
BANDA-ALT	K050340	TERMOSTATO-170°	33577
BANDA-ALT	K050350	BANDA-	9530
BANDA-AA	8563 GS	BANDA-	9560
BANDA-AA	PQ17530	MANGUERA DE AGUA-	30T 5/8"
1990		MANGUERA DE CALEFACCIÓN-	35B 5/8"
BANDA-VENT	K080465	MANGUERA INFERIOR-	CHARTER 1 1/4"
BANDA-VENT	K080485	MANGUERA INFERIOR-	CHARTER 2 1/2"
BANDA-ALT	K050340	MANGUERA INFERIOR-	CHARTER 3"
BANDA-ALT	K050350	1993	
BANDA-AA	8563 GS	BANDA-VENT	K080465
BANDA-AA	PQ17530	BANDA-VENT	K080485
CUMMINS L10 DIESEL		MANGUERA SILICÓN-TUBO A RAD.	SIH250363C
1995		MANGUERA SILICÓN-TUBO A RAD.	SIH300363C
BANDA-VENT	K080465	MANGUERA SUPERIOR-TUBO A RAD.	CHARTER 2 1/2"
BANDA-VENT	K080485	MANGUERA SILICÓN-MOTOR A TUBO	SIH250363C
BANDA-ALT	K050340	MANGUERA SUPERIOR-MOTOR A TUBO	24436
BANDA-ALT	K050350	MANGUERA SUPERIOR-MOTOR A TUBO	CHARTER 2 1/4"
BANDA-AA	8563 GS		



MASTER SERVICIO PESADO 2014

KENWORTH

T450

BANDA-ALT	K050340	BANDA-VENT	K080465
BANDA-ALT	K050350	BANDA-VENT	K080485
BANDA-AA	8563 GS	MANGUERA SILICÓN-TUBO A RAD.	SIH250363C
BANDA-AA	PQ17530	MANGUERA SILICÓN-TUBO A RAD.	SIH300363C
TERMOSTATO-190°	33579	MANGUERA SUPERIOR-TUBO A RAD.	CHARTER 2 1/2"
TERMOSTATO-180°	33576	MANGUERA SILICÓN-MOTOR A TUBO	SIH250363C
TERMOSTATO-180°	33578	MANGUERA SUPERIOR-MOTOR A TUBO	24436
TERMOSTATO-175°	33960	MANGUERA SUPERIOR-MOTOR A TUBO	CHARTER 2 1/4"
TERMOSTATO-170°	33577	BANDA-ALT	K050340
BANDA-	9530	BANDA-ALT	K050350
BANDA-	9560	BANDA-AA	8563 GS
MANGUERA DE AGUA-	30T 5/8"	BANDA-AA	PQ17530
MANGUERA DE CALEFACCIÓN-	35B 5/8"	TERMOSTATO-190°	33579
MANGUERA INFERIOR-	CHARTER 1 1/4"	TERMOSTATO-180°	33576
MANGUERA INFERIOR-	CHARTER 2 1/2"	TERMOSTATO-180°	33578
MANGUERA INFERIOR-	CHARTER 3"	TERMOSTATO-175°	33960
		TERMOSTATO-170°	33577
1992		BANDA-	9530
BANDA-VENT	K080465	BANDA-	9560
BANDA-VENT	K080485	BANDA-	9560
MANGUERA SILICÓN-TUBO A RAD.	SIH250363C	MANGUERA DE AGUA-	30T 5/8"
MANGUERA SILICÓN-TUBO A RAD.	SIH300363C	MANGUERA DE CALEFACCIÓN-	35B 5/8"
MANGUERA SUPERIOR-TUBO A RAD.	CHARTER 2 1/2"	MANGUERA INFERIOR-	CHARTER 1 1/4"
MANGUERA SILICÓN-MOTOR A TUBO	SIH250363C	MANGUERA INFERIOR-	CHARTER 2 1/2"
MANGUERA SUPERIOR-MOTOR A TUBO	24436	MANGUERA INFERIOR-	CHARTER 3"
MANGUERA SUPERIOR-MOTOR A TUBO	CHARTER 2 1/4"		
		1990	
BANDA-ALT	K050340	BANDA-VENT	K080465
BANDA-ALT	K050350	BANDA-VENT	K080485
BANDA-AA	8563 GS	MANGUERA SUPERIOR-TUBO A RAD.	CHARTER 2 1/2"
BANDA-AA	PQ17530	MANGUERA SUPERIOR-MOTOR A TUBO	CHARTER 2 1/4"
TERMOSTATO-190°	33579	BANDA-ALT	K050340
TERMOSTATO-180°	33576	BANDA-ALT	K050350
TERMOSTATO-180°	33578	BANDA-AA	8563 GS
TERMOSTATO-175°	33960	BANDA-AA	PQ17530
TERMOSTATO-170°	33577	TERMOSTATO-175°	33960
BANDA-	9530	MANGUERA DE CALEFACCIÓN-	35B 5/8"
BANDA-	9560	MANGUERA INFERIOR-	CHARTER 1 1/4"
MANGUERA DE AGUA-	30T 5/8"	MANGUERA INFERIOR-	CHARTER 2 1/2"
MANGUERA DE CALEFACCIÓN-	35B 5/8"	MANGUERA INFERIOR-	CHARTER 3"
MANGUERA INFERIOR-	CHARTER 1 1/4"		
MANGUERA INFERIOR-	CHARTER 2 1/2"		
MANGUERA INFERIOR-	CHARTER 3"		
		CATERPILLAR 3306 DIESEL	
		1996	
		BANDA-VENT	9495
		BANDA-ALT-AA	2/9570PB
		BANDA-ALT-AA	9570



TERMOSTATO-175°	33549	MANGUERA DE CALEFACCIÓN-	35B 5/8"
MANGUERA DE AGUA-	30T 5/8"	MANGUERA INFERIOR-	CHARTER 2 1/2"
MANGUERA SILICÓN-	SIH250363C	MANGUERA SUPERIOR-	CHARTER 2 1/2"
1995		CATERPILLAR 3176 DIESEL	
BANDA-VENT	9495	1995	
BANDA-ALT-AA	2/9570PB	BANDA-ALT-VENT	K080675
BANDA-ALT-AA	9570	BANDA-ALT-VENT	K080680
TERMOSTATO-175°	33549	BANDA-ALT-VENT	K080700
MANGUERA DE AGUA-	30T 5/8"	TERMOSTATO-190°	33579
MANGUERA SILICÓN-	SIH250363C	TERMOSTATO-180°	33576
1994		TERMOSTATO-180°	33578
BANDA-VENT	9495	TERMOSTATO-170°	33577
BANDA-ALT-AA	2/9570PB	BANDA-	9505
BANDA-ALT-AA	9570	BANDA-	9540
TERMOSTATO-175°	33549	BANDA-	9560
MANGUERA DE AGUA-	30T 5/8"	1994	
MANGUERA SILICÓN-	SIH250363C	BANDA-ALT-VENT	K080675
1993		BANDA-ALT-VENT	K080680
BANDA-VENT	9495	BANDA-ALT-VENT	K080700
BANDA-ALT-AA	2/9570PB	TERMOSTATO-190°	33579
BANDA-ALT-AA	9570	TERMOSTATO-180°	33576
TERMOSTATO-175°	33549	TERMOSTATO-180°	33578
MANGUERA DE AGUA-	30T 5/8"	TERMOSTATO-170°	33577
MANGUERA SILICÓN-	SIH250363C	BANDA-	9505
1992		BANDA-	9540
BANDA-VENT	9495	BANDA-	9560
BANDA-ALT-AA	2/9570PB	1993	
BANDA-ALT-AA	9570	MANGUERA SILICÓN-TUBO A TUBO	SIH250363C
TERMOSTATO-175°	33549	MANGUERA SILICÓN-TUBO A RAD.	SIH300363C
MANGUERA DE AGUA-	30T 5/8"	MANGUERA INFERIOR-MOTOR A TUBO	24436
MANGUERA SILICÓN-	SIH250363C	MANGUERA SILICÓN-MOTOR A TUBO	SIH200363C
1991		BANDA-ALT-VENT	K080675
BANDA-VENT	9495	BANDA-ALT-VENT	K080680
BANDA-ALT-AA	2/9570PB	BANDA-ALT-VENT	K080700
BANDA-ALT-AA	9570	TERMOSTATO-190°	33579
TERMOSTATO-175°	33549	TERMOSTATO-180°	33576
MANGUERA DE AGUA-	30T 5/8"	TERMOSTATO-180°	33578
MANGUERA SILICÓN-	SIH250363C	TERMOSTATO-170°	33577
1990		BANDA-	9505
BANDA-VENT	PQ17500	BANDA-	9540
BANDA-ALT-AA	2/9570PB	BANDA-	9560
BANDA-ALT-AA	9570	MANGUERA DE AGUA-	30T 5/8"
TERMOSTATO-175°	33549	MANGUERA DE CALEFACCIÓN-	CHARTER 1"



MASTER SERVICIO PESADO 2014

KENWORTH

T450

1992		BANDA-ALT	K050340
MANGUERA INFERIOR-TUBO A RAD.	24436	BANDA-AA	PQ17540
MANGUERA SILICÓN-TUBO A RAD.	SIH250363C	TERMOSTATO-175°	33960
MANGUERA INFERIOR-MOTOR A TUBO	24436	1992	
MANGUERA SILICÓN-MOTOR A TUBO	SIH200363C	BANDA-VENT	K080485
BANDA-ALT-VENT	K080675	BANDA-ALT	K050340
BANDA-ALT-VENT	K080680	BANDA-AA	PQ17540
BANDA-ALT-VENT	K080700	TERMOSTATO-175°	33960
TERMOSTATO-190°	33579	1991	
TERMOSTATO-180°	33576	BANDA-VENT	K080465
TERMOSTATO-180°	33578	BANDA-ALT	K050350
TERMOSTATO-170°	33577	BANDA-AA	8563 GS
BANDA-	9505	TERMOSTATO-175°	33960
BANDA-	9540	1990	
BANDA-	9560	BANDA-VENT	K080465
MANGUERA DE AGUA-	30T 5/8"	BANDA-ALT	K050350
MANGUERA DE CALEFACCIÓN-	CHARTER 1"	BANDA-AA	8563 GS
		TERMOSTATO-175°	33960
1991		T600	
MANGUERA INFERIOR-TUBO A RAD.	24436	DETROIT DIESEL SERIE 60	
MANGUERA SILICÓN-TUBO A RAD.	SIH250363C	1999	
MANGUERA INFERIOR-MOTOR A TUBO	24436	BANDA-VENT	PQ17450
MANGUERA SILICÓN-MOTOR A TUBO	SIH200363C	BANDA-ALT-AA	2/9520PB
BANDA-ALT-VENT	K080675	BANDA-ALT-AA	PQ17520
BANDA-ALT-VENT	K080680	MANGUERA DE CALEFACCIÓN-	35B 5/8"
BANDA-ALT-VENT	K080700	MANGUERA DE CALEFACCIÓN-	CHARTER 3/4"
TERMOSTATO-190°	33579	MANGUERA INFERIOR-	CHARTER 2 1/2"
TERMOSTATO-180°	33576	MANGUERA INFERIOR-	CHARTER 3"
TERMOSTATO-180°	33578	MANGUERA SUPERIOR-	CHARTER 2 1/2"
TERMOSTATO-170°	33577	1998	
BANDA-	9505	BANDA-VENT	PQ17450
BANDA-	9540	BANDA-ALT-AA	2/9520PB
BANDA-	9560	BANDA-ALT-AA	PQ17520
MANGUERA DE AGUA-	30T 5/8"	MANGUERA DE CALEFACCIÓN-	35B 5/8"
MANGUERA DE CALEFACCIÓN-	CHARTER 1"	MANGUERA DE CALEFACCIÓN-	CHARTER 3/4"
		MANGUERA INFERIOR-	CHARTER 2 1/2"
		MANGUERA INFERIOR-	CHARTER 3"
		MANGUERA SUPERIOR-	CHARTER 2 1/2"
T450B			
CUMMINS L10 DIESEL			
1994		1997	
BANDA-VENT	K080485	BANDA-VENT	PQ17450
BANDA-ALT	K050340	BANDA-ALT-AA	2/9520PB
BANDA-AA	PQ17540	BANDA-ALT-AA	PQ17520
TERMOSTATO-175°	33960	MANGUERA DE CALEFACCIÓN-	35B 5/8"
1993			
BANDA-VENT	K080485		



MASTER SERVICIO PESADO 2014

KENWORTH

T600

MANGUERA DE CALEFACCIÓN-	CHARTER 3/4"	MANGUERA DE CALEFACCIÓN-	35B 5/8"
MANGUERA INFERIOR-	CHARTER 2 1/2"	MANGUERA DE CALEFACCIÓN-	CHARTER 3/4"
MANGUERA INFERIOR-	CHARTER 3"	MANGUERA INFERIOR-	CHARTER 2 1/2"
MANGUERA SUPERIOR-	CHARTER 2 1/2"	MANGUERA INFERIOR-	CHARTER 3"
1996		MANGUERA SUPERIOR-	CHARTER 2 1/2"
BANDA-VENT	8616 GS	1993	
BANDA-VENT	PQ17450	BANDA-VENT	2/9500PB
BANDA-ALT-AA	2/9520PB	BANDA-VENT	PQ17450
BANDA-ALT-AA	PQ17520	BANDA-VENT	PQ17470
BANDA-ALT 105A	PQ17540	BANDA-VENT	PQ17490
BANDA-ALT 100A	PQ17530	BANDA-VENT	PQ17500
MANGUERA DE CALEFACCIÓN-	35B 5/8"	BANDA-ALT-AA	2/9520PB
MANGUERA DE CALEFACCIÓN-	CHARTER 3/4"	BANDA-ALT-AA	PQ17530
MANGUERA INFERIOR-	CHARTER 2 1/2"	BANDA-ALT 105A	PQ17540
MANGUERA INFERIOR-	CHARTER 3"	BANDA-ALT 100A	PQ17530
MANGUERA SUPERIOR-	CHARTER 2 1/2"	BANDA-ALT	2/9500PB
1995		BANDA-ALT	2/9510PB
BANDA-VENT	8616 GS	BANDA-AA	8594 GS
BANDA-VENT	PQ17450	BANDA-AA	PQ17520
BANDA-ALT-AA	2/9520PB	BANDA-AA	PQ17550
BANDA-ALT-AA	PQ17520	MANGUERA DE CALEFACCIÓN-	35B 5/8"
BANDA-ALT 105A	PQ17540	MANGUERA DE PASO-	CHARTER 1 3/4"
BANDA-ALT 100A	PQ17530	MANGUERA INFERIOR-	CHARTER 2 1/2"
MANGUERA DE CALEFACCIÓN-	35B 5/8"	MANGUERA SUPERIOR-	CHARTER 2 1/2"
MANGUERA DE CALEFACCIÓN-	CHARTER 3/4"	1992	
MANGUERA INFERIOR-	CHARTER 2 1/2"	BANDA-VENT	2/9500PB
MANGUERA INFERIOR-	CHARTER 3"	BANDA-VENT	PQ17450
MANGUERA SUPERIOR-	CHARTER 2 1/2"	BANDA-VENT	PQ17470
1994		BANDA-VENT	PQ17490
BANDA-VENT	2/9500PB	BANDA-VENT	PQ17500
BANDA-VENT	PQ17450	BANDA-ALT-AA	2/9520PB
BANDA-VENT	PQ17470	BANDA-ALT-AA	PQ17530
BANDA-VENT	PQ17490	BANDA-ALT 105A	PQ17540
BANDA-VENT	PQ17500	BANDA-ALT 100A	PQ17530
BANDA-ALT-AA	2/9520PB	BANDA-ALT	2/9500PB
BANDA-ALT-AA	PQ17530	BANDA-ALT	2/9510PB
BANDA-ALT 105A	PQ17540	BANDA-AA	8594 GS
BANDA-ALT 100A	PQ17530	BANDA-AA	PQ17520
BANDA-ALT	2/9500PB	BANDA-AA	PQ17550
BANDA-ALT	2/9510PB	MANGUERA DE CALEFACCIÓN-	35B 5/8"
BANDA-AA	8594 GS	MANGUERA DE PASO-	CHARTER 1 3/4"
BANDA-AA	PQ17520	MANGUERA INFERIOR-	CHARTER 2 1/2"
BANDA-AA	PQ17550		



MANGUERA SUPERIOR-	CHARTER 2 1/2"	MANGUERA SILICÓN-MOTOR A TUBO	SIH250363C
1991			
BANDA-VENT	2/9500PB	BANDA-ALT-AA	2/9520PB
BANDA-VENT	PQ17450	BANDA-ALT-AA	9520
BANDA-VENT	PQ17470	TERMOSTATO-190°	33599
BANDA-VENT	PQ17490	MANGUERA DE AGUA-	30T 3/4"
BANDA-VENT	PQ17500	MANGUERA DE AGUA-	30T 5/8"
BANDA-ALT-AA	2/9520PB	MANGUERA SILICÓN-	SIH250363C
BANDA-ALT-AA	PQ17530	1998	
BANDA-ALT	2/9500PB	BANDA-VENT	9447
BANDA-ALT	2/9510PB	MANGUERA SILICÓN-TUBO A RAD.	SIH300363C
BANDA-ALT	PQ17500	MANGUERA SILICÓN-MOTOR A TUBO	SIH250363C
BANDA-ALT	PQ17540	BANDA-ALT-AA	2/9520PB
BANDA-AA	8594 GS	BANDA-ALT-AA	9520
BANDA-AA	PQ17520	TERMOSTATO-190°	33599
BANDA-AA	PQ17550	MANGUERA DE AGUA-	30T 3/4"
MANGUERA DE CALEFACCIÓN-	35B 5/8"	MANGUERA DE AGUA-	30T 5/8"
MANGUERA DE PASO-	CHARTER 1 3/4"	MANGUERA SILICÓN-	SIH250363C
MANGUERA INFERIOR-	CHARTER 2 1/2"	1997	
MANGUERA SUPERIOR-	CHARTER 2 1/2"	BANDA-VENT	9447
1990		MANGUERA SILICÓN-TUBO A RAD.	SIH300363C
BANDA-VENT	2/9500PB	MANGUERA SILICÓN-MOTOR A TUBO	SIH250363C
BANDA-VENT	PQ17450	BANDA-ALT-AA	2/9520PB
BANDA-VENT	PQ17470	BANDA-ALT-AA	9520
BANDA-VENT	PQ17490	TERMOSTATO-190°	33599
BANDA-VENT	PQ17500	MANGUERA DE AGUA-	30T 3/4"
BANDA-ALT-AA	2/9520PB	MANGUERA DE AGUA-	30T 5/8"
BANDA-ALT-AA	PQ17530	MANGUERA SILICÓN-	SIH250363C
BANDA-ALT	2/9500PB	1996	
BANDA-ALT	2/9510PB	BANDA-VENT	9610
BANDA-ALT	PQ17500	MANGUERA SILICÓN-TUBO A RAD.	SIH300363C
BANDA-ALT	PQ17540	MANGUERA SILICÓN-MOTOR A TUBO	SIH250363C
BANDA-AA	8594 GS	BANDA-ALT-AA	2/9520PB
BANDA-AA	PQ17520	BANDA-ALT-AA	9520
BANDA-AA	PQ17550	TERMOSTATO-190°	33599
MANGUERA DE CALEFACCIÓN-	35B 5/8"	MANGUERA DE AGUA-	30T 3/4"
MANGUERA DE PASO-	CHARTER 1 3/4"	MANGUERA DE AGUA-	30T 5/8"
MANGUERA INFERIOR-	CHARTER 2 1/2"	MANGUERA SILICÓN-	SIH250363C
MANGUERA SUPERIOR-	CHARTER 2 1/2"	1995	
DETROIT DIESEL 6 CIL, 12.7 L DIESEL		BANDA-VENT	9610
1999		MANGUERA SILICÓN-TUBO A RAD.	SIH300363C
BANDA-VENT	9447	MANGUERA SILICÓN-MOTOR A TUBO	SIH250363C
MANGUERA SILICÓN-TUBO A RAD.	SIH300363C	BANDA-ALT-AA	2/9520PB
		BANDA-ALT-AA	9520



MASTER SERVICIO PESADO 2014

KENWORTH

T600

TERMOSTATO-190°	33599	BANDA-VENT- OPCIONAL	9500
MANGUERA DE AGUA-	30T 3/4"	BANDA-VENT	3/9470PB
MANGUERA DE AGUA-	30T 5/8"	BANDA-VENT	3/9500PB
MANGUERA SILICÓN-	SIH250363C	BANDA-VENT	9447
1994		BANDA-VENT	9490
BANDA-VENT- OPCIONAL	9470	BANDA-ALT-AA	2/9520PB
BANDA-VENT- OPCIONAL	9500	BANDA-ALT-AA	9525
BANDA-VENT	3/9470PB	BANDA-ALT	2/9510PB
BANDA-VENT	3/9500PB	TERMOSTATO-190°	33599
BANDA-VENT	9447	BANDA-	9520
BANDA-VENT	9490	BANDA-	9545
MANGUERA SILICÓN-TUBO A RAD.	SIH300363C	BANDA-	9590
MANGUERA SILICÓN-MOTOR A TUBO	SIH250363C	MANGUERA DE AGUA-	30T 5/8"
BANDA-ALT-AA	2/9520PB	MANGUERA DE PASO-	CHARTER 1 3/4"
BANDA-ALT-AA	9525	MANGUERA SILICÓN-	SIH250363C
BANDA-ALT	2/9500PB	1991	
BANDA-ALT	2/9510PB	BANDA-VENT- OPCIONAL	9470
TERMOSTATO-190°	33599	BANDA-VENT- OPCIONAL	9500
BANDA-	9520	BANDA-VENT	3/9470PB
BANDA-	9545	BANDA-VENT	3/9500PB
BANDA-	9590	BANDA-VENT	9447
MANGUERA DE AGUA-	30T 3/4"	BANDA-VENT	9490
MANGUERA DE AGUA-	30T 5/8"	BANDA-ALT-AA	2/9520PB
MANGUERA SILICÓN-	SIH250363C	BANDA-ALT-AA	9525
1993		BANDA-ALT	2/9510PB
BANDA-VENT- OPCIONAL	9470	TERMOSTATO-190°	33599
BANDA-VENT- OPCIONAL	9500	BANDA-	9520
BANDA-VENT	3/9470PB	BANDA-	9545
BANDA-VENT	3/9500PB	BANDA-	9590
BANDA-VENT	9447	MANGUERA DE AGUA-	30T 5/8"
BANDA-VENT	9490	MANGUERA DE PASO-	CHARTER 1 3/4"
BANDA-ALT-AA	2/9520PB	MANGUERA SILICÓN-	SIH250363C
BANDA-ALT-AA	9525	DETROIT DIESEL 6 CIL, 11.1 L DIESEL	
BANDA-ALT	2/9510PB	1999	
TERMOSTATO-190°	33599	BANDA-VENT	9447
BANDA-	9520	MANGUERA SILICÓN-TUBO A RAD.	SIH300363C
BANDA-	9545	MANGUERA SILICÓN-MOTOR A TUBO	SIH250363C
BANDA-	9590	BANDA-ALT-AA	2/9520PB
MANGUERA DE AGUA-	30T 5/8"	BANDA-ALT-AA	9520
MANGUERA DE PASO-	CHARTER 1 3/4"	TERMOSTATO-190°	33599
MANGUERA SILICÓN-	SIH250363C	MANGUERA DE AGUA-	30T 3/4"
1992		MANGUERA DE AGUA-	30T 5/8"
BANDA-VENT- OPCIONAL	9470	MANGUERA SILICÓN-	SIH250363C



1998				
BANDA-VENT		9447	BANDA-VENT	3/9470PB
MANGUERA SILICÓN-TUBO A RAD.	SIH300363C		BANDA-VENT	3/9500PB
MANGUERA SILICÓN-MOTOR A TUBO	SIH250363C		BANDA-VENT	9447
BANDA-ALT-AA	2/9520PB		BANDA-VENT	9490
BANDA-ALT-AA	9520		MANGUERA SILICÓN-TUBO A RAD.	SIH300363C
TERMOSTATO-190°	33599		MANGUERA SILICÓN-MOTOR A TUBO	SIH250363C
MANGUERA DE AGUA-	30T 3/4"		BANDA-ALT-AA	2/9520PB
MANGUERA DE AGUA-	30T 5/8"		BANDA-ALT-AA	9525
MANGUERA SILICÓN-	SIH250363C		BANDA-ALT	2/9500PB
			BANDA-ALT	2/9510PB
1997			TERMOSTATO-190°	33599
BANDA-VENT	9447		BANDA-	9520
MANGUERA SILICÓN-TUBO A RAD.	SIH300363C		BANDA-	9545
MANGUERA SILICÓN-MOTOR A TUBO	SIH250363C		BANDA-	9590
BANDA-ALT-AA	2/9520PB		MANGUERA DE AGUA-	30T 3/4"
BANDA-ALT-AA	9520		MANGUERA DE AGUA-	30T 5/8"
TERMOSTATO-190°	33599		MANGUERA SILICÓN-	SIH250363C
MANGUERA DE AGUA-	30T 3/4"		1993	
MANGUERA DE AGUA-	30T 5/8"		BANDA-VENT- OPCIONAL	9470
MANGUERA SILICÓN-	SIH250363C		BANDA-VENT- OPCIONAL	9500
1996			BANDA-VENT	3/9470PB
BANDA-VENT	9610		BANDA-VENT	3/9500PB
MANGUERA SILICÓN-TUBO A RAD.	SIH300363C		BANDA-VENT	9447
MANGUERA SILICÓN-MOTOR A TUBO	SIH250363C		BANDA-VENT	9490
BANDA-ALT-AA	2/9520PB		BANDA-ALT-AA	2/9520PB
BANDA-ALT-AA	9520		BANDA-ALT-AA	9525
TERMOSTATO-190°	33599		BANDA-ALT	2/9510PB
MANGUERA DE AGUA-	30T 3/4"		TERMOSTATO-190°	33599
MANGUERA DE AGUA-	30T 5/8"		BANDA-	9520
MANGUERA SILICÓN-	SIH250363C		BANDA-	9545
1995			BANDA-	9590
BANDA-VENT	9610		MANGUERA DE AGUA-	30T 5/8"
MANGUERA SILICÓN-TUBO A RAD.	SIH300363C		MANGUERA DE PASO-	CHARTER 1 3/4"
MANGUERA SILICÓN-MOTOR A TUBO	SIH250363C		MANGUERA SILICÓN-	SIH250363C
BANDA-ALT-AA	2/9520PB		1992	
BANDA-ALT-AA	9520		BANDA-VENT- OPCIONAL	9470
TERMOSTATO-190°	33599		BANDA-VENT- OPCIONAL	9500
MANGUERA DE AGUA-	30T 3/4"		BANDA-VENT	3/9470PB
MANGUERA DE AGUA-	30T 5/8"		BANDA-VENT	3/9500PB
MANGUERA SILICÓN-	SIH250363C		BANDA-VENT	9447
1994			BANDA-VENT	9490
BANDA-VENT- OPCIONAL	9470		BANDA-ALT-AA	2/9520PB
BANDA-VENT- OPCIONAL	9500			



BANDA-ALT-AA	9525	1993	
BANDA-ALT	2/9510PB	BANDA-VENT	PQ28412
TERMOSTATO-190°	33599	BANDA-BA	K060434
BANDA-	9520	BANDA-ALT	PQ17500
BANDA-	9545	CUMMINS N14 DIESEL	
BANDA-	9590	2001	
MANGUERA DE AGUA-	30T 5/8"	MANGUERA SILICÓN-TUBO A RAD.	SIH250363C
MANGUERA DE PASO-	CHARTER 1 3/4"	MANGUERA SILICÓN-TUBO A RAD.	SIH300363C
MANGUERA SILICÓN-	SIH250363C	MANGUERA SUPERIOR-TUBO A RAD.	CHARTER 2 1/2"
1991		BANDA-TOMA DE FUERZA-VENT	PQ28437
BANDA-VENT- OPCIONAL	9470	BANDA-TOMA DE FUERZA-VENT	TR28437
BANDA-VENT- OPCIONAL	9500	BANDA-TOMA DE FUERZA-BA	K060425
BANDA-VENT	3/9470PB	BANDA-TOMA DE FUERZA-AA	9425
BANDA-VENT	3/9500PB	BANDA-TOMA DE FUERZA-AA	PQ17430
BANDA-VENT	9447	MANGUERA SILICÓN-MOTOR A TUBO	SIH250363C
BANDA-VENT	9490	MANGUERA SUPERIOR-MOTOR A TUBO	CHARTER 2 1/2"
BANDA-ALT-AA	2/9520PB	BANDA-ALT	9451
BANDA-ALT-AA	9525	BANDA-ALT	PQ17450
BANDA-ALT	2/9510PB	TERMOSTATO-190°	33579
TERMOSTATO-190°	33599	TERMOSTATO-180°	33576
BANDA-	9520	TERMOSTATO-180°	33578
BANDA-	9545	TERMOSTATO-170°	33577
BANDA-	9590	MANGUERA INFERIOR-	CHARTER 2 1/2"
MANGUERA DE AGUA-	30T 5/8"	MANGUERA INFERIOR-	CHARTER 3"
MANGUERA DE PASO-	CHARTER 1 3/4"	2000	
MANGUERA SILICÓN-	SIH250363C	MANGUERA SILICÓN-TUBO A RAD.	SIH250363C
CUMMINS SIGNATURE 600 DIESEL		MANGUERA SILICÓN-TUBO A RAD.	SIH300363C
2003		MANGUERA SUPERIOR-TUBO A RAD.	CHARTER 2 1/2"
BANDA-VENT	K100658	BANDA-TOMA DE FUERZA-VENT	PQ28437
POLEA DEL TENSOR-VENT	36092	BANDA-TOMA DE FUERZA-VENT	TR28437
TENSOR-VENT	38535	BANDA-TOMA DE FUERZA-BA	K060425
MANGUERA SILICÓN-TUBO A RAD.	SIH250363C	BANDA-TOMA DE FUERZA-AA	9425
MANGUERA SILICÓN-TUBO A RAD.	SIH300363C	BANDA-TOMA DE FUERZA-AA	PQ17430
MANGUERA SUPERIOR-TUBO A RAD.	CHARTER 2 1/2"	MANGUERA SILICÓN-MOTOR A TUBO	SIH250363C
BANDA-TOMA DE FUERZA-ALT-AA	K060685	MANGUERA SUPERIOR-MOTOR A TUBO	CHARTER 2 1/2"
POLEA DEL TENSOR-TOMA DE FUERZA-ALT-AA	36095	BANDA-ALT	9451
TENSOR-TOMA DE FUERZA-ALT-AA	38532	BANDA-ALT	PQ17450
MANGUERA SILICÓN-MOTOR A TUBO	SIH250363C	TERMOSTATO-190°	33579
MANGUERA SUPERIOR-MOTOR A TUBO	CHARTER 2 1/2"	TERMOSTATO-180°	33576
BANDA-BA-VENT	K100658	TERMOSTATO-180°	33578
MANGUERA INFERIOR-	CHARTER 2 1/2"	TERMOSTATO-170°	33577
MANGUERA INFERIOR-	CHARTER 3"	MANGUERA INFERIOR-	CHARTER 2 1/2"
CUMMINS NTC 400		MANGUERA INFERIOR-	CHARTER 3"



MASTER SERVICIO PESADO 2014

KENWORTH

T600

1999			
MANGUERA SILICÓN-TUBO A RAD.	SIH250363C	BANDA-ALT	9451
MANGUERA SILICÓN-TUBO A RAD.	SIH300363C	BANDA-ALT	PQ17450
MANGUERA SUPERIOR-TUBO A RAD.	CHARTER 2 1/2"	TERMOSTATO-190°	33579
BANDA-TOMA DE FUERZA-VENT	PQ28437	TERMOSTATO-180°	33576
BANDA-TOMA DE FUERZA-VENT	TR28437	TERMOSTATO-180°	33578
BANDA-TOMA DE FUERZA-BA	K060425	TERMOSTATO-170°	33577
MANGUERA SILICÓN-MOTOR A TUBO	SIH250363C	MANGUERA INFERIOR-	CHARTER 2 1/2"
MANGUERA SUPERIOR-MOTOR A TUBO	CHARTER 2 1/2"	MANGUERA INFERIOR-	CHARTER 3"
BANDA-ALT	9451	1996	
BANDA-ALT	PQ17450	BANDA-VENT- OPCIONAL	TR28412
TERMOSTATO-190°	33579	BANDA-VENT- OPCIONAL	TR28429
TERMOSTATO-180°	33576	BANDA-VENT- OPCIONAL	TR28437
TERMOSTATO-180°	33578	BANDA-VENT	2/TR28411PB
TERMOSTATO-170°	33577	BANDA-VENT	2/TR28429PB
MANGUERA INFERIOR-	CHARTER 2 1/2"	BANDA-VENT	2/TR28437PB
MANGUERA INFERIOR-	CHARTER 3"	BANDA-VENT	K080415
1998		BANDA-VENT	K080427
MANGUERA SILICÓN-TUBO A RAD.	SIH250363C	BANDA-VENT	K080465
MANGUERA SILICÓN-TUBO A RAD.	SIH300363C	BANDA-VENT	PQ28400
MANGUERA SUPERIOR-TUBO A RAD.	CHARTER 2 1/2"	BANDA-VENT	PQ28412
BANDA-TOMA DE FUERZA-VENT	PQ28437	BANDA-VENT	PQ28429
BANDA-TOMA DE FUERZA-VENT	TR28437	BANDA-VENT	PQ28437
BANDA-TOMA DE FUERZA-BA	K060425	BANDA-VENT	TR28400
MANGUERA SILICÓN-MOTOR A TUBO	SIH250363C	BANDA-VENT	TR28429
MANGUERA SUPERIOR-MOTOR A TUBO	CHARTER 2 1/2"	MANGUERA SILICÓN-TUBO A RAD.	SIH300363C
BANDA-ALT	9451	MANGUERA SILICÓN-MOTOR A TUBO	SIH250363C
BANDA-ALT	PQ17450	BANDA-BA	K040430
TERMOSTATO-190°	33579	BANDA-BA	K040445
TERMOSTATO-180°	33576	BANDA-BA	K060425
TERMOSTATO-180°	33578	BANDA-BA	K060435
TERMOSTATO-170°	33577	BANDA-ALT	2/9463PB
MANGUERA INFERIOR-	CHARTER 2 1/2"	BANDA-ALT	2/9470PB
MANGUERA INFERIOR-	CHARTER 3"	BANDA-ALT	9463
1997		BANDA-ALT	9470
MANGUERA SILICÓN-TUBO A RAD.	SIH250363C	BANDA-ALT	PQ17460
MANGUERA SILICÓN-TUBO A RAD.	SIH300363C	BANDA-ALT	PQ17470
MANGUERA SUPERIOR-TUBO A RAD.	CHARTER 2 1/2"	BANDA-AA	PQ17400
BANDA-TOMA DE FUERZA-VENT	PQ28437	BANDA-AA	PQ17420
BANDA-TOMA DE FUERZA-VENT	TR28437	TERMOSTATO-190°	33579
BANDA-TOMA DE FUERZA-BA	K060425	TERMOSTATO-180°	33576
MANGUERA SILICÓN-MOTOR A TUBO	SIH250363C	TERMOSTATO-180°	33578
MANGUERA SUPERIOR-MOTOR A TUBO	CHARTER 2 1/2"	TERMOSTATO-170°	33577



MASTER SERVICIO PESADO 2014

KENWORTH

T600

BANDA-	9400	MANGUERA INFERIOR-	CHARTER 3"
BANDA-	9420	MANGUERA SILICÓN-	SIH250363C
MANGUERA INFERIOR-	CHARTER 2 1/2"	MANGUERA SUPERIOR-	CHARTER 2 1/2"
MANGUERA INFERIOR-	CHARTER 3"	1994	
MANGUERA SILICÓN-	SIH250363C	BANDA-VENT- OPCIONAL	TR28412
MANGUERA SUPERIOR-	CHARTER 2 1/2"	BANDA-VENT- OPCIONAL	TR28429
1995		BANDA-VENT- OPCIONAL	TR28437
BANDA-VENT- OPCIONAL	TR28412	BANDA-VENT	2/TR28411PB
BANDA-VENT- OPCIONAL	TR28429	BANDA-VENT	2/TR28429PB
BANDA-VENT- OPCIONAL	TR28437	BANDA-VENT	2/TR28437PB
BANDA-VENT	2/TR28411PB	BANDA-VENT	K080415
BANDA-VENT	2/TR28429PB	BANDA-VENT	K080427
BANDA-VENT	2/TR28437PB	BANDA-VENT	K080465
BANDA-VENT	K080415	BANDA-VENT	PQ28400
BANDA-VENT	K080427	BANDA-VENT	PQ28412
BANDA-VENT	K080465	BANDA-VENT	PQ28429
BANDA-VENT	PQ28400	BANDA-VENT	PQ28437
BANDA-VENT	PQ28412	BANDA-VENT	TR28400
BANDA-VENT	PQ28429	MANGUERA SILICÓN-TUBO A RAD.	SIH300363C
BANDA-VENT	PQ28437	MANGUERA SILICÓN-MOTOR A TUBO	SIH250363C
BANDA-VENT	TR28400	BANDA-BA	K040430
MANGUERA SILICÓN-TUBO A RAD.	SIH300363C	BANDA-BA	K040445
MANGUERA SILICÓN-MOTOR A TUBO	SIH250363C	BANDA-BA	K060425
BANDA-BA	K040430	BANDA-BA	K060435
BANDA-BA	K040445	BANDA-ALT	2/9470PB
BANDA-BA	K060425	BANDA-ALT	9463
BANDA-BA	K060435	BANDA-ALT	9470
BANDA-ALT	2/9463PB	BANDA-ALT	PQ17460
BANDA-ALT	2/9470PB	BANDA-ALT	PQ17470
BANDA-ALT	9463	BANDA-AA	PQ17400
BANDA-ALT	9470	BANDA-AA	PQ17420
BANDA-ALT	PQ17460	TERMOSTATO-190°	33579
BANDA-ALT	PQ17470	TERMOSTATO-180°	33576
BANDA-AA	PQ17400	TERMOSTATO-180°	33578
BANDA-AA	PQ17420	TERMOSTATO-170°	33577
TERMOSTATO-190°	33579	BANDA-	9400
TERMOSTATO-180°	33576	BANDA-	9420
TERMOSTATO-180°	33578	MANGUERA INFERIOR-	CHARTER 2 1/2"
TERMOSTATO-170°	33577	MANGUERA INFERIOR-	CHARTER 3"
BANDA-	9400	MANGUERA SILICÓN-	SIH250363C
BANDA-	9420	MANGUERA SUPERIOR-	CHARTER 2 1/2"
MANGUERA INFERIOR-	CHARTER 2 1/2"	1993	



MASTER SERVICIO PESADO 2014

KENWORTH

T600

BANDA-VENT- OPCIONAL	TR28412	BANDA-VENT	2/TR28429PB
BANDA-VENT- OPCIONAL	TR28429	BANDA-VENT	2/TR28437PB
BANDA-VENT- OPCIONAL	TR28437	BANDA-VENT	K080415
BANDA-VENT	2/TR28411PB	BANDA-VENT	K080427
BANDA-VENT	2/TR28429PB	BANDA-VENT	K080465
BANDA-VENT	2/TR28437PB	BANDA-VENT	PQ28400
BANDA-VENT	K080415	BANDA-VENT	PQ28412
BANDA-VENT	K080427	BANDA-VENT	PQ28429
BANDA-VENT	K080465	BANDA-VENT	PQ28437
BANDA-VENT	PQ28400	BANDA-VENT	TR28400
BANDA-VENT	PQ28412	BANDA-BA	K040430
BANDA-VENT	PQ28429	BANDA-BA	K040445
BANDA-VENT	PQ28437	BANDA-BA	K060425
BANDA-VENT	TR28400	BANDA-BA	K060435
MANGUERA SILICÓN-TUBO A RAD.	SIH300363C	BANDA-ALT	2/9470PB
MANGUERA SILICÓN-MOTOR A TUBO	SIH250363C	BANDA-ALT	9463
BANDA-BA	K040430	BANDA-ALT	9470
BANDA-BA	K040445	BANDA-ALT	PQ17460
BANDA-BA	K060425	BANDA-ALT	PQ17470
BANDA-BA	K060435	BANDA-AA	PQ17400
BANDA-ALT	2/9470PB	BANDA-AA	PQ17420
BANDA-ALT	9463	TERMOSTATO-190°	33579
BANDA-ALT	9470	TERMOSTATO-180°	33576
BANDA-ALT	PQ17460	TERMOSTATO-180°	33578
BANDA-ALT	PQ17470	TERMOSTATO-170°	33577
BANDA-AA	PQ17400	BANDA-	9400
BANDA-AA	PQ17420	BANDA-	9420
TERMOSTATO-190°	33579	MANGUERA DE AGUA-	30T 5/8"
TERMOSTATO-180°	33576	MANGUERA DE CALEFACCIÓN-	35B 5/8"
TERMOSTATO-180°	33578	MANGUERA DE PASO-	CHARTER 1 1/2"
TERMOSTATO-170°	33577	MANGUERA INFERIOR-	CHARTER 1 1/4"
BANDA-	9400	MANGUERA INFERIOR-	CHARTER 2 1/2"
BANDA-	9420	MANGUERA SILICÓN-	SIH250363C
MANGUERA INFERIOR-	CHARTER 2 1/2"	MANGUERA SUPERIOR-	CHARTER 2 1/2"
MANGUERA INFERIOR-	CHARTER 3"	CUMMINS M11 DIESEL	
MANGUERA SILICÓN-	SIH250363C	1998	
MANGUERA SUPERIOR-	CHARTER 2 1/2"	BANDA-VENT	K080485
1992		BANDA-ALT	K050345
BANDA-VENT- OPCIONAL	TR28412	BANDA-AA	PQ17530
BANDA-VENT- OPCIONAL	TR28429	TERMOSTATO-190°	33579
BANDA-VENT- OPCIONAL	TR28437	TERMOSTATO-180°	33576
BANDA-VENT	2/TR28411PB	TERMOSTATO-180°	33578



MASTER SERVICIO PESADO 2014

KENWORTH

T600

TERMOSTATO-170°	33577	TERMOSTATO-180°	33576
BANDA-	9530	TERMOSTATO-180°	33578
1997		TERMOSTATO-170°	33577
BANDA-VENT	K080485	CUMMINS L10 DIESEL	
BANDA-ALT	K050345	1997	
BANDA-AA	PQ17530	BANDA-VENT	K080465
TERMOSTATO-190°	33579	BANDA-VENT	K080485
TERMOSTATO-180°	33576	BANDA-ALT	K050340
TERMOSTATO-180°	33578	BANDA-ALT	K050350
TERMOSTATO-170°	33577	BANDA-AA	8563 GS
BANDA-	9530	BANDA-AA	PQ17530
1996		TERMOSTATO-190°	33579
BANDA-VENT	K080485	TERMOSTATO-180°	33576
MANGUERA SILICÓN-TUBO A RAD.	SIH300363C	TERMOSTATO-180°	33578
MANGUERA SILICÓN-MOTOR A TUBO	SIH250363C	TERMOSTATO-175°	33960
BANDA-ALT	K050345	TERMOSTATO-170°	33577
BANDA-AA	PQ17530	BANDA-	9530
TERMOSTATO-190°	33579	BANDA-	9560
TERMOSTATO-180°	33576	1996	
TERMOSTATO-180°	33578	BANDA-VENT	K080465
TERMOSTATO-170°	33577	BANDA-VENT	K080485
BANDA-	9530	BANDA-ALT	K050340
MANGUERA INFERIOR-	CHARTER 2 1/2"	BANDA-ALT	K050350
MANGUERA INFERIOR-	CHARTER 3"	BANDA-AA	8563 GS
MANGUERA SILICÓN-	SIH250363C	BANDA-AA	PQ17530
MANGUERA SUPERIOR-	CHARTER 2 1/2"	TERMOSTATO-190°	33579
1995		TERMOSTATO-180°	33576
BANDA-VENT	K080485	TERMOSTATO-180°	33578
MANGUERA SILICÓN-TUBO A RAD.	SIH300363C	TERMOSTATO-175°	33960
MANGUERA SILICÓN-MOTOR A TUBO	SIH250363C	TERMOSTATO-170°	33577
BANDA-ALT	K050345	BANDA-	9530
BANDA-AA	PQ17530	BANDA-	9560
TERMOSTATO-190°	33579	1995	
TERMOSTATO-180°	33576	BANDA-VENT	K080465
TERMOSTATO-180°	33578	BANDA-VENT	K080485
TERMOSTATO-170°	33577	BANDA-ALT	K050340
BANDA-	9530	BANDA-ALT	K050350
MANGUERA INFERIOR-	CHARTER 2 1/2"	BANDA-AA	8563 GS
MANGUERA INFERIOR-	CHARTER 3"	BANDA-AA	PQ17530
MANGUERA SILICÓN-	SIH250363C	TERMOSTATO-190°	33579
MANGUERA SUPERIOR-	CHARTER 2 1/2"	TERMOSTATO-180°	33576
1994		TERMOSTATO-180°	33578
TERMOSTATO-190°	33579	TERMOSTATO-175°	33960



MASTER SERVICIO PESADO 2014

KENWORTH

T600

TERMOSTATO-170°	33577	TERMOSTATO-180°	33576
BANDA-	9530	TERMOSTATO-180°	33578
BANDA-	9560	TERMOSTATO-175°	33960
1994		TERMOSTATO-170°	33577
BANDA-VENT	K080465	BANDA-	9530
BANDA-VENT	K080485	BANDA-	9560
MANGUERA SILICÓN-TUBO A RAD.	SIH250363C	MANGUERA DE AGUA-	30T 5/8"
MANGUERA SILICÓN-TUBO A RAD.	SIH300363C	MANGUERA DE CALEFACCIÓN-	35B 5/8"
MANGUERA SUPERIOR-TUBO A RAD.	CHARTER 2 1/2"	MANGUERA INFERIOR-	CHARTER 1 1/4"
MANGUERA SILICÓN-MOTOR A TUBO	SIH250363C	MANGUERA INFERIOR-	CHARTER 2 1/2"
MANGUERA SUPERIOR-MOTOR A TUBO	24436	MANGUERA INFERIOR-	CHARTER 3"
MANGUERA SUPERIOR-MOTOR A TUBO	CHARTER 2 1/4"	1992	
BANDA-ALT	K050340	BANDA-VENT	K080465
BANDA-ALT	K050350	BANDA-VENT	K080485
BANDA-AA	8563 GS	MANGUERA SILICÓN-TUBO A RAD.	SIH250363C
BANDA-AA	PQ17530	MANGUERA SILICÓN-TUBO A RAD.	SIH300363C
TERMOSTATO-190°	33579	MANGUERA SUPERIOR-TUBO A RAD.	CHARTER 2 1/2"
TERMOSTATO-180°	33576	MANGUERA SILICÓN-MOTOR A TUBO	SIH250363C
TERMOSTATO-180°	33578	MANGUERA SUPERIOR-MOTOR A TUBO	24436
TERMOSTATO-175°	33960	MANGUERA SUPERIOR-MOTOR A TUBO	CHARTER 2 1/4"
TERMOSTATO-170°	33577	BANDA-ALT	K050340
BANDA-	9530	BANDA-ALT	K050350
BANDA-	9560	BANDA-AA	8563 GS
MANGUERA DE AGUA-	30T 5/8"	BANDA-AA	PQ17530
MANGUERA DE CALEFACCIÓN-	35B 5/8"	TERMOSTATO-190°	33579
MANGUERA INFERIOR-	CHARTER 1 1/4"	TERMOSTATO-180°	33576
MANGUERA INFERIOR-	CHARTER 2 1/2"	TERMOSTATO-180°	33578
MANGUERA INFERIOR-	CHARTER 3"	TERMOSTATO-175°	33960
1993		TERMOSTATO-170°	33577
BANDA-VENT	K080465	BANDA-	9530
BANDA-VENT	K080485	BANDA-	9560
MANGUERA SILICÓN-TUBO A RAD.	SIH250363C	MANGUERA DE AGUA-	30T 5/8"
MANGUERA SILICÓN-TUBO A RAD.	SIH300363C	MANGUERA DE CALEFACCIÓN-	35B 5/8"
MANGUERA SUPERIOR-TUBO A RAD.	CHARTER 2 1/2"	MANGUERA INFERIOR-	CHARTER 1 1/4"
MANGUERA SILICÓN-MOTOR A TUBO	SIH250363C	MANGUERA INFERIOR-	CHARTER 2 1/2"
MANGUERA SUPERIOR-MOTOR A TUBO	24436	MANGUERA INFERIOR-	CHARTER 3"
MANGUERA SUPERIOR-MOTOR A TUBO	CHARTER 2 1/4"	1991	
BANDA-ALT	K050340	BANDA-VENT	K080465
BANDA-ALT	K050350	BANDA-VENT	K080485
BANDA-AA	8563 GS	MANGUERA SILICÓN-TUBO A RAD.	SIH250363C
BANDA-AA	PQ17530	MANGUERA SILICÓN-TUBO A RAD.	SIH300363C
TERMOSTATO-190°	33579	MANGUERA SUPERIOR-TUBO A RAD.	CHARTER 2 1/2"



MASTER SERVICIO PESADO 2014

KENWORTH

T600

MANGUERA SILICÓN-MOTOR A TUBO	SIH250363C	TERMOSTATO-190°	34149
MANGUERA SUPERIOR-MOTOR A TUBO	24436	TERMOSTATO-180°	34146
MANGUERA SUPERIOR-MOTOR A TUBO	CHARTER 2 1/4"	TERMOSTATO-180°	34148
BANDA-ALT	K050340	BOMBA DE AGUA-	45051HD
BANDA-ALT	K050350	POLEA DEL TENSOR-	36165
BANDA-AA	8563 GS	2009	
BANDA-AA	PQ17530	MANGUERA SILICÓN-TUBO A RAD.	SIH250363C
TERMOSTATO-190°	33579	MANGUERA SILICÓN-TUBO A RAD.	SIH300363C
TERMOSTATO-180°	33576	BANDA-TOMA DE FUERZA-ALT-AA	K060637
TERMOSTATO-180°	33578	MANGUERA SILICÓN-MOTOR A TUBO	SIH250363C
TERMOSTATO-175°	33960	SENSOR-MOTOR	38610
TERMOSTATO-170°	33577	BANDA-ALT-VENT	K120864
BANDA-	9530	SENSOR-ALT-VENT	38587
BANDA-	9560	POLEA-AA	36223
MANGUERA DE AGUA-	30T 5/8"	TERMOSTATO-190°	34149
MANGUERA DE CALEFACCIÓN-	35B 5/8"	TERMOSTATO-180°	34146
MANGUERA INFERIOR-	CHARTER 1 1/4"	TERMOSTATO-180°	34148
MANGUERA INFERIOR-	CHARTER 2 1/2"	BOMBA DE AGUA-	45051HD
MANGUERA INFERIOR-	CHARTER 3"	BOMBA DE AGUA-	45054HD
1990		POLEA DEL TENSOR-	36165
BANDA-VENT	K080465	2008	
BANDA-VENT	K080485	MANGUERA SILICÓN-TUBO A RAD.	SIH250363C
MANGUERA SUPERIOR-TUBO A RAD.	CHARTER 2 1/2"	MANGUERA SILICÓN-TUBO A RAD.	SIH300363C
MANGUERA SUPERIOR-MOTOR A TUBO	CHARTER 2 1/4"	BANDA-TOMA DE FUERZA-ALT-AA	K060637
BANDA-ALT	K050340	MANGUERA SILICÓN-MOTOR A TUBO	SIH250363C
BANDA-ALT	K050350	SENSOR-MOTOR	38610
BANDA-AA	8563 GS	BANDA-ALT-VENT	K120864
BANDA-AA	PQ17530	SENSOR-ALT-VENT	38587
TERMOSTATO-175°	33960	POLEA-AA	36223
MANGUERA DE CALEFACCIÓN-	35B 5/8"	TERMOSTATO-190°	34149
MANGUERA INFERIOR-	CHARTER 1 1/4"	TERMOSTATO-180°	34146
MANGUERA INFERIOR-	CHARTER 2 1/2"	TERMOSTATO-180°	34148
MANGUERA INFERIOR-	CHARTER 3"	BOMBA DE AGUA-	45054HD
CUMMINS ISX DIESEL		POLEA DEL TENSOR-	36165
2010		2007	
MANGUERA SILICÓN-TUBO A RAD.	SIH250363C	MANGUERA SILICÓN-TUBO A RAD.	SIH250363C
MANGUERA SILICÓN-TUBO A RAD.	SIH300363C	MANGUERA SILICÓN-TUBO A RAD.	SIH300363C
BANDA-TOMA DE FUERZA-ALT-AA	K060637	BANDA-TOMA DE FUERZA-ALT-AA	K060637
MANGUERA SILICÓN-MOTOR A TUBO	SIH250363C	MANGUERA SILICÓN-MOTOR A TUBO	SIH250363C
SENSOR-MOTOR	38610	SENSOR-MOTOR	38610
BANDA-ALT-VENT	K120864	BANDA-ALT-VENT	K120864
SENSOR-ALT-VENT	38587	SENSOR-ALT-VENT	38587
POLEA-AA	36223	POLEA-AA	36223



MASTER SERVICIO PESADO 2014

KENWORTH

T600

TERMOSTATO-190°	34149	TERMOSTATO-180°	34146
TERMOSTATO-180°	34146	TERMOSTATO-180°	34148
TERMOSTATO-180°	34148	BOMBA DE AGUA-	45054HD
BOMBA DE AGUA-	45054HD	POLEA DEL TENSOR-	36165
POLEA DEL TENSOR-	36165	2003	
2006		MANGUERA SILICÓN-TUBO A RAD.	SIH250363C
MANGUERA SILICÓN-TUBO A RAD.	SIH250363C	MANGUERA SILICÓN-TUBO A RAD.	SIH300363C
MANGUERA SILICÓN-TUBO A RAD.	SIH300363C	BANDA-TOMA DE FUERZA-ALT-AA	K060637
BANDA-TOMA DE FUERZA-ALT-AA	K060637	MANGUERA SILICÓN-MOTOR A TUBO	SIH250363C
MANGUERA SILICÓN-MOTOR A TUBO	SIH250363C	TENSOR-MOTOR	38610
TENSOR-MOTOR	38610	BANDA-ALT-VENT	K120864
BANDA-ALT-VENT	K120864	TENSOR-ALT-VENT	38587
TENSOR-ALT-VENT	38587	POLEA-AA	36223
POLEA-AA	36223	TERMOSTATO-190°	34149
TERMOSTATO-190°	34149	TERMOSTATO-180°	34146
TERMOSTATO-180°	34146	TERMOSTATO-180°	34148
TERMOSTATO-180°	34148	BOMBA DE AGUA-	45054HD
BOMBA DE AGUA-	45054HD	POLEA DEL TENSOR-	36165
POLEA DEL TENSOR-	36165	2002	
2005		MANGUERA SILICÓN-TUBO A RAD.	SIH250363C
MANGUERA SILICÓN-TUBO A RAD.	SIH250363C	MANGUERA SILICÓN-TUBO A RAD.	SIH300363C
MANGUERA SILICÓN-TUBO A RAD.	SIH300363C	BANDA-TOMA DE FUERZA-ALT-AA	K060637
BANDA-TOMA DE FUERZA-ALT-AA	K060637	MANGUERA SILICÓN-MOTOR A TUBO	SIH250363C
MANGUERA SILICÓN-MOTOR A TUBO	SIH250363C	TENSOR-MOTOR	38610
TENSOR-MOTOR	38610	BANDA-ALT-VENT	K120864
BANDA-ALT-VENT	K120864	TENSOR-ALT-VENT	38587
TENSOR-ALT-VENT	38587	POLEA-AA	36223
POLEA-AA	36223	TERMOSTATO-190°	34149
TERMOSTATO-190°	34149	TERMOSTATO-180°	34146
TERMOSTATO-180°	34146	TERMOSTATO-180°	34148
TERMOSTATO-180°	34148	BOMBA DE AGUA-	45054HD
BOMBA DE AGUA-	45054HD	POLEA DEL TENSOR-	36165
POLEA DEL TENSOR-	36165	CUMMINS ISM DIESEL	
2004		2008	
MANGUERA SILICÓN-TUBO A RAD.	SIH250363C	POLEA-MOTOR	36308
MANGUERA SILICÓN-TUBO A RAD.	SIH300363C	POLEA DEL TENSOR-AA	36091
BANDA-TOMA DE FUERZA-ALT-AA	K060637	2007	
MANGUERA SILICÓN-MOTOR A TUBO	SIH250363C	POLEA-MOTOR	36308
TENSOR-MOTOR	38610	POLEA DEL TENSOR-AA	36091
BANDA-ALT-VENT	K120864	2006	
TENSOR-ALT-VENT	38587	POLEA-MOTOR	36308
POLEA-AA	36223	POLEA DEL TENSOR-AA	36091
TERMOSTATO-190°	34149	2005	



MASTER SERVICIO PESADO 2014

KENWORTH

T600

POLEA-MOTOR	36308	BANDA-ALT	2/9470PB
POLEA DEL TENSOR-AA	36091	BANDA-ALT	9463
2004		BANDA-ALT	9470
BANDA-ALT	K080702	TERMOSTATO-180°	33961
TENSOR-ALT	38521	TERMOSTATO-180°	33962
BANDA-AA	K060539	BANDA-	9400
TENSOR-AA	38505	BANDA-	9420
2002		MANGUERA DE AGUA-	30T 5/8"
MANGUERA INFERIOR-TUBO A RAD.	CHARTER 2 1/2"	MANGUERA DE PASO-	CHARTER 1 1/2"
MANGUERA SUPERIOR-TUBO A RAD.	CHARTER 2 1/2"	MANGUERA SILICÓN-	SIH250363C
BANDA-TOMA DE FUERZA-AA	9530	CATERPILLAR C15 DIESEL	
MANGUERA INFERIOR-MOTOR A TUBO	CHARTER 2 1/2"	2008	
MANGUERA SUPERIOR-MOTOR A TUBO	CHARTER 2 1/2"	BANDA-VENT-AA	K060575
BANDA-ALT-VENT	K080708	TENSOR-VENT-AA	38511
TENSOR-ALT-VENT	38521	MANGUERA INFERIOR-TUBO A RAD.	CHARTER 3"
2001		MANGUERA SUPERIOR-TUBO A RAD.	CHARTER 2 1/2"
MANGUERA INFERIOR-TUBO A RAD.	CHARTER 2 1/2"	MANGUERA INFERIOR-MOTOR A TUBO	CHARTER 3"
MANGUERA SUPERIOR-TUBO A RAD.	CHARTER 2 1/2"	MANGUERA SUPERIOR-MOTOR A TUBO	CHARTER 2 1/2"
BANDA-TOMA DE FUERZA-AA	9530	POLEA-MOTOR	36091
MANGUERA INFERIOR-MOTOR A TUBO	CHARTER 2 1/2"	POLEA-MOTOR	36341
MANGUERA SUPERIOR-MOTOR A TUBO	CHARTER 2 1/2"	BANDA-ALT-VENT	K080934
BANDA-ALT-VENT	K080708	TENSOR-ALT-VENT	38569
TENSOR-ALT-VENT	38521	TERMOSTATO-190°	33579
CUMMINS ISC 260		TERMOSTATO-180°	33576
2001		TERMOSTATO-180°	33578
BANDA-BA	K080797	TERMOSTATO-170°	33577
BANDA-ALT	PQ17450	BOMBA DE AGUA-	42062HD
CUMMINS 6 CIL, 14.0 L DIESEL		2007	
1991		BANDA-VENT-AA	K060575
BANDA-VENT- OPCIONAL	TR28412	TENSOR-VENT-AA	38511
BANDA-VENT- OPCIONAL	TR28429	MANGUERA INFERIOR-TUBO A RAD.	CHARTER 3"
BANDA-VENT- OPCIONAL	TR28437	MANGUERA SUPERIOR-TUBO A RAD.	CHARTER 2 1/2"
BANDA-VENT	2/TR28411PB	MANGUERA INFERIOR-MOTOR A TUBO	CHARTER 3"
BANDA-VENT	2/TR28429PB	MANGUERA SUPERIOR-MOTOR A TUBO	CHARTER 2 1/2"
BANDA-VENT	2/TR28437PB	POLEA-MOTOR	36091
BANDA-VENT	K080415	POLEA-MOTOR	36341
BANDA-VENT	K080427	BANDA-ALT-VENT	K080934
BANDA-VENT	K080465	TENSOR-ALT-VENT	38569
BANDA-VENT	TR28400	TERMOSTATO-190°	33579
BANDA-BA	K040430	TERMOSTATO-180°	33576
BANDA-BA	K040445	TERMOSTATO-180°	33578
BANDA-BA	K060425	TERMOSTATO-170°	33577
BANDA-BA	K060435	BOMBA DE AGUA-	42062HD



MASTER SERVICIO PESADO 2014

KENWORTH

T600

2006			BANDA-BA-VENT	2/TR22553PB
BANDA-VENT-AA	K060575		BANDA-BA-VENT	TR22553
TENSOR-VENT-AA	38508		BANDA-ALT-VENT-C/PURIF DE AIRE	K080842
MANGUERA INFERIOR-TUBO A RAD.	CHARTER 3"		BANDA-ALT-VENT-C/PURIF DE AIRE	K080893
MANGUERA SUPERIOR-TUBO A RAD.	CHARTER 2 1/2"		BANDA-ALT-VENT-AA	9620
MANGUERA INFERIOR-MOTOR A TUBO	CHARTER 3"		TENSOR-ALT-VENT	38506
MANGUERA SUPERIOR-MOTOR A TUBO	CHARTER 2 1/2"		TERMOSTATO-190°	33579
POLEA-MOTOR	36091		TERMOSTATO-180°	33576
POLEA-MOTOR	36093		TERMOSTATO-180°	33578
BANDA-ALT-VENT	K080934		TERMOSTATO-170°	33577
POLEA-ALT-VENT	36091	2003		
TENSOR-ALT-VENT	38506	BANDA-VENT-AA-C/PURIF DE AIRE		K060569
TERMOSTATO-190°	33579	POLEA DEL TENSOR-VENT-AA		36091
TERMOSTATO-180°	33576	TENSOR-VENT-AA		38508
TERMOSTATO-180°	33578	MANGUERA INFERIOR-TUBO A RAD.		CHARTER 3"
TERMOSTATO-170°	33577	MANGUERA SUPERIOR-TUBO A RAD.		CHARTER 2 1/2"
		MANGUERA INFERIOR-MOTOR A TUBO		CHARTER 3"
2005		MANGUERA SUPERIOR-MOTOR A TUBO		CHARTER 2 1/2"
BANDA-VENT-AA	K060569	POLEA-MOTOR		36091
POLEA DEL TENSOR-VENT-AA	36091	POLEA-MOTOR		36093
TENSOR-VENT-AA	38508	BANDA-BA-VENT		2/TR22553PB
MANGUERA INFERIOR-TUBO A RAD.	CHARTER 3"	BANDA-BA-VENT		TR22553
MANGUERA SUPERIOR-TUBO A RAD.	CHARTER 2 1/2"	BANDA-ALT-VENT-C/PURIF DE AIRE		K080842
MANGUERA INFERIOR-MOTOR A TUBO	CHARTER 3"	BANDA-ALT-VENT-C/PURIF DE AIRE		K080893
MANGUERA SUPERIOR-MOTOR A TUBO	CHARTER 2 1/2"	BANDA-ALT-VENT-AA		9620
POLEA-MOTOR	36091	TENSOR-ALT-VENT		38506
POLEA-MOTOR	36093	TERMOSTATO-190°		33579
BANDA-ALT-VENT-C/PURIF DE AIRE	K080842	TERMOSTATO-180°		33576
BANDA-ALT-VENT-C/PURIF DE AIRE	K080893	TERMOSTATO-180°		33578
TENSOR-ALT-VENT	38506	TERMOSTATO-170°		33577
TERMOSTATO-190°	33579		2002	
TERMOSTATO-180°	33576	BANDA-VENT-AA-C/PURIF DE AIRE		K060569
TERMOSTATO-180°	33578	POLEA DEL TENSOR-VENT-AA		36091
TERMOSTATO-170°	33577	TENSOR-VENT-AA		38508
		MANGUERA INFERIOR-TUBO A RAD.		CHARTER 3"
2004		MANGUERA SUPERIOR-TUBO A RAD.		CHARTER 2 1/2"
BANDA-VENT-AA-C/PURIF DE AIRE	K060569	MANGUERA INFERIOR-MOTOR A TUBO		CHARTER 3"
POLEA DEL TENSOR-VENT-AA	36091	MANGUERA SUPERIOR-MOTOR A TUBO		CHARTER 2 1/2"
TENSOR-VENT-AA	38508	POLEA-MOTOR		36091
MANGUERA INFERIOR-TUBO A RAD.	CHARTER 3"	POLEA-MOTOR		36093
MANGUERA SUPERIOR-TUBO A RAD.	CHARTER 2 1/2"	BANDA-BA-VENT		2/TR22553PB
MANGUERA INFERIOR-MOTOR A TUBO	CHARTER 3"	BANDA-BA-VENT		TR22553
MANGUERA SUPERIOR-MOTOR A TUBO	CHARTER 2 1/2"			
POLEA-MOTOR	36091			
POLEA-MOTOR	36093			



MASTER SERVICIO PESADO 2014

KENWORTH

T600

BANDA-ALT-VENT-C/PURIF DE AIRE	K080842	BANDA-ALT-VENT-AA	9620
BANDA-ALT-VENT-C/PURIF DE AIRE	K080893	TENSOR-ALT-VENT	38506
BANDA-ALT-VENT-AA	9620	TERMOSTATO-190°	33579
TENSOR-ALT-VENT	38506	TERMOSTATO-180°	33576
TERMOSTATO-190°	33579	TERMOSTATO-180°	33578
TERMOSTATO-180°	33576	TERMOSTATO-170°	33577
TERMOSTATO-180°	33578	CATERPILLAR C13 DIESEL	
TERMOSTATO-170°	33577	2008	
2001		TERMOSTATO-190°	33579
BANDA-VENT-AA-C/PURIF DE AIRE	K060569	TERMOSTATO-180°	33576
POLEA DEL TENSOR-VENT-AA	36091	TERMOSTATO-180°	33578
TENSOR-VENT-AA	38508	TERMOSTATO-170°	33577
MANGUERA INFERIOR-TUBO A RAD.	CHARTER 3"	2007	
MANGUERA SUPERIOR-TUBO A RAD.	CHARTER 2 1/2"	TERMOSTATO-190°	33579
MANGUERA INFERIOR-MOTOR A TUBO	CHARTER 3"	TERMOSTATO-180°	33576
MANGUERA SUPERIOR-MOTOR A TUBO	CHARTER 2 1/2"	TERMOSTATO-180°	33578
POLEA-MOTOR	36091	TERMOSTATO-170°	33577
POLEA-MOTOR	36093	2006	
BANDA-BA-VENT	2/TR22553PB	TERMOSTATO-190°	33579
BANDA-BA-VENT	TR22553	TERMOSTATO-180°	33576
BANDA-ALT-VENT-C/PURIF DE AIRE	K080842	TERMOSTATO-180°	33578
BANDA-ALT-VENT-C/PURIF DE AIRE	K080893	TERMOSTATO-170°	33577
BANDA-ALT-VENT-AA	9620	2005	
TENSOR-ALT-VENT	38506	TERMOSTATO-190°	33579
TERMOSTATO-190°	33579	TERMOSTATO-180°	33576
TERMOSTATO-180°	33576	TERMOSTATO-180°	33578
TERMOSTATO-180°	33578	TERMOSTATO-170°	33577
TERMOSTATO-170°	33577	2004	
2000		TERMOSTATO-190°	33579
BANDA-VENT-AA-C/PURIF DE AIRE	K060569	TERMOSTATO-180°	33576
POLEA DEL TENSOR-VENT-AA	36091	TERMOSTATO-180°	33578
TENSOR-VENT-AA	38508	TERMOSTATO-170°	33577
MANGUERA INFERIOR-TUBO A RAD.	CHARTER 3"	CATERPILLAR C12 DIESEL	
MANGUERA SUPERIOR-TUBO A RAD.	CHARTER 2 1/2"	2004	
MANGUERA INFERIOR-MOTOR A TUBO	CHARTER 3"	BANDA-VENT-AA	9510
MANGUERA SUPERIOR-MOTOR A TUBO	CHARTER 2 1/2"	BANDA-TOMA DE FUERZA-ALT-VENT	K080825
POLEA-MOTOR	36091	POLEA DEL TENSOR-TOMA DE FUERZA-ALT-VENT	36091
POLEA-MOTOR	36093	TENSOR-TOMA DE FUERZA-ALT-VENT	38506
BANDA-BA-VENT	2/TR22553PB	MANGUERA SILICÓN-RAD. A TUBO	SIH250363C
BANDA-BA-VENT	TR22553	MANGUERA SILICÓN-RAD. A TUBO	SIH300363C
BANDA-ALT-VENT-C/PURIF DE AIRE	K080842	MANGUERA SILICÓN-MOTOR A TUBO	SIH250363C
BANDA-ALT-VENT-C/PURIF DE AIRE	K080893	POLEA-ALT-VENT	36091
		TERMOSTATO-190°	33579



TERMOSTATO-180°	33576	2000	
TERMOSTATO-180°	33578	BANDA-VENT-AA	9555
TERMOSTATO-170°	33577	MANGUERA SILICÓN-TUBO A RAD.	SIH250363C
2003		MANGUERA SILICÓN-TUBO A RAD.	SIH300363C
BANDA-VENT-AA	9510	BANDA-TOMA DE FUERZA-ALT-VENT	K080825
BANDA-TOMA DE FUERZA-ALT-VENT	K080825	POLEA DEL TENSOR-TOMA DE FUERZA-ALT-VENT	36091
POLEA DEL TENSOR-TOMA DE FUERZA-ALT-VENT	36091	TENSOR-TOMA DE FUERZA-ALT-VENT	38506
TENSOR-TOMA DE FUERZA-ALT-VENT	38506	MANGUERA SILICÓN-MOTOR A TUBO	SIH300363C
MANGUERA SILICÓN-RAD. A TUBO	SIH250363C	MANGUERA SILICÓN-MOTOR A RAD.	SIH250363C
MANGUERA SILICÓN-RAD. A TUBO	SIH300363C	POLEA-ALT-VENT	36091
MANGUERA SILICÓN-MOTOR A TUBO	SIH250363C	TERMOSTATO-190°	33579
POLEA-ALT-VENT	36091	TERMOSTATO-180°	33576
TERMOSTATO-190°	33579	TERMOSTATO-180°	33578
TERMOSTATO-180°	33576	TERMOSTATO-170°	33577
TERMOSTATO-180°	33578	1999	
TERMOSTATO-170°	33577	BANDA-VENT-AA	9555
2002		MANGUERA SILICÓN-TUBO A RAD.	SIH250363C
BANDA-VENT-AA	9510	MANGUERA SILICÓN-TUBO A RAD.	SIH300363C
BANDA-TOMA DE FUERZA-ALT-VENT	K080825	BANDA-TOMA DE FUERZA-ALT-VENT	K080825
POLEA DEL TENSOR-TOMA DE FUERZA-ALT-VENT	36091	POLEA DEL TENSOR-TOMA DE FUERZA-ALT-VENT	36091
TENSOR-TOMA DE FUERZA-ALT-VENT	38506	TENSOR-TOMA DE FUERZA-ALT-VENT	38506
MANGUERA SILICÓN-RAD. A TUBO	SIH250363C	MANGUERA SILICÓN-MOTOR A TUBO	SIH300363C
MANGUERA SILICÓN-RAD. A TUBO	SIH300363C	MANGUERA SILICÓN-MOTOR A RAD.	SIH250363C
MANGUERA SILICÓN-MOTOR A TUBO	SIH250363C	POLEA-ALT-VENT	36091
POLEA-ALT-VENT	36091	TERMOSTATO-190°	33579
TERMOSTATO-190°	33579	TERMOSTATO-180°	33576
TERMOSTATO-180°	33576	TERMOSTATO-180°	33578
TERMOSTATO-180°	33578	TERMOSTATO-170°	33577
TERMOSTATO-170°	33577	1998	
2001		BANDA-VENT-AA	9555
BANDA-VENT-AA	9555	MANGUERA SILICÓN-TUBO A RAD.	SIH250363C
MANGUERA SILICÓN-TUBO A RAD.	SIH250363C	MANGUERA SILICÓN-TUBO A RAD.	SIH300363C
MANGUERA SILICÓN-TUBO A RAD.	SIH300363C	BANDA-TOMA DE FUERZA-ALT-VENT	K080825
BANDA-TOMA DE FUERZA-ALT-VENT	K080825	POLEA DEL TENSOR-TOMA DE FUERZA-ALT-VENT	36091
POLEA DEL TENSOR-TOMA DE FUERZA-ALT-VENT	36091	TENSOR-TOMA DE FUERZA-ALT-VENT	38506
TENSOR-TOMA DE FUERZA-ALT-VENT	38506	MANGUERA SILICÓN-MOTOR A TUBO	SIH300363C
MANGUERA SILICÓN-MOTOR A TUBO	SIH300363C	MANGUERA SILICÓN-MOTOR A RAD.	SIH250363C
MANGUERA SILICÓN-MOTOR A RAD.	SIH250363C	POLEA-ALT-VENT	36091
POLEA-ALT-VENT	36091	TERMOSTATO-190°	33579
TERMOSTATO-190°	33579	TERMOSTATO-180°	33576
TERMOSTATO-180°	33576	TERMOSTATO-180°	33578
TERMOSTATO-180°	33578	TERMOSTATO-170°	33577
TERMOSTATO-170°	33577	1997	



BANDA-VENT-AA	9555	BANDA-TOMA DE FUERZA-ALT-VENT	K080825
MANGUERA SILICÓN-TUBO A RAD.	SIH250363C	POLEA DEL TENSOR-TOMA DE FUERZA-ALT-VENT	36091
MANGUERA SILICÓN-TUBO A RAD.	SIH300363C	TENSOR-TOMA DE FUERZA-ALT-VENT	38506
BANDA-TOMA DE FUERZA-ALT-VENT	K080825	MANGUERA SILICÓN-RAD. A TUBO	SIH250363C
POLEA DEL TENSOR-TOMA DE FUERZA-ALT-VENT	36091	MANGUERA SILICÓN-RAD. A TUBO	SIH300363C
TENSOR-TOMA DE FUERZA-ALT-VENT	38506	MANGUERA SILICÓN-MOTOR A TUBO	SIH250363C
MANGUERA SILICÓN-MOTOR A TUBO	SIH300363C	POLEA-ALT-VENT	36091
MANGUERA SILICÓN-MOTOR A RAD.	SIH250363C	TERMOSTATO-190°	33579
POLEA-ALT-VENT	36091	TERMOSTATO-180°	33576
TERMOSTATO-190°	33579	TERMOSTATO-180°	33578
TERMOSTATO-180°	33576	TERMOSTATO-170°	33577
TERMOSTATO-180°	33578	2002	
TERMOSTATO-170°	33577	BANDA-VENT-AA	9510
1996		BANDA-TOMA DE FUERZA-ALT-VENT	K080825
BANDA-VENT-AA	9555	POLEA DEL TENSOR-TOMA DE FUERZA-ALT-VENT	36091
MANGUERA SILICÓN-TUBO A RAD.	SIH250363C	TENSOR-TOMA DE FUERZA-ALT-VENT	38506
MANGUERA SILICÓN-TUBO A RAD.	SIH300363C	MANGUERA SILICÓN-RAD. A TUBO	SIH250363C
BANDA-TOMA DE FUERZA-ALT-VENT	K080825	MANGUERA SILICÓN-RAD. A TUBO	SIH300363C
POLEA DEL TENSOR-TOMA DE FUERZA-ALT-VENT	36091	MANGUERA SILICÓN-MOTOR A TUBO	SIH250363C
TENSOR-TOMA DE FUERZA-ALT-VENT	38506	POLEA-ALT-VENT	36091
MANGUERA SILICÓN-MOTOR A TUBO	SIH300363C	TERMOSTATO-190°	33579
MANGUERA SILICÓN-MOTOR A RAD.	SIH250363C	TERMOSTATO-180°	33576
POLEA-ALT-VENT	36091	TERMOSTATO-180°	33578
TERMOSTATO-190°	33579	TERMOSTATO-170°	33577
TERMOSTATO-180°	33576	2001	
TERMOSTATO-180°	33578	BANDA-VENT-AA	9555
TERMOSTATO-170°	33577	MANGUERA SILICÓN-TUBO A RAD.	SIH250363C
CATERPILLAR C10 DIESEL		MANGUERA SILICÓN-TUBO A RAD.	SIH300363C
2004		BANDA-TOMA DE FUERZA-ALT-VENT	K080825
BANDA-VENT-AA	9510	POLEA DEL TENSOR-TOMA DE FUERZA-ALT-VENT	36091
BANDA-TOMA DE FUERZA-ALT-VENT	K080825	TENSOR-TOMA DE FUERZA-ALT-VENT	38506
POLEA DEL TENSOR-TOMA DE FUERZA-ALT-VENT	36091	MANGUERA SILICÓN-MOTOR A TUBO	SIH300363C
TENSOR-TOMA DE FUERZA-ALT-VENT	38506	MANGUERA SILICÓN-MOTOR A RAD.	SIH250363C
MANGUERA SILICÓN-RAD. A TUBO	SIH250363C	POLEA-ALT-VENT	36091
MANGUERA SILICÓN-RAD. A TUBO	SIH300363C	TERMOSTATO-190°	33579
MANGUERA SILICÓN-MOTOR A TUBO	SIH250363C	TERMOSTATO-180°	33576
POLEA-ALT-VENT	36091	TERMOSTATO-180°	33578
TERMOSTATO-190°	33579	TERMOSTATO-170°	33577
TERMOSTATO-180°	33576	2000	
TERMOSTATO-180°	33578	BANDA-VENT-AA	9555
TERMOSTATO-170°	33577	MANGUERA SILICÓN-TUBO A RAD.	SIH250363C
2003		MANGUERA SILICÓN-TUBO A RAD.	SIH300363C
BANDA-VENT-AA	9510	BANDA-TOMA DE FUERZA-ALT-VENT	K080825



POLEA DEL TENSOR-TOMA DE FUERZA-ALT-VENT	36091	TENSOR-TOMA DE FUERZA-ALT-VENT	38506
TENSOR-TOMA DE FUERZA-ALT-VENT	38506	MANGUERA SILICÓN-MOTOR A TUBO	SIH250363C
MANGUERA SILICÓN-MOTOR A TUBO	SIH300363C	MANGUERA SILICÓN-MOTOR A RAD.	SIH250363C
MANGUERA SILICÓN-MOTOR A RAD.	SIH250363C	POLEA-ALT-VENT	36091
POLEA-ALT-VENT	36091	TERMOSTATO-190°	33579
TERMOSTATO-190°	33579	TERMOSTATO-180°	33576
TERMOSTATO-180°	33576	TERMOSTATO-180°	33578
TERMOSTATO-180°	33578	TERMOSTATO-170°	33577
TERMOSTATO-170°	33577	1996	
1999		MANGUERA SILICÓN-TUBO A RAD.	SIH300363C
BANDA-VENT-AA	9555	MANGUERA SILICÓN-MOTOR A TUBO	SIH250363C
MANGUERA SILICÓN-TUBO A RAD.	SIH250363C	BANDA-MOTOR	K080690
MANGUERA SILICÓN-TUBO A RAD.	SIH300363C	TERMOSTATO-190°	33579
BANDA-TOMA DE FUERZA-ALT-VENT	K080825	TERMOSTATO-180°	33576
POLEA DEL TENSOR-TOMA DE FUERZA-ALT-VENT	36091	TERMOSTATO-180°	33578
TENSOR-TOMA DE FUERZA-ALT-VENT	38506	TERMOSTATO-170°	33577
MANGUERA SILICÓN-MOTOR A TUBO	SIH300363C	BANDA-	9555
MANGUERA SILICÓN-MOTOR A RAD.	SIH250363C	MANGUERA SILICÓN-	SIH250363C
POLEA-ALT-VENT	36091	CATERPILLAR 3406 DIESEL	
TERMOSTATO-190°	33579	1999	
TERMOSTATO-180°	33576	BANDA-VENT	TR22545
TERMOSTATO-180°	33578	MANGUERA SILICÓN-TUBO A TUBO	SIH250363C
TERMOSTATO-170°	33577	MANGUERA SILICÓN-TUBO A RAD.	SIH250363C
1998		MANGUERA SILICÓN-MOTOR A TUBO	SIH300363C
BANDA-VENT-AA	9555	BANDA-ALT-AA	2/9610PB
MANGUERA SILICÓN-TUBO A RAD.	SIH250363C	BANDA-ALT-AA	9610
MANGUERA SILICÓN-TUBO A RAD.	SIH300363C	TERMOSTATO-190°	33579
BANDA-TOMA DE FUERZA-ALT-VENT	K080825	TERMOSTATO-180°	33576
POLEA DEL TENSOR-TOMA DE FUERZA-ALT-VENT	36091	TERMOSTATO-180°	33578
TENSOR-TOMA DE FUERZA-ALT-VENT	38506	TERMOSTATO-170°	33577
MANGUERA SILICÓN-MOTOR A TUBO	SIH300363C	MANGUERA DE AGUA-	30T 3/4"
MANGUERA SILICÓN-MOTOR A RAD.	SIH250363C	MANGUERA SILICÓN-	SIH250363C
POLEA-ALT-VENT	36091	1998	
TERMOSTATO-190°	33579	BANDA-VENT	TR22545
TERMOSTATO-180°	33576	MANGUERA SILICÓN-TUBO A TUBO	SIH250363C
TERMOSTATO-180°	33578	MANGUERA SILICÓN-TUBO A RAD.	SIH250363C
TERMOSTATO-170°	33577	MANGUERA SILICÓN-MOTOR A TUBO	SIH300363C
1997		BANDA-ALT-AA	2/9610PB
BANDA-VENT-AA	9555	BANDA-ALT-AA	9610
MANGUERA SILICÓN-TUBO A RAD.	SIH250363C	TERMOSTATO-190°	33579
MANGUERA SILICÓN-TUBO A RAD.	SIH300363C	TERMOSTATO-180°	33576
BANDA-TOMA DE FUERZA-ALT-VENT	K080825	TERMOSTATO-180°	33578
POLEA DEL TENSOR-TOMA DE FUERZA-ALT-VENT	36091	TERMOSTATO-170°	33577



MASTER SERVICIO PESADO 2014

KENWORTH

T600

MANGUERA DE AGUA-	30T 3/4"	BANDA-VENT	2/TR22570PB
MANGUERA SILICÓN-	SIH250363C	BANDA-VENT	2/TR28437PB
1997		BANDA-VENT	TR22545
BANDA-VENT	TR22545	BANDA-VENT	TR22625
MANGUERA SILICÓN-TUBO A TUBO	SIH250363C	MANGUERA SILICÓN-TUBO A TUBO	SIH250363C
MANGUERA SILICÓN-TUBO A RAD.	SIH250363C	MANGUERA SILICÓN-TUBO A RAD.	SIH250363C
MANGUERA SILICÓN-MOTOR A TUBO	SIH300363C	MANGUERA SILICÓN-MOTOR A TUBO	SIH300363C
BANDA-ALT-AA	2/9610PB	BANDA-ALT-AA	2/9520PB
BANDA-ALT-AA	9610	BANDA-ALT-AA	2/9610PB
TERMOSTATO-190°	33579	BANDA-ALT-AA	9520
TERMOSTATO-180°	33576	BANDA-ALT-AA	9580
TERMOSTATO-180°	33578	BANDA-ALT-AA	9605
TERMOSTATO-170°	33577	BANDA-ALT-AA	9610
MANGUERA DE AGUA-	30T 3/4"	BANDA-ALT-AA	9620
MANGUERA SILICÓN-	SIH250363C	BANDA-ALT-AA	9650
1996		BANDA-ALT	2/9463PB
BANDA-VENT- OPCIONAL	TR22570	BANDA-ALT	9463
BANDA-VENT- OPCIONAL	TR28437	TERMOSTATO-190°	33579
BANDA-VENT	2/TR22570PB	TERMOSTATO-180°	33576
BANDA-VENT	2/TR28437PB	TERMOSTATO-180°	33578
BANDA-VENT	TR22545	TERMOSTATO-170°	33577
BANDA-VENT	TR22625	BANDA-	9425
MANGUERA SILICÓN-TUBO A TUBO	SIH250363C	MANGUERA DE AGUA-	30T 3/4"
MANGUERA SILICÓN-TUBO A RAD.	SIH250363C	MANGUERA SILICÓN-	SIH250363C
MANGUERA SILICÓN-MOTOR A TUBO	SIH300363C	1994	
BANDA-ALT-AA	2/9610PB	BANDA-VENT- OPCIONAL	TR22570
BANDA-ALT-AA	9580	BANDA-VENT- OPCIONAL	TR28437
BANDA-ALT-AA	9605	BANDA-VENT	2/TR22570PB
BANDA-ALT-AA	9610	BANDA-VENT	2/TR28437PB
BANDA-ALT-AA	9620	BANDA-VENT	TR22545
BANDA-ALT-AA	9650	BANDA-VENT	TR22625
BANDA-ALT	2/9463PB	MANGUERA SILICÓN-TUBO A TUBO	SIH250363C
BANDA-ALT	9463	MANGUERA SILICÓN-TUBO A RAD.	SIH250363C
TERMOSTATO-190°	33579	MANGUERA SILICÓN-MOTOR A TUBO	SIH300363C
TERMOSTATO-180°	33576	BANDA-ALT-AA	2/9520PB
TERMOSTATO-180°	33578	BANDA-ALT-AA	2/9610PB
TERMOSTATO-170°	33577	BANDA-ALT-AA	9520
BANDA-	9425	BANDA-ALT-AA	9580
MANGUERA DE AGUA-	30T 3/4"	BANDA-ALT-AA	9605
MANGUERA SILICÓN-	SIH250363C	BANDA-ALT-AA	9610
1995		BANDA-ALT-AA	9620
BANDA-VENT- OPCIONAL	TR22570	BANDA-ALT-AA	9650
BANDA-VENT- OPCIONAL	TR28437		



MASTER SERVICIO PESADO 2014

KENWORTH

T600

BANDA-ALT	2/9463PB	BANDA-VENT	TR22625
BANDA-ALT	9463	BANDA-ALT-AA	2/9520PB
TERMOSTATO-190°	33579	BANDA-ALT-AA	2/9610PB
TERMOSTATO-180°	33576	BANDA-ALT-AA	9520
TERMOSTATO-180°	33578	BANDA-ALT-AA	9580
TERMOSTATO-170°	33577	BANDA-ALT-AA	9605
BANDA-	9425	BANDA-ALT-AA	9610
MANGUERA DE AGUA-	30T 3/4"	BANDA-ALT-AA	9620
MANGUERA SILICÓN-	SIH250363C	BANDA-ALT-AA	9650
1993		BANDA-ALT	2/9463PB
BANDA-VENT- OPCIONAL	TR22570	BANDA-ALT	9463
BANDA-VENT- OPCIONAL	TR28437	TERMOSTATO-190°	33579
BANDA-VENT	2/TR22570PB	TERMOSTATO-180°	33576
BANDA-VENT	2/TR28437PB	TERMOSTATO-180°	33578
BANDA-VENT	TR22545	TERMOSTATO-170°	33577
BANDA-VENT	TR22625	BANDA-	9425
MANGUERA SILICÓN-TUBO A TUBO	SIH250363C	MANGUERA DE AGUA-	30T 5/8"
MANGUERA SILICÓN-TUBO A RAD.	SIH250363C	MANGUERA DE PASO-	CHARTER 1"
MANGUERA SILICÓN-MOTOR A TUBO	SIH300363C	MANGUERA SILICÓN-	SIH250363C
BANDA-ALT-AA	2/9520PB	MANGUERA SILICÓN-	SIH300363C
BANDA-ALT-AA	2/9610PB	1991	
BANDA-ALT-AA	9520	BANDA-VENT- OPCIONAL	TR22570
BANDA-ALT-AA	9580	BANDA-VENT- OPCIONAL	TR28437
BANDA-ALT-AA	9605	BANDA-VENT	2/TR22570PB
BANDA-ALT-AA	9610	BANDA-VENT	2/TR28437PB
BANDA-ALT-AA	9620	BANDA-VENT	TR22545
BANDA-ALT-AA	9650	BANDA-VENT	TR22625
BANDA-ALT	2/9463PB	BANDA-ALT-AA	2/9520PB
BANDA-ALT	9463	BANDA-ALT-AA	2/9610PB
TERMOSTATO-190°	33579	BANDA-ALT-AA	9520
TERMOSTATO-180°	33576	BANDA-ALT-AA	9580
TERMOSTATO-180°	33578	BANDA-ALT-AA	9605
TERMOSTATO-170°	33577	BANDA-ALT-AA	9610
BANDA-	9425	BANDA-ALT-AA	9620
MANGUERA DE AGUA-	30T 3/4"	BANDA-ALT-AA	9650
MANGUERA SILICÓN-	SIH250363C	BANDA-ALT	2/9463PB
1992		BANDA-ALT	9463
BANDA-VENT- OPCIONAL	TR22570	TERMOSTATO-190°	33579
BANDA-VENT- OPCIONAL	TR28437	TERMOSTATO-180°	33576
BANDA-VENT	2/TR22570PB	TERMOSTATO-180°	33578
BANDA-VENT	2/TR28437PB	TERMOSTATO-170°	33577
BANDA-VENT	TR22545	BANDA-	9425



MASTER SERVICIO PESADO 2014

KENWORTH

T600

MANGUERA DE AGUA-	30T 5/8"	BANDA-ALT-VENT	K080675
MANGUERA DE PASO-	CHARTER 1"	BANDA-ALT-VENT	K080680
MANGUERA SILICÓN-	SIH250363C	BANDA-ALT-VENT	K080700
MANGUERA SILICÓN-	SIH300363C	TERMOSTATO-190°	33579
1990		TERMOSTATO-180°	33576
BANDA-VENT (C/ALT 90A)	9670	TERMOSTATO-180°	33578
BANDA-VENT	2/TR28437PB	TERMOSTATO-170°	33577
BANDA-VENT	BX54	BANDA-	9505
BANDA-VENT	PQ24545	BANDA-	9540
BANDA-VENT	PQ24570	BANDA-	9560
BANDA-VENT	PQ28437	1994	
BANDA-VENT	TR22625	BANDA-ALT-VENT	K080675
BANDA-ALT-VENT	8643 GS	BANDA-ALT-VENT	K080680
BANDA-ALT-VENT	9650	BANDA-ALT-VENT	K080700
BANDA-ALT-AA	2/9520PB	TERMOSTATO-190°	33579
BANDA-ALT-AA	2/9610PB	TERMOSTATO-180°	33576
BANDA-ALT-AA	8580 GS	TERMOSTATO-180°	33578
BANDA-ALT-AA	8608 GS	TERMOSTATO-170°	33577
BANDA-ALT-AA	8650 GS	BANDA-	9505
BANDA-ALT-AA	9610	BANDA-	9540
BANDA-ALT-AA	9620	BANDA-	9560
BANDA-ALT-AA	PQ17520	1993	
BANDA-ALT	2/9463PB	MANGUERA SILICÓN-TUBO A TUBO	SIH250363C
BANDA-ALT	PQ17460	MANGUERA SILICÓN-TUBO A RAD.	SIH300363C
BANDA-AA	PQ17430	MANGUERA INFERIOR-MOTOR A TUBO	24436
TERMOSTATO-175°	33549	MANGUERA SILICÓN-MOTOR A TUBO	SIH200363C
MANGUERA DE CALEFACCIÓN-	35B 5/8"	BANDA-ALT-VENT	K080675
MANGUERA DE PASO-	CHARTER 1"	BANDA-ALT-VENT	K080680
MANGUERA INFERIOR-	CHARTER 3"	BANDA-ALT-VENT	K080700
MANGUERA SUPERIOR-	CHARTER 2 1/2"	TERMOSTATO-190°	33579
CATERPILLAR 3306 DIESEL		TERMOSTATO-180°	33576
1995		TERMOSTATO-180°	33578
TERMOSTATO-175°	33549	TERMOSTATO-170°	33577
1994		BANDA-	9505
TERMOSTATO-175°	33549	BANDA-	9540
1993		BANDA-	9560
TERMOSTATO-175°	33549	MANGUERA DE AGUA-	30T 5/8"
1992		MANGUERA DE CALEFACCIÓN-	CHARTER 1"
TERMOSTATO-175°	33549	1992	
1991		MANGUERA INFERIOR-TUBO A RAD.	24436
TERMOSTATO-175°	33549	MANGUERA SILICÓN-TUBO A RAD.	SIH250363C
CATERPILLAR 3176 DIESEL		MANGUERA INFERIOR-MOTOR A TUBO	24436
1995		MANGUERA SILICÓN-MOTOR A TUBO	SIH200363C



MASTER SERVICIO PESADO 2014

KENWORTH

T600

BANDA-ALT-VENT	K080675	BANDA-ALT	K050350
BANDA-ALT-VENT	K080680	BANDA-AA	8563 GS
BANDA-ALT-VENT	K080700	BANDA-AA	PQ17530
TERMOSTATO-190°	33579	1993	
TERMOSTATO-180°	33576	BANDA-VENT	K080465
TERMOSTATO-180°	33578	BANDA-VENT	K080485
TERMOSTATO-170°	33577	BANDA-ALT	K050340
BANDA-	9505	BANDA-ALT	K050350
BANDA-	9540	BANDA-AA	8563 GS
BANDA-	9560	BANDA-AA	PQ17530
MANGUERA DE AGUA-	30T 5/8"	1992	
MANGUERA DE CALEFACCIÓN-	CHARTER 1"	BANDA-VENT	K080465
1991		BANDA-ALT	K050340
MANGUERA INFERIOR-TUBO A RAD.	24436	BANDA-ALT	K050350
MANGUERA SILICÓN-TUBO A RAD.	SIH250363C	BANDA-AA	8563 GS
MANGUERA INFERIOR-MOTOR A TUBO	24436	T660	
MANGUERA SILICÓN-MOTOR A TUBO	SIH200363C	CUMMINS ISX DIESEL	
BANDA-ALT-VENT	K080675	2014	
BANDA-ALT-VENT	K080680	BANDA-TOMA DE FUERZA-AA	K060637
BANDA-ALT-VENT	K080700	MANGUERA SILICÓN-RAD. A TUBO	SIH250363C
TERMOSTATO-190°	33579	MANGUERA SILICÓN-MOTOR A TUBO	SIH250363C
TERMOSTATO-180°	33576	MANGUERA SUPERIOR-MOTOR A TUBO	21891
TERMOSTATO-180°	33578	BANDA-ALT-VENT	K120872
TERMOSTATO-170°	33577	POLEA-ALT-VENT	36165
BANDA-	9505	TENSOR-ALT-VENT	38587
BANDA-	9540	TENSOR-ALT-VENT	38610
BANDA-	9560	POLEA-AA	36223
MANGUERA DE AGUA-	30T 5/8"	BOMBA DE AGUA-	45051HD
MANGUERA DE CALEFACCIÓN-	CHARTER 1"	2013	
T600A		BANDA-TOMA DE FUERZA-AA	K060637
CUMMINS L10 DIESEL		MANGUERA SILICÓN-RAD. A TUBO	SIH250363C
1995		MANGUERA SILICÓN-MOTOR A TUBO	SIH250363C
BANDA-VENT	K080465	MANGUERA SUPERIOR-MOTOR A TUBO	21891
BANDA-VENT	K080485	BANDA-ALT-VENT	K120872
BANDA-ALT	K050340	POLEA-ALT-VENT	36165
BANDA-ALT	K050350	TENSOR-ALT-VENT	38587
BANDA-AA	8563 GS	TENSOR-ALT-VENT	38610
BANDA-AA	PQ17530	POLEA-AA	36223
1994		BOMBA DE AGUA-	45051HD
BANDA-VENT	K080465	2012	
BANDA-VENT	K080485	BANDA-TOMA DE FUERZA-AA	K060637
BANDA-ALT	K050340	MANGUERA SILICÓN-RAD. A TUBO	SIH250363C
		MANGUERA SILICÓN-MOTOR A TUBO	SIH250363C



MASTER SERVICIO PESADO 2014

KENWORTH

T660

MANGUERA SUPERIOR-MOTOR A TUBO	21891	MANGUERA SUPERIOR-MOTOR A TUBO	21891
BANDA-ALT-VENT	K120872	BANDA-ALT-VENT	K120872
POLEA-ALT-VENT	36165	POLEA-ALT-VENT	36165
TENSOR-ALT-VENT	38587	TENSOR-ALT-VENT	38587
TENSOR-ALT-VENT	38610	TENSOR-ALT-VENT	38610
POLEA-AA	36223	POLEA-AA	36223
BOMBA DE AGUA-	45051HD	2007	
2011		BANDA-TOMA DE FUERZA-AA	K060637
BANDA-TOMA DE FUERZA-AA	K060637	MANGUERA SILICÓN-RAD. A TUBO	SIH250363C
MANGUERA SILICÓN-RAD. A TUBO	SIH250363C	MANGUERA SILICÓN-MOTOR A TUBO	SIH250363C
MANGUERA SILICÓN-MOTOR A TUBO	SIH250363C	MANGUERA SUPERIOR-MOTOR A TUBO	21891
MANGUERA SUPERIOR-MOTOR A TUBO	21891	BANDA-ALT-VENT	K120872
BANDA-ALT-VENT	K120872	POLEA-ALT-VENT	36165
POLEA-ALT-VENT	36165	TENSOR-ALT-VENT	38587
TENSOR-ALT-VENT	38587	TENSOR-ALT-VENT	38610
TENSOR-ALT-VENT	38610	POLEA-AA	36223
POLEA-AA	36223	CATERPILLAR C15 DIESEL	
BOMBA DE AGUA-	45051HD	2013	
2010		BANDA-VENT-AA	K120980
BANDA-TOMA DE FUERZA-AA	K060637	POLEA-VENT-AA	36165
MANGUERA SILICÓN-RAD. A TUBO	SIH250363C	TENSOR-VENT-AA	38587
MANGUERA SILICÓN-MOTOR A TUBO	SIH250363C	MANGUERA INFERIOR-RAD. A TUBO	21135
MANGUERA SUPERIOR-MOTOR A TUBO	21891	MANGUERA SILICÓN-RAD. A TUBO	SIH250363C
BANDA-ALT-VENT	K120872	MANGUERA SILICÓN-MOTOR A TUBO	SIH250363C
POLEA-ALT-VENT	36165	MANGUERA SUPERIOR-MOTOR A TUBO	21891
TENSOR-ALT-VENT	38587	BANDA-ALT-VENT	K060736
TENSOR-ALT-VENT	38610	TENSOR-ALT-VENT	38609
POLEA-AA	36223	TERMOSTATO-190°	33579
BOMBA DE AGUA-	45051HD	TERMOSTATO-180°	33576
2009		TERMOSTATO-180°	33578
BANDA-TOMA DE FUERZA-AA	K060637	TERMOSTATO-170°	33577
MANGUERA SILICÓN-RAD. A TUBO	SIH250363C	BOMBA DE AGUA-	44062HD
MANGUERA SILICÓN-MOTOR A TUBO	SIH250363C	2012	
MANGUERA SUPERIOR-MOTOR A TUBO	21891	BANDA-VENT-AA	K120980
BANDA-ALT-VENT	K120872	POLEA-VENT-AA	36165
POLEA-ALT-VENT	36165	TENSOR-VENT-AA	38587
TENSOR-ALT-VENT	38587	MANGUERA INFERIOR-RAD. A TUBO	21135
TENSOR-ALT-VENT	38610	MANGUERA SILICÓN-RAD. A TUBO	SIH250363C
POLEA-AA	36223	MANGUERA SILICÓN-MOTOR A TUBO	SIH250363C
2008		MANGUERA SUPERIOR-MOTOR A TUBO	21891
BANDA-TOMA DE FUERZA-AA	K060637	BANDA-ALT-VENT	K060736
MANGUERA SILICÓN-RAD. A TUBO	SIH250363C	TENSOR-ALT-VENT	38609
MANGUERA SILICÓN-MOTOR A TUBO	SIH250363C	TERMOSTATO-190°	33579



TERMOSTATO-180°	33576	TENSOR-ALT-VENT	38609
TERMOSTATO-180°	33578	TERMOSTATO-190°	33579
TERMOSTATO-170°	33577	TERMOSTATO-180°	33576
BOMBA DE AGUA-	44062HD	TERMOSTATO-180°	33578
2011		TERMOSTATO-170°	33577
BANDA-VENT-AA	K120980	BOMBA DE AGUA-	44062HD
POLEA-VENT-AA	36165	2008	
TENSOR-VENT-AA	38587	BANDA-VENT-AA	K120980
MANGUERA INFERIOR-RAD. A TUBO	21135	POLEA-VENT-AA	36165
MANGUERA SILICÓN-RAD. A TUBO	SIH250363C	TENSOR-VENT-AA	38587
MANGUERA SILICÓN-MOTOR A TUBO	SIH250363C	MANGUERA INFERIOR-RAD. A TUBO	21135
MANGUERA SUPERIOR-MOTOR A TUBO	21891	MANGUERA SILICÓN-RAD. A TUBO	SIH250363C
BANDA-ALT-VENT	K060736	MANGUERA SILICÓN-MOTOR A TUBO	SIH250363C
TENSOR-ALT-VENT	38609	MANGUERA SUPERIOR-MOTOR A TUBO	21891
TERMOSTATO-190°	33579	BANDA-ALT-VENT	K060736
TERMOSTATO-180°	33576	TENSOR-ALT-VENT	38609
TERMOSTATO-180°	33578	TERMOSTATO-190°	33579
TERMOSTATO-170°	33577	TERMOSTATO-180°	33576
BOMBA DE AGUA-	44062HD	TERMOSTATO-180°	33578
2010		TERMOSTATO-170°	33577
BANDA-VENT-AA	K120980	BOMBA DE AGUA-	44062HD
POLEA-VENT-AA	36165	2007	
TENSOR-VENT-AA	38587	BANDA-VENT-AA	K120980
MANGUERA INFERIOR-RAD. A TUBO	21135	POLEA-VENT-AA	36165
MANGUERA SILICÓN-RAD. A TUBO	SIH250363C	TENSOR-VENT-AA	38587
MANGUERA SILICÓN-MOTOR A TUBO	SIH250363C	MANGUERA INFERIOR-RAD. A TUBO	21135
MANGUERA SUPERIOR-MOTOR A TUBO	21891	MANGUERA SILICÓN-RAD. A TUBO	SIH250363C
BANDA-ALT-VENT	K060736	MANGUERA SILICÓN-MOTOR A TUBO	SIH250363C
TENSOR-ALT-VENT	38609	MANGUERA SUPERIOR-MOTOR A TUBO	21891
TERMOSTATO-190°	33579	BANDA-ALT-VENT	K060736
TERMOSTATO-180°	33576	TENSOR-ALT-VENT	38609
TERMOSTATO-180°	33578	TERMOSTATO-190°	33579
TERMOSTATO-170°	33577	TERMOSTATO-180°	33576
BOMBA DE AGUA-	44062HD	TERMOSTATO-180°	33578
2009		TERMOSTATO-170°	33577
BANDA-VENT-AA	K120980	BOMBA DE AGUA-	44062HD
POLEA-VENT-AA	36165	CATERPILLAR C13 DIESEL	
TENSOR-VENT-AA	38587	2013	
MANGUERA INFERIOR-RAD. A TUBO	21135	BANDA-VENT-AA	K100946
MANGUERA SILICÓN-RAD. A TUBO	SIH250363C	TENSOR-VENT-AA	38646
MANGUERA SILICÓN-MOTOR A TUBO	SIH250363C	BANDA-ALT	K060858
MANGUERA SUPERIOR-MOTOR A TUBO	21891	POLEA-ALT	36227
BANDA-ALT-VENT	K060736	TENSOR-ALT	38635



MASTER SERVICIO PESADO 2014

KENWORTH

T660

TERMOSTATO-190°	33579	TENSOR-ALT	38635
TERMOSTATO-180°	33576	TERMOSTATO-190°	33579
TERMOSTATO-180°	33578	TERMOSTATO-180°	33576
TERMOSTATO-170°	33577	TERMOSTATO-180°	33578
MANGUERA SUPERIOR-	28212	TERMOSTATO-170°	33577
2012		MANGUERA SUPERIOR-	28212
BANDA-VENT-AA	K100946	T800	
TENSOR-VENT-AA	38646	DETROIT DIESEL SERIE 60, 12.7 L	
BANDA-ALT	K060858	1995	
POLEA-ALT	36227	BANDA-VENT	PQ17450
TENSOR-ALT	38635	BANDA-VENT	PQ17470
TERMOSTATO-190°	33579	BANDA-ALT	PQ17520
TERMOSTATO-180°	33576	1994	
TERMOSTATO-180°	33578	BANDA-VENT	PQ17450
TERMOSTATO-170°	33577	BANDA-VENT	PQ17470
MANGUERA SUPERIOR-	28212	BANDA-ALT-BA-AA	PQ17520
2011		BANDA-ALT	PQ17520
BANDA-VENT-AA	K100946	1993	
TENSOR-VENT-AA	38646	BANDA-VENT	PQ17450
BANDA-ALT	K060858	BANDA-VENT	PQ17470
POLEA-ALT	36227	BANDA-ALT-BA-AA	PQ17520
TENSOR-ALT	38635	BANDA-ALT	PQ17520
TERMOSTATO-190°	33579	1992	
TERMOSTATO-180°	33576	BANDA-VENT	PQ17450
TERMOSTATO-180°	33578	BANDA-VENT	PQ17470
TERMOSTATO-170°	33577	BANDA-ALT-BA-AA	PQ17520
MANGUERA SUPERIOR-	28212	BANDA-ALT	PQ17530
2010		1991	
BANDA-VENT-AA	K100946	BANDA-ALT-AA	PQ17530
TENSOR-VENT-AA	38646	BANDA-ALT	PQ17510
BANDA-ALT	K060858	BANDA-ALT	PQ17530
POLEA-ALT	36227	BANDA-AA	8543 GS
TENSOR-ALT	38635	BANDA-AA	8594 GS
TERMOSTATO-190°	33579	BANDA-AA	PQ17540
TERMOSTATO-180°	33576	1990	
TERMOSTATO-180°	33578	BANDA-VENT	8543 GS
TERMOSTATO-170°	33577	BANDA-VENT	PQ17470
MANGUERA SUPERIOR-	28212	BANDA-VENT	PQ17480
2009		BANDA-ALT	PQ17510
BANDA-VENT-AA	K100946	BANDA-AA	PQ17540
TENSOR-VENT-AA	38646	DETROIT DIESEL SERIE 60, 11.1 L	
BANDA-ALT	K060858	1995	
POLEA-ALT	36227	BANDA-VENT	PQ17450



BANDA-VENT	PQ17470	1998	
BANDA-ALT	PQ17520	BANDA-VENT	PQ17450
1994		BANDA-ALT-AA	2/9520PB
BANDA-VENT	PQ17450	BANDA-ALT-AA	PQ17520
BANDA-VENT	PQ17470	MANGUERA DE CALEFACCIÓN-	35B 5/8"
BANDA-ALT-BA-AA	PQ17520	MANGUERA DE CALEFACCIÓN-	CHARTER 3/4"
BANDA-ALT	PQ17520	MANGUERA INFERIOR-	CHARTER 2 1/2"
1993		MANGUERA INFERIOR-	CHARTER 3"
BANDA-VENT	PQ17450	MANGUERA SUPERIOR-	CHARTER 2 1/2"
BANDA-VENT	PQ17470		
BANDA-ALT-BA-AA	PQ17520	1997	
BANDA-ALT	PQ17520	BANDA-VENT	PQ17450
		BANDA-ALT-AA	2/9520PB
1992		BANDA-ALT-AA	PQ17520
BANDA-VENT	PQ17450	MANGUERA DE CALEFACCIÓN-	35B 5/8"
BANDA-VENT	PQ17470	MANGUERA DE CALEFACCIÓN-	CHARTER 3/4"
BANDA-ALT-BA-AA	PQ17520	MANGUERA INFERIOR-	CHARTER 2 1/2"
BANDA-ALT	PQ17530	MANGUERA INFERIOR-	CHARTER 3"
		MANGUERA SUPERIOR-	CHARTER 2 1/2"
1991			
BANDA-ALT-AA	PQ17530	1996	
BANDA-ALT	PQ17510	BANDA-VENT	8616 GS
BANDA-ALT	PQ17530	BANDA-ALT-AA	2/9520PB
BANDA-AA	8543 GS	BANDA-ALT-AA	PQ17520
BANDA-AA	8594 GS	MANGUERA DE CALEFACCIÓN-	35B 5/8"
BANDA-AA	PQ17540	MANGUERA DE CALEFACCIÓN-	CHARTER 3/4"
		MANGUERA INFERIOR-	CHARTER 2 1/2"
1990		MANGUERA INFERIOR-	CHARTER 3"
BANDA-VENT	8543 GS	MANGUERA SUPERIOR-	CHARTER 2 1/2"
BANDA-VENT	PQ17470		
BANDA-VENT	PQ17480	1995	
BANDA-ALT	PQ17510	BANDA-VENT	8616 GS
BANDA-AA	PQ17540	BANDA-ALT-AA	2/9520PB
		BANDA-ALT-AA	PQ17520
DETROIT DIESEL SERIE 60		MANGUERA DE CALEFACCIÓN-	35B 5/8"
2001		MANGUERA DE CALEFACCIÓN-	CHARTER 3/4"
POLEA-LOCA	38075	MANGUERA INFERIOR-	CHARTER 2 1/2"
TENSOR-	38501	MANGUERA INFERIOR-	CHARTER 3"
		MANGUERA SUPERIOR-	CHARTER 2 1/2"
1999			
BANDA-VENT	PQ17450		
BANDA-ALT-AA	2/9520PB	1994	
BANDA-ALT-AA	PQ17520	BANDA-VENT	2/9500PB
MANGUERA DE CALEFACCIÓN-	35B 5/8"	BANDA-VENT	PQ17450
MANGUERA DE CALEFACCIÓN-	CHARTER 3/4"	BANDA-VENT	PQ17470
MANGUERA INFERIOR-	CHARTER 2 1/2"	BANDA-VENT	PQ17490
MANGUERA INFERIOR-	CHARTER 3"	BANDA-VENT	PQ17500
MANGUERA SUPERIOR-	CHARTER 2 1/2"	BANDA-ALT-AA	2/9520PB



MASTER SERVICIO PESADO 2014

KENWORTH

T800

BANDA-ALT-AA	PQ17530	MANGUERA INFERIOR-	CHARTER 2 1/2"
BANDA-ALT	2/9500PB	MANGUERA SUPERIOR-	CHARTER 2 1/2"
BANDA-ALT	2/9510PB	1991	
BANDA-AA	8594 GS	BANDA-VENT	2/9500PB
BANDA-AA	PQ17520	BANDA-VENT	PQ17450
BANDA-AA	PQ17550	BANDA-VENT	PQ17470
MANGUERA DE CALEFACCIÓN-	CHARTER 3/4"	BANDA-VENT	PQ17490
MANGUERA INFERIOR-	CHARTER 2 1/2"	BANDA-VENT	PQ17500
MANGUERA INFERIOR-	CHARTER 3"	BANDA-ALT-AA	2/9520PB
MANGUERA SUPERIOR-	CHARTER 2 1/2"	BANDA-ALT-AA	PQ17530
1993		BANDA-ALT	2/9500PB
BANDA-VENT	2/9500PB	BANDA-ALT	2/9510PB
BANDA-VENT	PQ17450	BANDA-AA	8594 GS
BANDA-VENT	PQ17470	BANDA-AA	PQ17520
BANDA-VENT	PQ17490	BANDA-AA	PQ17550
BANDA-VENT	PQ17500	MANGUERA DE CALEFACCIÓN-	35B 5/8"
BANDA-ALT-AA	2/9520PB	MANGUERA DE PASO-	CHARTER 1 3/4"
BANDA-ALT-AA	PQ17530	MANGUERA INFERIOR-	CHARTER 2 1/2"
BANDA-ALT	2/9500PB	MANGUERA SUPERIOR-	CHARTER 2 1/2"
BANDA-ALT	2/9510PB	1990	
BANDA-AA	8594 GS	BANDA-VENT	2/9500PB
BANDA-AA	PQ17520	BANDA-VENT	PQ17450
BANDA-AA	PQ17550	BANDA-VENT	PQ17470
MANGUERA DE CALEFACCIÓN-	35B 5/8"	BANDA-VENT	PQ17490
MANGUERA DE PASO-	CHARTER 1 3/4"	BANDA-VENT	PQ17500
MANGUERA INFERIOR-	CHARTER 2 1/2"	BANDA-ALT-AA	2/9520PB
MANGUERA SUPERIOR-	CHARTER 2 1/2"	BANDA-ALT-AA	PQ17530
1992		BANDA-ALT	2/9500PB
BANDA-VENT	2/9500PB	BANDA-ALT	2/9510PB
BANDA-VENT	PQ17450	BANDA-AA	8594 GS
BANDA-VENT	PQ17470	BANDA-AA	PQ17520
BANDA-VENT	PQ17490	BANDA-AA	PQ17550
BANDA-VENT	PQ17500	MANGUERA DE CALEFACCIÓN-	35B 5/8"
BANDA-ALT-AA	2/9520PB	MANGUERA DE PASO-	CHARTER 1 3/4"
BANDA-ALT-AA	PQ17530	MANGUERA INFERIOR-	CHARTER 2 1/2"
BANDA-ALT	2/9500PB	MANGUERA SUPERIOR-	CHARTER 2 1/2"
BANDA-ALT	2/9510PB	DETROIT DIESEL 6 CIL, 12.7 L DIESEL	
BANDA-AA	8594 GS	2001	
BANDA-AA	PQ17520	BANDA-VENT	9447
BANDA-AA	PQ17550	MANGUERA INFERIOR-TUBO A RAD.	CHARTER 3"
MANGUERA DE CALEFACCIÓN-	35B 5/8"	MANGUERA SUPERIOR-TUBO A RAD.	CHARTER 2 1/2"
MANGUERA DE PASO-	CHARTER 1 3/4"	BANDA-TOMA DE FUERZA-ALT-AA	K080580
		POLEA DEL TENSOR-TOMA DE FUERZA-ALT-AA	38075



MASTER SERVICIO PESADO 2014

KENWORTH

T800

TENSOR-TOMA DE FUERZA-ALT-AA	38501	MANGUERA DE AGUA-	30T 3/4"
MANGUERA INFERIOR-MOTOR A TUBO	CHARTER 2 1/2"	MANGUERA DE AGUA-	30T 5/8"
MANGUERA SUPERIOR-MOTOR A TUBO	CHARTER 2 1/2"	MANGUERA SILICÓN-	SIH250363C
TERMOSTATO-190°	33599	1995	
2000		BANDA-VENT	9610
BANDA-VENT	9447	MANGUERA SILICÓN-TUBO A RAD.	SIH300363C
MANGUERA INFERIOR-TUBO A RAD.	CHARTER 3"	MANGUERA SILICÓN-MOTOR A TUBO	SIH250363C
MANGUERA SUPERIOR-TUBO A RAD.	CHARTER 2 1/2"	BANDA-ALT-AA	2/9520PB
BANDA-TOMA DE FUERZA-ALT-AA	K080580	BANDA-ALT-AA	9520
POLEA DEL TENSOR-TOMA DE FUERZA-ALT-AA	38075	TERMOSTATO-190°	33599
TENSOR-TOMA DE FUERZA-ALT-AA	38501	MANGUERA DE AGUA-	30T 3/4"
MANGUERA INFERIOR-MOTOR A TUBO	CHARTER 2 1/2"	MANGUERA DE AGUA-	30T 5/8"
MANGUERA SUPERIOR-MOTOR A TUBO	CHARTER 2 1/2"	MANGUERA SILICÓN-	SIH250363C
TERMOSTATO-190°	33599	1994	
1999		BANDA-VENT- OPCIONAL	9470
BANDA-VENT	9447	BANDA-VENT- OPCIONAL	9500
MANGUERA SILICÓN-TUBO A RAD.	SIH300363C	BANDA-VENT	3/9470PB
MANGUERA SILICÓN-MOTOR A TUBO	SIH250363C	BANDA-VENT	3/9500PB
BANDA-ALT-AA	2/9520PB	BANDA-VENT	9447
BANDA-ALT-AA	9520	BANDA-VENT	9490
TERMOSTATO-190°	33599	MANGUERA SILICÓN-TUBO A RAD.	SIH300363C
MANGUERA DE AGUA-	30T 3/4"	MANGUERA SILICÓN-MOTOR A TUBO	SIH250363C
MANGUERA DE AGUA-	30T 5/8"	BANDA-ALT-AA	2/9520PB
MANGUERA SILICÓN-	SIH250363C	BANDA-ALT-AA	9525
1998		BANDA-ALT	2/9500PB
TERMOSTATO-190°	33599	BANDA-ALT	2/9510PB
1997		TERMOSTATO-190°	33599
BANDA-VENT	9447	BANDA-	9520
MANGUERA SILICÓN-TUBO A RAD.	SIH300363C	BANDA-	9545
MANGUERA SILICÓN-MOTOR A TUBO	SIH250363C	BANDA-	9590
BANDA-ALT-AA	2/9520PB	MANGUERA DE AGUA-	30T 3/4"
BANDA-ALT-AA	9520	MANGUERA SILICÓN-	SIH250363C
TERMOSTATO-190°	33599	1993	
MANGUERA DE AGUA-	30T 3/4"	BANDA-VENT- OPCIONAL	9470
MANGUERA DE AGUA-	30T 5/8"	BANDA-VENT- OPCIONAL	9500
MANGUERA SILICÓN-	SIH250363C	BANDA-VENT	3/9470PB
1996		BANDA-VENT	3/9500PB
BANDA-VENT	9610	BANDA-VENT	9447
MANGUERA SILICÓN-TUBO A RAD.	SIH300363C	BANDA-VENT	9490
MANGUERA SILICÓN-MOTOR A TUBO	SIH250363C	BANDA-ALT-AA	2/9520PB
BANDA-ALT-AA	2/9520PB	BANDA-ALT-AA	9525
BANDA-ALT-AA	9520	BANDA-ALT	2/9510PB
TERMOSTATO-190°	33599	TERMOSTATO-190°	33599



MASTER SERVICIO PESADO 2014

KENWORTH

T800

BANDA-	9520	MANGUERA INFERIOR-TUBO A RAD.	CHARTER 3"
BANDA-	9545	MANGUERA SUPERIOR-TUBO A RAD.	CHARTER 2 1/2"
BANDA-	9590	BANDA-TOMA DE FUERZA-ALT-AA	K080580
MANGUERA DE AGUA-	30T 5/8"	POLEA DEL TENSOR-TOMA DE FUERZA-ALT-AA	38075
MANGUERA DE PASO-	CHARTER 1 3/4"	TENSOR-TOMA DE FUERZA-ALT-AA	38501
MANGUERA SILICÓN-	SIH250363C	MANGUERA INFERIOR-MOTOR A TUBO	CHARTER 2 1/2"
1992		MANGUERA SUPERIOR-MOTOR A TUBO	CHARTER 2 1/2"
BANDA-VENT- OPCIONAL	9470	TERMOSTATO-190°	33599
BANDA-VENT- OPCIONAL	9500	2000	
BANDA-VENT	3/9470PB	BANDA-VENT	9447
BANDA-VENT	3/9500PB	MANGUERA INFERIOR-TUBO A RAD.	CHARTER 3"
BANDA-VENT	9447	MANGUERA SUPERIOR-TUBO A RAD.	CHARTER 2 1/2"
BANDA-VENT	9490	BANDA-TOMA DE FUERZA-ALT-AA	K080580
BANDA-ALT-AA	2/9520PB	POLEA DEL TENSOR-TOMA DE FUERZA-ALT-AA	38075
BANDA-ALT-AA	9525	TENSOR-TOMA DE FUERZA-ALT-AA	38501
BANDA-ALT	2/9510PB	MANGUERA INFERIOR-MOTOR A TUBO	CHARTER 2 1/2"
TERMOSTATO-190°	33599	MANGUERA SUPERIOR-MOTOR A TUBO	CHARTER 2 1/2"
BANDA-	9520	TERMOSTATO-190°	33599
BANDA-	9545	1999	
BANDA-	9590	BANDA-VENT	9447
MANGUERA DE AGUA-	30T 5/8"	MANGUERA SILICÓN-TUBO A RAD.	SIH300363C
MANGUERA DE PASO-	CHARTER 1 3/4"	MANGUERA SILICÓN-MOTOR A TUBO	SIH250363C
MANGUERA SILICÓN-	SIH250363C	BANDA-ALT-AA	2/9520PB
1991		BANDA-ALT-AA	9520
BANDA-VENT- OPCIONAL	9470	TERMOSTATO-190°	33599
BANDA-VENT- OPCIONAL	9500	MANGUERA DE AGUA-	30T 3/4"
BANDA-VENT	3/9470PB	MANGUERA DE AGUA-	30T 5/8"
BANDA-VENT	3/9500PB	MANGUERA SILICÓN-	SIH250363C
BANDA-VENT	9447	1998	
BANDA-VENT	9490	BANDA-VENT	9447
BANDA-ALT-AA	2/9520PB	MANGUERA SILICÓN-TUBO A RAD.	SIH300363C
BANDA-ALT-AA	9525	MANGUERA SILICÓN-MOTOR A TUBO	SIH250363C
BANDA-ALT	2/9510PB	BANDA-ALT-AA	2/9520PB
TERMOSTATO-190°	33599	BANDA-ALT-AA	9520
BANDA-	9520	TERMOSTATO-190°	33599
BANDA-	9545	MANGUERA DE AGUA-	30T 3/4"
BANDA-	9590	MANGUERA DE AGUA-	30T 5/8"
MANGUERA DE AGUA-	30T 5/8"	MANGUERA SILICÓN-	SIH250363C
MANGUERA DE PASO-	CHARTER 1 3/4"	1997	
MANGUERA SILICÓN-	SIH250363C	BANDA-VENT	9447
DETROIT DIESEL 6 CIL, 11.1 L DIESEL		MANGUERA SILICÓN-TUBO A RAD.	SIH300363C
2001		MANGUERA SILICÓN-MOTOR A TUBO	SIH250363C
BANDA-VENT	9447	BANDA-ALT-AA	2/9520PB



MASTER SERVICIO PESADO 2014

KENWORTH

T800

BANDA-ALT-AA	9520	MANGUERA SILICÓN-	SIH250363C
TERMOSTATO-190°	33599	1993	
MANGUERA DE AGUA-	30T 3/4"	BANDA-VENT- OPCIONAL	9470
MANGUERA DE AGUA-	30T 5/8"	BANDA-VENT- OPCIONAL	9500
MANGUERA SILICÓN-	SIH250363C	BANDA-VENT	3/9470PB
1996		BANDA-VENT	3/9500PB
BANDA-VENT	9610	BANDA-VENT	9447
MANGUERA SILICÓN-TUBO A RAD.	SIH300363C	BANDA-VENT	9490
MANGUERA SILICÓN-MOTOR A TUBO	SIH250363C	BANDA-ALT-AA	2/9520PB
BANDA-ALT-AA	2/9520PB	BANDA-ALT-AA	9525
BANDA-ALT-AA	9520	BANDA-ALT	2/9510PB
TERMOSTATO-190°	33599	TERMOSTATO-190°	33599
MANGUERA DE AGUA-	30T 3/4"	BANDA-	9520
MANGUERA DE AGUA-	30T 5/8"	BANDA-	9545
MANGUERA SILICÓN-	SIH250363C	BANDA-	9590
1995		MANGUERA DE AGUA-	30T 5/8"
BANDA-VENT	9610	MANGUERA DE PASO-	CHARTER 1 3/4"
MANGUERA SILICÓN-TUBO A RAD.	SIH300363C	MANGUERA SILICÓN-	SIH250363C
MANGUERA SILICÓN-MOTOR A TUBO	SIH250363C	1992	
BANDA-ALT-AA	2/9520PB	BANDA-VENT- OPCIONAL	9470
BANDA-ALT-AA	9520	BANDA-VENT- OPCIONAL	9500
TERMOSTATO-190°	33599	BANDA-VENT	3/9470PB
MANGUERA DE AGUA-	30T 3/4"	BANDA-VENT	3/9500PB
MANGUERA DE AGUA-	30T 5/8"	BANDA-VENT	9447
MANGUERA SILICÓN-	SIH250363C	BANDA-VENT	9490
1994		BANDA-ALT-AA	2/9520PB
BANDA-VENT- OPCIONAL	9470	BANDA-ALT-AA	9525
BANDA-VENT- OPCIONAL	9500	BANDA-ALT	2/9510PB
BANDA-VENT	3/9470PB	TERMOSTATO-190°	33599
BANDA-VENT	3/9500PB	BANDA-	9520
BANDA-VENT	9447	BANDA-	9545
BANDA-VENT	9490	BANDA-	9590
MANGUERA SILICÓN-TUBO A RAD.	SIH300363C	MANGUERA DE AGUA-	30T 5/8"
MANGUERA SILICÓN-MOTOR A TUBO	SIH250363C	MANGUERA DE PASO-	CHARTER 1 3/4"
BANDA-ALT-AA	2/9520PB	MANGUERA SILICÓN-	SIH250363C
BANDA-ALT-AA	9525	1991	
BANDA-ALT	2/9500PB	BANDA-VENT- OPCIONAL	9470
BANDA-ALT	2/9510PB	BANDA-VENT- OPCIONAL	9500
TERMOSTATO-190°	33599	BANDA-VENT	3/9470PB
BANDA-	9520	BANDA-VENT	3/9500PB
BANDA-	9545	BANDA-VENT	9447
BANDA-	9590	BANDA-VENT	9490
MANGUERA DE AGUA-	30T 3/4"	BANDA-ALT-AA	2/9520PB



BANDA-ALT-AA	9525	BANDA-TOMA DE FUERZA-AA	PQ17420
BANDA-ALT	2/9510PB	MANGUERA SILICÓN-MOTOR A TUBO	SIH250363C
TERMOSTATO-190°	33599	MANGUERA SUPERIOR-MOTOR A TUBO	CHARTER 2 1/2"
BANDA-	9520	BANDA-ALT	9451
BANDA-	9545	BANDA-ALT	PQ17450
BANDA-	9590	TERMOSTATO-190°	33579
MANGUERA DE AGUA-	30T 5/8"	TERMOSTATO-180°	33576
MANGUERA DE PASO-	CHARTER 1 3/4"	TERMOSTATO-180°	33578
MANGUERA SILICÓN-	SIH250363C	TERMOSTATO-170°	33577
CUMMINS NTC 350		MANGUERA INFERIOR-	CHARTER 2 1/2"
1991		2001	
BANDA-VENT	PQ28412	MANGUERA SILICÓN-TUBO A RAD.	SIH250363C
BANDA-BA	K060436	MANGUERA SILICÓN-TUBO A RAD.	SIH300363C
BANDA-ALT	PQ17460	MANGUERA SUPERIOR-TUBO A RAD.	CHARTER 2 1/2"
CUMMINS N14 DIESEL		BANDA-TOMA DE FUERZA-VENT	PQ28437
2003		BANDA-TOMA DE FUERZA-VENT	TR28437
MANGUERA SILICÓN-TUBO A TUBO	SIH250363C	BANDA-TOMA DE FUERZA-BA	K060425
MANGUERA SILICÓN-TUBO A RAD.	SIH250363C	BANDA-TOMA DE FUERZA-AA	9425
MANGUERA SUPERIOR-TUBO A RAD.	CHARTER 2 1/2"	BANDA-TOMA DE FUERZA-AA	PQ17430
BANDA-TOMA DE FUERZA-VENT	PQ28463	MANGUERA SILICÓN-MOTOR A TUBO	SIH250363C
BANDA-TOMA DE FUERZA-VENT	TR28463	MANGUERA SUPERIOR-MOTOR A TUBO	CHARTER 2 1/2"
BANDA-TOMA DE FUERZA-BA	K060425	BANDA-ALT	9451
BANDA-TOMA DE FUERZA-AA	9425	BANDA-ALT	PQ17450
BANDA-TOMA DE FUERZA-AA	PQ17420	TERMOSTATO-190°	33579
MANGUERA SILICÓN-MOTOR A TUBO	SIH250363C	TERMOSTATO-180°	33576
MANGUERA SUPERIOR-MOTOR A TUBO	CHARTER 2 1/2"	TERMOSTATO-180°	33578
BANDA-ALT	9451	TERMOSTATO-170°	33577
BANDA-ALT	PQ17450	MANGUERA INFERIOR-	CHARTER 2 1/2"
TERMOSTATO-190°	33579	MANGUERA INFERIOR-	CHARTER 3"
TERMOSTATO-180°	33576	2000	
TERMOSTATO-180°	33578	MANGUERA SILICÓN-TUBO A RAD.	SIH250363C
TERMOSTATO-170°	33577	MANGUERA SILICÓN-TUBO A RAD.	SIH300363C
MANGUERA INFERIOR-	CHARTER 2 1/2"	MANGUERA SUPERIOR-TUBO A RAD.	CHARTER 2 1/2"
2002		BANDA-TOMA DE FUERZA-VENT	PQ28437
MANGUERA SILICÓN-TUBO A TUBO	SIH250363C	BANDA-TOMA DE FUERZA-VENT	TR28437
MANGUERA SILICÓN-TUBO A RAD.	SIH250363C	BANDA-TOMA DE FUERZA-BA	K060425
MANGUERA SUPERIOR-TUBO A RAD.	CHARTER 2 1/2"	BANDA-TOMA DE FUERZA-AA	9425
BANDA-TOMA DE FUERZA-VENT	PQ28437	BANDA-TOMA DE FUERZA-AA	PQ17430
BANDA-TOMA DE FUERZA-VENT	PQ28463	MANGUERA SILICÓN-MOTOR A TUBO	SIH250363C
BANDA-TOMA DE FUERZA-VENT	TR28437	MANGUERA SUPERIOR-MOTOR A TUBO	CHARTER 2 1/2"
BANDA-TOMA DE FUERZA-VENT	TR28463	BANDA-ALT	9451
BANDA-TOMA DE FUERZA-BA	K060425	BANDA-ALT	PQ17450
BANDA-TOMA DE FUERZA-AA	9425		



MASTER SERVICIO PESADO 2014

KENWORTH

T800

TERMOSTATO-190°	33579	MANGUERA INFERIOR-	CHARTER 2 1/2"
TERMOSTATO-180°	33576	MANGUERA INFERIOR-	CHARTER 3"
TERMOSTATO-180°	33578	1997	
TERMOSTATO-170°	33577	BANDA-TOMA DE FUERZA-VENT	PQ28483
MANGUERA INFERIOR-	CHARTER 2 1/2"	BANDA-TOMA DE FUERZA-VENT	TR28483
MANGUERA INFERIOR-	CHARTER 3"	BANDA-TOMA DE FUERZA-BA	K060425
1999		BANDA-TOMA DE FUERZA-AA	9425
MANGUERA SILICÓN-TUBO A RAD.	SIH250363C	BANDA-TOMA DE FUERZA-AA	PQ17430
MANGUERA SILICÓN-TUBO A RAD.	SIH300363C	BANDA-ALT	9463
MANGUERA SUPERIOR-TUBO A RAD.	CHARTER 2 1/2"	BANDA-ALT	PQ17460
BANDA-TOMA DE FUERZA-VENT	PQ28437	TERMOSTATO-190°	33579
BANDA-TOMA DE FUERZA-VENT	TR28437	TERMOSTATO-180°	33576
BANDA-TOMA DE FUERZA-BA	K060425	TERMOSTATO-180°	33578
BANDA-TOMA DE FUERZA-AA	9425	TERMOSTATO-170°	33577
BANDA-TOMA DE FUERZA-AA	PQ17430	1996	
MANGUERA SILICÓN-MOTOR A TUBO	SIH250363C	BANDA-VENT- OPCIONAL	TR28412
MANGUERA SUPERIOR-MOTOR A TUBO	CHARTER 2 1/2"	BANDA-VENT- OPCIONAL	TR28429
BANDA-ALT	9451	BANDA-VENT- OPCIONAL	TR28437
BANDA-ALT	PQ17450	BANDA-VENT	2/TR28411PB
TERMOSTATO-190°	33579	BANDA-VENT	2/TR28429PB
TERMOSTATO-180°	33576	BANDA-VENT	2/TR28437PB
TERMOSTATO-180°	33578	BANDA-VENT	K080415
TERMOSTATO-170°	33577	BANDA-VENT	K080427
MANGUERA INFERIOR-	CHARTER 2 1/2"	BANDA-VENT	K080465
MANGUERA INFERIOR-	CHARTER 3"	BANDA-VENT	PQ28400
1998		BANDA-VENT	PQ28412
MANGUERA SILICÓN-TUBO A RAD.	SIH250363C	BANDA-VENT	PQ28429
MANGUERA SILICÓN-TUBO A RAD.	SIH300363C	BANDA-VENT	PQ28437
MANGUERA SUPERIOR-TUBO A RAD.	CHARTER 2 1/2"	BANDA-VENT	TR28400
BANDA-TOMA DE FUERZA-VENT	PQ28437	MANGUERA SILICÓN-TUBO A RAD.	SIH300363C
BANDA-TOMA DE FUERZA-VENT	TR28437	MANGUERA SILICÓN-MOTOR A TUBO	SIH250363C
BANDA-TOMA DE FUERZA-BA	K060425	BANDA-BA	K040430
BANDA-TOMA DE FUERZA-AA	9425	BANDA-BA	K040445
BANDA-TOMA DE FUERZA-AA	PQ17430	BANDA-BA	K060425
MANGUERA SILICÓN-MOTOR A TUBO	SIH250363C	BANDA-BA	K060435
MANGUERA SUPERIOR-MOTOR A TUBO	CHARTER 2 1/2"	BANDA-ALT	2/9463PB
BANDA-ALT	9451	BANDA-ALT	2/9470PB
BANDA-ALT	PQ17450	BANDA-ALT	9463
TERMOSTATO-190°	33579	BANDA-ALT	9470
TERMOSTATO-180°	33576	BANDA-ALT	PQ17460
TERMOSTATO-180°	33578	BANDA-ALT	PQ17470
TERMOSTATO-170°	33577	BANDA-AA	PQ17400



MASTER SERVICIO PESADO 2014

KENWORTH

T800

BANDA-AA	PQ17420	TERMOSTATO-180°	33578
TERMOSTATO-190°	33579	TERMOSTATO-170°	33577
TERMOSTATO-180°	33576	BANDA-	9400
TERMOSTATO-180°	33578	BANDA-	9420
TERMOSTATO-170°	33577	MANGUERA INFERIOR-	CHARTER 2 1/2"
BANDA-	9400	MANGUERA INFERIOR-	CHARTER 3"
BANDA-	9420	MANGUERA SILICÓN-	SIH250363C
MANGUERA INFERIOR-	CHARTER 2 1/2"	MANGUERA SUPERIOR-	CHARTER 2 1/2"
MANGUERA INFERIOR-	CHARTER 3"	1994	
MANGUERA SILICÓN-	SIH250363C	BANDA-VENT- OPCIONAL	TR28412
MANGUERA SUPERIOR-	CHARTER 2 1/2"	BANDA-VENT- OPCIONAL	TR28429
1995		BANDA-VENT- OPCIONAL	TR28437
BANDA-VENT- OPCIONAL	TR28412	BANDA-VENT	2/TR28411PB
BANDA-VENT- OPCIONAL	TR28429	BANDA-VENT	2/TR28429PB
BANDA-VENT- OPCIONAL	TR28437	BANDA-VENT	2/TR28437PB
BANDA-VENT	2/TR28411PB	BANDA-VENT	K080415
BANDA-VENT	2/TR28429PB	BANDA-VENT	K080427
BANDA-VENT	2/TR28437PB	BANDA-VENT	K080465
BANDA-VENT	K080415	BANDA-VENT	PQ28400
BANDA-VENT	K080427	BANDA-VENT	PQ28412
BANDA-VENT	K080465	BANDA-VENT	PQ28429
BANDA-VENT	PQ28400	BANDA-VENT	PQ28437
BANDA-VENT	PQ28412	BANDA-VENT	TR28400
BANDA-VENT	PQ28429	MANGUERA SILICÓN-TUBO A RAD.	SIH300363C
BANDA-VENT	PQ28437	MANGUERA SILICÓN-MOTOR A TUBO	SIH250363C
BANDA-VENT	TR28400	BANDA-BA	K040430
MANGUERA SILICÓN-TUBO A RAD.	SIH300363C	BANDA-BA	K040445
MANGUERA SILICÓN-MOTOR A TUBO	SIH250363C	BANDA-BA	K060425
BANDA-BA	K040430	BANDA-BA	K060435
BANDA-BA	K040445	BANDA-ALT	2/9470PB
BANDA-BA	K060425	BANDA-ALT	9463
BANDA-BA	K060435	BANDA-ALT	9470
BANDA-ALT	2/9463PB	BANDA-ALT	PQ17460
BANDA-ALT	2/9470PB	BANDA-ALT	PQ17470
BANDA-ALT	9463	BANDA-AA	PQ17400
BANDA-ALT	9470	BANDA-AA	PQ17420
BANDA-ALT	PQ17460	TERMOSTATO-190°	33579
BANDA-ALT	PQ17470	TERMOSTATO-180°	33576
BANDA-AA	PQ17400	TERMOSTATO-180°	33578
BANDA-AA	PQ17420	TERMOSTATO-170°	33577
TERMOSTATO-190°	33579	BANDA-	9400
TERMOSTATO-180°	33576	BANDA-	9420



MASTER SERVICIO PESADO 2014

KENWORTH

T800

MANGUERA INFERIOR-	CHARTER 2 1/2"	1992	
MANGUERA INFERIOR-	CHARTER 3"	BANDA-VENT- OPCIONAL	TR28412
MANGUERA SILICÓN-	SIH250363C	BANDA-VENT- OPCIONAL	TR28429
MANGUERA SUPERIOR-	CHARTER 2 1/2"	BANDA-VENT- OPCIONAL	TR28437
1993		BANDA-VENT	2/TR28411PB
BANDA-VENT- OPCIONAL	TR28412	BANDA-VENT	2/TR28429PB
BANDA-VENT- OPCIONAL	TR28429	BANDA-VENT	2/TR28437PB
BANDA-VENT- OPCIONAL	TR28437	BANDA-VENT	K080415
BANDA-VENT	2/TR28411PB	BANDA-VENT	K080427
BANDA-VENT	2/TR28429PB	BANDA-VENT	K080465
BANDA-VENT	2/TR28437PB	BANDA-VENT	PQ28400
BANDA-VENT	K080415	BANDA-VENT	PQ28412
BANDA-VENT	K080427	BANDA-VENT	PQ28429
BANDA-VENT	K080465	BANDA-VENT	PQ28437
BANDA-VENT	PQ28400	BANDA-VENT	TR28400
BANDA-VENT	PQ28412	BANDA-BA	K040430
BANDA-VENT	PQ28429	BANDA-BA	K040445
BANDA-VENT	PQ28437	BANDA-BA	K060425
BANDA-VENT	TR28400	BANDA-BA	K060435
MANGUERA SILICÓN-TUBO A RAD.	SIH300363C	BANDA-ALT	2/9470PB
MANGUERA SILICÓN-MOTOR A TUBO	SIH250363C	BANDA-ALT	9463
BANDA-BA	K040430	BANDA-ALT	9470
BANDA-BA	K040445	BANDA-ALT	PQ17460
BANDA-BA	K060425	BANDA-ALT	PQ17470
BANDA-BA	K060435	BANDA-AA	PQ17400
BANDA-ALT	2/9470PB	BANDA-AA	PQ17420
BANDA-ALT	9463	TERMOSTATO-190°	33579
BANDA-ALT	9470	TERMOSTATO-180°	33576
BANDA-ALT	PQ17460	TERMOSTATO-180°	33578
BANDA-ALT	PQ17470	TERMOSTATO-170°	33577
BANDA-AA	PQ17400	BANDA-	9400
BANDA-AA	PQ17420	BANDA-	9420
TERMOSTATO-190°	33579	MANGUERA DE AGUA-	30T 5/8"
TERMOSTATO-180°	33576	MANGUERA DE CALEFACCIÓN-	35B 5/8"
TERMOSTATO-180°	33578	MANGUERA DE PASO-	CHARTER 1 1/2"
TERMOSTATO-170°	33577	MANGUERA INFERIOR-	CHARTER 1 1/4"
BANDA-	9400	MANGUERA INFERIOR-	CHARTER 2 1/2"
BANDA-	9420	MANGUERA SILICÓN-	SIH250363C
MANGUERA INFERIOR-	CHARTER 2 1/2"	MANGUERA SUPERIOR-	CHARTER 2 1/2"
MANGUERA INFERIOR-	CHARTER 3"	CUMMINS M11 DIESEL	
MANGUERA SILICÓN-	SIH250363C	2000	
MANGUERA SUPERIOR-	CHARTER 2 1/2"	MANGUERA SUPERIOR-TUBO A RAD.	CHARTER 2 1/2"
		BANDA-TOMA DE FUERZA-AA	PQ17530



MASTER SERVICIO PESADO 2014

KENWORTH

T800

MANGUERA SUPERIOR-MOTOR A TUBO	CHARTER 2 1/2"	TERMOSTATO-180°	33576
BANDA-ALT-VENT	K080708	TERMOSTATO-180°	33578
MANGUERA INFERIOR-	CHARTER 2 1/2"	TERMOSTATO-170°	33577
1998		BANDA-	9530
BANDA-VENT	K080485	MANGUERA INFERIOR-	CHARTER 2 1/2"
BANDA-ALT	K050345	MANGUERA INFERIOR-	CHARTER 3"
BANDA-AA	PQ17530	MANGUERA SILICÓN-	SIH250363C
TERMOSTATO-190°	33579	MANGUERA SUPERIOR-	CHARTER 2 1/2"
TERMOSTATO-180°	33576	1994	
TERMOSTATO-180°	33578	TERMOSTATO-190°	33579
TERMOSTATO-170°	33577	TERMOSTATO-180°	33576
BANDA-	9530	TERMOSTATO-180°	33578
1997		TERMOSTATO-170°	33577
BANDA-VENT	K080485	CUMMINS L10 DIESEL	
BANDA-ALT	K050345	1997	
BANDA-AA	PQ17530	BANDA-VENT	K080465
TERMOSTATO-190°	33579	BANDA-VENT	K080485
TERMOSTATO-180°	33576	BANDA-ALT	K050340
TERMOSTATO-180°	33578	BANDA-ALT	K050350
TERMOSTATO-170°	33577	BANDA-AA	8563 GS
BANDA-	9530	BANDA-AA	PQ17530
1996		TERMOSTATO-190°	33579
BANDA-VENT	K080485	TERMOSTATO-180°	33576
MANGUERA SILICÓN-TUBO A RAD.	SIH300363C	TERMOSTATO-180°	33578
MANGUERA SILICÓN-MOTOR A TUBO	SIH250363C	TERMOSTATO-175°	33960
BANDA-ALT	K050345	TERMOSTATO-170°	33577
BANDA-AA	PQ17530	BANDA-	9530
TERMOSTATO-190°	33579	BANDA-	9560
TERMOSTATO-180°	33576	1996	
TERMOSTATO-180°	33578	BANDA-VENT	K080465
TERMOSTATO-170°	33577	BANDA-VENT	K080485
BANDA-	9530	BANDA-ALT	K050340
MANGUERA INFERIOR-	CHARTER 2 1/2"	BANDA-ALT	K050350
MANGUERA INFERIOR-	CHARTER 3"	BANDA-AA	8563 GS
MANGUERA SILICÓN-	SIH250363C	BANDA-AA	PQ17530
MANGUERA SUPERIOR-	CHARTER 2 1/2"	TERMOSTATO-190°	33579
1995		TERMOSTATO-180°	33576
BANDA-VENT	K080485	TERMOSTATO-180°	33578
MANGUERA SILICÓN-TUBO A RAD.	SIH300363C	TERMOSTATO-175°	33960
MANGUERA SILICÓN-MOTOR A TUBO	SIH250363C	TERMOSTATO-170°	33577
BANDA-ALT	K050345	BANDA-	9530
BANDA-AA	PQ17530	BANDA-	9560
TERMOSTATO-190°	33579	1995	



MASTER SERVICIO PESADO 2014

KENWORTH

T800

BANDA-VENT	K080465	MANGUERA SILICÓN-TUBO A RAD.	SIH300363C
BANDA-VENT	K080485	MANGUERA SUPERIOR-TUBO A RAD.	CHARTER 2 1/2"
BANDA-ALT	K050340	MANGUERA SILICÓN-MOTOR A TUBO	SIH250363C
BANDA-ALT	K050350	MANGUERA SUPERIOR-MOTOR A TUBO	24436
BANDA-AA	8563 GS	MANGUERA SUPERIOR-MOTOR A TUBO	CHARTER 2 1/4"
BANDA-AA	PQ17530	BANDA-ALT	K050340
TERMOSTATO-190°	33579	BANDA-ALT	K050350
TERMOSTATO-180°	33576	BANDA-AA	8563 GS
TERMOSTATO-180°	33578	BANDA-AA	PQ17530
TERMOSTATO-175°	33960	TERMOSTATO-190°	33579
TERMOSTATO-170°	33577	TERMOSTATO-180°	33576
BANDA-	9530	TERMOSTATO-180°	33578
BANDA-	9560	TERMOSTATO-175°	33960
1994		TERMOSTATO-170°	33577
BANDA-VENT	K080465	BANDA-	9530
BANDA-VENT	K080485	BANDA-	9560
MANGUERA SILICÓN-TUBO A RAD.	SIH250363C	MANGUERA DE AGUA-	30T 5/8"
MANGUERA SILICÓN-TUBO A RAD.	SIH300363C	MANGUERA DE CALEFACCIÓN-	35B 5/8"
MANGUERA SUPERIOR-TUBO A RAD.	CHARTER 2 1/2"	MANGUERA INFERIOR-	CHARTER 1 1/4"
MANGUERA SILICÓN-MOTOR A TUBO	SIH250363C	MANGUERA INFERIOR-	CHARTER 2 1/2"
MANGUERA SUPERIOR-MOTOR A TUBO	24436	MANGUERA INFERIOR-	CHARTER 3"
MANGUERA SUPERIOR-MOTOR A TUBO	CHARTER 2 1/4"	1992	
BANDA-ALT	K050340	BANDA-VENT	K080465
BANDA-ALT	K050350	BANDA-VENT	K080485
BANDA-AA	8563 GS	MANGUERA SILICÓN-TUBO A RAD.	SIH250363C
BANDA-AA	PQ17530	MANGUERA SILICÓN-TUBO A RAD.	SIH300363C
TERMOSTATO-190°	33579	MANGUERA SUPERIOR-TUBO A RAD.	CHARTER 2 1/2"
TERMOSTATO-180°	33576	MANGUERA SILICÓN-MOTOR A TUBO	SIH250363C
TERMOSTATO-180°	33578	MANGUERA SUPERIOR-MOTOR A TUBO	24436
TERMOSTATO-175°	33960	MANGUERA SUPERIOR-MOTOR A TUBO	CHARTER 2 1/4"
TERMOSTATO-170°	33577	BANDA-ALT	K050340
BANDA-	9530	BANDA-ALT	K050350
BANDA-	9560	BANDA-AA	8563 GS
MANGUERA DE AGUA-	30T 5/8"	BANDA-AA	PQ17530
MANGUERA DE CALEFACCIÓN-	35B 5/8"	TERMOSTATO-190°	33579
MANGUERA INFERIOR-	CHARTER 1 1/4"	TERMOSTATO-180°	33576
MANGUERA INFERIOR-	CHARTER 2 1/2"	TERMOSTATO-180°	33578
MANGUERA INFERIOR-	CHARTER 3"	TERMOSTATO-175°	33960
1993		TERMOSTATO-170°	33577
BANDA-VENT	K080465	BANDA-	9530
BANDA-VENT	K080485	BANDA-	9560
MANGUERA SILICÓN-TUBO A RAD.	SIH250363C	MANGUERA DE AGUA-	30T 5/8"



MASTER SERVICIO PESADO 2014

KENWORTH

T800

MANGUERA DE CALEFACCIÓN-	35B 5/8"	MANGUERA INFERIOR-	CHARTER 3"
MANGUERA INFERIOR-	CHARTER 1 1/4"	CUMMINS ISX DIESEL	
MANGUERA INFERIOR-	CHARTER 2 1/2"	2014	
MANGUERA INFERIOR-	CHARTER 3"	BANDA-VENT-AA	K060637
1991		BANDA-VENT	K120858
BANDA-VENT	K080465	MANGUERA INFERIOR-TUBO A RAD.	21891
BANDA-VENT	K080485	MANGUERA SILICÓN-TUBO A RAD.	SIH250363C
MANGUERA SILICÓN-TUBO A RAD.	SIH250363C	TENSOR-TOMA DE FUERZA-ALT-AA	38610
MANGUERA SILICÓN-TUBO A RAD.	SIH300363C	MANGUERA SILICÓN-MOTOR A TUBO	SIH250363C
MANGUERA SUPERIOR-TUBO A RAD.	CHARTER 2 1/2"	MANGUERA SUPERIOR-MOTOR A TUBO	21891
MANGUERA SILICÓN-MOTOR A TUBO	SIH250363C	TENSOR-ALT-VENT	38587
MANGUERA SUPERIOR-MOTOR A TUBO	24436	TAPÓN DE RADIADOR-(15 LBS) SIN PALANCA	31350
MANGUERA SUPERIOR-MOTOR A TUBO	CHARTER 2 1/4"	BOMBA DE AGUA-	45051HD
BANDA-ALT	K050340	2013	
BANDA-ALT	K050350	BANDA-VENT-AA	K060637
BANDA-AA	8563 GS	BANDA-VENT	K120858
BANDA-AA	PQ17530	MANGUERA INFERIOR-TUBO A RAD.	21891
TERMOSTATO-190°	33579	MANGUERA SILICÓN-TUBO A RAD.	SIH250363C
TERMOSTATO-180°	33576	TENSOR-TOMA DE FUERZA-ALT-AA	38610
TERMOSTATO-180°	33578	MANGUERA SILICÓN-MOTOR A TUBO	SIH250363C
TERMOSTATO-175°	33960	MANGUERA SUPERIOR-MOTOR A TUBO	21891
TERMOSTATO-170°	33577	TENSOR-ALT-VENT	38587
BANDA-	9530	TAPÓN DE RADIADOR-(15 LBS) SIN PALANCA	31350
BANDA-	9560	BOMBA DE AGUA-	45051HD
MANGUERA DE AGUA-	30T 5/8"	2012	
MANGUERA DE CALEFACCIÓN-	35B 5/8"	MANGUERA INFERIOR-TUBO A RAD.	21891
MANGUERA INFERIOR-	CHARTER 1 1/4"	MANGUERA SILICÓN-TUBO A RAD.	SIH250363C
MANGUERA INFERIOR-	CHARTER 2 1/2"	TENSOR-TOMA DE FUERZA-ALT-AA	38610
MANGUERA INFERIOR-	CHARTER 3"	BANDA-TOMA DE FUERZA-AA	K060637
1990		MANGUERA SILICÓN-MOTOR A TUBO	SIH250363C
BANDA-VENT	K080465	MANGUERA SUPERIOR-MOTOR A TUBO	21891
BANDA-VENT	K080485	BANDA-ALT-VENT	K120872
MANGUERA SUPERIOR-TUBO A RAD.	CHARTER 2 1/2"	TENSOR-ALT-VENT	38587
MANGUERA SUPERIOR-MOTOR A TUBO	CHARTER 2 1/4"	TAPÓN DE RADIADOR-(15 LBS) SIN PALANCA	31350
BANDA-ALT	K050340	BOMBA DE AGUA-	45051HD
BANDA-ALT	K050350	2011	
BANDA-AA	8563 GS	MANGUERA INFERIOR-TUBO A RAD.	21891
BANDA-AA	PQ17530	MANGUERA SILICÓN-TUBO A RAD.	SIH250363C
TERMOSTATO-175°	33960	TENSOR-TOMA DE FUERZA-ALT-AA	38610
MANGUERA DE CALEFACCIÓN-	35B 5/8"	BANDA-TOMA DE FUERZA-AA	K060637
MANGUERA INFERIOR-	CHARTER 1 1/4"	MANGUERA SILICÓN-MOTOR A TUBO	SIH250363C
MANGUERA INFERIOR-	CHARTER 2 1/2"	MANGUERA SUPERIOR-MOTOR A TUBO	21891
		BANDA-ALT-VENT	K120872



MASTER SERVICIO PESADO 2014

KENWORTH

T800

TENSOR-ALT-VENT	38587	BOMBA DE AGUA-	45054HD
TAPÓN DE RADIADOR-(15 LBS) SIN PALANCA	31350	2006	
BOMBA DE AGUA-	45051HD	MANGUERA SILICÓN-TUBO A RAD.	SIH250363C
2010		MANGUERA SILICÓN-TUBO A RAD.	SIH300363C
MANGUERA INFERIOR-TUBO A RAD.	21891	BANDA-TOMA DE FUERZA-ALT-AA	K060637
MANGUERA SILICÓN-TUBO A RAD.	SIH250363C	TENSOR-TOMA DE FUERZA-ALT-AA	38610
TENSOR-TOMA DE FUERZA-ALT-AA	38610	MANGUERA SILICÓN-MOTOR A TUBO	SIH250363C
BANDA-TOMA DE FUERZA-AA	K060637	BANDA-ALT-VENT	K120864
MANGUERA SILICÓN-MOTOR A TUBO	SIH250363C	TENSOR-ALT-VENT	38587
MANGUERA SUPERIOR-MOTOR A TUBO	21891	TAPÓN DE RADIADOR-(15 LBS) SIN PALANCA	31350
BANDA-ALT-VENT	K120872	BOMBA DE AGUA-	45054HD
TENSOR-ALT-VENT	38587	2005	
TAPÓN DE RADIADOR-(15 LBS) SIN PALANCA	31350	MANGUERA SILICÓN-TUBO A RAD.	SIH250363C
BOMBA DE AGUA-	45051HD	MANGUERA SILICÓN-TUBO A RAD.	SIH300363C
2009		BANDA-TOMA DE FUERZA-ALT-AA	K060637
MANGUERA INFERIOR-TUBO A RAD.	21891	TENSOR-TOMA DE FUERZA-ALT-AA	38610
MANGUERA SILICÓN-TUBO A RAD.	SIH250363C	MANGUERA SILICÓN-MOTOR A TUBO	SIH250363C
TENSOR-TOMA DE FUERZA-ALT-AA	38610	BANDA-ALT-VENT	K120864
BANDA-TOMA DE FUERZA-AA	K060637	TENSOR-ALT-VENT	38587
MANGUERA SILICÓN-MOTOR A TUBO	SIH250363C	TAPÓN DE RADIADOR-(15 LBS) SIN PALANCA	31350
MANGUERA SUPERIOR-MOTOR A TUBO	21891	BOMBA DE AGUA-	45054HD
BANDA-ALT-VENT	K120872	2004	
TENSOR-ALT-VENT	38587	MANGUERA SILICÓN-TUBO A RAD.	SIH250363C
TAPÓN DE RADIADOR-(15 LBS) SIN PALANCA	31350	MANGUERA SILICÓN-TUBO A RAD.	SIH300363C
2008		TENSOR-TOMA DE FUERZA-ALT-AA	38610
MANGUERA INFERIOR-TUBO A RAD.	21891	BANDA-TOMA DE FUERZA-AA	K060637
MANGUERA SILICÓN-TUBO A RAD.	SIH250363C	MANGUERA SILICÓN-MOTOR A TUBO	SIH250363C
TENSOR-TOMA DE FUERZA-ALT-AA	38610	BANDA-ALT-VENT	K120864
BANDA-TOMA DE FUERZA-AA	K060637	TENSOR-ALT-VENT	38587
MANGUERA SILICÓN-MOTOR A TUBO	SIH250363C	TAPÓN DE RADIADOR-(15 LBS) SIN PALANCA	31350
MANGUERA SUPERIOR-MOTOR A TUBO	21891	BOMBA DE AGUA-	45054HD
BANDA-ALT-VENT	K120872	2003	
TENSOR-ALT-VENT	38587	BANDA-VENT	K100739
TAPÓN DE RADIADOR-(15 LBS) SIN PALANCA	31350	POLEA DEL TENSOR-VENT	36092
2007		TENSOR-VENT	38535
MANGUERA SILICÓN-TUBO A RAD.	SIH250363C	MANGUERA SILICÓN-TUBO A RAD.	SIH250363C
MANGUERA SILICÓN-TUBO A RAD.	SIH300363C	MANGUERA SUPERIOR FLEXIBLE-TUBO A RAD.	25T160 GS
BANDA-TOMA DE FUERZA-ALT-AA	K060637	BANDA-TOMA DE FUERZA-ALT-AA	K060685
TENSOR-TOMA DE FUERZA-ALT-AA	38610	POLEA DEL TENSOR-TOMA DE FUERZA-ALT-AA	36095
MANGUERA SILICÓN-MOTOR A TUBO	SIH250363C	TENSOR-TOMA DE FUERZA-ALT-AA	38532
BANDA-ALT-VENT-C/CUBIERTA CONVENSIONAL	K120864	MANGUERA SILICÓN-MOTOR A TUBO	SIH250363C
TENSOR-ALT-VENT	38587	MANGUERA SILICÓN-MOTOR A RAD.	SIH250363C
TAPÓN DE RADIADOR-(15 LBS) SIN PALANCA	31350	TAPÓN DE RADIADOR-(15 LBS) SIN PALANCA	31350



MASTER SERVICIO PESADO 2014

KENWORTH

T800

2002		BANDA-ALT-VENT	K080683
BANDA-VENT	K100658	TENSOR-ALT-VENT	38622
POLEA DEL TENSOR-VENT	36092	BANDA-AA	K060539
TENSOR-VENT	38535	TENSOR-AA	38505
MANGUERA SILICÓN-TUBO A RAD.	SIH250363C	TERMOSTATO-190°	33579
MANGUERA SILICÓN-TUBO A RAD.	SIH300363C	TERMOSTATO-180°	33576
BANDA-TOMA DE FUERZA-ALT-AA	K060685	TERMOSTATO-180°	33578
POLEA DEL TENSOR-TOMA DE FUERZA-ALT-AA	36095	TERMOSTATO-170°	33577
TENSOR-TOMA DE FUERZA-ALT-AA	38532	TAPÓN DE RADIADOR-(15 LBS) SIN PALANCA	31350
MANGUERA SILICÓN-MOTOR A TUBO	SIH250363C	2013	
TAPÓN DE RADIADOR-(15 LBS) SIN PALANCA	31350	BANDA-ALT-VENT	K080683
2001		TENSOR-ALT-VENT	38622
BANDA-VENT	K100658	BANDA-AA	K060539
POLEA DEL TENSOR-VENT	36092	TENSOR-AA	38505
TENSOR-VENT	38535	TERMOSTATO-190°	33579
MANGUERA SILICÓN-TUBO A RAD.	SIH250363C	TERMOSTATO-180°	33576
MANGUERA SILICÓN-TUBO A RAD.	SIH300363C	TERMOSTATO-180°	33578
BANDA-TOMA DE FUERZA-ALT-AA	K060685	TERMOSTATO-170°	33577
POLEA DEL TENSOR-TOMA DE FUERZA-ALT-AA	36095	TAPÓN DE RADIADOR-(15 LBS) SIN PALANCA	31350
TENSOR-TOMA DE FUERZA-ALT-AA	38532	2012	
MANGUERA SILICÓN-MOTOR A TUBO	SIH250363C	BANDA-ALT-VENT	K080683
2000		TENSOR-ALT-VENT	38622
BANDA-VENT	K100658	BANDA-AA	K060539
POLEA DEL TENSOR-VENT	36092	TENSOR-AA	38505
TENSOR-VENT	38535	TERMOSTATO-190°	33579
MANGUERA SILICÓN-TUBO A RAD.	SIH250363C	TERMOSTATO-180°	33576
MANGUERA SILICÓN-TUBO A RAD.	SIH300363C	TERMOSTATO-180°	33578
BANDA-TOMA DE FUERZA-ALT-AA	K060685	TERMOSTATO-170°	33577
POLEA DEL TENSOR-TOMA DE FUERZA-ALT-AA	36095	TAPÓN DE RADIADOR-(15 LBS) SIN PALANCA	31350
TENSOR-TOMA DE FUERZA-ALT-AA	38532	2011	
MANGUERA SILICÓN-MOTOR A TUBO	SIH250363C	BANDA-ALT-VENT	K080683
1999		TENSOR-ALT-VENT	38622
BANDA-VENT	K100658	BANDA-AA	K060539
POLEA DEL TENSOR-VENT	36092	TENSOR-AA	38505
TENSOR-VENT	38535	TERMOSTATO-190°	33579
MANGUERA SILICÓN-TUBO A RAD.	SIH250363C	TERMOSTATO-180°	33576
MANGUERA SILICÓN-TUBO A RAD.	SIH300363C	TERMOSTATO-180°	33578
BANDA-TOMA DE FUERZA-ALT-AA	K060685	TERMOSTATO-170°	33577
POLEA DEL TENSOR-TOMA DE FUERZA-ALT-AA	36095	TAPÓN DE RADIADOR-(15 LBS) SIN PALANCA	31350
TENSOR-TOMA DE FUERZA-ALT-AA	38532	2010	
MANGUERA SILICÓN-MOTOR A TUBO	SIH250363C	BANDA-ALT-VENT	K080683
CUMMINS ISM DIESEL		TENSOR-ALT-VENT	38622
2014		BANDA-AA	K060539



MASTER SERVICIO PESADO 2014

KENWORTH

T800

TENSOR-AA	38505	TENSOR-ALT-VENT	38622
TERMOSTATO-190°	33579	TAPÓN DE RADIADOR-(15 LBS) SIN PALANCA	31350
TERMOSTATO-180°	33576	POLEA DEL TENSOR-	36091
TERMOSTATO-180°	33578	2005	
TERMOSTATO-170°	33577	MANGUERA SILICÓN-TUBO A RAD.	SIH300363C
TAPÓN DE RADIADOR-(15 LBS) SIN PALANCA	31350	BANDA-TOMA DE FUERZA-AA	K060539
2009		TENSOR-TOMA DE FUERZA-AA	38505
BANDA-ALT-VENT	K080683	MANGUERA SILICÓN-RAD. A TUBO	SIH250363C
TENSOR-ALT-VENT	38622	MANGUERA SILICÓN-MOTOR A TUBO	SIH250363C
BANDA-AA	K060539	BANDA-ALT-VENT	K080702
TENSOR-AA	38505	TENSOR-ALT-VENT	38622
TERMOSTATO-190°	33579	TAPÓN DE RADIADOR-(15 LBS) SIN PALANCA	31350
TERMOSTATO-180°	33576	POLEA DEL TENSOR-	36091
TERMOSTATO-180°	33578	2004	
TERMOSTATO-170°	33577	MANGUERA SILICÓN-TUBO A RAD.	SIH300363C
TAPÓN DE RADIADOR-(15 LBS) SIN PALANCA	31350	BANDA-TOMA DE FUERZA-AA	K060539
2008		TENSOR-TOMA DE FUERZA-AA	38505
BANDA-ALT-VENT	K080683	MANGUERA SILICÓN-RAD. A TUBO	SIH250363C
TENSOR-ALT-VENT	38622	MANGUERA SILICÓN-MOTOR A TUBO	SIH250363C
BANDA-AA	K060539	BANDA-ALT-VENT	K080702
TENSOR-AA	38505	TENSOR-ALT-VENT	38521
TERMOSTATO-190°	33579	TAPÓN DE RADIADOR-(15 LBS) SIN PALANCA	31350
TERMOSTATO-180°	33576	POLEA DEL TENSOR-	36091
TERMOSTATO-180°	33578	2003	
TERMOSTATO-170°	33577	MANGUERA SILICÓN-TUBO A TUBO	SIH250363C
TAPÓN DE RADIADOR-(15 LBS) SIN PALANCA	31350	MANGUERA SILICÓN-TUBO A RAD.	SIH250363C
2007		BANDA-TOMA DE FUERZA-AA	K060539
MANGUERA SILICÓN-TUBO A RAD.	SIH300363C	TENSOR-TOMA DE FUERZA-AA	38505
BANDA-TOMA DE FUERZA-AA	K060539	MANGUERA SILICÓN-MOTOR A TUBO	SIH250363C
TENSOR-TOMA DE FUERZA-AA	38505	MANGUERA SUPERIOR-MOTOR A TUBO	24436
MANGUERA SILICÓN-RAD. A TUBO	SIH250363C	BANDA-ALT-VENT	K080716
MANGUERA SILICÓN-MOTOR A TUBO	SIH250363C	TENSOR-ALT-VENT	38521
BANDA-ALT-VENT	K080702	TAPÓN DE RADIADOR-(15 LBS) SIN PALANCA	31350
TENSOR-ALT-VENT	38622	POLEA DEL TENSOR-	36091
POLEA DEL TENSOR-AA	36091	2002	
TAPÓN DE RADIADOR-(15 LBS) SIN PALANCA	31350	MANGUERA INFERIOR-TUBO A RAD.	CHARTER 2 1/2"
2006		MANGUERA SUPERIOR-TUBO A RAD.	CHARTER 2 1/2"
MANGUERA SILICÓN-TUBO A RAD.	SIH300363C	BANDA-TOMA DE FUERZA-AA	9530
BANDA-TOMA DE FUERZA-AA	K060539	MANGUERA INFERIOR-MOTOR A TUBO	CHARTER 2 1/2"
TENSOR-TOMA DE FUERZA-AA	38505	MANGUERA SUPERIOR-MOTOR A TUBO	CHARTER 2 1/2"
MANGUERA SILICÓN-RAD. A TUBO	SIH250363C	BANDA-ALT-VENT	K080708
MANGUERA SILICÓN-MOTOR A TUBO	SIH250363C	TENSOR-ALT-VENT	38521
BANDA-ALT-VENT	K080702	TAPÓN DE RADIADOR-(15 LBS) SIN PALANCA	31350



MASTER SERVICIO PESADO 2014

KENWORTH

T800

2001

MANGUERA INFERIOR-TUBO A RAD.	CHARTER 2 1/2"	MANGUERA INFERIOR-TUBO A REFRIGERADOR	24436
MANGUERA SUPERIOR-TUBO A RAD.	CHARTER 2 1/2"	MANGUERA INFERIOR-RAD-TUBO	24452
BANDA-TOMA DE FUERZA-AA	9530	MANGUERA SUPERIOR-RAD-TUBO	24436
MANGUERA INFERIOR-MOTOR A TUBO	CHARTER 2 1/2"	MANGUERA SILICÓN-MOTOR A TUBO	SIH200363C
MANGUERA SUPERIOR-MOTOR A TUBO	CHARTER 2 1/2"	MANGUERA SUPERIOR-MOTOR A TUBO	24436
BANDA-ALT-VENT	K080708	MANGUERA SILICÓN-ENFRIADOR A TUBO	SIH250363C
TENSOR-ALT-VENT	38521	BANDA-ALT-BA-VENT	K080806
TAPÓN DE RADIADOR-(15 LBS) SIN PALANCA	31350	POLEA DEL TENSOR-ALT-BA-VENT	36093

2000

MANGUERA INFERIOR-TUBO A RAD.	CHARTER 2 1/2"	TAPÓN DE RADIADOR-(15 LBS) SIN PALANCA	31350
MANGUERA SUPERIOR-TUBO A RAD.	CHARTER 2 1/2"	BOMBA DE AGUA-	42146HD
BANDA-TOMA DE FUERZA-AA	9530	2007	
MANGUERA INFERIOR-MOTOR A TUBO	CHARTER 2 1/2"	BANDA-VENT-AA	8380 GS
MANGUERA SUPERIOR-MOTOR A TUBO	CHARTER 2 1/2"	MANGUERA INFERIOR-TUBO A ENFRIADOR	24436
BANDA-ALT-VENT	K080708	MANGUERA INFERIOR-RAD. A TUBO	24452
TENSOR-ALT-VENT	38521	MANGUERA SUPERIOR-RAD. A TUBO	24436
TAPÓN DE RADIADOR-(15 LBS) SIN PALANCA	31350	MANGUERA SILICÓN-MOTOR A TUBO	SIH200363C

1999

MANGUERA INFERIOR-TUBO A RAD.	CHARTER 2 1/2"	MANGUERA SUPERIOR-MOTOR A TUBO	24436
MANGUERA SUPERIOR-TUBO A RAD.	CHARTER 2 1/2"	MANGUERA SILICÓN-ENFRIADOR A TUBO	SIH250363C
BANDA-TOMA DE FUERZA-AA	9530	BANDA-ALT-BA-VENT	K080806
MANGUERA INFERIOR-MOTOR A TUBO	CHARTER 2 1/2"	POLEA DEL TENSOR-ALT-BA-VENT	36093
MANGUERA SUPERIOR-MOTOR A TUBO	CHARTER 2 1/2"	TENSOR-ALT-BA-VENT	38516
BANDA-ALT-VENT	K080708	TAPÓN DE RADIADOR-(15 LBS) SIN PALANCA	31350
TENSOR-ALT-VENT	38521	BOMBA DE AGUA-	42146HD
TAPÓN DE RADIADOR-(15 LBS) SIN PALANCA	31350	2006	

CUMMINS ISL DIESEL

2009

BANDA-VENT-AA	8380 GS	MANGUERA INFERIOR-TUBO A ENFRIADOR	24436
MANGUERA INFERIOR-TUBO A ENFRIADOR	24436	MANGUERA INFERIOR-RAD. A TUBO	24452
MANGUERA INFERIOR-RAD. A TUBO	24452	MANGUERA SUPERIOR-RAD. A TUBO	24436
MANGUERA SUPERIOR-RAD. A TUBO	24436	MANGUERA SILICÓN-MOTOR A TUBO	SIH200363C
MANGUERA SILICÓN-MOTOR A TUBO	SIH200363C	MANGUERA SUPERIOR-MOTOR A TUBO	24436
MANGUERA SUPERIOR-MOTOR A TUBO	24436	MANGUERA SILICÓN-ENFRIADOR A TUBO	SIH250363C
MANGUERA SILICÓN-ENFRIADOR A TUBO	SIH250363C	BANDA-ALT-BA-VENT	K080806
BANDA-ALT-BA-VENT	K080806	POLEA DEL TENSOR-ALT-BA-VENT	36093

2008

POLEA DEL TENSOR-ALT-BA-VENT	36093	TENSOR-ALT-BA-VENT	38516
TENSOR-ALT-BA-VENT	38516	TAPÓN DE RADIADOR-(15 LBS) SIN PALANCA	31350
TAPÓN DE RADIADOR-(15 LBS) SIN PALANCA	31350	BOMBA DE AGUA-	42146HD
BOMBA DE AGUA-	42146HD	2005	
2008		BANDA-VENT-AA	8468 GS
BANDA-VENT-AA	8380 GS	MANGUERA INFERIOR-TUBO A ENFRIADOR	24436
		MANGUERA INFERIOR-RAD. A TUBO	24452
		MANGUERA SUPERIOR-RAD. A TUBO	24436
		MANGUERA SILICÓN-MOTOR A TUBO	SIH200363C



MASTER SERVICIO PESADO 2014

KENWORTH

T800

MANGUERA SUPERIOR-MOTOR A TUBO	24436	TENSOR-ALT-BA-VENT	38516
MANGUERA SILICÓN-ENFRIADOR A TUBO	SIH250363C	TAPÓN DE RADIADOR-(15 LBS) SIN PALANCA	31350
BANDA-ALT-BA-VENT	K080716	BOMBA DE AGUA-	42146HD
POLEA DEL TENSOR-ALT-BA-VENT	36093	2001	
TENSOR-ALT-BA-VENT	38516	BANDA-VENT-AA	8468 GS
TAPÓN DE RADIADOR-(15 LBS) SIN PALANCA	31350	MANGUERA INFERIOR-TUBO A ENFRIADOR	24436
BOMBA DE AGUA-	42146HD	MANGUERA INFERIOR-RAD. A TUBO	24452
2004		MANGUERA SUPERIOR-RAD. A TUBO	24436
BANDA-VENT-AA	8468 GS	MANGUERA SILICÓN-MOTOR A TUBO	SIH200363C
MANGUERA INFERIOR-TUBO A ENFRIADOR	24436	MANGUERA SUPERIOR-MOTOR A TUBO	24436
MANGUERA INFERIOR-RAD. A TUBO	24452	MANGUERA SILICÓN-ENFRIADOR A TUBO	SIH250363C
MANGUERA SUPERIOR-RAD. A TUBO	24436	BANDA-ALT-BA-VENT	K080716
MANGUERA SILICÓN-MOTOR A TUBO	SIH200363C	POLEA DEL TENSOR-ALT-BA-VENT	36093
MANGUERA SUPERIOR-MOTOR A TUBO	24436	TENSOR-ALT-BA-VENT	38516
MANGUERA SILICÓN-ENFRIADOR A TUBO	SIH250363C	TAPÓN DE RADIADOR-(15 LBS) SIN PALANCA	31350
BANDA-ALT-BA-VENT	K080716	BOMBA DE AGUA-	42146HD
POLEA DEL TENSOR-ALT-BA-VENT	36093	CUMMINS ISL	
TENSOR-ALT-BA-VENT	38516	2006	
TAPÓN DE RADIADOR-(15 LBS) SIN PALANCA	31350	BANDA-VENT-AA	8380 GS
BOMBA DE AGUA-	42146HD	MANGUERA INFERIOR-TUBO A ENFRIADOR	24436
2003		MANGUERA SUPERIOR-RAD. A TUBO	24436
BANDA-VENT-AA	8468 GS	MANGUERA INFERIOR-MOTOR A TUBO	24432
MANGUERA INFERIOR-TUBO A ENFRIADOR	24436	MANGUERA SUPERIOR-MOTOR A TUBO	24436
MANGUERA INFERIOR-RAD. A TUBO	24452	MANGUERA INFERIOR-ENFRIADOR A TUBO	24440
MANGUERA SUPERIOR-RAD. A TUBO	24436	BANDA-ALT-BA-VENT	K080806
MANGUERA SILICÓN-MOTOR A TUBO	SIH200363C	POLEA-ALT-BA-VENT	36093
MANGUERA SUPERIOR-MOTOR A TUBO	24436	TENSOR-ALT-BA-VENT	38516
MANGUERA SILICÓN-ENFRIADOR A TUBO	SIH250363C	MANGUERA INFERIOR-	CHARTER 3 1/4"
BANDA-ALT-BA-VENT	K080716	2005	
POLEA DEL TENSOR-ALT-BA-VENT	36093	BANDA-VENT-AA	8468 GS
TENSOR-ALT-BA-VENT	38516	MANGUERA SUPERIOR-MOTOR A TUBO	CHARTER 2 1/4"
TAPÓN DE RADIADOR-(15 LBS) SIN PALANCA	31350	TENSOR-ALT-BA-VENT	38516
BOMBA DE AGUA-	42146HD	MANGUERA INFERIOR-	CHARTER 2 1/2"
2002		MANGUERA INFERIOR-	CHARTER 2 1/4"
BANDA-VENT-AA	8468 GS	MANGUERA INFERIOR-	CHARTER 2"
MANGUERA INFERIOR-TUBO A ENFRIADOR	24436	MANGUERA INFERIOR-	CHARTER 3 1/4"
MANGUERA INFERIOR-RAD. A TUBO	24452	CUMMINS 6 CIL, 14.0 L DIESEL	
MANGUERA SUPERIOR-RAD. A TUBO	24436	1991	
MANGUERA SILICÓN-MOTOR A TUBO	SIH200363C	BANDA-VENT- OPCIONAL	TR28412
MANGUERA SUPERIOR-MOTOR A TUBO	24436	BANDA-VENT- OPCIONAL	TR28429
MANGUERA SILICÓN-ENFRIADOR A TUBO	SIH250363C	BANDA-VENT- OPCIONAL	TR28437
BANDA-ALT-BA-VENT	K080716	BANDA-VENT	2/TR28411PB
POLEA DEL TENSOR-ALT-BA-VENT	36093	BANDA-VENT	2/TR28429PB



MASTER SERVICIO PESADO 2014

KENWORTH

T800

BANDA-VENT	2/TR28437PB	MANGUERA INFERIOR-TUBO A RAD.	CHARTER 3"
BANDA-VENT	K080415	MANGUERA SUPERIOR-TUBO A RAD.	CHARTER 2 1/2"
BANDA-VENT	K080427	MANGUERA INFERIOR-MOTOR A TUBO	CHARTER 3"
BANDA-VENT	K080465	MANGUERA SUPERIOR-MOTOR A TUBO	CHARTER 2 1/2"
BANDA-VENT	TR28400	BANDA-BA-VENT	TR22545
BANDA-BA	K040430	BANDA-ALT-VENT-AA	9620
BANDA-BA	K040445	TERMOSTATO-190°	33579
BANDA-BA	K060425	TERMOSTATO-180°	33576
BANDA-BA	K060435	TERMOSTATO-180°	33578
BANDA-ALT	2/9470PB	TERMOSTATO-170°	33577
BANDA-ALT	9463	2000	
BANDA-ALT	9470	MANGUERA SILICÓN-TUBO A RAD.	SIH250363C
TERMOSTATO-180°	33961	MANGUERA SILICÓN-TUBO A RAD.	SIH300363C
TERMOSTATO-180°	33962	MANGUERA SILICÓN-MOTOR A TUBO	SIH250363C
BANDA-	9400	MANGUERA SILICÓN-MOTOR A TUBO	SIH300363C
BANDA-	9420	BANDA-BA-VENT	TR22545
MANGUERA DE AGUA-	30T 5/8"	BANDA-ALT-VENT-AA	9620
MANGUERA DE PASO-	CHARTER 1 1/2"	TERMOSTATO-190°	33579
MANGUERA SILICÓN-	SIH250363C	TERMOSTATO-180°	33576
CATERPILLAR C16 DIESEL		TERMOSTATO-180°	33578
2003		TERMOSTATO-170°	33577
MANGUERA INFERIOR-TUBO A RAD.	CHARTER 3"	CATERPILLAR C15 DIESEL	
MANGUERA SUPERIOR-TUBO A RAD.	CHARTER 2 1/2"	2013	
MANGUERA INFERIOR-MOTOR A TUBO	CHARTER 3"	BANDA-VENT-AA-C/CUBIERTA CORTA	K120979
MANGUERA SUPERIOR-MOTOR A TUBO	CHARTER 2 1/2"	SENSOR-VENT-AA	38609
BANDA-BA-VENT	TR22545	MANGUERA SILICÓN-RAD. A TUBO	SIH250363C
BANDA-ALT-VENT-AA	9620	MANGUERA SILICÓN-RAD. A TUBO	SIH300363C
TERMOSTATO-190°	33579	MANGUERA SILICÓN-MOTOR A TUBO	SIH250363C
TERMOSTATO-180°	33576	MANGUERA SILICÓN-MOTOR A TUBO	SIH300363C
TERMOSTATO-180°	33578	BANDA-ALT-VENT-C/CUBIERTA CORTA	K060736
TERMOSTATO-170°	33577	SENSOR-ALT-VENT	38636
2002		TERMOSTATO-190°	33579
MANGUERA INFERIOR-TUBO A RAD.	CHARTER 3"	TERMOSTATO-180°	33576
MANGUERA SUPERIOR-TUBO A RAD.	CHARTER 2 1/2"	TERMOSTATO-180°	33578
MANGUERA INFERIOR-MOTOR A TUBO	CHARTER 3"	TERMOSTATO-170°	33577
MANGUERA SUPERIOR-MOTOR A TUBO	CHARTER 2 1/2"	TAPÓN DE RADIADOR-(15 LBS) SIN PALANCA	31350
BANDA-BA-VENT	TR22545	BOMBA DE AGUA-	44062HD
BANDA-ALT-VENT-AA	9620	2012	
TERMOSTATO-190°	33579	BANDA-VENT-AA-C/CUBIERTA CORTA	K120979
TERMOSTATO-180°	33576	SENSOR-VENT-AA	38609
TERMOSTATO-180°	33578	MANGUERA SILICÓN-RAD. A TUBO	SIH250363C
TERMOSTATO-170°	33577	MANGUERA SILICÓN-RAD. A TUBO	SIH300363C
2001		MANGUERA SILICÓN-MOTOR A TUBO	SIH250363C



MASTER SERVICIO PESADO 2014

KENWORTH

T800

MANGUERA SILICÓN-MOTOR A TUBO	SIH300363C	TENSOR-VENT-AA	38609
BANDA-ALT-VENT-C/CUBIERTA CORTA	K060736	MANGUERA SILICÓN-RAD. A TUBO	SIH250363C
TENSOR-ALT-VENT	38636	MANGUERA SILICÓN-RAD. A TUBO	SIH300363C
TERMOSTATO-190°	33579	MANGUERA SILICÓN-MOTOR A TUBO	SIH250363C
TERMOSTATO-180°	33576	MANGUERA SILICÓN-MOTOR A TUBO	SIH300363C
TERMOSTATO-180°	33578	BANDA-ALT-VENT-C/CUBIERTA CORTA	K120979
TERMOSTATO-170°	33577	BANDA-ALT-VENT-C/CUBIERTA CONVENSIONAL	K080934
TAPÓN DE RADIADOR-(15 LBS) SIN PALANCA	31350	BANDA-ALT-VENT-C/CUBIERTA CONVENSIONAL	K081023
BOMBA DE AGUA-	44062HD	TENSOR-ALT-VENT	38636
2011		TERMOSTATO-190°	33579
BANDA-VENT-AA-C/CUBIERTA CORTA	K120979	TERMOSTATO-180°	33576
TENSOR-VENT-AA	38609	TERMOSTATO-180°	33578
MANGUERA SILICÓN-RAD. A TUBO	SIH250363C	TERMOSTATO-170°	33577
MANGUERA SILICÓN-RAD. A TUBO	SIH300363C	TAPÓN DE RADIADOR-(15 LBS) SIN PALANCA	31350
MANGUERA SILICÓN-MOTOR A TUBO	SIH250363C	BOMBA DE AGUA-	44062HD
MANGUERA SILICÓN-MOTOR A TUBO	SIH300363C	2008	
BANDA-ALT-VENT-C/CUBIERTA CORTA	K060736	BANDA-VENT-AA-C/CUBIERTA CORTA	K060578
TENSOR-ALT-VENT	38636	BANDA-VENT-AA-C/CUBIERTA CONVENSIONAL	K060505
TERMOSTATO-190°	33579	BANDA-VENT-AA-C/CUBIERTA CONVENSIONAL	K060575
TERMOSTATO-180°	33576	TENSOR-VENT-AA	38609
TERMOSTATO-180°	33578	MANGUERA SILICÓN-RAD. A TUBO	SIH250363C
TERMOSTATO-170°	33577	MANGUERA SILICÓN-RAD. A TUBO	SIH300363C
TAPÓN DE RADIADOR-(15 LBS) SIN PALANCA	31350	MANGUERA SILICÓN-MOTOR A TUBO	SIH250363C
BOMBA DE AGUA-	44062HD	MANGUERA SILICÓN-MOTOR A TUBO	SIH300363C
2010		BANDA-ALT-VENT-C/CUBIERTA CORTA	K120979
BANDA-VENT-AA-C/CUBIERTA CORTA	K120979	BANDA-ALT-VENT-C/CUBIERTA CONVENSIONAL	K080934
TENSOR-VENT-AA	38609	BANDA-ALT-VENT-C/CUBIERTA CONVENSIONAL	K081023
MANGUERA SILICÓN-RAD. A TUBO	SIH250363C	TENSOR-ALT-VENT	38636
MANGUERA SILICÓN-RAD. A TUBO	SIH300363C	TERMOSTATO-190°	33579
MANGUERA SILICÓN-MOTOR A TUBO	SIH250363C	TERMOSTATO-180°	33576
MANGUERA SILICÓN-MOTOR A TUBO	SIH300363C	TERMOSTATO-180°	33578
BANDA-ALT-VENT-C/CUBIERTA CORTA	K060736	TERMOSTATO-170°	33577
TENSOR-ALT-VENT	38636	TAPÓN DE RADIADOR-(15 LBS) SIN PALANCA	31350
TERMOSTATO-190°	33579	BOMBA DE AGUA-	44062HD
TERMOSTATO-180°	33576	2007	
TERMOSTATO-180°	33578	BANDA-VENT-AA-C/CUBIERTA CORTA	K060578
TERMOSTATO-170°	33577	BANDA-VENT-AA-C/CUBIERTA CONVENSIONAL	K060505
TAPÓN DE RADIADOR-(15 LBS) SIN PALANCA	31350	BANDA-VENT-AA-C/CUBIERTA CONVENSIONAL	K060575
BOMBA DE AGUA-	44062HD	TENSOR-VENT-AA	38511
2009		MANGUERA SILICÓN-RAD. A TUBO	SIH250363C
BANDA-VENT-AA-C/CUBIERTA CORTA	K060578	MANGUERA SILICÓN-RAD. A TUBO	SIH300363C
BANDA-VENT-AA-C/CUBIERTA CONVENSIONAL	K060505	MANGUERA SILICÓN-MOTOR A TUBO	SIH250363C
BANDA-VENT-AA-C/CUBIERTA CONVENSIONAL	K060575		



MASTER SERVICIO PESADO 2014

KENWORTH

T800

MANGUERA SILICÓN-MOTOR A TUBO	SIH300363C	TERMOSTATO-180°	33576
POLEA-MOTOR	36091	TERMOSTATO-180°	33578
POLEA-MOTOR	36093	TERMOSTATO-170°	33577
BANDA-ALT-VENT-C/CUBIERTA CORTA	K120979	2004	
BANDA-ALT-VENT-C/CUBIERTA CONVENSIONAL	K080934	BANDA-VENT-AA-C/PURIF DE AIRE	K060569
BANDA-ALT-VENT-C/CUBIERTA CONVENSIONAL	K081023	POLEA DEL TENSOR-VENT-AA	36091
TENSOR-ALT-VENT-C/CUBIERTA CONVENSIONAL	38569	TENSOR-VENT-AA	38508
TERMOSTATO-190°	33579	MANGUERA INFERIOR-TUBO A RAD.	CHARTER 3"
TERMOSTATO-180°	33576	MANGUERA SUPERIOR-TUBO A RAD.	CHARTER 2 1/2"
TERMOSTATO-180°	33578	MANGUERA SILICÓN-RAD. A TUBO	SIH250363C
TERMOSTATO-170°	33577	MANGUERA INFERIOR-MOTOR A TUBO	CHARTER 3"
2006		MANGUERA SUPERIOR-MOTOR A TUBO	CHARTER 2 1/2"
BANDA-VENT-AA-C/CUBIERTA CORTA	K060578	POLEA-MOTOR	36091
BANDA-VENT-AA-C/CUBIERTA CONVENSIONAL	K060575	POLEA-MOTOR	36093
BANDA-VENT-AA	K060505	BANDA-BA-VENT	TR22545
TENSOR-VENT-AA	38511	BANDA-ALT-VENT-C/PURIF DE AIRE	K080842
MANGUERA SILICÓN-RAD. A TUBO	SIH250363C	BANDA-ALT-VENT-C/PURIF DE AIRE	K080893
MANGUERA SILICÓN-RAD. A TUBO	SIH300363C	BANDA-ALT-VENT-AA	9620
MANGUERA SILICÓN-MOTOR A TUBO	SIH250363C	POLEA-ALT-VENT	36091
MANGUERA SILICÓN-MOTOR A TUBO	SIH300363C	TENSOR-ALT-VENT	38506
POLEA-MOTOR	36091	TERMOSTATO-190°	33579
POLEA-MOTOR	36093	TERMOSTATO-180°	33576
BANDA-ALT-VENT-C/CUBIERTA CORTA	K120979	TERMOSTATO-180°	33578
BANDA-ALT-VENT-C/CUBIERTA CONVENSIONAL	K080934	TERMOSTATO-170°	33577
TENSOR-ALT-VENT-C/CUBIERTA CONVENSIONAL	38569	2003	
BANDA-ALT-VENT	K081023	MANGUERA INFERIOR-TUBO A RAD.	CHARTER 3"
TERMOSTATO-190°	33579	MANGUERA SUPERIOR-TUBO A RAD.	CHARTER 2 1/2"
TERMOSTATO-180°	33576	MANGUERA INFERIOR-MOTOR A TUBO	CHARTER 3"
TERMOSTATO-180°	33578	MANGUERA SUPERIOR-MOTOR A TUBO	CHARTER 2 1/2"
TERMOSTATO-170°	33577	BANDA-BA-VENT	TR22545
2005		BANDA-ALT-VENT-AA	9620
BANDA-VENT-AA	K060575	TERMOSTATO-190°	33579
TENSOR-VENT-AA	38511	TERMOSTATO-180°	33576
MANGUERA SILICÓN-RAD. A TUBO	SIH250363C	TERMOSTATO-180°	33578
MANGUERA SILICÓN-RAD. A TUBO	SIH300363C	TERMOSTATO-170°	33577
MANGUERA SILICÓN-MOTOR A TUBO	SIH250363C	2002	
MANGUERA SILICÓN-MOTOR A TUBO	SIH300363C	MANGUERA INFERIOR-TUBO A RAD.	CHARTER 3"
POLEA-MOTOR	36091	MANGUERA SUPERIOR-TUBO A RAD.	CHARTER 2 1/2"
POLEA-MOTOR	36093	MANGUERA INFERIOR-MOTOR A TUBO	CHARTER 3"
BANDA-ALT-VENT	K080934	MANGUERA SUPERIOR-MOTOR A TUBO	CHARTER 2 1/2"
TENSOR-ALT-VENT	38569	BANDA-BA-VENT	TR22545
TERMOSTATO-190°	33579	BANDA-ALT-VENT-AA	9620
		TERMOSTATO-190°	33579



MASTER SERVICIO PESADO 2014

KENWORTH

T800

TERMOSTATO-180°	33576	MANGUERA INFERIOR-RAD. A TUBO	21891
TERMOSTATO-180°	33578	MANGUERA SILICÓN-RAD. A TUBO	SIH250363C
TERMOSTATO-170°	33577	MANGUERA INFERIOR-MOTOR A TUBO	21891
2001		BANDA-ALT	K060858
MANGUERA INFERIOR-TUBO A RAD.	CHARTER 3"	SENSOR-ALT	38635
MANGUERA SUPERIOR-TUBO A RAD.	CHARTER 2 1/2"	TERMOSTATO-190°	33579
MANGUERA INFERIOR-MOTOR A TUBO	CHARTER 3"	TERMOSTATO-180°	33576
MANGUERA SUPERIOR-MOTOR A TUBO	CHARTER 2 1/2"	TERMOSTATO-180°	33578
BANDA-BA-VENT	TR22545	TERMOSTATO-170°	33577
BANDA-ALT-VENT-AA	9620	TAPÓN DE RADIADOR-(15 LBS) SIN PALANCA	31350
TERMOSTATO-190°	33579	MANGUERA SILICÓN-	SIH250363C
TERMOSTATO-180°	33576	2012	
TERMOSTATO-180°	33578	BANDA-VENT-AA	K100946
TERMOSTATO-170°	33577	SENSOR-VENT-AA	38646
2000		MANGUERA INFERIOR-RAD. A TUBO	21891
MANGUERA SILICÓN-TUBO A RAD.	SIH250363C	MANGUERA SILICÓN-RAD. A TUBO	SIH250363C
MANGUERA SILICÓN-TUBO A RAD.	SIH300363C	MANGUERA INFERIOR-MOTOR A TUBO	21891
MANGUERA SILICÓN-MOTOR A TUBO	SIH250363C	BANDA-ALT	K060858
MANGUERA SILICÓN-MOTOR A TUBO	SIH300363C	SENSOR-ALT	38635
BANDA-BA-VENT	TR22545	TERMOSTATO-190°	33579
BANDA-ALT-VENT-AA	9620	TERMOSTATO-180°	33576
TERMOSTATO-190°	33579	TERMOSTATO-180°	33578
TERMOSTATO-180°	33576	TERMOSTATO-170°	33577
TERMOSTATO-180°	33578	TAPÓN DE RADIADOR-(15 LBS) SIN PALANCA	31350
TERMOSTATO-170°	33577	MANGUERA SILICÓN-	SIH250363C
CATERPILLAR C13 DIESEL		2011	
2014		BANDA-VENT-AA	K100946
BANDA-VENT-AA	K100946	SENSOR-VENT-AA	38646
SENSOR-VENT-AA	38646	MANGUERA INFERIOR-RAD. A TUBO	21891
MANGUERA INFERIOR-RAD. A TUBO	21891	MANGUERA SILICÓN-RAD. A TUBO	SIH250363C
MANGUERA SILICÓN-RAD. A TUBO	SIH250363C	MANGUERA INFERIOR-MOTOR A TUBO	21891
MANGUERA INFERIOR-MOTOR A TUBO	21891	BANDA-ALT	K060858
BANDA-ALT	K060858	SENSOR-ALT	38635
SENSOR-ALT	38635	TERMOSTATO-190°	33579
TERMOSTATO-190°	33579	TERMOSTATO-180°	33576
TERMOSTATO-180°	33576	TERMOSTATO-180°	33578
TERMOSTATO-180°	33578	TERMOSTATO-170°	33577
TERMOSTATO-170°	33577	TAPÓN DE RADIADOR-(15 LBS) SIN PALANCA	31350
TAPÓN DE RADIADOR-(15 LBS) SIN PALANCA	31350	MANGUERA SILICÓN-	SIH250363C
MANGUERA SILICÓN-	SIH250363C	2010	
2013		BANDA-VENT-AA	K100946
BANDA-VENT-AA	K100946	SENSOR-VENT-AA	38646
SENSOR-VENT-AA	38646	MANGUERA INFERIOR-RAD. A TUBO	21891



MASTER SERVICIO PESADO 2014

KENWORTH

T800

MANGUERA SILICÓN-RAD. A TUBO	SIH250363C	POLEA-MOTOR	36093
MANGUERA INFERIOR-MOTOR A TUBO	21891	POLEA-MOTOR	36269
BANDA-ALT	K060858	POLEA-MOTOR	36341
TENSOR-ALT	38635	BANDA-ALT-VENT-AA	K080952
TERMOSTATO-190°	33579	TENSOR-ALT-VENT-AA	38590
TERMOSTATO-180°	33576	TERMOSTATO-190°	33579
TERMOSTATO-180°	33578	TERMOSTATO-180°	33576
TERMOSTATO-170°	33577	TERMOSTATO-180°	33578
TAPÓN DE RADIADOR-(15 LBS) SIN PALANCA	31350	TERMOSTATO-170°	33577
MANGUERA SILICÓN-	SIH250363C	POLEA DEL TENSOR-	36164
2009		2006	
BANDA-VENT-AA	K100946	MANGUERA SILICÓN-RAD. A TUBO	SIH250363C
TENSOR-VENT-AA	38646	MANGUERA SILICÓN-RAD. A TUBO	SIH300363C
MANGUERA INFERIOR-RAD. A TUBO	21891	MANGUERA SILICÓN-MOTOR A TUBO	SIH250363C
MANGUERA SILICÓN-RAD. A TUBO	SIH250363C	MANGUERA SILICÓN-MOTOR A RAD.	SIH300363C
MANGUERA INFERIOR-MOTOR A TUBO	21891	POLEA-MOTOR	36093
BANDA-ALT	K060858	POLEA-MOTOR	36269
TENSOR-ALT	38635	POLEA-MOTOR	36341
TERMOSTATO-190°	33579	BANDA-ALT-VENT-AA	K080952
TERMOSTATO-180°	33576	TENSOR-ALT-VENT-AA	38590
TERMOSTATO-180°	33578	TERMOSTATO-190°	33579
TERMOSTATO-170°	33577	TERMOSTATO-180°	33576
TAPÓN DE RADIADOR-(15 LBS) SIN PALANCA	31350	TERMOSTATO-180°	33578
MANGUERA SILICÓN-	SIH250363C	TERMOSTATO-170°	33577
2008		POLEA DEL TENSOR-	36164
BANDA-VENT-AA	K100946	2005	
TENSOR-VENT-AA	38646	MANGUERA SILICÓN-RAD. A TUBO	SIH250363C
MANGUERA INFERIOR-RAD. A TUBO	21891	MANGUERA SILICÓN-RAD. A TUBO	SIH300363C
MANGUERA SILICÓN-RAD. A TUBO	SIH250363C	MANGUERA SILICÓN-MOTOR A TUBO	SIH250363C
MANGUERA INFERIOR-MOTOR A TUBO	21891	MANGUERA SILICÓN-MOTOR A RAD.	SIH300363C
BANDA-ALT	K060858	POLEA-MOTOR	36093
TENSOR-ALT	38635	POLEA-MOTOR	36269
TERMOSTATO-190°	33579	POLEA-MOTOR	36341
TERMOSTATO-180°	33576	BANDA-ALT-VENT-AA	K080952
TERMOSTATO-180°	33578	TENSOR-ALT-VENT-AA	38590
TERMOSTATO-170°	33577	TERMOSTATO-190°	33579
TAPÓN DE RADIADOR-(15 LBS) SIN PALANCA	31350	TERMOSTATO-180°	33576
MANGUERA SILICÓN-	SIH250363C	TERMOSTATO-180°	33578
2007		TERMOSTATO-170°	33577
MANGUERA SILICÓN-RAD. A TUBO	SIH250363C	POLEA DEL TENSOR-	36164
MANGUERA SILICÓN-RAD. A TUBO	SIH300363C	2004	
MANGUERA SILICÓN-MOTOR A TUBO	SIH250363C	MANGUERA SILICÓN-RAD. A TUBO	SIH250363C
MANGUERA SILICÓN-MOTOR A RAD.	SIH300363C	MANGUERA SILICÓN-RAD. A TUBO	SIH300363C



MANGUERA SILICÓN-MOTOR A TUBO	SIH250363C	BANDA-TOMA DE FUERZA-ALT-VENT-C/CUBIERTA CORTA	K080806
MANGUERA SILICÓN-MOTOR A RAD.	SIH300363C	BANDA-TOMA DE FUERZA-ALT-VENT-C/CUBIERTA CONVENSIONAL	K080825
POLEA-MOTOR	36093	POLEA DEL TENSOR-TOMA DE FUERZA-ALT-VENT	36091
POLEA-MOTOR	36269	TENSOR-TOMA DE FUERZA-ALT-VENT	38506
POLEA-MOTOR	36341	MANGUERA SILICÓN-MOTOR A TUBO	SIH250363C
BANDA-ALT-VENT-AA	K080952	MANGUERA SILICÓN-MOTOR A TUBO	SIH300363C
TENSOR-ALT-VENT-AA	38590	POLEA-ALT-VENT	36091
TERMOSTATO-190°	33579	TERMOSTATO-190°	33579
TERMOSTATO-180°	33576	TERMOSTATO-180°	33576
TERMOSTATO-180°	33578	TERMOSTATO-180°	33578
TERMOSTATO-170°	33577	TERMOSTATO-170°	33577
POLEA DEL TENSOR-	36164	2001	
CATERPILLAR C12 DIESEL		BANDA-VENT-AA	9555
2004		MANGUERA SILICÓN-TUBO A RAD.	SIH250363C
BANDA-VENT-AA	9500	BANDA-TOMA DE FUERZA-ALT-VENT-C/CUBIERTA CORTA	K080806
MANGUERA SILICÓN-TUBO A RAD.	SIH250363C	BANDA-TOMA DE FUERZA-ALT-VENT-C/CUBIERTA CONVENSIONAL	K080825
MANGUERA SILICÓN-TUBO A RAD.	SIH300363C	POLEA DEL TENSOR-TOMA DE FUERZA-ALT-VENT	36091
BANDA-TOMA DE FUERZA-ALT-VENT	K080810	TENSOR-TOMA DE FUERZA-ALT-VENT	38506
POLEA DEL TENSOR-TOMA DE FUERZA-ALT-VENT	36091	MANGUERA SILICÓN-MOTOR A TUBO	SIH250363C
TENSOR-TOMA DE FUERZA-ALT-VENT	38506	MANGUERA SILICÓN-MOTOR A TUBO	SIH300363C
MANGUERA SILICÓN-MOTOR A TUBO	SIH250363C	TERMOSTATO-190°	33579
POLEA-ALT-VENT	36091	TERMOSTATO-180°	33576
TERMOSTATO-190°	33579	TERMOSTATO-180°	33578
TERMOSTATO-180°	33576	TERMOSTATO-170°	33577
TERMOSTATO-180°	33578	2000	
TERMOSTATO-170°	33577	BANDA-VENT-AA	9555
2003		MANGUERA SILICÓN-TUBO A RAD.	SIH250363C
BANDA-VENT-AA-C/PURIF DE AIRE	9500	MANGUERA SILICÓN-TUBO A RAD.	SIH300363C
BANDA-VENT-AA	9555	BANDA-TOMA DE FUERZA-ALT-VENT-C/CUBIERTA CORTA	K080806
MANGUERA SILICÓN-TUBO A RAD.	SIH250363C	BANDA-TOMA DE FUERZA-ALT-VENT-C/CUBIERTA CONVENSIONAL	K080825
MANGUERA SILICÓN-TUBO A RAD.	SIH300363C	POLEA DEL TENSOR-TOMA DE FUERZA-ALT-VENT	36091
BANDA-TOMA DE FUERZA-ALT-VENT-C/PURIF DE AIRE	K080810	TENSOR-TOMA DE FUERZA-ALT-VENT	38506
BANDA-TOMA DE FUERZA-ALT-VENT	K080797	MANGUERA SILICÓN-MOTOR A TUBO	SIH250363C
TENSOR-TOMA DE FUERZA-ALT-VENT	38506	POLEA-ALT-VENT	36091
MANGUERA SILICÓN-MOTOR A TUBO	SIH250363C	TERMOSTATO-190°	33579
POLEA-ALT-VENT	36091	TERMOSTATO-180°	33576
TERMOSTATO-190°	33579	TERMOSTATO-180°	33578
TERMOSTATO-180°	33576	TERMOSTATO-170°	33577
TERMOSTATO-180°	33578	1999	
TERMOSTATO-170°	33577	BANDA-VENT-AA	9555
2002		MANGUERA SILICÓN-TUBO A RAD.	SIH250363C
BANDA-VENT-AA	9555	MANGUERA SILICÓN-TUBO A RAD.	SIH300363C
MANGUERA SILICÓN-TUBO A RAD.	SIH250363C	BANDA-TOMA DE FUERZA-ALT-VENT	K080825



POLEA DEL TENSOR-TOMA DE FUERZA-ALT-VENT	36091	TERMOSTATO-180°	33578
TENSOR-TOMA DE FUERZA-ALT-VENT	38506	TERMOSTATO-170°	33577
MANGUERA SILICÓN-MOTOR A TUBO	SIH250363C	BANDA-	9555
TERMOSTATO-190°	33579	MANGUERA SILICÓN-	SIH250363C
TERMOSTATO-180°	33576	CATERPILLAR C11 DIESEL	
TERMOSTATO-180°	33578	2009	
TERMOSTATO-170°	33577	MANGUERA SILICÓN-RAD. A TUBO	SIH250363C
1998		MANGUERA SILICÓN-RAD. A TUBO	SIH300363C
MANGUERA SILICÓN-TUBO A RAD.	SIH300363C	MANGUERA SILICÓN-MOTOR A TUBO	SIH250363C
BANDA-TOMA DE FUERZA-ALT-VENT	K080825	MANGUERA SILICÓN-MOTOR A RAD.	SIH250363C
POLEA DEL TENSOR-TOMA DE FUERZA-ALT-VENT	36091	POLEA-MOTOR	36269
TENSOR-TOMA DE FUERZA-ALT-VENT	38506	POLEA-MOTOR	36341
MANGUERA SILICÓN-MOTOR A TUBO	SIH250363C	BANDA-ALT-VENT-AA	K080952
BANDA-ALT-VENT-AA	K080797	TENSOR-ALT-VENT-AA	38590
POLEA-ALT-VENT	36091	TERMOSTATO-190°	33579
TERMOSTATO-190°	33579	TERMOSTATO-180°	33576
TERMOSTATO-180°	33576	TERMOSTATO-180°	33578
TERMOSTATO-180°	33578	TERMOSTATO-170°	33577
TERMOSTATO-170°	33577	TAPÓN DE RADIADOR-(15 LBS) SIN PALANCA	31350
BANDA-	9555	POLEA DEL TENSOR-	36164
MANGUERA SILICÓN-	SIH250363C	2008	
1997		MANGUERA SILICÓN-RAD. A TUBO	SIH250363C
MANGUERA SILICÓN-TUBO A RAD.	SIH300363C	MANGUERA SILICÓN-RAD. A TUBO	SIH300363C
BANDA-TOMA DE FUERZA-ALT-VENT	K080825	MANGUERA SILICÓN-MOTOR A TUBO	SIH250363C
POLEA DEL TENSOR-TOMA DE FUERZA-ALT-VENT	36091	MANGUERA SILICÓN-MOTOR A RAD.	SIH250363C
TENSOR-TOMA DE FUERZA-ALT-VENT	38506	POLEA-MOTOR	36269
MANGUERA SILICÓN-MOTOR A TUBO	SIH250363C	POLEA-MOTOR	36341
POLEA-ALT-VENT	36091	BANDA-ALT-VENT-AA	K080952
TERMOSTATO-190°	33579	TENSOR-ALT-VENT-AA	38590
TERMOSTATO-180°	33576	TERMOSTATO-190°	33579
TERMOSTATO-180°	33578	TERMOSTATO-180°	33576
TERMOSTATO-170°	33577	TERMOSTATO-180°	33578
BANDA-	9555	TERMOSTATO-170°	33577
MANGUERA SILICÓN-	SIH250363C	TAPÓN DE RADIADOR-(15 LBS) SIN PALANCA	31350
1996		POLEA DEL TENSOR-	36164
MANGUERA SILICÓN-TUBO A RAD.	SIH300363C	2007	
BANDA-TOMA DE FUERZA-ALT-VENT	K080825	MANGUERA SILICÓN-RAD. A TUBO	SIH250363C
POLEA DEL TENSOR-TOMA DE FUERZA-ALT-VENT	36091	MANGUERA SILICÓN-RAD. A TUBO	SIH300363C
TENSOR-TOMA DE FUERZA-ALT-VENT	38506	MANGUERA SILICÓN-MOTOR A TUBO	SIH250363C
MANGUERA SILICÓN-MOTOR A TUBO	SIH250363C	MANGUERA SILICÓN-MOTOR A RAD.	SIH250363C
POLEA-ALT-VENT	36091	POLEA-MOTOR	36269
TERMOSTATO-190°	33579	POLEA-MOTOR	36341
TERMOSTATO-180°	33576	BANDA-ALT-VENT-AA	K080952



TENSOR-ALT-VENT-AA	38590	POLEA-MOTOR	36341
TERMOSTATO-190°	33579	BANDA-ALT-VENT-AA	K080952
TERMOSTATO-180°	33576	TENSOR-ALT-VENT-AA	38590
TERMOSTATO-180°	33578	TERMOSTATO-190°	33579
TERMOSTATO-170°	33577	TERMOSTATO-180°	33576
TAPÓN DE RADIADOR-(15 LBS) SIN PALANCA	31350	TERMOSTATO-180°	33578
POLEA DEL TENSOR-	36164	TERMOSTATO-170°	33577
2006		TAPÓN DE RADIADOR-(15 LBS) SIN PALANCA	31350
MANGUERA SILICÓN-RAD. A TUBO	SIH250363C	POLEA DEL TENSOR-	36164
MANGUERA SILICÓN-RAD. A TUBO	SIH300363C	2003	
MANGUERA SILICÓN-MOTOR A TUBO	SIH250363C	MANGUERA SILICÓN-RAD. A TUBO	SIH250363C
MANGUERA SILICÓN-MOTOR A RAD.	SIH250363C	MANGUERA SILICÓN-RAD. A TUBO	SIH300363C
POLEA-MOTOR	36269	MANGUERA SILICÓN-MOTOR A TUBO	SIH250363C
POLEA-MOTOR	36341	MANGUERA SILICÓN-MOTOR A RAD.	SIH250363C
BANDA-ALT-VENT-AA	K080952	POLEA-MOTOR	36269
TENSOR-ALT-VENT-AA	38590	POLEA-MOTOR	36341
TERMOSTATO-190°	33579	BANDA-ALT-VENT-AA	K080952
TERMOSTATO-180°	33576	TENSOR-ALT-VENT-AA	38590
TERMOSTATO-180°	33578	TERMOSTATO-190°	33579
TERMOSTATO-170°	33577	TERMOSTATO-180°	33576
TAPÓN DE RADIADOR-(15 LBS) SIN PALANCA	31350	TERMOSTATO-180°	33578
POLEA DEL TENSOR-	36164	TERMOSTATO-170°	33577
2005		TAPÓN DE RADIADOR-(15 LBS) SIN PALANCA	31350
MANGUERA SILICÓN-RAD. A TUBO	SIH250363C	POLEA DEL TENSOR-	36164
MANGUERA SILICÓN-RAD. A TUBO	SIH300363C	CATERPILLAR C10 DIESEL	
MANGUERA SILICÓN-MOTOR A TUBO	SIH250363C	2004	
MANGUERA SILICÓN-MOTOR A RAD.	SIH250363C	BANDA-VENT-AA	9500
POLEA-MOTOR	36269	MANGUERA SILICÓN-TUBO A RAD.	SIH250363C
POLEA-MOTOR	36341	MANGUERA SILICÓN-TUBO A RAD.	SIH300363C
BANDA-ALT-VENT-AA	K080952	BANDA-TOMA DE FUERZA-ALT-VENT	K080810
TENSOR-ALT-VENT-AA	38590	POLEA DEL TENSOR-TOMA DE FUERZA-ALT-VENT	36091
TERMOSTATO-190°	33579	TENSOR-TOMA DE FUERZA-ALT-VENT	38506
TERMOSTATO-180°	33576	MANGUERA SILICÓN-MOTOR A TUBO	SIH250363C
TERMOSTATO-180°	33578	POLEA-ALT-VENT	36091
TERMOSTATO-170°	33577	TERMOSTATO-190°	33579
TAPÓN DE RADIADOR-(15 LBS) SIN PALANCA	31350	TERMOSTATO-180°	33576
POLEA DEL TENSOR-	36164	TERMOSTATO-180°	33578
2004		TERMOSTATO-170°	33577
MANGUERA SILICÓN-RAD. A TUBO	SIH250363C	2003	
MANGUERA SILICÓN-RAD. A TUBO	SIH300363C	BANDA-VENT-AA-C/PURIF DE AIRE	9500
MANGUERA SILICÓN-MOTOR A TUBO	SIH250363C	BANDA-VENT-AA	9555
MANGUERA SILICÓN-MOTOR A RAD.	SIH250363C	MANGUERA SILICÓN-TUBO A RAD.	SIH250363C
POLEA-MOTOR	36269	MANGUERA SILICÓN-TUBO A RAD.	SIH300363C



MASTER SERVICIO PESADO 2014

KENWORTH

T800

BANDA-TOMA DE FUERZA-ALT-VENT-C/PURIF DE AIRE	K080810	TENSOR-TOMA DE FUERZA-ALT-VENT	38506
BANDA-TOMA DE FUERZA-ALT-VENT	K080797	MANGUERA SILICÓN-MOTOR A TUBO	SIH250363C
TENSOR-TOMA DE FUERZA-ALT-VENT	38506	MANGUERA SILICÓN-MOTOR A TUBO	SIH300363C
MANGUERA SILICÓN-MOTOR A TUBO	SIH250363C	POLEA-ALT-VENT	36091
POLEA-ALT-VENT	36091	TERMOSTATO-190°	33579
TERMOSTATO-190°	33579	TERMOSTATO-180°	33576
TERMOSTATO-180°	33576	TERMOSTATO-180°	33578
TERMOSTATO-180°	33578	TERMOSTATO-170°	33577
TERMOSTATO-170°	33577	1999	
2002		BANDA-VENT-AA	9555
BANDA-VENT-AA	9555	MANGUERA SILICÓN-TUBO A RAD.	SIH250363C
MANGUERA SILICÓN-TUBO A RAD.	SIH250363C	MANGUERA SILICÓN-TUBO A RAD.	SIH300363C
BANDA-TOMA DE FUERZA-ALT-VENT-C/CUBIERTA CORTA	K080806	BANDA-TOMA DE FUERZA-ALT-VENT	K080825
BANDA-TOMA DE FUERZA-ALT-VENT-C/CUBIERTA CONVENSIONAL	K080825	POLEA DEL TENSOR-TOMA DE FUERZA-ALT-VENT	36091
POLEA DEL TENSOR-TOMA DE FUERZA-ALT-VENT	36091	TENSOR-TOMA DE FUERZA-ALT-VENT	38506
TENSOR-TOMA DE FUERZA-ALT-VENT	38506	MANGUERA SILICÓN-MOTOR A TUBO	SIH250363C
MANGUERA SILICÓN-MOTOR A TUBO	SIH250363C	TERMOSTATO-190°	33579
MANGUERA SILICÓN-MOTOR A TUBO	SIH300363C	TERMOSTATO-180°	33576
POLEA-ALT-VENT	36091	TERMOSTATO-180°	33578
TERMOSTATO-190°	33579	TERMOSTATO-170°	33577
TERMOSTATO-180°	33576	1998	
TERMOSTATO-180°	33578	MANGUERA SILICÓN-TUBO A RAD.	SIH300363C
TERMOSTATO-170°	33577	BANDA-TOMA DE FUERZA-ALT-VENT	K080825
2001		POLEA DEL TENSOR-TOMA DE FUERZA-ALT-VENT	36091
BANDA-VENT-AA	9555	TENSOR-TOMA DE FUERZA-ALT-VENT	38506
MANGUERA SILICÓN-TUBO A RAD.	SIH250363C	MANGUERA SILICÓN-MOTOR A TUBO	SIH250363C
BANDA-TOMA DE FUERZA-ALT-VENT-C/CUBIERTA CORTA	K080806	POLEA-ALT-VENT	36091
BANDA-TOMA DE FUERZA-ALT-VENT-C/CUBIERTA CONVENSIONAL	K080825	TERMOSTATO-190°	33579
POLEA DEL TENSOR-TOMA DE FUERZA-ALT-VENT	36091	TERMOSTATO-180°	33576
TENSOR-TOMA DE FUERZA-ALT-VENT	38506	TERMOSTATO-180°	33578
MANGUERA SILICÓN-MOTOR A TUBO	SIH250363C	TERMOSTATO-170°	33577
MANGUERA SILICÓN-MOTOR A TUBO	SIH300363C	BANDA-	9555
POLEA-ALT-VENT	36091	MANGUERA SILICÓN-	SIH250363C
TERMOSTATO-190°	33579	1997	
TERMOSTATO-180°	33576	MANGUERA SILICÓN-TUBO A RAD.	SIH300363C
TERMOSTATO-180°	33578	BANDA-TOMA DE FUERZA-ALT-VENT	K080825
TERMOSTATO-170°	33577	POLEA DEL TENSOR-TOMA DE FUERZA-ALT-VENT	36091
2000		TENSOR-TOMA DE FUERZA-ALT-VENT	38506
BANDA-VENT-AA	9555	MANGUERA SILICÓN-MOTOR A TUBO	SIH250363C
MANGUERA SILICÓN-TUBO A RAD.	SIH250363C	POLEA-ALT-VENT	36091
BANDA-TOMA DE FUERZA-ALT-VENT-C/CUBIERTA CORTA	K080806	TERMOSTATO-190°	33579
BANDA-TOMA DE FUERZA-ALT-VENT-C/CUBIERTA CONVENSIONAL	K080825	TERMOSTATO-180°	33576
POLEA DEL TENSOR-TOMA DE FUERZA-ALT-VENT	36091	TERMOSTATO-180°	33578

TRANSPORTE



Limpiaparabrisas MegaVision HD

PRODUCTO
NUEVO

Estimado Distribuidor:

Se integran nuevos productos a nuestra Línea de Limpiaparabrisas MegaVision, creciendo nuestra cobertura hasta 40" cubriendo aplicaciones principalmente para Autobuses Foráneos, MetroBus y algunos Camiones COE que lo requieren.

NUEVO MegaVision HD (Empaque Sencillo)

Código	Descripción	Tipo
7500168047082	MegaVision WB HD 38"	Tornillo / Perno
7500168047099	MegaVision WB HD 38"	Gancho
7500168047105	MegaVision WB HD 40"	Tornillo / Perno
7500168047112	MegaVision WB HD 40"	Gancho

Para cualquier duda o comentario, favor de comunicarte al 2000-2796, a la dirección electrónica cg1232@gates.com o con su Gerente Regional de Ventas.

Desc@rg@ el **NUEVO** Catálogo Máster Automotriz 2012 de nuestro sitio Web:

http://www.gates.com.mx/catalogos_boletines.asp.



A DONDE QUIERA QUE VAYAS, ESTAMOS CONTIGO



MASTER SERVICIO PESADO 2014

KENWORTH

T800

TERMOSTATO-170°	33577	TERMOSTATO-190°	33579
BANDA-	9555	TERMOSTATO-180°	33576
MANGUERA SILICÓN-	SIH250363C	TERMOSTATO-180°	33578
1996		TERMOSTATO-170°	33577
MANGUERA SILICÓN-TUBO A RAD.	SIH300363C	MANGUERA DE AGUA-	30T 3/4"
MANGUERA SILICÓN-MOTOR A TUBO	SIH250363C	MANGUERA SILICÓN-	SIH250363C
TERMOSTATO-190°	33579	1997	
TERMOSTATO-180°	33576	BANDA-VENT	TR22545
TERMOSTATO-180°	33578	MANGUERA SILICÓN-TUBO A TUBO	SIH250363C
TERMOSTATO-170°	33577	MANGUERA SILICÓN-TUBO A RAD.	SIH250363C
MANGUERA SILICÓN-	SIH250363C	MANGUERA SILICÓN-MOTOR A TUBO	SIH300363C
CATERPILLAR 3406 DIESEL		BANDA-ALT-AA	2/9610PB
2000		BANDA-ALT-AA	9610
MANGUERA SILICÓN-TUBO A RAD.	SIH250363C	TERMOSTATO-190°	33579
MANGUERA SILICÓN-TUBO A RAD.	SIH300363C	TERMOSTATO-180°	33576
BANDA-TOMA DE FUERZA-VENT	TR22545	TERMOSTATO-180°	33578
MANGUERA SILICÓN-MOTOR A TUBO	SIH250363C	TERMOSTATO-170°	33577
MANGUERA SILICÓN-MOTOR A TUBO	SIH300363C	MANGUERA DE AGUA-	30T 3/4"
BANDA-ALT-VENT-AA	9620	MANGUERA SILICÓN-	SIH250363C
TERMOSTATO-190°	33579	1996	
TERMOSTATO-180°	33576	BANDA-VENT- OPCIONAL	TR22570
TERMOSTATO-180°	33578	BANDA-VENT- OPCIONAL	TR28437
TERMOSTATO-170°	33577	BANDA-VENT	2/TR22570PB
1999		BANDA-VENT	2/TR28437PB
MANGUERA SILICÓN-TUBO A TUBO	SIH250363C	BANDA-VENT	TR22545
MANGUERA SILICÓN-TUBO A RAD.	SIH250363C	BANDA-VENT	TR22625
MANGUERA SILICÓN-TUBO A RAD.	SIH300363C	MANGUERA SILICÓN-TUBO A TUBO	SIH250363C
BANDA-TOMA DE FUERZA-VENT	TR22545	MANGUERA SILICÓN-TUBO A RAD.	SIH250363C
MANGUERA SILICÓN-MOTOR A TUBO	SIH250363C	MANGUERA SILICÓN-MOTOR A TUBO	SIH300363C
MANGUERA SILICÓN-MOTOR A TUBO	SIH300363C	BANDA-ALT-AA	2/9610PB
BANDA-ALT-VENT-AA	9620	BANDA-ALT-AA	9580
TERMOSTATO-190°	33579	BANDA-ALT-AA	9610
TERMOSTATO-180°	33576	BANDA-ALT-AA	9620
TERMOSTATO-180°	33578	BANDA-ALT-AA	9650
TERMOSTATO-170°	33577	BANDA-ALT	2/9463PB
MANGUERA DE AGUA-	30T 3/4"	BANDA-ALT	9463
1998		TERMOSTATO-190°	33579
BANDA-VENT	TR22545	TERMOSTATO-180°	33576
MANGUERA SILICÓN-TUBO A TUBO	SIH250363C	TERMOSTATO-180°	33578
MANGUERA SILICÓN-TUBO A RAD.	SIH250363C	TERMOSTATO-170°	33577
MANGUERA SILICÓN-MOTOR A TUBO	SIH300363C	BANDA-	9425
BANDA-ALT-AA	2/9610PB	MANGUERA DE AGUA-	30T 3/4"
BANDA-ALT-AA	9610		



MASTER SERVICIO PESADO 2014

KENWORTH

T800

MANGUERA SILICÓN-	SIH250363C	BANDA-ALT-AA	9605
1995		BANDA-ALT-AA	9610
BANDA-VENT- OPCIONAL	TR22570	BANDA-ALT-AA	9620
BANDA-VENT- OPCIONAL	TR28437	BANDA-ALT-AA	9650
BANDA-VENT	2/TR22570PB	BANDA-ALT	2/9463PB
BANDA-VENT	2/TR28437PB	BANDA-ALT	9463
BANDA-VENT	TR22545	TERMOSTATO-190°	33579
BANDA-VENT	TR22625	TERMOSTATO-180°	33576
MANGUERA SILICÓN-TUBO A TUBO	SIH250363C	TERMOSTATO-180°	33578
MANGUERA SILICÓN-TUBO A RAD.	SIH250363C	TERMOSTATO-170°	33577
MANGUERA SILICÓN-MOTOR A TUBO	SIH300363C	BANDA-	9425
BANDA-ALT-AA	2/9520PB	MANGUERA DE AGUA-	30T 3/4"
BANDA-ALT-AA	2/9610PB	MANGUERA SILICÓN-	SIH250363C
BANDA-ALT-AA	9520	1993	
BANDA-ALT-AA	9580	BANDA-VENT- OPCIONAL	TR22570
BANDA-ALT-AA	9605	BANDA-VENT- OPCIONAL	TR28437
BANDA-ALT-AA	9610	BANDA-VENT	2/TR22570PB
BANDA-ALT-AA	9620	BANDA-VENT	2/TR28437PB
BANDA-ALT-AA	9650	BANDA-VENT	TR22545
BANDA-ALT	2/9463PB	BANDA-VENT	TR22625
BANDA-ALT	9463	MANGUERA SILICÓN-TUBO A TUBO	SIH250363C
TERMOSTATO-190°	33579	MANGUERA SILICÓN-TUBO A RAD.	SIH250363C
TERMOSTATO-180°	33576	MANGUERA SILICÓN-MOTOR A TUBO	SIH300363C
TERMOSTATO-180°	33578	BANDA-ALT-AA	2/9520PB
TERMOSTATO-170°	33577	BANDA-ALT-AA	2/9610PB
BANDA-	9425	BANDA-ALT-AA	9520
MANGUERA DE AGUA-	30T 3/4"	BANDA-ALT-AA	9580
MANGUERA SILICÓN-	SIH250363C	BANDA-ALT-AA	9605
1994		BANDA-ALT-AA	9610
BANDA-VENT- OPCIONAL	TR22570	BANDA-ALT-AA	9620
BANDA-VENT- OPCIONAL	TR28437	BANDA-ALT-AA	9650
BANDA-VENT	2/TR22570PB	BANDA-ALT	2/9463PB
BANDA-VENT	2/TR28437PB	BANDA-ALT	9463
BANDA-VENT	TR22545	TERMOSTATO-190°	33579
BANDA-VENT	TR22625	TERMOSTATO-180°	33576
MANGUERA SILICÓN-TUBO A TUBO	SIH250363C	TERMOSTATO-180°	33578
MANGUERA SILICÓN-TUBO A RAD.	SIH250363C	TERMOSTATO-170°	33577
MANGUERA SILICÓN-MOTOR A TUBO	SIH300363C	BANDA-	9425
BANDA-ALT-AA	2/9520PB	MANGUERA DE AGUA-	30T 3/4"
BANDA-ALT-AA	2/9610PB	MANGUERA SILICÓN-	SIH250363C
BANDA-ALT-AA	9520	1992	
BANDA-ALT-AA	9580	BANDA-VENT- OPCIONAL	TR22570



MASTER SERVICIO PESADO 2014

KENWORTH

T800

BANDA-VENT- OPCIONAL	TR28437	TERMOSTATO-180°	33576
BANDA-VENT	2/TR22570PB	TERMOSTATO-180°	33578
BANDA-VENT	2/TR28437PB	TERMOSTATO-170°	33577
BANDA-VENT	TR22545	BANDA-	9425
BANDA-VENT	TR22625	MANGUERA DE AGUA-	30T 5/8"
BANDA-ALT-AA	2/9520PB	MANGUERA DE PASO-	CHARTER 1"
BANDA-ALT-AA	2/9610PB	MANGUERA SILICÓN-	SIH250363C
BANDA-ALT-AA	9520	MANGUERA SILICÓN-	SIH300363C
BANDA-ALT-AA	9580	1990	
BANDA-ALT-AA	9605	BANDA-VENT	2/TR28437PB
BANDA-ALT-AA	9610	BANDA-VENT	PQ24545
BANDA-ALT-AA	9620	BANDA-VENT	PQ24570
BANDA-ALT-AA	9650	BANDA-VENT	PQ28437
BANDA-ALT	2/9463PB	BANDA-VENT	TR22625
BANDA-ALT	9463	BANDA-ALT-AA	2/9520PB
TERMOSTATO-190°	33579	BANDA-ALT-AA	2/9610PB
TERMOSTATO-180°	33576	BANDA-ALT-AA	8580 GS
TERMOSTATO-180°	33578	BANDA-ALT-AA	8608 GS
TERMOSTATO-170°	33577	BANDA-ALT-AA	8650 GS
BANDA-	9425	BANDA-ALT-AA	9610
MANGUERA DE AGUA-	30T 5/8"	BANDA-ALT-AA	9620
MANGUERA DE PASO-	CHARTER 1"	BANDA-ALT-AA	PQ17520
MANGUERA SILICÓN-	SIH250363C	BANDA-ALT	2/9463PB
MANGUERA SILICÓN-	SIH300363C	BANDA-ALT	PQ17460
1991		BANDA-AA	PQ17430
BANDA-VENT- OPCIONAL	TR22570	TERMOSTATO-175°	33549
BANDA-VENT- OPCIONAL	TR28437	MANGUERA DE CALEFACCIÓN-	35B 5/8"
BANDA-VENT	2/TR22570PB	MANGUERA DE PASO-	CHARTER 1"
BANDA-VENT	2/TR28437PB	MANGUERA INFERIOR-	CHARTER 3"
BANDA-VENT	TR22545	MANGUERA SUPERIOR-	CHARTER 2 1/2"
BANDA-VENT	TR22625	CATERPILLAR 3306 DIESEL	
BANDA-ALT-AA	2/9520PB	1995	
BANDA-ALT-AA	2/9610PB	TERMOSTATO-175°	33549
BANDA-ALT-AA	9520	1994	
BANDA-ALT-AA	9580	TERMOSTATO-175°	33549
BANDA-ALT-AA	9605	1993	
BANDA-ALT-AA	9610	TERMOSTATO-175°	33549
BANDA-ALT-AA	9620	1992	
BANDA-ALT-AA	9650	BANDA-VENT- OPCIONAL	9470
BANDA-ALT	2/9463PB	BANDA-VENT	2/9470PB
BANDA-ALT	9463	BANDA-ALT	9530
TERMOSTATO-190°	33579	TERMOSTATO-175°	33549
		BANDA-	9540



MASTER SERVICIO PESADO 2014

KENWORTH

T800

MANGUERA DE AGUA-	30T 5/8"	BANDA-	9540
MANGUERA DE PASO-	CHARTER 1"	BANDA-	9560
MANGUERA SILICÓN-	SIH250363C	1993	
1991		MANGUERA SILICÓN-TUBO A TUBO	SIH250363C
BANDA-VENT- OPCIONAL	9470	MANGUERA SILICÓN-TUBO A RAD.	SIH300363C
BANDA-VENT	2/9470PB	MANGUERA INFERIOR-MOTOR A TUBO	24436
BANDA-ALT	9530	MANGUERA SILICÓN-MOTOR A TUBO	SIH200363C
TERMOSTATO-175°	33549	BANDA-ALT-VENT	K080675
BANDA-	9540	BANDA-ALT-VENT	K080680
MANGUERA DE AGUA-	30T 5/8"	BANDA-ALT-VENT	K080700
MANGUERA DE PASO-	CHARTER 1"	TERMOSTATO-190°	33579
MANGUERA SILICÓN-	SIH250363C	TERMOSTATO-180°	33576
1990		TERMOSTATO-180°	33578
BANDA-VENT	2/9470PB	TERMOSTATO-170°	33577
BANDA-VENT	PQ17470	BANDA-	9505
BANDA-ALT	PQ17530	BANDA-	9540
BANDA-AA	PQ17540	BANDA-	9560
TERMOSTATO-175°	33549	MANGUERA DE AGUA-	30T 5/8"
MANGUERA DE CALEFACCIÓN-	35B 5/8"	MANGUERA DE CALEFACCIÓN-	CHARTER 1"
MANGUERA DE PASO-	CHARTER 1"	1992	
MANGUERA INFERIOR-	CHARTER 2 1/2"	MANGUERA INFERIOR-TUBO A RAD.	24436
MANGUERA SUPERIOR-	CHARTER 2 1/2"	MANGUERA SILICÓN-TUBO A RAD.	SIH250363C
CATERPILLAR 3176 DIESEL		MANGUERA INFERIOR-MOTOR A TUBO	24436
1995		MANGUERA SILICÓN-MOTOR A TUBO	SIH200363C
BANDA-ALT-VENT	K080675	BANDA-ALT-VENT	K080675
BANDA-ALT-VENT	K080680	BANDA-ALT-VENT	K080680
BANDA-ALT-VENT	K080700	BANDA-ALT-VENT	K080700
TERMOSTATO-190°	33579	TERMOSTATO-190°	33579
TERMOSTATO-180°	33576	TERMOSTATO-180°	33576
TERMOSTATO-180°	33578	TERMOSTATO-180°	33578
TERMOSTATO-170°	33577	TERMOSTATO-170°	33577
BANDA-	9505	BANDA-	9505
BANDA-	9540	BANDA-	9540
BANDA-	9560	BANDA-	9560
1994		MANGUERA DE AGUA-	30T 5/8"
BANDA-ALT-VENT	K080675	MANGUERA DE CALEFACCIÓN-	CHARTER 1"
BANDA-ALT-VENT	K080680	1991	
BANDA-ALT-VENT	K080700	MANGUERA INFERIOR-TUBO A RAD.	24436
TERMOSTATO-190°	33579	MANGUERA SILICÓN-TUBO A RAD.	SIH250363C
TERMOSTATO-180°	33576	MANGUERA INFERIOR-MOTOR A TUBO	24436
TERMOSTATO-180°	33578	MANGUERA SILICÓN-MOTOR A TUBO	SIH200363C
TERMOSTATO-170°	33577	BANDA-ALT-VENT	K080675
BANDA-	9505	BANDA-ALT-VENT	K080680



MASTER SERVICIO PESADO 2014

KENWORTH

T800

BANDA-ALT-VENT	K080700	1990	
TERMOSTATO-190°	33579	BANDA-VENT	PQ17490
TERMOSTATO-180°	33576	BANDA-VENT	PQ17540
TERMOSTATO-180°	33578	BANDA-ALT	PQ17510
TERMOSTATO-170°	33577	DETROIT DIESEL SERIE 60, 11.1 L	
BANDA-	9505	1996	
BANDA-	9540	BANDA-VENT	PQ17470
BANDA-	9560	BANDA-VENT	PQ17490
MANGUERA DE AGUA-	30T 5/8"	BANDA-ALT 130A	PQ17530
MANGUERA DE CALEFACCIÓN-	CHARTER 1"	BANDA-ALT 100A/ALT 105A	PQ17520
W900		1995	
DETROIT DIESEL SERIE 60, 12.7 L		BANDA-VENT	PQ17470
1996		BANDA-VENT	PQ17490
BANDA-VENT	PQ17470	BANDA-ALT 130A	PQ17530
BANDA-VENT	PQ17490	BANDA-ALT 100A/ALT 105A	PQ17520
BANDA-ALT 130A	PQ17530	1994	
BANDA-ALT 100A/ALT 105A	PQ17520	BANDA-VENT	PQ17470
1995		BANDA-VENT	PQ17490
BANDA-VENT	PQ17470	BANDA-ALT 130A	PQ17530
BANDA-VENT	PQ17490	BANDA-ALT 100A/ALT 105A	PQ17520
BANDA-ALT 130A	PQ17530	1993	
BANDA-ALT 100A/ALT 105A	PQ17520	BANDA-VENT	PQ17470
1994		BANDA-VENT	PQ17490
BANDA-VENT	PQ17470	BANDA-ALT 130A	PQ17530
BANDA-VENT	PQ17490	BANDA-ALT 100A/ALT 105A	PQ17520
BANDA-ALT 130A	PQ17530	1992	
BANDA-ALT 100A/ALT 105A	PQ17520	BANDA-VENT	PQ17470
1993		BANDA-VENT	PQ17490
BANDA-VENT	PQ17470	BANDA-ALT 130A	PQ17530
BANDA-VENT	PQ17490	BANDA-ALT 100A/ALT 105A	PQ17520
BANDA-ALT 130A	PQ17530	1991	
BANDA-ALT 100A/ALT 105A	PQ17520	BANDA-VENT	PQ17470
1992		BANDA-VENT	PQ17490
BANDA-VENT	PQ17470	BANDA-ALT	PQ17510
BANDA-VENT	PQ17490	BANDA-AA	PQ17520
BANDA-ALT 130A	PQ17530	BANDA-AA	PQ17540
BANDA-ALT 100A/ALT 105A	PQ17520	1990	
1991		BANDA-VENT	PQ17490
BANDA-VENT	PQ17470	BANDA-VENT	PQ17540
BANDA-VENT	PQ17490	BANDA-ALT	PQ17510
BANDA-ALT	PQ17510	DETROIT DIESEL SERIE 60	
BANDA-AA	PQ17520	2000	
BANDA-AA	PQ17540	BANDA-VENT	PQ17470
		MANGUERA SUPERIOR-TUBO A RAD.	CHARTER 2 1/2"



MASTER SERVICIO PESADO 2014

KENWORTH

W900

MANGUERA SUPERIOR-MOTOR A TUBO	CHARTER 2 1/2"	1994	
BANDA-ALT-BA-AA	K080580	MANGUERA DE CALEFACCIÓN-	35B 5/8"
MANGUERA INFERIOR-	CHARTER 2 1/2"	MANGUERA DE CALEFACCIÓN-	CHARTER 3/4"
1999		MANGUERA INFERIOR-	CHARTER 2 1/2"
BANDA-VENT	PQ17470	MANGUERA INFERIOR-	CHARTER 3"
BANDA-ALT-AA	2/9520PB	MANGUERA SUPERIOR-	CHARTER 2 1/2"
BANDA-ALT-AA	PQ17520	1993	
MANGUERA DE CALEFACCIÓN-	35B 5/8"	BANDA-VENT	2/9490PB
MANGUERA DE CALEFACCIÓN-	CHARTER 3/4"	BANDA-VENT	PQ17490
MANGUERA INFERIOR-	CHARTER 2 1/2"	BANDA-ALT-BA-AA	2/9510PB
MANGUERA INFERIOR-	CHARTER 3"	BANDA-ALT-BA-AA	PQ17510
MANGUERA SUPERIOR-	CHARTER 2 1/2"	BANDA-ALT	2/9500PB
1998		BANDA-AA	8594 GS
BANDA-VENT	PQ17470	BANDA-AA	PQ17550
BANDA-ALT-AA	2/9520PB	MANGUERA DE CALEFACCIÓN-	35B 5/8"
BANDA-ALT-AA	PQ17520	MANGUERA DE PASO-	CHARTER 1 3/4"
MANGUERA DE CALEFACCIÓN-	35B 5/8"	MANGUERA INFERIOR-	CHARTER 2 1/2"
MANGUERA DE CALEFACCIÓN-	CHARTER 3/4"	MANGUERA SUPERIOR-	CHARTER 2 1/2"
MANGUERA INFERIOR-	CHARTER 2 1/2"	1992	
MANGUERA INFERIOR-	CHARTER 3"	BANDA-VENT	2/9490PB
MANGUERA SUPERIOR-	CHARTER 2 1/2"	BANDA-VENT	PQ17490
1997		BANDA-ALT-BA-AA	2/9510PB
BANDA-VENT	PQ17470	BANDA-ALT-BA-AA	PQ17510
BANDA-ALT-AA	2/9520PB	BANDA-ALT	2/9500PB
BANDA-ALT-AA	PQ17520	BANDA-AA	8594 GS
MANGUERA DE CALEFACCIÓN-	35B 5/8"	BANDA-AA	PQ17550
MANGUERA DE CALEFACCIÓN-	CHARTER 3/4"	MANGUERA DE CALEFACCIÓN-	35B 5/8"
MANGUERA INFERIOR-	CHARTER 2 1/2"	MANGUERA DE PASO-	CHARTER 1 3/4"
MANGUERA INFERIOR-	CHARTER 3"	MANGUERA INFERIOR-	CHARTER 2 1/2"
MANGUERA SUPERIOR-	CHARTER 2 1/2"	MANGUERA SUPERIOR-	CHARTER 2 1/2"
1996		1991	
BANDA-ALT	2/9325PB	BANDA-VENT	2/9490PB
MANGUERA DE CALEFACCIÓN-	35B 5/8"	BANDA-VENT	PQ17490
MANGUERA DE CALEFACCIÓN-	CHARTER 3/4"	BANDA-ALT-BA-AA	2/9510PB
MANGUERA INFERIOR-	CHARTER 2 1/2"	BANDA-ALT-BA-AA	PQ17510
MANGUERA INFERIOR-	CHARTER 3"	BANDA-ALT	2/9500PB
MANGUERA SUPERIOR-	CHARTER 2 1/2"	BANDA-AA	8594 GS
1995		BANDA-AA	PQ17550
MANGUERA DE CALEFACCIÓN-	35B 5/8"	MANGUERA DE CALEFACCIÓN-	35B 5/8"
MANGUERA DE CALEFACCIÓN-	CHARTER 3/4"	MANGUERA DE PASO-	CHARTER 1 3/4"
MANGUERA INFERIOR-	CHARTER 2 1/2"	MANGUERA INFERIOR-	CHARTER 2 1/2"
MANGUERA INFERIOR-	CHARTER 3"	MANGUERA SUPERIOR-	CHARTER 2 1/2"
MANGUERA SUPERIOR-	CHARTER 2 1/2"	1990	



MASTER SERVICIO PESADO 2014

KENWORTH

W900

BANDA-VENT	2/9490PB	BANDA-VENT- OPCIONAL	9470
BANDA-VENT	PQ17490	BANDA-VENT	3/9470PB
BANDA-ALT-BA-AA	2/9510PB	MANGUERA SILICÓN-TUBO A RAD.	SIH300363C
BANDA-ALT-BA-AA	PQ17510	MANGUERA SILICÓN-MOTOR A TUBO	SIH250363C
BANDA-ALT	2/9500PB	BANDA-ALT-AA	2/9520PB
BANDA-AA	8594 GS	BANDA-ALT-AA	9520
BANDA-AA	PQ17550	TERMOSTATO-190°	33599
MANGUERA DE CALEFACCIÓN-	35B 5/8"	MANGUERA DE AGUA-	30T 3/4"
MANGUERA DE PASO-	CHARTER 1 3/4"	MANGUERA DE AGUA-	30T 5/8"
MANGUERA INFERIOR-	CHARTER 2 1/2"	MANGUERA SILICÓN-	SIH250363C
MANGUERA SUPERIOR-	CHARTER 2 1/2"	1997	
DETROIT DIESEL 6 CIL, 12.7 L DIESEL		BANDA-VENT- OPCIONAL	9470
2001		BANDA-VENT	3/9470PB
BANDA-VENT- OPCIONAL	9470	MANGUERA SILICÓN-TUBO A RAD.	SIH300363C
BANDA-VENT	3/9470PB	MANGUERA SILICÓN-MOTOR A TUBO	SIH250363C
MANGUERA INFERIOR-TUBO A RAD.	CHARTER 2 1/2"	BANDA-ALT-AA	2/9520PB
MANGUERA SUPERIOR-TUBO A RAD.	CHARTER 2 1/2"	BANDA-ALT-AA	9520
BANDA-TOMA DE FUERZA-ALT-AA	K080580	TERMOSTATO-190°	33599
POLEA DEL TENSOR-TOMA DE FUERZA-ALT-AA	38075	MANGUERA DE AGUA-	30T 3/4"
TENSOR-TOMA DE FUERZA-ALT-AA	38501	MANGUERA DE AGUA-	30T 5/8"
MANGUERA INFERIOR-MOTOR A TUBO	CHARTER 2 1/2"	MANGUERA SILICÓN-	SIH250363C
MANGUERA SUPERIOR-MOTOR A TUBO	CHARTER 2 1/2"	1996	
2000		BANDA-VENT- OPCIONAL	9470
BANDA-VENT- OPCIONAL	9470	BANDA-VENT	3/9470PB
BANDA-VENT	3/9470PB	MANGUERA SILICÓN-TUBO A RAD.	SIH300363C
MANGUERA SILICÓN-TUBO A RAD.	SIH250363C	MANGUERA SILICÓN-MOTOR A TUBO	SIH250363C
BANDA-TOMA DE FUERZA-ALT-AA	K080580	BANDA-ALT-AA	2/9520PB
POLEA DEL TENSOR-TOMA DE FUERZA-ALT-AA	38075	BANDA-ALT-AA	9520
TENSOR-TOMA DE FUERZA-ALT-AA	38501	BANDA-ALT	2/9325PB
MANGUERA SILICÓN-MOTOR A TUBO	SIH250363C	TERMOSTATO-190°	33599
TERMOSTATO-190°	33599	MANGUERA DE AGUA-	30T 3/4"
1999		MANGUERA DE AGUA-	30T 5/8"
BANDA-VENT- OPCIONAL	9470	MANGUERA SILICÓN-	SIH250363C
BANDA-VENT	3/9470PB	1995	
MANGUERA SILICÓN-TUBO A RAD.	SIH300363C	BANDA-VENT- OPCIONAL	9470
MANGUERA SILICÓN-MOTOR A TUBO	SIH250363C	BANDA-VENT	3/9470PB
BANDA-ALT-AA	2/9520PB	MANGUERA SILICÓN-TUBO A RAD.	SIH300363C
BANDA-ALT-AA	9520	MANGUERA SILICÓN-MOTOR A TUBO	SIH250363C
TERMOSTATO-190°	33599	BANDA-ALT-AA	2/9520PB
MANGUERA DE AGUA-	30T 3/4"	BANDA-ALT-AA	9520
MANGUERA DE AGUA-	30T 5/8"	TERMOSTATO-190°	33599
MANGUERA SILICÓN-	SIH250363C	MANGUERA DE AGUA-	30T 3/4"
1998		MANGUERA DE AGUA-	30T 5/8"



MANGUERA SILICÓN-	SIH250363C	BANDA-	9545
1994		BANDA-	9590
BANDA-VENT- OPCIONAL	9470	MANGUERA DE AGUA-	30T 5/8"
BANDA-VENT	3/9470PB	MANGUERA DE PASO-	CHARTER 1 3/4"
MANGUERA SILICÓN-TUBO A RAD.	SIH300363C	MANGUERA SILICÓN-	SIH250363C
MANGUERA SILICÓN-MOTOR A TUBO	SIH250363C	DETROIT DIESEL 6 CIL, 11.1 L DIESEL	
BANDA-ALT-AA	2/9520PB	2006	
BANDA-ALT-AA	9520	TERMOSTATO-190°	33599
TERMOSTATO-190°	33599	2005	
MANGUERA DE AGUA-	30T 3/4"	TERMOSTATO-190°	33599
MANGUERA DE AGUA-	30T 5/8"	2004	
MANGUERA SILICÓN-	SIH250363C	TERMOSTATO-190°	33599
1993		2003	
BANDA-VENT- OPCIONAL	9490	TERMOSTATO-190°	33599
BANDA-VENT	2/9490PB	2002	
BANDA-ALT-BA-AA	2/9510PB	TERMOSTATO-190°	33599
BANDA-ALT-BA-AA	9510	2001	
BANDA-ALT	2/9500PB	BANDA-VENT- OPCIONAL	9470
TERMOSTATO-190°	33599	BANDA-VENT	3/9470PB
BANDA-	9545	MANGUERA INFERIOR-TUBO A RAD.	CHARTER 2 1/2"
BANDA-	9590	MANGUERA SUPERIOR-TUBO A RAD.	CHARTER 2 1/2"
MANGUERA DE AGUA-	30T 5/8"	BANDA-TOMA DE FUERZA-ALT-AA	K080580
MANGUERA DE PASO-	CHARTER 1 3/4"	POLEA DEL TENSOR-TOMA DE FUERZA-ALT-AA	38075
MANGUERA SILICÓN-	SIH250363C	SENSOR-TOMA DE FUERZA-ALT-AA	38501
1992		MANGUERA INFERIOR-MOTOR A TUBO	CHARTER 2 1/2"
BANDA-VENT- OPCIONAL	9490	MANGUERA SUPERIOR-MOTOR A TUBO	CHARTER 2 1/2"
BANDA-VENT	2/9490PB	TERMOSTATO-190°	33599
BANDA-ALT-BA-AA	2/9510PB	2000	
BANDA-ALT-BA-AA	9510	BANDA-VENT- OPCIONAL	9470
BANDA-ALT	2/9500PB	BANDA-VENT	3/9470PB
TERMOSTATO-190°	33599	MANGUERA SILICÓN-TUBO A RAD.	SIH250363C
BANDA-	9545	BANDA-TOMA DE FUERZA-ALT-AA	K080580
BANDA-	9590	POLEA DEL TENSOR-TOMA DE FUERZA-ALT-AA	38075
MANGUERA DE AGUA-	30T 5/8"	SENSOR-TOMA DE FUERZA-ALT-AA	38501
MANGUERA DE PASO-	CHARTER 1 3/4"	MANGUERA SILICÓN-MOTOR A TUBO	SIH250363C
MANGUERA SILICÓN-	SIH250363C	TERMOSTATO-190°	33599
1991		1999	
BANDA-VENT- OPCIONAL	9490	BANDA-VENT- OPCIONAL	9470
BANDA-VENT	2/9490PB	BANDA-VENT	3/9470PB
BANDA-ALT-BA-AA	2/9510PB	MANGUERA SILICÓN-TUBO A RAD.	SIH300363C
BANDA-ALT-BA-AA	9510	MANGUERA SILICÓN-MOTOR A TUBO	SIH250363C
BANDA-ALT	2/9500PB	BANDA-ALT-AA	2/9520PB
TERMOSTATO-190°	33599	BANDA-ALT-AA	9520



MASTER SERVICIO PESADO 2014

KENWORTH

W900

TERMOSTATO-190°	33599	BANDA-ALT-AA	2/9520PB
MANGUERA DE AGUA-	30T 3/4"	BANDA-ALT-AA	9520
MANGUERA DE AGUA-	30T 5/8"	TERMOSTATO-190°	33599
MANGUERA SILICÓN-	SIH250363C	MANGUERA DE AGUA-	30T 3/4"
1998		MANGUERA DE AGUA-	30T 5/8"
BANDA-VENT- OPCIONAL	9470	MANGUERA SILICÓN-	SIH250363C
BANDA-VENT	3/9470PB	1994	
MANGUERA SILICÓN-TUBO A RAD.	SIH300363C	BANDA-VENT- OPCIONAL	9470
MANGUERA SILICÓN-MOTOR A TUBO	SIH250363C	BANDA-VENT	3/9470PB
BANDA-ALT-AA	2/9520PB	MANGUERA SILICÓN-TUBO A RAD.	SIH300363C
BANDA-ALT-AA	9520	MANGUERA SILICÓN-MOTOR A TUBO	SIH250363C
TERMOSTATO-190°	33599	BANDA-ALT-AA	2/9520PB
MANGUERA DE AGUA-	30T 3/4"	BANDA-ALT-AA	9520
MANGUERA DE AGUA-	30T 5/8"	TERMOSTATO-190°	33599
MANGUERA SILICÓN-	SIH250363C	MANGUERA DE AGUA-	30T 3/4"
1997		MANGUERA DE AGUA-	30T 5/8"
BANDA-VENT- OPCIONAL	9470	MANGUERA SILICÓN-	SIH250363C
BANDA-VENT	3/9470PB	1993	
MANGUERA SILICÓN-TUBO A RAD.	SIH300363C	BANDA-VENT- OPCIONAL	9490
MANGUERA SILICÓN-MOTOR A TUBO	SIH250363C	BANDA-VENT	2/9490PB
BANDA-ALT-AA	2/9520PB	BANDA-ALT-BA-AA	2/9510PB
BANDA-ALT-AA	9520	BANDA-ALT-BA-AA	9510
TERMOSTATO-190°	33599	BANDA-ALT	2/9500PB
MANGUERA DE AGUA-	30T 3/4"	TERMOSTATO-190°	33599
MANGUERA DE AGUA-	30T 5/8"	BANDA-	9545
MANGUERA SILICÓN-	SIH250363C	BANDA-	9590
1996		MANGUERA DE AGUA-	30T 5/8"
BANDA-VENT- OPCIONAL	9470	MANGUERA DE PASO-	CHARTER 1 3/4"
BANDA-VENT	3/9470PB	MANGUERA SILICÓN-	SIH250363C
MANGUERA SILICÓN-TUBO A RAD.	SIH300363C	1992	
MANGUERA SILICÓN-MOTOR A TUBO	SIH250363C	BANDA-VENT- OPCIONAL	9490
BANDA-ALT-AA	2/9520PB	BANDA-VENT	2/9490PB
BANDA-ALT-AA	9520	BANDA-ALT-BA-AA	2/9510PB
BANDA-ALT	2/9325PB	BANDA-ALT-BA-AA	9510
TERMOSTATO-190°	33599	BANDA-ALT	2/9500PB
MANGUERA DE AGUA-	30T 3/4"	TERMOSTATO-190°	33599
MANGUERA DE AGUA-	30T 5/8"	BANDA-	9545
MANGUERA SILICÓN-	SIH250363C	BANDA-	9590
1995		MANGUERA DE AGUA-	30T 5/8"
BANDA-VENT- OPCIONAL	9470	MANGUERA DE PASO-	CHARTER 1 3/4"
BANDA-VENT	3/9470PB	MANGUERA SILICÓN-	SIH250363C
MANGUERA SILICÓN-TUBO A RAD.	SIH300363C	1991	
MANGUERA SILICÓN-MOTOR A TUBO	SIH250363C	BANDA-VENT- OPCIONAL	9490



BANDA-VENT	2/9490PB	BANDA-ALT	PQ17470
BANDA-ALT-BA-AA	2/9510PB	BANDA-AA	PQ17400
BANDA-ALT-BA-AA	9510	BANDA-AA	PQ28429
BANDA-ALT	2/9500PB	CUMMINS N14 DIESEL	
TERMOSTATO-190°	33599	2006	
BANDA-	9545	TERMOSTATO-190°	33579
BANDA-	9590	TERMOSTATO-180°	33576
MANGUERA DE AGUA-	30T 5/8"	TERMOSTATO-180°	33578
MANGUERA DE PASO-	CHARTER 1 3/4"	TERMOSTATO-170°	33577
MANGUERA SILICÓN-	SIH250363C	2005	
CUMMINS SIGNATURE 600 DIESEL		TERMOSTATO-190°	33579
2002		TERMOSTATO-180°	33576
BANDA-VENT	K100670	TERMOSTATO-180°	33578
POLEA DEL TENSOR-VENT	36092	TERMOSTATO-170°	33577
TENSOR-VENT	38535	2004	
MANGUERA SILICÓN-TUBO A RAD.	SIH250363C	TERMOSTATO-190°	33579
POLEA DEL TENSOR-TOMA DE FUERZA-ALT-AA	36095	TERMOSTATO-180°	33576
TENSOR-TOMA DE FUERZA-ALT-AA	38532	TERMOSTATO-180°	33578
MANGUERA SILICÓN-MOTOR A TUBO	SIH250363C	TERMOSTATO-170°	33577
BANDA-ALT-BA-AA	K060685	2003	
2001		MANGUERA SILICÓN-TUBO A RAD.	SIH250363C
BANDA-VENT	K100670	MANGUERA SUPERIOR-TUBO A RAD.	CHARTER 2 1/2"
POLEA DEL TENSOR-VENT	36092	BANDA-TOMA DE FUERZA-VENT	PQ28473
TENSOR-VENT	38535	BANDA-TOMA DE FUERZA-VENT	TR28473
MANGUERA SILICÓN-TUBO A RAD.	SIH250363C	BANDA-TOMA DE FUERZA-BA	K060425
POLEA DEL TENSOR-TOMA DE FUERZA-ALT-AA	36095	BANDA-TOMA DE FUERZA-AA	9425
TENSOR-TOMA DE FUERZA-ALT-AA	38532	BANDA-TOMA DE FUERZA-AA	PQ17420
MANGUERA SILICÓN-MOTOR A TUBO	SIH250363C	MANGUERA SILICÓN-MOTOR A TUBO	SIH250363C
BANDA-ALT-BA-AA	K060685	MANGUERA SUPERIOR-MOTOR A TUBO	CHARTER 2 1/2"
2000		BANDA-ALT	9451
BANDA-VENT	K100670	BANDA-ALT	PQ17450
POLEA DEL TENSOR-VENT	36092	TERMOSTATO-190°	33579
TENSOR-VENT	38535	TERMOSTATO-180°	33576
MANGUERA SILICÓN-TUBO A RAD.	SIH250363C	TERMOSTATO-180°	33578
POLEA DEL TENSOR-TOMA DE FUERZA-ALT-AA	36095	TERMOSTATO-170°	33577
TENSOR-TOMA DE FUERZA-ALT-AA	38532	MANGUERA INFERIOR-	CHARTER 2 1/2"
MANGUERA SILICÓN-MOTOR A TUBO	SIH250363C	2002	
BANDA-ALT-BA-AA	K060685	MANGUERA SILICÓN-TUBO A RAD.	SIH250363C
CUMMINS NTC 300		MANGUERA SUPERIOR-TUBO A RAD.	CHARTER 2 1/2"
1990		BANDA-TOMA DE FUERZA-VENT	TR28483
BANDA-VENT	PQ28492	BANDA-TOMA DE FUERZA-BA	K060425
BANDA-BA	K040425	BANDA-TOMA DE FUERZA-AA	9425
BANDA-ALT	PQ17400	BANDA-TOMA DE FUERZA-AA	PQ17420



MASTER SERVICIO PESADO 2014

KENWORTH

W900

MANGUERA SILICÓN-MOTOR A TUBO	SIH250363C	MANGUERA INFERIOR-	CHARTER 2 1/2"
MANGUERA SUPERIOR-MOTOR A TUBO	CHARTER 2 1/2"	1999	
BANDA-ALT	9451	MANGUERA SILICÓN-TUBO A RAD.	SIH250363C
BANDA-ALT	PQ17450	MANGUERA SUPERIOR-TUBO A RAD.	CHARTER 2 1/2"
TERMOSTATO-190°	33579	BANDA-TOMA DE FUERZA-VENT	PQ28483
TERMOSTATO-180°	33576	BANDA-TOMA DE FUERZA-VENT	TR28483
TERMOSTATO-180°	33578	BANDA-TOMA DE FUERZA-BA	K060425
TERMOSTATO-170°	33577	BANDA-TOMA DE FUERZA-AA	9425
MANGUERA INFERIOR-	CHARTER 2 1/2"	BANDA-TOMA DE FUERZA-AA	PQ17430
2001		MANGUERA SILICÓN-MOTOR A TUBO	SIH250363C
MANGUERA SILICÓN-TUBO A RAD.	SIH250363C	MANGUERA SUPERIOR-MOTOR A TUBO	CHARTER 2 1/2"
MANGUERA SUPERIOR-TUBO A RAD.	CHARTER 2 1/2"	BANDA-ALT	9451
BANDA-TOMA DE FUERZA-VENT	PQ28483	BANDA-ALT	PQ17450
BANDA-TOMA DE FUERZA-VENT	TR28483	TERMOSTATO-190°	33579
BANDA-TOMA DE FUERZA-BA	K060425	TERMOSTATO-180°	33576
BANDA-TOMA DE FUERZA-AA	9425	TERMOSTATO-180°	33578
BANDA-TOMA DE FUERZA-AA	PQ17430	TERMOSTATO-170°	33577
MANGUERA SILICÓN-MOTOR A TUBO	SIH250363C	MANGUERA INFERIOR-	CHARTER 2 1/2"
MANGUERA SUPERIOR-MOTOR A TUBO	CHARTER 2 1/2"	1998	
BANDA-ALT	9451	MANGUERA SILICÓN-TUBO A RAD.	SIH250363C
BANDA-ALT	PQ17450	MANGUERA SUPERIOR-TUBO A RAD.	CHARTER 2 1/2"
TERMOSTATO-190°	33579	BANDA-TOMA DE FUERZA-VENT	PQ28483
TERMOSTATO-180°	33576	BANDA-TOMA DE FUERZA-VENT	TR28483
TERMOSTATO-180°	33578	BANDA-TOMA DE FUERZA-BA	K060425
TERMOSTATO-170°	33577	BANDA-TOMA DE FUERZA-AA	9425
MANGUERA INFERIOR-	CHARTER 2 1/2"	BANDA-TOMA DE FUERZA-AA	PQ17430
2000		MANGUERA SILICÓN-MOTOR A TUBO	SIH250363C
MANGUERA SILICÓN-TUBO A RAD.	SIH250363C	MANGUERA SUPERIOR-MOTOR A TUBO	CHARTER 2 1/2"
MANGUERA SUPERIOR-TUBO A RAD.	CHARTER 2 1/2"	BANDA-ALT	9451
BANDA-TOMA DE FUERZA-VENT	PQ28483	BANDA-ALT	PQ17450
BANDA-TOMA DE FUERZA-VENT	TR28483	TERMOSTATO-190°	33579
BANDA-TOMA DE FUERZA-BA	K060425	TERMOSTATO-180°	33576
BANDA-TOMA DE FUERZA-AA	9425	TERMOSTATO-180°	33578
BANDA-TOMA DE FUERZA-AA	PQ17430	TERMOSTATO-170°	33577
MANGUERA SILICÓN-MOTOR A TUBO	SIH250363C	MANGUERA INFERIOR-	CHARTER 2 1/2"
MANGUERA SUPERIOR-MOTOR A TUBO	CHARTER 2 1/2"	1997	
BANDA-ALT	9451	MANGUERA SILICÓN-TUBO A RAD.	SIH250363C
BANDA-ALT	PQ17450	MANGUERA SUPERIOR-TUBO A RAD.	CHARTER 2 1/2"
TERMOSTATO-190°	33579	BANDA-TOMA DE FUERZA-VENT	PQ28483
TERMOSTATO-180°	33576	BANDA-TOMA DE FUERZA-VENT	TR28483
TERMOSTATO-180°	33578	BANDA-TOMA DE FUERZA-BA	K060425
TERMOSTATO-170°	33577	BANDA-TOMA DE FUERZA-AA	9425
		BANDA-TOMA DE FUERZA-AA	PQ17430



MASTER SERVICIO PESADO 2014

KENWORTH

W900

MANGUERA SILICÓN-MOTOR A TUBO	SIH250363C	BANDA-ALT	9463
MANGUERA SUPERIOR-MOTOR A TUBO	CHARTER 2 1/2"	BANDA-ALT	9470
BANDA-ALT	9463	BANDA-ALT	PQ17460
BANDA-ALT	PQ17460	BANDA-ALT	PQ17470
TERMOSTATO-190°	33579	BANDA-AA	PQ17430
TERMOSTATO-180°	33576	TERMOSTATO-190°	33579
TERMOSTATO-180°	33578	TERMOSTATO-180°	33576
TERMOSTATO-170°	33577	TERMOSTATO-180°	33578
MANGUERA INFERIOR-	CHARTER 2 1/2"	TERMOSTATO-170°	33577
1996		BANDA-	9425
BANDA-VENT- OPCIONAL	TR28480	MANGUERA INFERIOR-	CHARTER 2 1/2"
BANDA-VENT- OPCIONAL	TR28492	MANGUERA SILICÓN-	SIH250363C
BANDA-VENT	2/TR28480PB	MANGUERA SUPERIOR-	CHARTER 2 1/2"
BANDA-VENT	2/TR28492PB	1994	
BANDA-VENT	PQ28480	BANDA-VENT- OPCIONAL	TR28480
BANDA-VENT	PQ28492	BANDA-VENT- OPCIONAL	TR28492
BANDA-BA	K060425	BANDA-VENT	2/TR28480PB
BANDA-ALT	2/9463PB	BANDA-VENT	2/TR28492PB
BANDA-ALT	2/9470PB	BANDA-VENT	PQ28480
BANDA-ALT	9463	BANDA-VENT	PQ28492
BANDA-ALT	9470	BANDA-BA	K060425
BANDA-ALT	PQ17460	BANDA-ALT	9463
BANDA-ALT	PQ17470	BANDA-ALT	9470
BANDA-AA	PQ17430	BANDA-ALT	PQ17460
TERMOSTATO-190°	33579	BANDA-ALT	PQ17470
TERMOSTATO-180°	33576	BANDA-AA	PQ17430
TERMOSTATO-180°	33578	TERMOSTATO-190°	33579
TERMOSTATO-170°	33577	TERMOSTATO-180°	33576
BANDA-	9425	TERMOSTATO-180°	33578
MANGUERA INFERIOR-	CHARTER 2 1/2"	TERMOSTATO-170°	33577
MANGUERA SILICÓN-	SIH250363C	BANDA-	9425
MANGUERA SUPERIOR-	CHARTER 2 1/2"	MANGUERA INFERIOR-	CHARTER 2 1/2"
1995		MANGUERA SILICÓN-	SIH250363C
BANDA-VENT- OPCIONAL	TR28480	MANGUERA SUPERIOR-	CHARTER 2 1/2"
BANDA-VENT- OPCIONAL	TR28492	1993	
BANDA-VENT	2/TR28480PB	BANDA-VENT- OPCIONAL	TR28480
BANDA-VENT	2/TR28492PB	BANDA-VENT- OPCIONAL	TR28492
BANDA-VENT	PQ28480	BANDA-VENT	2/TR28480PB
BANDA-VENT	PQ28492	BANDA-VENT	2/TR28492PB
BANDA-BA	K060425	BANDA-VENT	PQ28480
BANDA-ALT	2/9463PB	BANDA-VENT	PQ28492
BANDA-ALT	2/9470PB	MANGUERA SILICÓN-TUBO A RAD.	SIH300363C



MASTER SERVICIO PESADO 2014

KENWORTH

W900

MANGUERA SUPERIOR-TUBO A RAD.	CHARTER 3"	TERMOSTATO-180°	33578
MANGUERA SILICÓN-MOTOR A TUBO	SIH250363C	TERMOSTATO-170°	33577
MANGUERA SUPERIOR-MOTOR A TUBO	24436	1997	
MANGUERA SUPERIOR-MOTOR A TUBO	CHARTER 2 1/4"	TERMOSTATO-190°	33579
BANDA-BA	K060425	TERMOSTATO-180°	33576
BANDA-ALT	9463	TERMOSTATO-180°	33578
BANDA-ALT	9470	TERMOSTATO-170°	33577
BANDA-ALT	PQ17460	1996	
BANDA-ALT	PQ17470	TERMOSTATO-190°	33579
BANDA-AA	PQ17430	TERMOSTATO-180°	33576
TERMOSTATO-190°	33579	TERMOSTATO-180°	33578
TERMOSTATO-180°	33576	TERMOSTATO-170°	33577
TERMOSTATO-180°	33578	1995	
TERMOSTATO-170°	33577	TERMOSTATO-190°	33579
BANDA-	9425	TERMOSTATO-180°	33576
MANGUERA DE AGUA-	30T 5/8"	TERMOSTATO-180°	33578
MANGUERA DE CALEFACCIÓN-	35B 5/8"	TERMOSTATO-170°	33577
MANGUERA DE PASO-	CHARTER 1 1/2"	1994	
MANGUERA INFERIOR-	CHARTER 1 1/4"	TERMOSTATO-190°	33579
MANGUERA INFERIOR-	CHARTER 2 1/2"	TERMOSTATO-180°	33576
MANGUERA INFERIOR-	CHARTER 3"	TERMOSTATO-180°	33578
MANGUERA SILICÓN-	SIH250363C	TERMOSTATO-170°	33577
MANGUERA SUPERIOR-	CHARTER 2 1/2"	CUMMINS L10 DIESEL	
1992		1992	
MANGUERA SILICÓN-TUBO A RAD.	SIH300363C	TERMOSTATO-190°	33579
MANGUERA SUPERIOR-TUBO A RAD.	CHARTER 3"	TERMOSTATO-180°	33576
MANGUERA SILICÓN-MOTOR A TUBO	SIH250363C	TERMOSTATO-180°	33578
MANGUERA SUPERIOR-MOTOR A TUBO	24436	TERMOSTATO-175°	33960
MANGUERA SUPERIOR-MOTOR A TUBO	CHARTER 2 1/4"	TERMOSTATO-170°	33577
TERMOSTATO-190°	33579	1991	
TERMOSTATO-180°	33576	TERMOSTATO-190°	33579
TERMOSTATO-180°	33578	TERMOSTATO-180°	33576
TERMOSTATO-170°	33577	TERMOSTATO-180°	33578
MANGUERA DE AGUA-	30T 5/8"	TERMOSTATO-175°	33960
MANGUERA DE CALEFACCIÓN-	35B 5/8"	TERMOSTATO-170°	33577
MANGUERA DE PASO-	CHARTER 1 1/2"	CUMMINS ISX DIESEL	
MANGUERA INFERIOR-	CHARTER 1 1/4"	2013	
MANGUERA INFERIOR-	CHARTER 2 1/2"	MANGUERA INFERIOR-TUBO A RAD.	21135
MANGUERA INFERIOR-	CHARTER 3"	MANGUERA SILICÓN-MOTOR A	SIH250363C
CUMMINS M11 DIESEL		MANGUERA SILICÓN-CODO A 90°	SIH250124C90
1998		BANDA-BA-AA	K060637
TERMOSTATO-190°	33579	TENSOR-BA-AA	38610
TERMOSTATO-180°	33576	BANDA-ALT-BA-VENT	K120911



MASTER SERVICIO PESADO 2014

KENWORTH

W900

TENSOR-ALT-BA-VENT	38587	TERMOSTATO-180°	34148
POLEA-AA	36223	TAPÓN DE RADIADOR-(15 LBS) SIN PALANCA	31350
TERMOSTATO-190°	34149	2007	
TERMOSTATO-180°	34146	MANGUERA SILICÓN-TUBO A RAD.	SIH250363C
TERMOSTATO-180°	34148	BANDA-TOMA DE FUERZA-ALT-AA	K060637
TAPÓN DE RADIADOR-(15 LBS) SIN PALANCA	31350	MANGUERA SILICÓN-MOTOR A TUBO	SIH250363C
2012		BANDA-ALT-VENT	K120878
MANGUERA INFERIOR-TUBO A RAD.	21135	TENSOR-ALT-VENT	38587
MANGUERA SILICÓN-MOTOR A	SIH250363C	2006	
MANGUERA SILICÓN-CODO A 90°	SIH250124C90	MANGUERA SILICÓN-TUBO A RAD.	SIH250363C
BANDA-BA-AA	K060637	BANDA-TOMA DE FUERZA-ALT-AA	K060637
TENSOR-BA-AA	38610	MANGUERA SILICÓN-MOTOR A TUBO	SIH250363C
BANDA-ALT-BA-VENT	K120911	BANDA-ALT-VENT	K120878
TENSOR-ALT-BA-VENT	38587	TENSOR-ALT-VENT	38587
POLEA-AA	36223	2005	
TERMOSTATO-190°	34149	MANGUERA SILICÓN-TUBO A RAD.	SIH250363C
TERMOSTATO-180°	34146	BANDA-TOMA DE FUERZA-ALT-AA	K060637
TERMOSTATO-180°	34148	MANGUERA SILICÓN-MOTOR A TUBO	SIH250363C
TAPÓN DE RADIADOR-(15 LBS) SIN PALANCA	31350	BANDA-ALT-VENT	K120878
2011		TENSOR-ALT-VENT	38587
MANGUERA INFERIOR-TUBO A RAD.	21135	2004	
MANGUERA SILICÓN-MOTOR A	SIH250363C	MANGUERA SILICÓN-TUBO A RAD.	SIH250363C
MANGUERA SILICÓN-CODO A 90°	SIH250124C90	BANDA-TOMA DE FUERZA-ALT-AA	K060637
BANDA-BA-AA	K060637	MANGUERA SILICÓN-MOTOR A TUBO	SIH250363C
TENSOR-BA-AA	38610	BANDA-ALT-VENT	K120878
BANDA-ALT-BA-VENT	K120911	TENSOR-ALT-VENT	38587
TENSOR-ALT-BA-VENT	38587	2003	
POLEA-AA	36223	BANDA-VENT	K100670
TERMOSTATO-190°	34149	POLEA DEL TENSOR-VENT	36092
TERMOSTATO-180°	34146	TENSOR-VENT	38535
TERMOSTATO-180°	34148	MANGUERA SILICÓN-TUBO A RAD.	SIH250363C
TAPÓN DE RADIADOR-(15 LBS) SIN PALANCA	31350	BANDA-TOMA DE FUERZA-ALT-AA-C/PURIF DE AIRE	K060637
2010		BANDA-TOMA DE FUERZA-ALT-AA	K060685
MANGUERA INFERIOR-TUBO A RAD.	21135	POLEA DEL TENSOR-TOMA DE FUERZA-ALT-AA	36095
MANGUERA SILICÓN-MOTOR A	SIH250363C	TENSOR-TOMA DE FUERZA-ALT-AA	38532
MANGUERA SILICÓN-CODO A 90°	SIH250124C90	MANGUERA SILICÓN-MOTOR A TUBO	SIH250363C
BANDA-BA-AA	K060637	BANDA-ALT-VENT-C/PURIF DE AIRE	K120931
TENSOR-BA-AA	38610	TENSOR-ALT-VENT	38587
BANDA-ALT-BA-VENT	K120911	2002	
TENSOR-ALT-BA-VENT	38587	BANDA-VENT	K100670
POLEA-AA	36223	POLEA DEL TENSOR-VENT	36092
TERMOSTATO-190°	34149	TENSOR-VENT	38535
TERMOSTATO-180°	34146	MANGUERA SILICÓN-TUBO A RAD.	SIH250363C



MASTER SERVICIO PESADO 2014

KENWORTH

W900

POLEA DEL TENSOR-TOMA DE FUERZA-ALT-AA	36095	TENSOR-TOMA DE FUERZA-AA	38505
TENSOR-TOMA DE FUERZA-ALT-AA	38532	MANGUERA SILICÓN-RAD. A TUBO	SIH250363C
MANGUERA SILICÓN-MOTOR A TUBO	SIH250363C	MANGUERA SILICÓN-RAD. A TUBO	SIH300363C
BANDA-ALT-BA-AA	K060685	MANGUERA SILICÓN-MOTOR A TUBO	SIH250363C
2001		BANDA-ALT-VENT	K080702
BANDA-VENT	K100670	TENSOR-ALT-VENT	38622
POLEA DEL TENSOR-VENT	36092	POLEA DEL TENSOR-	36091
TENSOR-VENT	38535	2004	
MANGUERA SILICÓN-TUBO A RAD.	SIH250363C	BANDA-TOMA DE FUERZA-AA	K060539
POLEA DEL TENSOR-TOMA DE FUERZA-ALT-AA	36095	TENSOR-TOMA DE FUERZA-AA	38505
TENSOR-TOMA DE FUERZA-ALT-AA	38532	MANGUERA SILICÓN-RAD. A TUBO	SIH250363C
MANGUERA SILICÓN-MOTOR A TUBO	SIH250363C	MANGUERA SILICÓN-RAD. A TUBO	SIH300363C
BANDA-ALT-BA-AA	K060685	MANGUERA SILICÓN-MOTOR A TUBO	SIH250363C
2000		BANDA-ALT-VENT	K080702
BANDA-VENT	K100670	TENSOR-ALT-VENT	38521
POLEA DEL TENSOR-VENT	36092	POLEA DEL TENSOR-	36091
TENSOR-VENT	38535	2003	
MANGUERA SILICÓN-TUBO A RAD.	SIH250363C	BANDA-TOMA DE FUERZA-AA	K060539
POLEA DEL TENSOR-TOMA DE FUERZA-ALT-AA	36095	TENSOR-TOMA DE FUERZA-AA	38505
TENSOR-TOMA DE FUERZA-ALT-AA	38532	MANGUERA SILICÓN-RAD. A TUBO	SIH250363C
MANGUERA SILICÓN-MOTOR A TUBO	SIH250363C	MANGUERA SILICÓN-RAD. A TUBO	SIH300363C
BANDA-ALT-BA-AA	K060685	MANGUERA SILICÓN-MOTOR A TUBO	SIH250363C
1999		BANDA-ALT-VENT	K080702
BANDA-VENT	K100670	TENSOR-ALT-VENT	38521
POLEA DEL TENSOR-VENT	36092	POLEA DEL TENSOR-	36091
TENSOR-VENT	38535	2002	
MANGUERA SILICÓN-TUBO A RAD.	SIH250363C	BANDA-TOMA DE FUERZA-AA	9530
POLEA DEL TENSOR-TOMA DE FUERZA-ALT-AA	36095	BANDA-ALT-VENT	K080708
TENSOR-TOMA DE FUERZA-ALT-AA	38532	TENSOR-ALT-VENT	38521
MANGUERA SILICÓN-MOTOR A TUBO	SIH250363C	1999	
BANDA-ALT-BA-AA	K060685	BANDA-	K080485
CUMMINS ISM DIESEL		CUMMINS ISC DIESEL	
2006		2004	
MANGUERA SILICÓN-TUBO A RAD.	SIH300363C	BANDA-ALT-VENT	K080716
BANDA-TOMA DE FUERZA-AA-C/CUBIERTA CORTA	K060539	POLEA-ALT-VENT	36093
TENSOR-TOMA DE FUERZA-AA	38505	TENSOR-ALT-VENT	38516
MANGUERA SILICÓN-RAD. A TUBO	SIH250363C	TERMOSTATO-180°-C/DOBLE TERMOSTATO	33966
MANGUERA SILICÓN-MOTOR A TUBO	SIH250363C	TERMOSTATO-180°	33959
BANDA-ALT-VENT-C/CUBIERTA CORTA	K080702	BANDA-	9463
TENSOR-ALT-VENT	38622	2003	
POLEA DEL TENSOR-	36091	BANDA-ALT-VENT	K080716
2005		POLEA-ALT-VENT	36093
BANDA-TOMA DE FUERZA-AA	K060539	TENSOR-ALT-VENT	38516



TERMOSTATO-180°-C/DOBLE TERMOSTATO	33966	MANGUERA SILICÓN-MOTOR A TUBO	SIH300363C
TERMOSTATO-180°	33959	BANDA-ALT-VENT-AA	9610
BANDA-	9463	TERMOSTATO-190°	33579
CUMMINS 6 CIL, 14.0 L DIESEL		TERMOSTATO-180°	33576
1991		TERMOSTATO-180°	33578
MANGUERA SILICÓN-TUBO A RAD.	SIH300363C	TERMOSTATO-170°	33577
MANGUERA SILICÓN-MOTOR A TUBO	SIH250363C	2000	
MANGUERA SUPERIOR-MOTOR A TUBO	24436	BANDA-VENT- OPCIONAL	TR22570
TERMOSTATO-180°	33961	BANDA-VENT	2/TR22570PB
TERMOSTATO-180°	33962	MANGUERA SILICÓN-TUBO A RAD.	SIH250363C
MANGUERA DE AGUA-	30T 5/8"	MANGUERA SILICÓN-TUBO A RAD.	SIH300363C
MANGUERA DE PASO-	CHARTER 1 1/2"	MANGUERA SILICÓN-MOTOR A TUBO	SIH250363C
CATERPILLAR C16 DIESEL		MANGUERA SILICÓN-MOTOR A TUBO	SIH300363C
2003		BANDA-ALT-VENT-AA	9610
BANDA-VENT- OPCIONAL	TR22570	TERMOSTATO-190°	33579
BANDA-VENT	2/TR22570PB	TERMOSTATO-180°	33576
MANGUERA SILICÓN-TUBO A RAD.	SIH250363C	TERMOSTATO-180°	33578
MANGUERA SILICÓN-TUBO A RAD.	SIH300363C	TERMOSTATO-170°	33577
MANGUERA SILICÓN-MOTOR A TUBO	SIH250363C	CATERPILLAR C15 DIESEL	
MANGUERA SILICÓN-MOTOR A TUBO	SIH300363C	2010	
BANDA-ALT-VENT-AA	9610	BANDA-VENT-AA	38636
TERMOSTATO-190°	33579	BANDA-VENT-AA	K121049
TERMOSTATO-180°	33576	MANGUERA INFERIOR-RAD. A TUBO	21135
TERMOSTATO-180°	33578	MANGUERA SILICÓN-RAD. A TUBO	SIH250363C
TERMOSTATO-170°	33577	MANGUERA SILICÓN-MOTOR A TUBO	SIH250363C
2002		POLEA-MOTOR	36091
BANDA-VENT- OPCIONAL	TR22570	POLEA-MOTOR	36341
BANDA-VENT	2/TR22570PB	BANDA-ALT-VENT	38609
MANGUERA SILICÓN-TUBO A RAD.	SIH250363C	BANDA-ALT-VENT	K060690
MANGUERA SILICÓN-TUBO A RAD.	SIH300363C	TERMOSTATO-190°	33579
MANGUERA SILICÓN-MOTOR A TUBO	SIH250363C	TERMOSTATO-180°	33576
MANGUERA SILICÓN-MOTOR A TUBO	SIH300363C	TERMOSTATO-180°	33578
BANDA-ALT-VENT-AA	9610	TERMOSTATO-170°	33577
TERMOSTATO-190°	33579	TAPÓN DE RADIADOR-(15 LBS) SIN PALANCA	31350
TERMOSTATO-180°	33576	BOMBA DE AGUA-	44062HD
TERMOSTATO-180°	33578	2009	
TERMOSTATO-170°	33577	BANDA-VENT-AA	38636
2001		BANDA-VENT-AA	K121049
BANDA-VENT- OPCIONAL	TR22570	MANGUERA INFERIOR-RAD. A TUBO	21135
BANDA-VENT	2/TR22570PB	MANGUERA SILICÓN-RAD. A TUBO	SIH250363C
MANGUERA SILICÓN-TUBO A RAD.	SIH250363C	MANGUERA SILICÓN-MOTOR A TUBO	SIH250363C
MANGUERA SILICÓN-TUBO A RAD.	SIH300363C	POLEA-MOTOR	36091
MANGUERA SILICÓN-MOTOR A TUBO	SIH250363C	POLEA-MOTOR	36341



MASTER SERVICIO PESADO 2014

KENWORTH

W900

BANDA-ALT-VENT	38609	BANDA-VENT-AA	K060615
BANDA-ALT-VENT	K060690	POLEA DEL TENSOR-VENT-AA	36091
TERMOSTATO-190°	33579	TENSOR-VENT-AA	38511
TERMOSTATO-180°	33576	MANGUERA SILICÓN-TUBO A RAD.	SIH250363C
TERMOSTATO-180°	33578	MANGUERA SILICÓN-TUBO A RAD.	SIH300363C
TERMOSTATO-170°	33577	MANGUERA SILICÓN-MOTOR A TUBO	SIH250363C
TAPÓN DE RADIADOR-(15 LBS) SIN PALANCA	31350	MANGUERA SILICÓN-MOTOR A TUBO	SIH300363C
BOMBA DE AGUA-	44062HD	POLEA-MOTOR	36091
		POLEA-MOTOR	36093
2008			
BANDA-VENT-AA	38636	BANDA-ALT-VENT	K080952
BANDA-VENT-AA	K121049	TENSOR-ALT-VENT	38569
MANGUERA INFERIOR-RAD. A TUBO	21135	TERMOSTATO-190°	33579
MANGUERA SILICÓN-RAD. A TUBO	SIH250363C	TERMOSTATO-180°	33576
MANGUERA SILICÓN-MOTOR A TUBO	SIH250363C	TERMOSTATO-180°	33578
POLEA-MOTOR	36091	TERMOSTATO-170°	33577
POLEA-MOTOR	36341		
		2005	
BANDA-ALT-VENT	38609	BANDA-VENT-AA	K060615
BANDA-ALT-VENT	K060690	POLEA DEL TENSOR-VENT-AA	36091
TERMOSTATO-190°	33579	TENSOR-VENT-AA	38511
TERMOSTATO-180°	33576	MANGUERA SILICÓN-TUBO A RAD.	SIH250363C
TERMOSTATO-180°	33578	MANGUERA SILICÓN-TUBO A RAD.	SIH300363C
TERMOSTATO-170°	33577	MANGUERA SILICÓN-MOTOR A TUBO	SIH250363C
TAPÓN DE RADIADOR-(15 LBS) SIN PALANCA	31350	MANGUERA SILICÓN-MOTOR A TUBO	SIH300363C
BOMBA DE AGUA-	44062HD	POLEA-MOTOR	36091
		POLEA-MOTOR	36093
2007			
BANDA-VENT-AA	K060555	BANDA-ALT-VENT	K080952
BANDA-VENT-AA	K060615	TENSOR-ALT-VENT	38569
POLEA DEL TENSOR-VENT-AA	36091	TERMOSTATO-190°	33579
TENSOR-VENT-AA	38511	TERMOSTATO-180°	33576
MANGUERA SILICÓN-TUBO A RAD.	SIH250363C	TERMOSTATO-180°	33578
MANGUERA SILICÓN-TUBO A RAD.	SIH300363C	TERMOSTATO-170°	33577
MANGUERA SILICÓN-MOTOR A TUBO	SIH250363C		
MANGUERA SILICÓN-MOTOR A TUBO	SIH300363C	2004	
POLEA-MOTOR	36091	BANDA-VENT-AA-C/PURIF DE AIRE	K060615
POLEA-MOTOR	36093	BANDA-VENT-AA	9520
BANDA-ALT-VENT	K080952	POLEA DEL TENSOR-VENT-AA	36091
TENSOR-ALT-VENT	38569	TENSOR-VENT-AA	38511
TERMOSTATO-190°	33579	MANGUERA SILICÓN-TUBO A RAD.	SIH250363C
TERMOSTATO-180°	33576	MANGUERA SILICÓN-TUBO A RAD.	SIH300363C
TERMOSTATO-180°	33578	MANGUERA SILICÓN-MOTOR A TUBO	SIH250363C
TERMOSTATO-170°	33577	MANGUERA SILICÓN-MOTOR A TUBO	SIH300363C
		POLEA-MOTOR	36091
		POLEA-MOTOR	36093
2006			
BANDA-VENT-AA	K060555		



BANDA-ALT-VENT-C/PURIF DE AIRE	K080952	2000	
BANDA-ALT-VENT	TR22648	BANDA-VENT- OPCIONAL	TR22570
TENSOR-ALT-VENT	38569	BANDA-VENT	2/TR22570PB
TERMOSTATO-190°	33579	MANGUERA SILICÓN-TUBO A RAD.	SIH250363C
TERMOSTATO-180°	33576	MANGUERA SILICÓN-TUBO A RAD.	SIH300363C
TERMOSTATO-180°	33578	MANGUERA SILICÓN-MOTOR A TUBO	SIH250363C
TERMOSTATO-170°	33577	MANGUERA SILICÓN-MOTOR A TUBO	SIH300363C
2003		BANDA-ALT-VENT-AA	9610
BANDA-VENT- OPCIONAL	TR22570	TERMOSTATO-190°	33579
BANDA-VENT	2/TR22570PB	TERMOSTATO-180°	33576
MANGUERA SILICÓN-TUBO A RAD.	SIH250363C	TERMOSTATO-180°	33578
MANGUERA SILICÓN-TUBO A RAD.	SIH300363C	TERMOSTATO-170°	33577
MANGUERA SILICÓN-MOTOR A TUBO	SIH250363C	CATERPILLAR C13 DIESEL	
MANGUERA SILICÓN-MOTOR A TUBO	SIH300363C	2010	
BANDA-ALT-VENT-AA	9610	BANDA-VENT-AA	K100946
TERMOSTATO-190°	33579	MANGUERA SILICÓN-RAD. A TUBO	SIH250363C
TERMOSTATO-180°	33576	MANGUERA SILICÓN-RAD. A TUBO	SIH300363C
TERMOSTATO-180°	33578	MANGUERA SILICÓN-MOTOR A TUBO	SIH250363C
TERMOSTATO-170°	33577	MANGUERA SILICÓN-MOTOR A RAD.	SIH250363C
2002		BANDA-ALT	K060858
BANDA-VENT- OPCIONAL	TR22570	TENSOR-ALT	38635
BANDA-VENT	2/TR22570PB	TERMOSTATO-190°	33579
MANGUERA SILICÓN-TUBO A RAD.	SIH250363C	TERMOSTATO-180°	33576
MANGUERA SILICÓN-TUBO A RAD.	SIH300363C	TERMOSTATO-180°	33578
MANGUERA SILICÓN-MOTOR A TUBO	SIH250363C	TERMOSTATO-170°	33577
MANGUERA SILICÓN-MOTOR A TUBO	SIH300363C	TAPÓN DE RADIADOR-(15 LBS) SIN PALANCA	31350
BANDA-ALT-VENT-AA	9610	2009	
TERMOSTATO-190°	33579	BANDA-VENT-AA	K100946
TERMOSTATO-180°	33576	MANGUERA SILICÓN-RAD. A TUBO	SIH250363C
TERMOSTATO-180°	33578	MANGUERA SILICÓN-RAD. A TUBO	SIH300363C
TERMOSTATO-170°	33577	MANGUERA SILICÓN-MOTOR A TUBO	SIH250363C
2001		MANGUERA SILICÓN-MOTOR A RAD.	SIH250363C
BANDA-VENT- OPCIONAL	TR22570	BANDA-ALT	K060858
BANDA-VENT	2/TR22570PB	TENSOR-ALT	38635
MANGUERA SILICÓN-TUBO A RAD.	SIH250363C	TERMOSTATO-190°	33579
MANGUERA SILICÓN-TUBO A RAD.	SIH300363C	TERMOSTATO-180°	33576
MANGUERA SILICÓN-MOTOR A TUBO	SIH250363C	TERMOSTATO-180°	33578
MANGUERA SILICÓN-MOTOR A TUBO	SIH300363C	TERMOSTATO-170°	33577
BANDA-ALT-VENT-AA	9610	TAPÓN DE RADIADOR-(15 LBS) SIN PALANCA	31350
TERMOSTATO-190°	33579	2008	
TERMOSTATO-180°	33576	BANDA-VENT-AA	K100946
TERMOSTATO-180°	33578	MANGUERA SILICÓN-RAD. A TUBO	SIH250363C
TERMOSTATO-170°	33577	MANGUERA SILICÓN-RAD. A TUBO	SIH300363C



MASTER SERVICIO PESADO 2014

KENWORTH

W900

MANGUERA SILICÓN-MOTOR A TUBO	SIH250363C	MANGUERA SILICÓN-MOTOR A RAD.	SIH250363C
MANGUERA SILICÓN-MOTOR A RAD.	SIH250363C	POLEA-MOTOR	36341
BANDA-ALT	K060858	BANDA-ALT-VENT-AA	K080968
TENSOR-ALT	38635	TENSOR-ALT-VENT-AA	38590
TERMOSTATO-190°	33579	TERMOSTATO-190°	33579
TERMOSTATO-180°	33576	TERMOSTATO-180°	33576
TERMOSTATO-180°	33578	TERMOSTATO-180°	33578
TERMOSTATO-170°	33577	TERMOSTATO-170°	33577
TAPÓN DE RADIADOR-(15 LBS) SIN PALANCA	31350	TAPÓN DE RADIADOR-(15 LBS) SIN PALANCA	31350
2007		POLEA-	36269
MANGUERA SILICÓN-RAD. A TUBO	SIH250363C	POLEA DEL TENSOR-	36164
MANGUERA SILICÓN-RAD. A TUBO	SIH300363C	2004	
MANGUERA SILICÓN-MOTOR A TUBO	SIH250363C	MANGUERA SILICÓN-RAD. A TUBO	SIH250363C
MANGUERA SILICÓN-MOTOR A RAD.	SIH250363C	MANGUERA SILICÓN-RAD. A TUBO	SIH300363C
POLEA-MOTOR	36341	MANGUERA SILICÓN-MOTOR A TUBO	SIH250363C
BANDA-ALT-VENT-AA	K080968	MANGUERA SILICÓN-MOTOR A RAD.	SIH250363C
TENSOR-ALT-VENT-AA	38590	POLEA-MOTOR	36341
TERMOSTATO-190°	33579	BANDA-ALT-VENT-AA	K080968
TERMOSTATO-180°	33576	TENSOR-ALT-VENT-AA	38590
TERMOSTATO-180°	33578	TERMOSTATO-190°	33579
TERMOSTATO-170°	33577	TERMOSTATO-180°	33576
TAPÓN DE RADIADOR-(15 LBS) SIN PALANCA	31350	TERMOSTATO-180°	33578
POLEA-	36269	TERMOSTATO-170°	33577
POLEA DEL TENSOR-	36164	TAPÓN DE RADIADOR-(15 LBS) SIN PALANCA	31350
2006		POLEA-	36269
MANGUERA SILICÓN-RAD. A TUBO	SIH250363C	POLEA DEL TENSOR-	36164
MANGUERA SILICÓN-RAD. A TUBO	SIH300363C	CATERPILLAR C12 DIESEL	
MANGUERA SILICÓN-MOTOR A TUBO	SIH250363C	2006	
MANGUERA SILICÓN-MOTOR A RAD.	SIH250363C	TERMOSTATO-190°	33579
POLEA-MOTOR	36341	TERMOSTATO-180°	33576
BANDA-ALT-VENT-AA	K080968	TERMOSTATO-180°	33578
TENSOR-ALT-VENT-AA	38590	TERMOSTATO-170°	33577
TERMOSTATO-190°	33579	2005	
TERMOSTATO-180°	33576	TERMOSTATO-190°	33579
TERMOSTATO-180°	33578	TERMOSTATO-180°	33576
TERMOSTATO-170°	33577	TERMOSTATO-180°	33578
TAPÓN DE RADIADOR-(15 LBS) SIN PALANCA	31350	TERMOSTATO-170°	33577
POLEA-	36269	2004	
POLEA DEL TENSOR-	36164	POLEA-ALT-VENT	36091
2005		TERMOSTATO-190°	33579
MANGUERA SILICÓN-RAD. A TUBO	SIH250363C	TERMOSTATO-180°	33576
MANGUERA SILICÓN-RAD. A TUBO	SIH300363C	TERMOSTATO-180°	33578
MANGUERA SILICÓN-MOTOR A TUBO	SIH250363C	TERMOSTATO-170°	33577



2003		TERMOSTATO-180°	33578
POLEA-ALT-VENT	36091	TERMOSTATO-170°	33577
TERMOSTATO-190°	33579	1997	
TERMOSTATO-180°	33576	TERMOSTATO-190°	33579
TERMOSTATO-180°	33578	TERMOSTATO-180°	33576
TERMOSTATO-170°	33577	TERMOSTATO-180°	33578
		TERMOSTATO-170°	33577
2002		CATERPILLAR C11 DIESEL	
POLEA-ALT-VENT	36091	2007	
TERMOSTATO-190°	33579	MANGUERA SILICÓN-RAD. A TUBO	SIH250363C
TERMOSTATO-180°	33576	MANGUERA SILICÓN-RAD. A TUBO	SIH300363C
TERMOSTATO-180°	33578	MANGUERA SILICÓN-MOTOR A TUBO	SIH250363C
TERMOSTATO-170°	33577	MANGUERA SILICÓN-MOTOR A RAD.	SIH250363C
2001		POLEA-MOTOR	36093
BANDA-VENT-AA	9540	TENSOR-ALT-VENT-AA	38590
MANGUERA INFERIOR-TUBO A RAD.	CHARTER 2 1/2"	TERMOSTATO-190°	33579
MANGUERA SUPERIOR-TUBO A RAD.	CHARTER 2 1/2"	TERMOSTATO-180°	33576
MANGUERA INFERIOR-MOTOR A TUBO	CHARTER 2 1/2"	TERMOSTATO-180°	33578
MANGUERA SUPERIOR-MOTOR A TUBO	CHARTER 2 1/2"	TERMOSTATO-170°	33577
BANDA-ALT-VENT	K080810		
POLEA-ALT-VENT	36091	2006	
TERMOSTATO-190°	33579	MANGUERA SILICÓN-RAD. A TUBO	SIH250363C
TERMOSTATO-180°	33576	MANGUERA SILICÓN-RAD. A TUBO	SIH300363C
TERMOSTATO-180°	33578	MANGUERA SILICÓN-MOTOR A TUBO	SIH250363C
TERMOSTATO-170°	33577	MANGUERA SILICÓN-MOTOR A RAD.	SIH250363C
		POLEA-MOTOR	36093
2000		TENSOR-ALT-VENT-AA	38590
BANDA-VENT- OPCIONAL	TR22570	TERMOSTATO-190°	33579
BANDA-VENT	2/TR22570PB	TERMOSTATO-180°	33576
MANGUERA SILICÓN-TUBO A RAD.	SIH300363C	TERMOSTATO-180°	33578
MANGUERA SILICÓN-MOTOR A TUBO	SIH300363C	TERMOSTATO-170°	33577
BANDA-ALT-VENT-AA	9610		
POLEA-ALT-VENT	36091	2005	
TERMOSTATO-190°	33579	MANGUERA SILICÓN-RAD. A TUBO	SIH250363C
TERMOSTATO-180°	33576	MANGUERA SILICÓN-RAD. A TUBO	SIH300363C
TERMOSTATO-180°	33578	MANGUERA SILICÓN-MOTOR A TUBO	SIH250363C
TERMOSTATO-170°	33577	MANGUERA SILICÓN-MOTOR A RAD.	SIH250363C
		POLEA-MOTOR	36093
1999		TENSOR-ALT-VENT-AA	38590
TERMOSTATO-190°	33579	TERMOSTATO-190°	33579
TERMOSTATO-180°	33576	TERMOSTATO-180°	33576
TERMOSTATO-180°	33578	TERMOSTATO-180°	33578
TERMOSTATO-170°	33577	TERMOSTATO-170°	33577
1998		CATERPILLAR C10 DIESEL	
TERMOSTATO-190°	33579	2004	
TERMOSTATO-180°	33576		



MASTER SERVICIO PESADO 2014

KENWORTH

W900

BANDA-VENT-AA	9540	TERMOSTATO-190°	33579
MANGUERA INFERIOR-TUBO A RAD.	CHARTER 2 1/2"	TERMOSTATO-180°	33576
MANGUERA SUPERIOR-TUBO A RAD.	CHARTER 2 1/2"	TERMOSTATO-180°	33578
MANGUERA INFERIOR-MOTOR A TUBO	CHARTER 2 1/2"	TERMOSTATO-170°	33577
MANGUERA SUPERIOR-MOTOR A TUBO	CHARTER 2 1/2"	2000	
BANDA-ALT-VENT	K080810	BANDA-VENT- OPCIONAL	TR22570
POLEA-ALT-VENT	36091	BANDA-VENT	2/TR22570PB
TERMOSTATO-190°	33579	MANGUERA SILICÓN-TUBO A RAD.	SIH300363C
TERMOSTATO-180°	33576	MANGUERA SILICÓN-MOTOR A TUBO	SIH300363C
TERMOSTATO-180°	33578	BANDA-ALT-VENT-AA	9610
TERMOSTATO-170°	33577	POLEA-ALT-VENT	36091
2003		TERMOSTATO-190°	33579
BANDA-VENT-AA	9540	TERMOSTATO-180°	33576
MANGUERA INFERIOR-TUBO A RAD.	CHARTER 2 1/2"	TERMOSTATO-180°	33578
MANGUERA SUPERIOR-TUBO A RAD.	CHARTER 2 1/2"	TERMOSTATO-170°	33577
MANGUERA INFERIOR-MOTOR A TUBO	CHARTER 2 1/2"	1999	
MANGUERA SUPERIOR-MOTOR A TUBO	CHARTER 2 1/2"	BANDA-VENT- OPCIONAL	TR22570
BANDA-ALT-VENT	K080810	BANDA-VENT	2/TR22570PB
POLEA-ALT-VENT	36091	MANGUERA SILICÓN-TUBO A RAD.	SIH300363C
TERMOSTATO-190°	33579	MANGUERA SILICÓN-MOTOR A TUBO	SIH300363C
TERMOSTATO-180°	33576	BANDA-ALT-VENT-AA	9610
TERMOSTATO-180°	33578	POLEA-ALT-VENT	36091
TERMOSTATO-170°	33577	TERMOSTATO-190°	33579
2002		TERMOSTATO-180°	33576
BANDA-VENT-AA	9540	TERMOSTATO-180°	33578
MANGUERA INFERIOR-TUBO A RAD.	CHARTER 2 1/2"	TERMOSTATO-170°	33577
MANGUERA SUPERIOR-TUBO A RAD.	CHARTER 2 1/2"	1998	
MANGUERA INFERIOR-MOTOR A TUBO	CHARTER 2 1/2"	BANDA-VENT- OPCIONAL	TR22570
MANGUERA SUPERIOR-MOTOR A TUBO	CHARTER 2 1/2"	BANDA-VENT	2/TR22570PB
BANDA-ALT-VENT	K080810	MANGUERA SILICÓN-TUBO A RAD.	SIH300363C
POLEA-ALT-VENT	36091	MANGUERA SILICÓN-MOTOR A TUBO	SIH300363C
TERMOSTATO-190°	33579	BANDA-ALT-VENT-AA	9610
TERMOSTATO-180°	33576	POLEA-ALT-VENT	36091
TERMOSTATO-180°	33578	TERMOSTATO-190°	33579
TERMOSTATO-170°	33577	TERMOSTATO-180°	33576
2001		TERMOSTATO-180°	33578
BANDA-VENT-AA	9540	TERMOSTATO-170°	33577
MANGUERA INFERIOR-TUBO A RAD.	CHARTER 2 1/2"	1997	
MANGUERA SUPERIOR-TUBO A RAD.	CHARTER 2 1/2"	BANDA-VENT- OPCIONAL	TR22570
MANGUERA INFERIOR-MOTOR A TUBO	CHARTER 2 1/2"	BANDA-VENT	2/TR22570PB
MANGUERA SUPERIOR-MOTOR A TUBO	CHARTER 2 1/2"	MANGUERA SILICÓN-TUBO A RAD.	SIH300363C
BANDA-ALT-VENT	K080810	MANGUERA SILICÓN-MOTOR A TUBO	SIH300363C
POLEA-ALT-VENT	36091	BANDA-ALT-VENT-AA	9610



POLEA-ALT-VENT	36091	BANDA-ALT-AA	2/9590PB
TERMOSTATO-190°	33579	BANDA-ALT-AA	9590
TERMOSTATO-180°	33576	TERMOSTATO-190°	33579
TERMOSTATO-180°	33578	TERMOSTATO-180°	33576
TERMOSTATO-170°	33577	TERMOSTATO-180°	33578
CATERPILLAR 3406 DIESEL		TERMOSTATO-170°	33577
2001		MANGUERA DE AGUA-	30T 5/8"
TERMOSTATO-190°	33579	MANGUERA DE PASO-	CHARTER 1"
TERMOSTATO-180°	33576	MANGUERA SILICÓN-	SIH250363C
TERMOSTATO-180°	33578	MANGUERA SILICÓN-	SIH300363C
TERMOSTATO-170°	33577	1997	
2000		BANDA-VENT- OPCIONAL	TR22570
BANDA-VENT- OPCIONAL	TR22570	BANDA-VENT	2/TR22570PB
BANDA-VENT	2/TR22570PB	BANDA-ALT-AA	2/9590PB
MANGUERA SILICÓN-TUBO A RAD.	SIH250363C	BANDA-ALT-AA	9590
MANGUERA SILICÓN-TUBO A RAD.	SIH300363C	TERMOSTATO-190°	33579
MANGUERA SILICÓN-MOTOR A TUBO	SIH250363C	TERMOSTATO-180°	33576
MANGUERA SILICÓN-MOTOR A TUBO	SIH300363C	TERMOSTATO-180°	33578
BANDA-ALT-VENT-AA	9610	TERMOSTATO-170°	33577
TERMOSTATO-190°	33579	MANGUERA DE AGUA-	30T 5/8"
TERMOSTATO-180°	33576	MANGUERA DE PASO-	CHARTER 1"
TERMOSTATO-180°	33578	MANGUERA SILICÓN-	SIH250363C
TERMOSTATO-170°	33577	MANGUERA SILICÓN-	SIH300363C
1999		1996	
BANDA-VENT- OPCIONAL	TR22570	BANDA-VENT-C/VENT CLUTCH HORTON	TR22648
BANDA-VENT	2/TR22570PB	BANDA-VENT- OPCIONAL	TR22570
BANDA-VENT	TR22553	BANDA-VENT	2/TR22570PB
MANGUERA SILICÓN-TUBO A RAD.	SIH250363C	BANDA-VENT	TR22553
MANGUERA SILICÓN-TUBO A RAD.	SIH300363C	BANDA-VENT	TR22588
MANGUERA SILICÓN-MOTOR A TUBO	SIH250363C	BANDA-ALT-VENT	2/9555PB
MANGUERA SILICÓN-MOTOR A TUBO	SIH300363C	BANDA-ALT-VENT	9560
BANDA-ALT-VENT-AA	9610	BANDA-ALT-AA	2/9590PB
BANDA-ALT-AA	2/9590PB	BANDA-ALT-AA	2/9610PB
BANDA-ALT-AA	9590	BANDA-ALT-AA	2/9650PB
TERMOSTATO-190°	33579	BANDA-ALT-AA	9580
TERMOSTATO-180°	33576	BANDA-ALT-AA	9590
TERMOSTATO-180°	33578	BANDA-ALT-AA	9605
TERMOSTATO-170°	33577	BANDA-ALT-AA	9610
MANGUERA DE AGUA-	30T 5/8"	BANDA-ALT-AA	9620
MANGUERA DE PASO-	CHARTER 1"	BANDA-ALT-AA	9650
1998		TERMOSTATO-190°	33579
BANDA-VENT- OPCIONAL	TR22570	TERMOSTATO-180°	33576
BANDA-VENT	2/TR22570PB		



MASTER SERVICIO PESADO 2014

KENWORTH

W900

TERMOSTATO-180°	33578	BANDA-ALT-VENT	9560
TERMOSTATO-170°	33577	BANDA-ALT-AA-C/VENT CLUTCH KYSOR	2/9555PB
MANGUERA DE AGUA-	30T 5/8"	BANDA-ALT-AA-C/VENT CLUTCH KYSOR	9555
MANGUERA DE PASO-	CHARTER 1"	BANDA-ALT-AA	2/9530PB
MANGUERA SILICÓN-	SIH250363C	BANDA-ALT-AA	2/9590PB
MANGUERA SILICÓN-	SIH300363C	BANDA-ALT-AA	2/9610PB
1995		BANDA-ALT-AA	2/9650PB
BANDA-VENT-C/VENT CLUTCH HORTON	TR22648	BANDA-ALT-AA	9530
BANDA-VENT- OPCIONAL	TR22570	BANDA-ALT-AA	9580
BANDA-VENT	2/TR22570PB	BANDA-ALT-AA	9590
BANDA-VENT	TR22553	BANDA-ALT-AA	9605
BANDA-VENT	TR22588	BANDA-ALT-AA	9610
BANDA-ALT-VENT	2/9555PB	BANDA-ALT-AA	9620
BANDA-ALT-VENT	9560	BANDA-ALT-AA	9650
BANDA-ALT-AA-C/VENT CLUTCH KYSOR	2/9555PB	TERMOSTATO-190°	33579
BANDA-ALT-AA-C/VENT CLUTCH KYSOR	9555	TERMOSTATO-180°	33576
BANDA-ALT-AA	2/9530PB	TERMOSTATO-180°	33578
BANDA-ALT-AA	2/9590PB	TERMOSTATO-170°	33577
BANDA-ALT-AA	2/9610PB	MANGUERA DE AGUA-	30T 5/8"
BANDA-ALT-AA	2/9650PB	MANGUERA DE PASO-	CHARTER 1"
BANDA-ALT-AA	9530	MANGUERA SILICÓN-	SIH250363C
BANDA-ALT-AA	9580	MANGUERA SILICÓN-	SIH300363C
BANDA-ALT-AA	9590	1993	
BANDA-ALT-AA	9605	BANDA-VENT-C/VENT CLUTCH HORTON	TR22648
BANDA-ALT-AA	9610	BANDA-VENT- OPCIONAL	TR22570
BANDA-ALT-AA	9620	BANDA-VENT	2/TR22570PB
BANDA-ALT-AA	9650	BANDA-VENT	TR22553
TERMOSTATO-190°	33579	BANDA-VENT	TR22588
TERMOSTATO-180°	33576	BANDA-ALT-VENT	2/9555PB
TERMOSTATO-180°	33578	BANDA-ALT-VENT	9560
TERMOSTATO-170°	33577	BANDA-ALT-AA-C/VENT CLUTCH KYSOR	2/9555PB
MANGUERA DE AGUA-	30T 5/8"	BANDA-ALT-AA-C/VENT CLUTCH KYSOR	9555
MANGUERA DE PASO-	CHARTER 1"	BANDA-ALT-AA	2/9530PB
MANGUERA SILICÓN-	SIH250363C	BANDA-ALT-AA	2/9590PB
MANGUERA SILICÓN-	SIH300363C	BANDA-ALT-AA	2/9610PB
1994		BANDA-ALT-AA	2/9650PB
BANDA-VENT-C/VENT CLUTCH HORTON	TR22648	BANDA-ALT-AA	9530
BANDA-VENT- OPCIONAL	TR22570	BANDA-ALT-AA	9580
BANDA-VENT	2/TR22570PB	BANDA-ALT-AA	9590
BANDA-VENT	TR22553	BANDA-ALT-AA	9605
BANDA-VENT	TR22588	BANDA-ALT-AA	9610
BANDA-ALT-VENT	2/9555PB	BANDA-ALT-AA	9620



MASTER SERVICIO PESADO 2014

KENWORTH

W900

BANDA-ALT-AA	9650	BANDA-VENT	TR22553
TERMOSTATO-190°	33579	BANDA-VENT	TR22588
TERMOSTATO-180°	33576	BANDA-ALT-VENT	2/9555PB
TERMOSTATO-180°	33578	BANDA-ALT-VENT	9560
TERMOSTATO-170°	33577	BANDA-ALT-AA-C/VENT CLUTCH KYSOR	2/9555PB
MANGUERA DE AGUA-	30T 5/8"	BANDA-ALT-AA-C/VENT CLUTCH KYSOR	9555
MANGUERA DE PASO-	CHARTER 1"	BANDA-ALT-AA	2/9530PB
MANGUERA SILICÓN-	SIH250363C	BANDA-ALT-AA	2/9590PB
MANGUERA SILICÓN-	SIH300363C	BANDA-ALT-AA	2/9610PB
1992		BANDA-ALT-AA	2/9650PB
BANDA-VENT-C/VENT CLUTCH HORTON	TR22648	BANDA-ALT-AA	9530
BANDA-VENT- OPCIONAL	TR22570	BANDA-ALT-AA	9580
BANDA-VENT	2/TR22570PB	BANDA-ALT-AA	9590
BANDA-VENT	TR22553	BANDA-ALT-AA	9605
BANDA-VENT	TR22588	BANDA-ALT-AA	9610
BANDA-ALT-VENT	2/9555PB	BANDA-ALT-AA	9620
BANDA-ALT-VENT	9560	BANDA-ALT-AA	9650
BANDA-ALT-AA-C/VENT CLUTCH KYSOR	2/9555PB	TERMOSTATO-190°	33579
BANDA-ALT-AA-C/VENT CLUTCH KYSOR	9555	TERMOSTATO-180°	33576
BANDA-ALT-AA	2/9530PB	TERMOSTATO-180°	33578
BANDA-ALT-AA	2/9590PB	TERMOSTATO-170°	33577
BANDA-ALT-AA	2/9610PB	MANGUERA DE AGUA-	30T 5/8"
BANDA-ALT-AA	2/9650PB	MANGUERA DE PASO-	CHARTER 1"
BANDA-ALT-AA	9530	MANGUERA SILICÓN-	SIH250363C
BANDA-ALT-AA	9580	MANGUERA SILICÓN-	SIH300363C
BANDA-ALT-AA	9590	1990	
BANDA-ALT-AA	9605	BANDA-VENT C/FAN CLUTCH HORTON	TR22648
BANDA-ALT-AA	9610	BANDA-VENT C/AA	9625
BANDA-ALT-AA	9620	BANDA-VENT	BX56
BANDA-ALT-AA	9650	BANDA-VENT	PQ24570
TERMOSTATO-190°	33579	BANDA-VENT	TR22553
TERMOSTATO-180°	33576	BANDA-VENT	TR22588
TERMOSTATO-180°	33578	BANDA-ALT-VENT	2/9555PB
TERMOSTATO-170°	33577	BANDA-ALT-VENT	9560
MANGUERA DE AGUA-	30T 5/8"	BANDA-ALT-AA C/FAN CLUTCH KYSOR	PQ17550
MANGUERA DE PASO-	CHARTER 1"	BANDA-ALT-AA	2/9530PB
MANGUERA SILICÓN-	SIH250363C	BANDA-ALT-AA	2/9590PB
MANGUERA SILICÓN-	SIH300363C	BANDA-ALT-AA	2/9610PB
1991		BANDA-ALT-AA	2/9650PB
BANDA-VENT-C/VENT CLUTCH HORTON	TR22648	BANDA-ALT-AA	8580 GS
BANDA-VENT- OPCIONAL	TR22570	BANDA-ALT-AA	8608 GS
BANDA-VENT	2/TR22570PB	BANDA-ALT-AA	9590



MASTER SERVICIO PESADO 2014

KENWORTH

W900

BANDA-ALT-AA	9610	BANDA-VENT	K100677
BANDA-ALT-AA	9620	POLEA DEL TENSOR-VENT	36092
BANDA-ALT-AA	9650	TENSOR-VENT	38523
BANDA-ALT-AA	PQ17530	TENSOR-TOMA DE FUERZA-ALT-VENT-AA	38589
BANDA-ALT C/FAN CLUTCH KRYSOR	2/9555PB	MANGUERA INFERIOR-RAD. A TUBO	21891
TERMOSTATO-175°	33549	MANGUERA SUPERIOR-RAD. A TUBO	24436
MANGUERA DE CALEFACCIÓN-	35B 5/8"	MANGUERA SILICÓN-MOTOR A TUBO	SIH200363C
MANGUERA DE PASO-	CHARTER 1"	BANDA-ALT-VENT	K060670
MANGUERA INFERIOR-	CHARTER 3"	2005	
MANGUERA SUPERIOR-	CHARTER 2 1/2"	BANDA-VENT	K100677

CATERPILLAR 3176 DIESEL

1995

TERMOSTATO-190°	33579	POLEA DEL TENSOR-VENT	36092
TERMOSTATO-180°	33576	TENSOR-VENT	38523
TERMOSTATO-180°	33578	TENSOR-TOMA DE FUERZA-ALT-VENT-AA	38589
TERMOSTATO-170°	33577	BANDA-TOMA DE FUERZA-ALT-VENT	K060672
		MANGUERA INFERIOR-RAD. A TUBO	21891
		MANGUERA SUPERIOR-RAD. A TUBO	24436

1994

TERMOSTATO-190°	33579	MANGUERA SILICÓN-MOTOR A TUBO	SIH200363C
TERMOSTATO-180°	33576	2004	
TERMOSTATO-180°	33578	BANDA-VENT	K100677
TERMOSTATO-170°	33577	POLEA DEL TENSOR-VENT	36092
		TENSOR-VENT	38523

1993

TERMOSTATO-190°	33579	BANDA-TOMA DE FUERZA-ALT-VENT-AA	K060849
TERMOSTATO-180°	33576	TENSOR-TOMA DE FUERZA-ALT-VENT-AA	38589
TERMOSTATO-180°	33578	MANGUERA INFERIOR-RAD. A TUBO	21891
TERMOSTATO-170°	33577	MANGUERA SUPERIOR-RAD. A TUBO	24436
		MANGUERA SILICÓN-MOTOR A TUBO	SIH200363C

1992

TERMOSTATO-190°	33579	BANDA-ALT-BA-VENT	K060670
TERMOSTATO-180°	33576	2003	
TERMOSTATO-180°	33578	BANDA-VENT	K100677
TERMOSTATO-170°	33577	POLEA DEL TENSOR-VENT	36092
		TENSOR-VENT	38523

1991

TERMOSTATO-190°	33579	BANDA-TOMA DE FUERZA-ALT-VENT-AA	K060849
TERMOSTATO-180°	33576	TENSOR-TOMA DE FUERZA-ALT-VENT-AA	38589
TERMOSTATO-180°	33578	MANGUERA INFERIOR-RAD. A TUBO	21891
TERMOSTATO-170°	33577	MANGUERA SUPERIOR-RAD. A TUBO	24436
		MANGUERA SILICÓN-MOTOR A TUBO	SIH200363C

MACK



CH SERIES

MACK AC DIESEL

2006

MACK 6 CIL, 12.0 L DIESEL

2002

BANDA-VENT-AA	9505	BANDA-ALT-BA-VENT	K060670
MANGUERA INFERIOR-TUBO A RAD.	21891		
MANGUERA SILICÓN-TUBO A RAD.	SIH200363C		
MANGUERA SILICÓN-MOTOR A TUBO	SIH200363C		



MASTER SERVICIO PESADO 2014

MACK

CH SERIES

MANGUERA SILICÓN-MOTOR A TUBO	SIH250363C	POLEA DEL TENSOR-TOMA DE FUERZA-ALT-AA	36095
BANDA-ALT-VENT	K100731	TENSOR-TOMA DE FUERZA-ALT-AA	38532
POLEA-ALT-VENT	36092	MANGUERA INFERIOR-MOTOR A TUBO	CHARTER 2 1/2"
TENSOR-ALT-VENT	38523	MANGUERA SUPERIOR-MOTOR A TUBO	CHARTER 2 1/2"
2001		CHN SERIES	
BANDA-VENT-AA	9505	MACK AC DIESEL	
MANGUERA INFERIOR-TUBO A RAD.	21891	2007	
MANGUERA SILICÓN-TUBO A RAD.	SIH200363C	POLEA DEL TENSOR-VENT	36092
MANGUERA SILICÓN-MOTOR A TUBO	SIH200363C	TENSOR-VENT	38523
MANGUERA SILICÓN-MOTOR A TUBO	SIH250363C	BANDA-TOMA DE FUERZA-ALT-VENT-AA	K060849
BANDA-ALT-VENT	K100731	TENSOR-TOMA DE FUERZA-ALT-VENT-AA	38589
POLEA-ALT-VENT	36092	MANGUERA INFERIOR-RAD. A TUBO	21891
TENSOR-ALT-VENT	38523	MANGUERA SUPERIOR-RAD. A TUBO	21115
CUMMINS SIGNATURE 600 DIESEL		MANGUERA SILICÓN-MOTOR A TUBO	SIH250363C
2003		2006	
BANDA-VENT	K100710	POLEA DEL TENSOR-VENT	36092
POLEA DEL TENSOR-VENT	36092	TENSOR-VENT	38523
TENSOR-VENT	38535	BANDA-TOMA DE FUERZA-ALT-VENT-AA	K060849
MANGUERA INFERIOR-TUBO A RAD.	CHARTER 3"	TENSOR-TOMA DE FUERZA-ALT-VENT-AA	38589
MANGUERA SUPERIOR-TUBO A RAD.	CHARTER 2 1/2"	MANGUERA INFERIOR-RAD. A TUBO	21891
BANDA-TOMA DE FUERZA-ALT-AA	K060685	MANGUERA SUPERIOR-RAD. A TUBO	21115
POLEA DEL TENSOR-TOMA DE FUERZA-ALT-AA	36095	MANGUERA SILICÓN-MOTOR A TUBO	SIH250363C
TENSOR-TOMA DE FUERZA-ALT-AA	38532	CHU SERIES	
MANGUERA INFERIOR-MOTOR A TUBO	CHARTER 2 1/2"	MACK MP8 DIESEL	
MANGUERA SUPERIOR-MOTOR A TUBO	CHARTER 2 1/2"	2010	
2002		MANGUERA SUPERIOR-RAD. A TUBO	21891
BANDA-VENT	K100710	MANGUERA SUPERIOR-RAD. A TUBO	22714
POLEA DEL TENSOR-VENT	36092	MANGUERA SUPERIOR-MOTOR A RAD.	21115
TENSOR-VENT	38535	BANDA-BA-VENT	K120786
MANGUERA INFERIOR-TUBO A RAD.	CHARTER 3"	BANDA-ALT-AA	K080630
MANGUERA SUPERIOR-TUBO A RAD.	CHARTER 2 1/2"	TENSOR-ALT-AA	38632
BANDA-TOMA DE FUERZA-ALT-AA	K060685	TENSOR-ALT-AA	38671
POLEA DEL TENSOR-TOMA DE FUERZA-ALT-AA	36095	2009	
TENSOR-TOMA DE FUERZA-ALT-AA	38532	MANGUERA SUPERIOR-RAD. A TUBO	21891
MANGUERA INFERIOR-MOTOR A TUBO	CHARTER 2 1/2"	MANGUERA SUPERIOR-RAD. A TUBO	22714
MANGUERA SUPERIOR-MOTOR A TUBO	CHARTER 2 1/2"	MANGUERA SUPERIOR-MOTOR A RAD.	21115
2001		BANDA-BA-VENT	K120786
BANDA-VENT	K100710	BANDA-ALT-AA	K080630
POLEA DEL TENSOR-VENT	36092	TENSOR-ALT-AA	38632
TENSOR-VENT	38535	TENSOR-ALT-AA	38671
MANGUERA INFERIOR-TUBO A RAD.	CHARTER 3"	2008	
MANGUERA SUPERIOR-TUBO A RAD.	CHARTER 2 1/2"	MANGUERA SUPERIOR-RAD. A TUBO	21891
BANDA-TOMA DE FUERZA-ALT-AA	K060685	MANGUERA SUPERIOR-RAD. A TUBO	22714



MASTER SERVICIO PESADO 2014

MACK

CHU SERIES

MANGUERA SUPERIOR-MOTOR A RAD.	21115	BANDA-TOMA DE FUERZA-ALT-AA	K060685
BANDA-BA-VENT	K120786	POLEA DEL TENSOR-TOMA DE FUERZA-ALT-AA	36095
BANDA-ALT-AA	K080630	TENSOR-TOMA DE FUERZA-ALT-AA	38532
TENSOR-ALT-AA	38632	MANGUERA INFERIOR-MOTOR A TUBO	CHARTER 2 1/2"
TENSOR-ALT-AA	38671	MANGUERA SUPERIOR-MOTOR A TUBO	CHARTER 2 1/2"

CL SERIES

MACK 6 CIL, 12.0 L DIESEL

2001

BANDA-VENT-AA	9430
MANGUERA INFERIOR-TUBO A MOTOR	CHARTER 2 1/2"
MANGUERA INFERIOR-MOTOR A TUBO	CHARTER 2 1/2"
BANDA-ALT-VENT	K100655
POLEA-ALT-VENT	36092
TENSOR-ALT-VENT	38523

CUMMINS SIGNATURE 600 DIESEL

2003

BANDA-VENT	K100710
POLEA DEL TENSOR-VENT	36092
TENSOR-VENT	38535
MANGUERA INFERIOR-TUBO A RAD.	CHARTER 3"
MANGUERA SUPERIOR-TUBO A RAD.	CHARTER 2 1/2"
BANDA-TOMA DE FUERZA-ALT-AA	K060685
POLEA DEL TENSOR-TOMA DE FUERZA-ALT-AA	36095
TENSOR-TOMA DE FUERZA-ALT-AA	38532
MANGUERA INFERIOR-MOTOR A TUBO	CHARTER 2 1/2"
MANGUERA SUPERIOR-MOTOR A TUBO	CHARTER 2 1/2"

2002

BANDA-VENT	K100710
POLEA DEL TENSOR-VENT	36092
TENSOR-VENT	38535
MANGUERA INFERIOR-TUBO A RAD.	CHARTER 3"
MANGUERA SUPERIOR-TUBO A RAD.	CHARTER 2 1/2"
BANDA-TOMA DE FUERZA-ALT-AA	K060685
POLEA DEL TENSOR-TOMA DE FUERZA-ALT-AA	36095
TENSOR-TOMA DE FUERZA-ALT-AA	38532
MANGUERA INFERIOR-MOTOR A TUBO	CHARTER 2 1/2"
MANGUERA SUPERIOR-MOTOR A TUBO	CHARTER 2 1/2"

2001

BANDA-VENT	K100710
POLEA DEL TENSOR-VENT	36092
TENSOR-VENT	38535
MANGUERA INFERIOR-TUBO A RAD.	CHARTER 3"
MANGUERA SUPERIOR-TUBO A RAD.	CHARTER 2 1/2"

CUMMINS ISX DIESEL

2007

BANDA-TOMA DE FUERZA-AA	K060660
MANGUERA SILICÓN-RAD. A TUBO	SIH250363C
MANGUERA SILICÓN-RAD. A TUBO	SIH300363C
MANGUERA SILICÓN-MOTOR A TUBO	SIH250363C
BANDA-ALT-VENT	K120911
TENSOR-ALT-VENT	38587

2006

BANDA-TOMA DE FUERZA-AA	K060660
MANGUERA SILICÓN-RAD. A TUBO	SIH250363C
MANGUERA SILICÓN-RAD. A TUBO	SIH300363C
MANGUERA SILICÓN-MOTOR A TUBO	SIH250363C
BANDA-ALT-VENT	K120911
TENSOR-ALT-VENT	38587

2005

BANDA-TOMA DE FUERZA-AA	K060660
MANGUERA SILICÓN-RAD. A TUBO	SIH250363C
MANGUERA SILICÓN-RAD. A TUBO	SIH300363C
MANGUERA SILICÓN-MOTOR A TUBO	SIH250363C
BANDA-ALT-VENT	K120911
TENSOR-ALT-VENT	38587

2004

BANDA-TOMA DE FUERZA-AA	K060660
MANGUERA SILICÓN-RAD. A TUBO	SIH250363C
MANGUERA SILICÓN-RAD. A TUBO	SIH300363C
MANGUERA SILICÓN-MOTOR A TUBO	SIH250363C
BANDA-ALT-VENT	K120911
TENSOR-ALT-VENT	38587

CATERPILLAR 3406 DIESEL

2002

TERMOSTATO-190°	33579
TERMOSTATO-180°	33576
TERMOSTATO-180°	33578
TERMOSTATO-170°	33577

2001

TERMOSTATO-190°	33579
TERMOSTATO-180°	33576



TERMOSTATO-180°	33578
TERMOSTATO-170°	33577

CS SERIES**RENAULT 6 CIL, 6.2 L DIESEL**

2001	
BANDA-COMPRESOR	9476
BANDA-COMPRESOR	9490
BANDA-ALT-BA	7490
BANDA-ALT-BA	7512

MACK AC DIESEL

2003	
BANDA-VENT-AA	9500
MANGUERA SILICÓN-TUBO A RAD.	SIH200363C
MANGUERA SILICÓN-TUBO A RAD.	SIH250363C
MANGUERA SUPERIOR-MOTOR A TUBO	22322
BANDA-ALT-VENT	K100658
POLEA-ALT-VENT	36092
TENSOR-ALT-VENT	38523

CT SERIES**MACK AMI DIESEL**

2006	
BANDA-VENT-C/VENT CLUTCH HORTON	K100665
BANDA-VENT- C/VENT CLUTCH BEHR	K100658
BANDA-ALT-VENT-C/VENT CLUTCH HORTON/BORG WARNER	K060660
BANDA-ALT-VENT-AA-C/VENT CLUTCH HORTON/BORG WARNER	K060840
BANDA-ALT-VENT-AA- C/VENT CLUTCH BEHR	K060832
TENSOR-ALT-VENT-AA	38589
BANDA-ALT-VENT- C/VENT CLUTCH BEHR	K060653
POLEA DEL TENSOR-	36092

MACK AI DIESEL

2007	
BANDA-VENT-C/VENT CLUTCH HORTON, RELACIÓN 1.56	K100658
TENSOR-TOMA DE FUERZA-ALT-VENT-AA	38589
MANGUERA INFERIOR-RAD. A TUBO	21115
MANGUERA SUPERIOR-RAD. A TUBO	21115
MANGUERA SILICÓN-MOTOR A TUBO	SIH250363C
BANDA-ALT-VENT-AA-C/VENT CLUTCH BEHR C/PROP. 1.68	K060828
BANDA-ALT-VENT-AA- C/VENT CLUTCH BEHR	K060832
POLEA DEL TENSOR-	36092
2006	
BANDA-VENT-C/VENT CLUTCH HORTON, RELACIÓN 1.56	K100658
MANGUERA INFERIOR-RAD. A TUBO	21115
MANGUERA SUPERIOR-RAD. A TUBO	21115

MANGUERA SILICÓN-MOTOR A TUBO	SIH250363C
BANDA-ALT-VENT-AA-C/VENT CLUTCH BEHR C/PROP. 1.68	K060828
BANDA-ALT-VENT-AA- C/VENT CLUTCH BEHR	K060832
TENSOR-ALT-VENT-AA	38589
POLEA DEL TENSOR-	36092

CTP SERIES**MACK MP7 DIESEL**

2007	
BANDA-VENT	K100731
TENSOR-VENT	38607
MANGUERA SUPERIOR-RAD. A TUBO	21115
MANGUERA INFERIOR-MOTOR A TUBO	21891
MANGUERA SILICÓN-MOTOR A TUBO	SIH250363C
BANDA-ALT-AA	K080630

CV SERIES**MACK EM7 DIESEL**

2003	
TERMOSTATO-195°	33589
TERMOSTATO-180°	33588
TERMOSTATO-170°	33587

MACK AMI DIESEL

2006	
POLEA DEL TENSOR-VENT	36092
TENSOR-VENT	38523
BANDA-ALT-VENT-AA	K060795
BANDA-ALT-VENT	K060625
2005	
BANDA-VENT	K100607
POLEA DEL TENSOR-VENT	36092
TENSOR-VENT	38523
MANGUERA SILICÓN-TUBO A ENFRIADOR	SIH200363C
MANGUERA INFERIOR-RAD. A TUBO	21891
MANGUERA SILICÓN-RAD. A TUBO	SIH200363C
MANGUERA SUPERIOR-MOTOR A TUBO	24436
MANGUERA SILICÓN-ENFRIADOR A TUBO	SIH250363C
BANDA-ALT-VENT-AA	K060795
TENSOR-ALT-VENT-AA	38589
2004	
BANDA-VENT-AA	9500
BANDA-VENT	K100607
POLEA DEL TENSOR-VENT	36092
TENSOR-VENT	38523
MANGUERA INFERIOR-RAD. A TUBO	21891



MASTER SERVICIO PESADO 2014

MACK

CV SERIES

MANGUERA SILICÓN-RAD. A TUBO	SIH200363C	BANDA-ALT-BA-VENT	K060795
MANGUERA SILICÓN-MOTOR A TUBO	SIH200363C	MANGUERA INFERIOR-	CHARTER 2 1/2"
BANDA-ALT-VENT-AA	K060795	MANGUERA INFERIOR-	CHARTER 2"
TENSOR-ALT-VENT-AA	38589	MANGUERA SUPERIOR-	CHARTER 2 1/4"
BANDA-ALT-VENT	K100658	MANGUERA SUPERIOR-	CHARTER 2"
POLEA-ALT-VENT	36092	2003	
2003		BANDA-VENT-AA	9500
BANDA-VENT-AA	9500	MANGUERA SILICÓN-RAD. A TUBO	SIH200363C
MANGUERA INFERIOR-TUBO A RAD.	21194	MANGUERA SILICÓN-RAD. A TUBO	SIH250363C
MANGUERA SILICÓN-TUBO A RAD.	SIH200363C	MANGUERA SILICÓN-MOTOR A TUBO	SIH200363C
MANGUERA SILICÓN-MOTOR A TUBO	SIH200363C	BANDA-ALT-VENT	K100658
BANDA-ALT-VENT	K100665	POLEA-ALT-VENT	36092
POLEA-ALT-VENT	36092	TENSOR-ALT-VENT	38523
TENSOR-ALT-VENT	38523	MACK 6 CIL, 12.0 L DIESEL	
MACK AI DIESEL		2002	
2007		BANDA-VENT-AA	9500
BANDA-VENT	K100607	MANGUERA SILICÓN-TUBO A RAD.	SIH200363C
POLEA DEL TENSOR-VENT	36092	MANGUERA SILICÓN-TUBO A RAD.	SIH250363C
TENSOR-VENT	38523	MANGUERA INFERIOR-MOTOR A TUBO	21194
MANGUERA SILICÓN-TUBO A ENFRIADOR	SIH200363C	MANGUERA SILICÓN-MOTOR A TUBO	SIH200363C
MANGUERA INFERIOR-RAD. A TUBO	21891	BANDA-ALT-VENT	K100655
MANGUERA SILICÓN-RAD. A TUBO	SIH200363C	POLEA-ALT-VENT	36092
MANGUERA SUPERIOR-MOTOR A TUBO	24436	TENSOR-ALT-VENT	38523
MANGUERA SILICÓN-ENFRIADOR A TUBO	SIH250363C	2001	
BANDA-ALT-VENT-AA	K060795	BANDA-VENT-AA	9500
TENSOR-ALT-VENT-AA	38589	MANGUERA SILICÓN-TUBO A RAD.	SIH200363C
BANDA-ALT-VENT	K060625	MANGUERA SILICÓN-TUBO A RAD.	SIH250363C
2006		MANGUERA INFERIOR-MOTOR A TUBO	21194
BANDA-VENT	K100607	MANGUERA SILICÓN-MOTOR A TUBO	SIH200363C
POLEA DEL TENSOR-VENT	36092	BANDA-ALT-VENT	K100655
TENSOR-VENT	38523	POLEA-ALT-VENT	36092
MANGUERA SILICÓN-TUBO A ENFRIADOR	SIH200363C	TENSOR-ALT-VENT	38523
MANGUERA INFERIOR-RAD. A TUBO	21891	CX SERIES	
MANGUERA SILICÓN-RAD. A TUBO	SIH200363C	MACK AC DIESEL	
MANGUERA SUPERIOR-MOTOR A TUBO	24436	2006	
MANGUERA SILICÓN-ENFRIADOR A TUBO	SIH250363C	BANDA-VENT	K100554
BANDA-ALT-VENT-AA	K060795	POLEA DEL TENSOR-VENT	36092
TENSOR-ALT-VENT-AA	38589	MANGUERA SILICÓN-TUBO A RAD.	SIH200363C
BANDA-ALT-VENT	K060625	MANGUERA SUPERIOR-MOTOR A TUBO	24436
2005		BANDA-ALT-VENT-AA	K060735
BANDA-VENT	K100607	TENSOR-ALT-VENT-AA	38589
TENSOR-VENT	38523	BANDA-ALT-VENT	K060586
MANGUERA INFERIOR-RAD. A TUBO	21891	TENSOR-ALT-VENT	38617



MASTER SERVICIO PESADO 2014

MACK

CX SERIES

2005

BANDA-VENT	K100554
POLEA DEL TENSOR-VENT	36092
TENSOR-VENT	38611
MANGUERA SILICÓN-TUBO A RAD.	SIH200363C
MANGUERA SUPERIOR-MOTOR A TUBO	24436
BANDA-ALT-VENT-AA	K060735
TENSOR-ALT-VENT-AA	38589
BANDA-ALT-VENT	K060586

2004

BANDA-VENT	K100554
POLEA DEL TENSOR-VENT	36092
TENSOR-VENT	38611
MANGUERA SILICÓN-TUBO A RAD.	SIH200363C
MANGUERA SUPERIOR-MOTOR A TUBO	24436
BANDA-ALT-VENT-AA	K060735
TENSOR-ALT-VENT-AA	38589

2003

BANDA-VENT	K100554
POLEA DEL TENSOR-VENT	36092
TENSOR-VENT	38611
MANGUERA SILICÓN-TUBO A RAD.	SIH200363C
MANGUERA SUPERIOR-MOTOR A TUBO	24436
BANDA-ALT-VENT-AA	K060735
TENSOR-ALT-VENT-AA	38589

MACK 6 CIL, 12.0 L DIESEL

2002

BANDA-VENT-COMPRESOR	9490
MANGUERA SILICÓN-TUBO A RAD.	SIH200363C
MANGUERA SILICÓN-MOTOR A TUBO	SIH200363C
BANDA-ALT-VENT	K100607
POLEA-ALT-VENT	36092
TENSOR-ALT-VENT	38523

2001

BANDA-VENT-COMPRESOR	9490
MANGUERA SILICÓN-TUBO A RAD.	SIH200363C
MANGUERA SILICÓN-MOTOR A TUBO	SIH200363C
MANGUERA SILICÓN-MOTOR A TUBO	SIH250363C
BANDA-ALT-VENT	K100665
POLEA-ALT-VENT	36092
TENSOR-ALT-VENT	38523

CXN SERIES

MACK AC DIESEL

2007

BANDA-VENT-C/VENT CLUTCH BORG WARNER, HORTON	K100579
POLEA DEL TENSOR-VENT	36092
TENSOR-VENT	38523
MANGUERA INFERIOR-RAD. A TUBO	21115
MANGUERA SUPERIOR-RAD. A TUBO	21115
MANGUERA SUPERIOR-MOTOR A TUBO	24436
BANDA-ALT-VENT-AA-C/VENT CLUTCH BORG WARNER, HORTON	K060747
BANDA-ALT-VENT-AA- C/VENT CLUTCH BEHR	K060739
TENSOR-ALT-VENT-AA	38589

2006

BANDA-VENT-C/VENT CLUTCH HORTON/BORG WARNER, RELAC. 1.39 A 1	K100579
POLEA DEL TENSOR-VENT	36092
TENSOR-VENT	38523
MANGUERA INFERIOR-RAD. A TUBO	21115
MANGUERA SUPERIOR-RAD. A TUBO	21115
MANGUERA SUPERIOR-MOTOR A TUBO	24436
BANDA-ALT-VENT-AA-C/VENT CLUTCH HORTON/BORG WARNER	K060747
BANDA-ALT-VENT-AA- C/VENT CLUTCH BEHR	K060739
TENSOR-ALT-VENT-AA	38589

CXP SERIES

MACK MP7 DIESEL

2007

BANDA-VENT	K100630
TENSOR-VENT	38607
MANGUERA SUPERIOR-RAD. A TUBO	21115
MANGUERA SILICÓN-MOTOR A TUBO	SIH250363C
BANDA-ALT-AA	K080630

2006

TENSOR-TOMA DE FUERZA-VENT	38589
MANGUERA INFERIOR-RAD. A TUBO	21891
MANGUERA SILICÓN-RAD. A TUBO	SIH250363C
MANGUERA INFERIOR-MOTOR A TUBO	21891
MANGUERA SILICÓN-MOTOR A TUBO	SIH250363C
BANDA-ALT-AA	K080630
TENSOR-ALT-AA	38523

CXU SERIES

MACK MP8 DIESEL

2010

MANGUERA SUPERIOR-TUBO A MOTOR	22714
BANDA-BA-VENT	K120640
TENSOR-BA-VENT	38633
TENSOR-ALT-AA OPCIÓN 1	38671



MASTER SERVICIO PESADO 2014

MACK

CXU SERIES

BANDA- ALT-AA OPCIÓN 2	K080590	MANGUERA SUPERIOR-RAD. A TUBO	22714
BANDA- ALT-AA OPCIÓN 1	K080630	MANGUERA SUPERIOR-MOTOR A RAD.	21115
MANGUERA INFERIOR-	23563	BANDA-BA-VENT	K120786
2009		BANDA-ALT-AA	K080630
MANGUERA SUPERIOR-TUBO A MOTOR	22714	TENSOR-ALT-AA	38632
BANDA-BA-VENT	K120640	TENSOR-ALT-AA	38671
TENSOR-BA-VENT	38633	2012	
TENSOR-ALT-AA OPCIÓN 1	38671	MANGUERA SUPERIOR-RAD. A TUBO	21891
BANDA- ALT-AA OPCIÓN 2	K080590	MANGUERA SUPERIOR-RAD. A TUBO	22714
BANDA- ALT-AA OPCIÓN 1	K080630	MANGUERA SUPERIOR-MOTOR A RAD.	21115
MANGUERA INFERIOR-	23563	BANDA-BA-VENT	K120786
2008		BANDA-ALT-AA	K080630
MANGUERA SUPERIOR-TUBO A MOTOR	22714	TENSOR-ALT-AA	38632
BANDA-BA-VENT	K120640	TENSOR-ALT-AA	38671
TENSOR-BA-VENT	38633	2011	
BANDA-ALT-AA OPCIÓN 1	K080630	MANGUERA SUPERIOR-RAD. A TUBO	21891
TENSOR-ALT-AA OPCIÓN 1	38671	MANGUERA SUPERIOR-RAD. A TUBO	22714
BANDA- ALT-AA OPCIÓN 2	K080590	MANGUERA SUPERIOR-MOTOR A RAD.	21115
MANGUERA INFERIOR-	23563	BANDA-BA-VENT	K120786

DM SERIES

MACK EM7 DIESEL

2004			
TERMOSTATO-195°	33589		
TERMOSTATO-180°	33588		
TERMOSTATO-170°	33587		
2003			
TERMOSTATO-195°	33589		
TERMOSTATO-180°	33588		
TERMOSTATO-170°	33587		

MACK 6 CIL, 12.0 L DIESEL

2001			
BANDA-VENT-AA	9430		
MANGUERA SUPERIOR-TUBO A RAD.	CHARTER 2 1/2"		
MANGUERA INFERIOR-TUBO A MOTOR	21891		
MANGUERA INFERIOR-MOTOR A TUBO	CHARTER 2 1/2"		
MANGUERA SUPERIOR-MOTOR A TUBO	CHARTER 2 1/2"		
BANDA-ALT-VENT	K100655		
POLEA-ALT-VENT	36092		
TENSOR-ALT-VENT	38523		

GRANITE

MACK MP8 DIESEL

2013			
MANGUERA SUPERIOR-RAD. A TUBO	21891		

GU SERIES

MACK MP8 DIESEL

2010			
POLEA-VENT		36285	
MANGUERA SUPERIOR-MOTOR A TUBO		22714	
BANDA-BA-VENT OPCIÓN2		K100764	
BANDA-BA-VENT OPCIÓN1		K120786	
TENSOR-BA-VENT		38632	
BANDA-ALT-AA		K080630	
TENSOR-ALT-AA		38671	
2009			
POLEA-VENT		36285	
MANGUERA SUPERIOR-MOTOR A TUBO		22714	
BANDA-BA-VENT OPCIÓN2		K100764	
BANDA-BA-VENT OPCIÓN1		K120786	
TENSOR-BA-VENT		38632	
BANDA-ALT-AA		K080630	
TENSOR-ALT-AA		38671	
2008			
POLEA-VENT		36285	
MANGUERA SUPERIOR-MOTOR A TUBO		22714	



BANDA-BA-VENT OPCIÓN2	K100764	BANDA-VENT	K100554
BANDA-BA-VENT OPCIÓN1	K120786	BANDA-ALT-VENT-AA	K060716
TENSOR-BA-VENT	38632	TENSOR-ALT-VENT-AA	38599
BANDA-ALT-AA	K080630	2005	
TENSOR-ALT-AA	38671	BANDA-VENT	K100554

LE SERIES**MACK AMI DIESEL**

2007		TENSOR-VENT	38599
BANDA-VENT-AA	K100554	BANDA-ALT-BA-AA	K060716
BANDA-ALT-BA	K060716	TENSOR-ALT-BA-AA	38589

MACK AI DIESEL

2006		2004	
BANDA-VENT	K100554	BANDA-VENT	K100554
BANDA-ALT-VENT-AA	K060716	TENSOR-VENT	38599
TENSOR-ALT-VENT-AA	38599	BANDA-ALT-BA-AA	K060716

2005		TENSOR-ALT-BA-AA	38589
BANDA-VENT	K100610	2003	
BANDA-ALT-VENT-AA	K060716	BANDA-VENT	K100554
TENSOR-ALT-VENT-AA	38599	TENSOR-VENT	38599

BANDA-	9395	BANDA-ALT-BA-AA	K060716
2004		TENSOR-ALT-BA-AA	38589
BANDA-VENT	K100610	MACK AI DIESEL	
TENSOR-MOTOR	38599	2006	

POLEA-ALT-VENT	36092	BANDA-VENT	K100554
TENSOR-ALT-VENT	38523	BANDA-ALT-VENT-AA	K060716
BANDA-	9395	TENSOR-ALT-VENT-AA	38599

2004		2005	
BANDA-VENT	K100610	BANDA-VENT	K100554
TENSOR-MOTOR	38599	BANDA-ALT-VENT-AA	K060716
POLEA-ALT-VENT	36092	TENSOR-ALT-VENT-AA	38599

TENSOR-ALT-VENT	38523	MACK 6 CIL, 12.0 L DIESEL	
2003		2002	
BANDA-VENT	K100610	BANDA-VENT-AA	9390
POLEA-ALT-VENT	36092	MANGUERA SILICÓN-TUBO A RAD.	SIH200363C

TENSOR-ALT-VENT	38523	MANGUERA SILICÓN-TUBO A RAD.	SIH250363C
2004		MANGUERA SILICÓN-MOTOR A TUBO	SIH200363C
BANDA-VENT	K100610	MANGUERA SILICÓN-MOTOR A TUBO	SIH250363C

MACK EM7 DIESEL		BANDA-ALT-VENT	K100607
2003		POLEA-ALT-VENT	36092
TERMOSTATO-195°	33589	TENSOR-ALT-VENT	38523

TERMOSTATO-180°	33588	2001	
TERMOSTATO-170°	33587	BANDA-VENT-AA	9390
MACK AMI DIESEL		MANGUERA SILICÓN-TUBO A RAD.	SIH200363C

2007		MANGUERA SILICÓN-TUBO A RAD.	SIH250363C
BANDA-VENT-AA	K100554	MANGUERA SILICÓN-MOTOR A TUBO	SIH200363C
TENSOR-VENT-AA	38599	MANGUERA SILICÓN-MOTOR A TUBO	SIH250363C

BANDA-ALT-BA	K060716	MANGUERA SILICÓN-MOTOR A TUBO	SIH250363C
2006			



BANDA-ALT-VENT	K100607
POLEA-ALT-VENT	36092
TENSOR-ALT-VENT	38523

RB SERIES**MACK EM7 DIESEL****2004**

TERMOSTATO-195°	33589
TERMOSTATO-180°	33588
TERMOSTATO-170°	33587

2003

TERMOSTATO-195°	33589
TERMOSTATO-180°	33588
TERMOSTATO-170°	33587

RD SERIES**MACK EM7 DIESEL****2004**

TERMOSTATO-195°	33589
TERMOSTATO-180°	33588
TERMOSTATO-170°	33587

2003

TERMOSTATO-195°	33589
TERMOSTATO-180°	33588
TERMOSTATO-170°	33587

MACK 6 CIL, 12.0 L DIESEL**2002**

BANDA-VENT-AA	9430
BANDA-ALT-VENT	K100655
POLEA-ALT-VENT	36092
TENSOR-ALT-VENT	38523

2001

BANDA-VENT-AA	9430
MANGUERA SILICÓN-TUBO A RAD.	SIH200363C
MANGUERA SILICÓN-TUBO A RAD.	SIH250363C
MANGUERA SILICÓN-MOTOR A TUBO	SIH200363C
MANGUERA SILICÓN-MOTOR A TUBO	SIH250363C
BANDA-ALT-VENT	K100655
POLEA-ALT-VENT	36092
TENSOR-ALT-VENT	38523

MASA**ESTRADA****DETROIT DIESEL SERIE 60****2000**

BANDA-VENT	BX92
BANDA-ALT	PQ17510
BANDA-AA	PQ24895

1999

BANDA-VENT	BX92
BANDA-ALT	PQ17510
BANDA-AA	PQ24895

1998

BANDA-VENT	BX92
BANDA-ALT	PQ17510
BANDA-AA	PQ24895

1997

BANDA-VENT	BX92
BANDA-ALT	PQ17510
BANDA-AA	PQ24895

DETROIT DIESEL SERIE 50**2000**

BANDA-VENT	BX92
BANDA-VENT	BX93
BANDA-ALT	2/9500PB
BANDA-AA	BX89

1999

BANDA-VENT	BX92
BANDA-VENT	BX93
BANDA-ALT	2/9500PB

1998

BANDA-AA	BX89
BANDA-VENT	BX92
BANDA-VENT	BX93

1997

BANDA-AA	BX89
BANDA-VENT	BX92
BANDA-VENT	BX93

1996

BANDA-VENT	BX92
BANDA-ALT	2/9500PB
BANDA-ALT	PQ17490
BANDA-AA	BX89

PREMIER**DETROIT DIESEL V6****1996**

BANDA-VENT	BX90
------------	------



MASTER SERVICIO PESADO 2014

MASA

PREMIER

BANDA-VENT	PQ24895	BANDA-ALT-AA	PQ17470
BANDA-ALT	PQ17470	BANDA-ALT1-BA	AX67
1995		BANDA-AA	BX90
BANDA-VENT	BX90	TERMOSTATO-190°	33079
BANDA-VENT	PQ24895	TERMOSTATO-180°	33078
BANDA-ALT	PQ17470	MANGUERA INFERIOR-	CHARTER 2"
1994		MANGUERA SUPERIOR-	CH-170001
BANDA-VENT	BX90	1996	
BANDA-VENT	PQ24895	BANDA-VENT	2/9104PK
BANDA-ALT	PQ17470	BANDA-ALT-AA	PQ17470
1993		BANDA-ALT1-BA	AX67
BANDA-VENT	BX90	BANDA-AA	BX90
BANDA-VENT	PQ24895	TERMOSTATO-190°	33079
BANDA-ALT	PQ17470	TERMOSTATO-180°	33078

DETROIT DIESEL SERIE 60

1996		MANGUERA INFERIOR-	CHARTER 2"
BANDA-VENT	BX83	MANGUERA SUPERIOR-	CH-170001
BANDA-ALT	PQ17470	1995	
1995		BANDA-VENT	2/9104PK
BANDA-VENT	BX83	BANDA-ALT-AA	PQ17470
BANDA-ALT	PQ17470	BANDA-ALT1-BA	AX67
1994		BANDA-AA	BX90
BANDA-VENT	BX83	TERMOSTATO-190°	33079
BANDA-ALT	PQ17470	TERMOSTATO-180°	33078
1993		MANGUERA INFERIOR-	CHARTER 2"
BANDA-VENT	BX83	MANGUERA SUPERIOR-	CH-170001
BANDA-ALT	PQ17470	1994	

MERCEDES BENZ



0371 RS

OM 447

1998		BANDA-VENT	2/9104PK
BANDA-VENT	2/9104PK	MANGUERA INFERIOR-	CHARTER 2"
BANDA-ALT-AA	PQ17470	MANGUERA SUPERIOR-	CH-170001
BANDA-ALT1-BA	AX67	1993	
BANDA-AA	BX90	BANDA-VENT	2/9104PK
TERMOSTATO-190°	33079	BANDA-ALT-AA	PQ17470
TERMOSTATO-180°	33078	BANDA-ALT1-BA	AX67
MANGUERA INFERIOR-	CHARTER 2"	BANDA-AA	BX90
MANGUERA SUPERIOR-	CH-170001	TERMOSTATO-190°	33079
1997		TERMOSTATO-180°	33078
BANDA-VENT	2/9104PK	MANGUERA INFERIOR-	CHARTER 2"
		MANGUERA SUPERIOR-	CH-170001



MASTER SERVICIO PESADO 2014

MERCEDES BENZ

0371 RS

1992			MANGUERA SUPERIOR-	CH-170001
BANDA-VENT	2/9104PK	1996		
BANDA-ALT-AA	PQ17470	BANDA-VENT		2/9100PK
BANDA-ALT1-BA	AX67	BANDA-BA		9690
BANDA-AA	BX90	BANDA-ALT		PQ17500
TERMOSTATO-190°	33079	TERMOSTATO-190°		33079
TERMOSTATO-180°	33078	TERMOSTATO-180°		33078
MANGUERA INFERIOR-	CHARTER 2"	MANGUERA INFERIOR-		CHARTER 2"
MANGUERA SUPERIOR-	CH-170001	MANGUERA SUPERIOR-		CH-170001
1991		1995		
BANDA-VENT	2/9104PK	BANDA-VENT		2/9100PK
BANDA-ALT-AA	PQ17470	BANDA-BA		9690
BANDA-ALT1-BA	AX67	BANDA-ALT		PQ17500
BANDA-AA	BX90	TERMOSTATO-190°		33079
TERMOSTATO-190°	33079	TERMOSTATO-180°		33078
TERMOSTATO-180°	33078	MANGUERA INFERIOR-		CHARTER 2"
MANGUERA INFERIOR-	CHARTER 2"	MANGUERA SUPERIOR-		CH-170001
MANGUERA SUPERIOR-	CH-170001	1994		
1990		BANDA-VENT		2/9100PK
BANDA-VENT	2/9104PK	BANDA-BA		9690
BANDA-ALT-AA	PQ17470	BANDA-ALT		PQ17500
BANDA-ALT1-BA	AX67	TERMOSTATO-190°		33079
BANDA-AA	BX90	TERMOSTATO-180°		33078
TERMOSTATO-190°	33079	MANGUERA INFERIOR-		CHARTER 2"
TERMOSTATO-180°	33078	MANGUERA SUPERIOR-		CH-170001
MANGUERA INFERIOR-	CHARTER 2"	1993		
MANGUERA SUPERIOR-	CH-170001	BANDA-VENT		2/9100PK
OM 355		BANDA-BA		9690
1998		BANDA-ALT		PQ17500
BANDA-VENT	2/9100PK	TERMOSTATO-190°		33079
BANDA-BA	9690	TERMOSTATO-180°		33078
BANDA-ALT	PQ17500	MANGUERA INFERIOR-		CHARTER 2"
TERMOSTATO-190°	33079	MANGUERA SUPERIOR-		CH-170001
TERMOSTATO-180°	33078	1992		
MANGUERA INFERIOR-	CHARTER 2"	BANDA-VENT		2/9100PK
MANGUERA SUPERIOR-	CH-170001	BANDA-BA		9690
1997		BANDA-ALT		PQ17500
BANDA-VENT	2/9100PK	TERMOSTATO-190°		33079
BANDA-BA	9690	TERMOSTATO-180°		33078
BANDA-ALT	PQ17500	MANGUERA INFERIOR-		CHARTER 2"
TERMOSTATO-190°	33079	MANGUERA SUPERIOR-		CH-170001
TERMOSTATO-180°	33078	1991		
MANGUERA INFERIOR-	CHARTER 2"	BANDA-VENT		2/9100PK



MASTER SERVICIO PESADO 2014

MERCEDES BENZ

0371 RS

BANDA-BA	9690	1994	
BANDA-ALT	PQ17500	BANDA-VENT	8416 GS
TERMOSTATO-190°	33079	BANDA-ALT	PQ17530
TERMOSTATO-180°	33078	MANGUERA INFERIOR-	CH-170005
MANGUERA INFERIOR-	CHARTER 2"	MANGUERA SUPERIOR-	CH-170001
MANGUERA SUPERIOR-	CH-170001	MANGUERA SUPERIOR FLEXIBLE-	17T165
1990		1993	
BANDA-VENT	2/9100PK	BANDA-VENT	8416 GS
BANDA-BA	9690	BANDA-ALT	PQ17530
BANDA-ALT	PQ17500	MANGUERA INFERIOR-	CH-170005
TERMOSTATO-190°	33079	MANGUERA SUPERIOR-	CH-170001
TERMOSTATO-180°	33078	MANGUERA SUPERIOR FLEXIBLE-	17T165
MANGUERA INFERIOR-	CHARTER 2"	1992	
MANGUERA SUPERIOR-	CH-170001	BANDA-VENT	8416 GS
1114		BANDA-ALT	PQ17530
OM 366		MANGUERA INFERIOR-	CH-170005
1994		MANGUERA SUPERIOR-	CH-170001
BANDA-ALT	PQ17530	MANGUERA SUPERIOR FLEXIBLE-	17T165
MANGUERA INFERIOR-	CH-170005	1991	
MANGUERA SUPERIOR-	CH-170001	BANDA-VENT	8416 GS
MANGUERA SUPERIOR FLEXIBLE-	17T165	BANDA-ALT	PQ17530
1993		MANGUERA INFERIOR-	CH-170005
BANDA-ALT	PQ17530	MANGUERA SUPERIOR-	CH-170001
MANGUERA INFERIOR-	CH-170005	MANGUERA SUPERIOR FLEXIBLE-	17T165
MANGUERA SUPERIOR-	CH-170001	1990	
MANGUERA SUPERIOR FLEXIBLE-	17T165	BANDA-VENT	8416 GS
1992		BANDA-ALT	PQ17530
BANDA-ALT	PQ17530	MANGUERA INFERIOR-	CH-170005
MANGUERA INFERIOR-	CH-170005	MANGUERA SUPERIOR-	CH-170001
MANGUERA SUPERIOR-	CH-170001	MANGUERA SUPERIOR FLEXIBLE-	17T165
MANGUERA SUPERIOR FLEXIBLE-	17T165	1317	
1991		OM 366	
BANDA-ALT	PQ17530	1994	
MANGUERA INFERIOR-	CH-170005	BANDA-VENT	PQ17400
MANGUERA SUPERIOR-	CH-170001	BANDA-ALT	8563 GS
MANGUERA SUPERIOR FLEXIBLE-	17T165	MANGUERA INFERIOR-	CH-170005
1990		MANGUERA SUPERIOR-	CH-170001
BANDA-ALT	PQ17530	MANGUERA SUPERIOR FLEXIBLE-	17T165
MANGUERA INFERIOR-	CH-170005	1993	
MANGUERA SUPERIOR-	CH-170001	BANDA-VENT	PQ17400
MANGUERA SUPERIOR FLEXIBLE-	17T165	BANDA-ALT	8563 GS
1314		MANGUERA INFERIOR-	CH-170005
OM 366		MANGUERA SUPERIOR-	CH-170001



MANGUERA SUPERIOR FLEXIBLE-	17T165
1992	
BANDA-VENT	PQ17400
BANDA-ALT	8563 GS
MANGUERA INFERIOR-	CH-170005
MANGUERA SUPERIOR-	CH-170001
MANGUERA SUPERIOR FLEXIBLE-	17T165
1991	
BANDA-VENT	PQ17400
BANDA-ALT	8563 GS
MANGUERA INFERIOR-	CH-170005
MANGUERA SUPERIOR-	CH-170001
MANGUERA SUPERIOR FLEXIBLE-	17T165
1990	
BANDA-VENT	PQ17400
BANDA-ALT	8563 GS
MANGUERA INFERIOR-	CH-170005
MANGUERA SUPERIOR-	CH-170001
MANGUERA SUPERIOR FLEXIBLE-	17T165
1417	
OM 366	
1994	
BANDA-BA	PQ17530
BANDA-ALT	8405 GS
MANGUERA INFERIOR-	CH-170005
MANGUERA SUPERIOR-	CH-170001
MANGUERA SUPERIOR FLEXIBLE-	17T165
1993	
BANDA-BA	PQ17530
BANDA-ALT	8405 GS
MANGUERA INFERIOR-	CH-170005
MANGUERA SUPERIOR-	CH-170001
MANGUERA SUPERIOR FLEXIBLE-	17T165
1992	
BANDA-BA	PQ17530
BANDA-ALT	8405 GS
MANGUERA INFERIOR-	CH-170005
MANGUERA SUPERIOR-	CH-170001
MANGUERA SUPERIOR FLEXIBLE-	17T165
1991	
BANDA-BA	PQ17530
BANDA-ALT	8405 GS
MANGUERA INFERIOR-	CH-170005

MANGUERA SUPERIOR-	CH-170001
MANGUERA SUPERIOR FLEXIBLE-	17T165
1990	
BANDA-BA	PQ17530
BANDA-ALT	8405 GS
MANGUERA INFERIOR-	CH-170005
MANGUERA SUPERIOR-	CH-170001
MANGUERA SUPERIOR FLEXIBLE-	17T165
1517	
OM 366	
1994	
BANDA-VENT	PQ17540
BANDA-BA	PQ17430
BANDA-ALT	PQ17530
MANGUERA INFERIOR-	CH-170005
MANGUERA SUPERIOR-	CH-170001
MANGUERA SUPERIOR FLEXIBLE-	17T165
1993	
BANDA-VENT	PQ17540
BANDA-BA	PQ17430
BANDA-ALT	PQ17530
MANGUERA INFERIOR-	CH-170005
MANGUERA SUPERIOR-	CH-170001
MANGUERA SUPERIOR FLEXIBLE-	17T165
1992	
BANDA-VENT	PQ17540
BANDA-BA	PQ17430
BANDA-ALT	PQ17530
MANGUERA INFERIOR-	CH-170005
MANGUERA SUPERIOR-	CH-170001
MANGUERA SUPERIOR FLEXIBLE-	17T165
1991	
BANDA-VENT	PQ17540
BANDA-BA	PQ17430
BANDA-ALT	PQ17530
MANGUERA INFERIOR-	CH-170005
MANGUERA SUPERIOR-	CH-170001
MANGUERA SUPERIOR FLEXIBLE-	17T165
1990	
BANDA-VENT	PQ17540
BANDA-BA	PQ17430
BANDA-ALT	PQ17530
MANGUERA INFERIOR-	CH-170005



MANGUERA SUPERIOR- CH-170001
 MANGUERA SUPERIOR FLEXIBLE- 17T165

1521

OM 366

1994
 BANDA-ALT PQ17530

MANGUERA INFERIOR- CH-170005

MANGUERA SUPERIOR- CH-170001

MANGUERA SUPERIOR FLEXIBLE- 17T165

1993

BANDA-ALT PQ17530

MANGUERA INFERIOR- CH-170005

MANGUERA SUPERIOR- CH-170001

MANGUERA SUPERIOR FLEXIBLE- 17T165

1992

BANDA-ALT PQ17530

MANGUERA INFERIOR- CH-170005

MANGUERA SUPERIOR- CH-170001

MANGUERA SUPERIOR FLEXIBLE- 17T165

1991

BANDA-ALT PQ17530

MANGUERA INFERIOR- CH-170005

MANGUERA SUPERIOR- CH-170001

MANGUERA SUPERIOR FLEXIBLE- 17T165

1990

BANDA-ALT PQ17530

MANGUERA INFERIOR- CH-170005

MANGUERA SUPERIOR- CH-170001

MANGUERA SUPERIOR FLEXIBLE- 17T165

2121

OM 366

1994
 BANDA-ALT PQ17530

MANGUERA INFERIOR- CH-170005

MANGUERA SUPERIOR- CH-170001

MANGUERA SUPERIOR FLEXIBLE- 17T165

1993

BANDA-ALT PQ17530

MANGUERA INFERIOR- CH-170005

MANGUERA SUPERIOR- CH-170001

MANGUERA SUPERIOR FLEXIBLE- 17T165

1992

BANDA-ALT PQ17530

MANGUERA INFERIOR- CH-170005

MANGUERA SUPERIOR- CH-170001

MANGUERA SUPERIOR FLEXIBLE- 17T165

1991

BANDA-ALT PQ17530

MANGUERA INFERIOR- CH-170005

MANGUERA SUPERIOR- CH-170001

MANGUERA SUPERIOR FLEXIBLE- 17T165

1990

BANDA-ALT PQ17530

MANGUERA INFERIOR- CH-170005

MANGUERA SUPERIOR- CH-170001

MANGUERA SUPERIOR FLEXIBLE- 17T165

ALBATROS

MB 447

2006

BANDA-VENT-TEMPLADOR AX57

BANDA-TEMPLADOR AX67

BANDA-COMPRESOR (OPCIÓN 2) BX88

BANDA-COMPRESOR (OPCIÓN 1) 2/B88

BANDA-ALT-COMPRESOR AX47

BANDA-ALT-BA AX67

2005

BANDA-VENT-TEMPLADOR AX57

BANDA-TEMPLADOR AX67

BANDA-COMPRESOR (OPCIÓN 2) BX88

BANDA-COMPRESOR (OPCIÓN 1) 2/B88

BANDA-ALT-COMPRESOR AX47

BANDA-ALT-AA AX67

2004

BANDA-VENT-TEMPLADOR AX57

BANDA-TEMPLADOR AX67

BANDA-COMPRESOR (OPCIÓN 2) BX88

BANDA-COMPRESOR (OPCIÓN 1) 2/B88

BANDA-ALT-COMPRESOR AX47

BANDA-ALT-AA AX67

2003

BANDA-VENT-TEMPLADOR AX57

BANDA-TEMPLADOR AX67

BANDA-COMPRESOR (OPCIÓN 2) BX88

BANDA-COMPRESOR (OPCIÓN 1) 2/B88

BANDA-ALT-COMPRESOR AX47

BANDA-ALT-AA AX67



2002

BANDA-VENT-TEMPLADOR	AX57
BANDA-TEMPLADOR	AX67
BANDA-COMPRESOR (OPCIÓN 2)	BX88
BANDA-COMPRESOR (OPCIÓN 1)	2/B88
BANDA-ALT-COMPRESOR	AX47
BANDA-ALT-AA	AX67

2001

BANDA-VENT-TEMPLADOR	AX57
BANDA-TEMPLADOR	AX67
BANDA-COMPRESOR (OPCIÓN 2)	BX88
BANDA-COMPRESOR (OPCIÓN 1)	2/B88
BANDA-ALT-COMPRESOR	AX47
BANDA-ALT-AA	AX67

2000

BANDA-VENT-TEMPLADOR	AX57
BANDA-TEMPLADOR	AX67
BANDA-COMPRESOR (OPCIÓN 2)	BX88
BANDA-COMPRESOR (OPCIÓN 1)	2/B88
BANDA-ALT-COMPRESOR	AX47
BANDA-ALT-AA	AX67

ALEGRO

MB 1623

2010

BANDA-VENT-TEMPLADOR	AX44
BANDA-TEMPLADOR	AX68
BANDA-ALT-BA	K080570

2009

BANDA-VENT-TEMPLADOR	AX44
BANDA-TEMPLADOR	AX68
BANDA-ALT-BA	K080570

2008

BANDA-VENT-TEMPLADOR	AX44
BANDA-TEMPLADOR	AX68
BANDA-ALT-BA	K080570

2007

BANDA-VENT-TEMPLADOR	AX44
BANDA-TEMPLADOR	AX68
BANDA-ALT-BA	K080570

2006

BANDA-VENT-TEMPLADOR	AX44
BANDA-TEMPLADOR	AX68
BANDA-ALT-BA	K080570

2005

BANDA-VENT-TEMPLADOR	AX44
BANDA-TEMPLADOR	AX68
BANDA-ALT-BA	K080570

2004

BANDA-VENT-TEMPLADOR	AX44
BANDA-TEMPLADOR	AX68
BANDA-ALT-BA	K080570

AUTOBUS INTEGRAL

OM 449 LA

1996

BANDA-VENT	2/9104PK
BANDA-ALT	AX67

1995

BANDA-VENT	2/9104PK
BANDA-ALT	AX67

1994

BANDA-VENT	2/9104PK
BANDA-ALT	AX67

1993

BANDA-VENT	2/9104PK
BANDA-ALT	AX67

OM 447 LA

1998

BANDA-VENT	2/9104PK
BANDA-ALT	BX66

1992

BANDA-VENT	2/9104PK
BANDA-ALT-BA	AX67

BANDA-ALT 2

	PQ17510
--	---------

OM 355 LA

1991

BANDA-VENT	2/9100PK
BANDA-BA	9690
BANDA-ALT	PQ17490
BANDA-ALT	PQ17510

BOXER

MB 904

2010

BANDA-TOMA DE FUERZA-ALT-VENT	K080590
MANGUERA-SILICÓN AGUA	SIH1750200HH
MANGUERA-SILICÓN	SIH1000100HH
MANGUERA-CODO SILICÓN	SIH300064C45



MASTER SERVICIO PESADO 2014

MERCEDES BENZ

BOXER

MANGUERA-CODO SILICÓN	SIH400125C90	MANGUERA-SILICÓN	SIH1000100HH
TENSOR-ALT	T38460	MANGUERA-CODO SILICÓN	SIH300064C45
TAPÓN DE RADIADOR-	31348	MANGUERA-CODO SILICÓN	SIH400125C90
TERMOSTATO-	33968	TENSOR-ALT	T38460
2009		TAPÓN DE RADIADOR-	31348
BANDA-TOMA DE FUERZA-ALT-VENT	K080590	TERMOSTATO-	33968
MANGUERA-SILICÓN AGUA	SIH1750200HH	BUSS 320	
MANGUERA-SILICÓN	SIH1000100HH	BUSS 320	
MANGUERA-CODO SILICÓN	SIH300064C45	2006	
MANGUERA-CODO SILICÓN	SIH400125C90	BANDA-COMPRESOR	2/B83
TENSOR-ALT	T38460	BANDA-ALT-COMPRESOR	AX42
TAPÓN DE RADIADOR-	31348	BANDA-ALT-BA-TEMPLADOR	K080560
TERMOSTATO-	33968	2005	
2008		BANDA-COMPRESOR	2/B83
BANDA-TOMA DE FUERZA-ALT-VENT	K080590	BANDA-ALT-COMPRESOR	AX42
MANGUERA-SILICÓN AGUA	SIH1750200HH	BANDA-ALT-BA-TEMPLADOR	K080560
MANGUERA-SILICÓN	SIH1000100HH	2004	
MANGUERA-CODO SILICÓN	SIH300064C45	BANDA-COMPRESOR	2/B83
MANGUERA-CODO SILICÓN	SIH400125C90	BANDA-ALT-COMPRESOR	AX42
TENSOR-ALT	T38460	BANDA-ALT-BA-TEMPLADOR	K080560
TAPÓN DE RADIADOR-	31348	2003	
TERMOSTATO-	33968	BANDA-COMPRESOR	2/B83
2007		BANDA-ALT-COMPRESOR	AX42
BANDA-TOMA DE FUERZA-ALT-VENT	K080590	BANDA-ALT-BA-TEMPLADOR	K080560
MANGUERA-SILICÓN AGUA	SIH1750200HH	2002	
MANGUERA-SILICÓN	SIH1000100HH	BANDA-COMPRESOR	2/B83
MANGUERA-CODO SILICÓN	SIH300064C45	BANDA-ALT-COMPRESOR	AX42
MANGUERA-CODO SILICÓN	SIH400125C90	BANDA-ALT-BA-TEMPLADOR	K080560
TENSOR-ALT	T38460	BUSSCAR	
TAPÓN DE RADIADOR-	31348	MB 906	
TERMOSTATO-	33968	2008	
2006		BANDA-VENT	AX68
BANDA-TOMA DE FUERZA-ALT-VENT	K080590	BANDA-MOTOR	K080560
MANGUERA-SILICÓN AGUA	SIH1750200HH	BANDA-COMPRESOR	BX93
MANGUERA-SILICÓN	SIH1000100HH	BANDA-ALT-COMPRESOR	AX41
MANGUERA-CODO SILICÓN	SIH300064C45	BANDA-ALT (OPCIÓN 2)	PQ17460
MANGUERA-CODO SILICÓN	SIH400125C90	BANDA-ALT (OPCIÓN 1)	9463 GS
TENSOR-ALT	T38460	2007	
TAPÓN DE RADIADOR-	31348	BANDA-VENT	AX68
TERMOSTATO-	33968	BANDA-MOTOR	K080560
2005		BANDA-COMPRESOR	BX93
BANDA-TOMA DE FUERZA-ALT-VENT	K080590	BANDA-ALT-COMPRESOR	AX41
MANGUERA-SILICÓN AGUA	SIH1750200HH	BANDA-ALT (OPCIÓN 2)	PQ17460



MASTER SERVICIO PESADO 2014

MERCEDES BENZ

BUSSCAR

BANDA-ALT (OPCIÓN 1)	9463 GS	BANDA-VENT-TEMPLADOR	2/B93
2006		BANDA-COMPRESOR	5VX900
BANDA-VENT	AX68	BANDA-ALT-COMPRESOR	2/9451 PB
BANDA-MOTOR	K080560	BANDA-ALT-BA	2/9510 PB
BANDA-COMPRESOR	BX93	1999	
BANDA-ALT-COMPRESOR	AX41	BANDA-VENT-TEMPLADOR	2/B93
BANDA-ALT (OPCIÓN 2)	PQ17460	BANDA-COMPRESOR	5VX900
BANDA-ALT (OPCIÓN 1)	9463 GS	BANDA-ALT-COMPRESOR	2/9451 PB
2005		BANDA-ALT-BA	2/9510 PB
BANDA-VENT	AX68	1998	
BANDA-MOTOR	K080560	BANDA-VENT-TEMPLADOR	2/B93
BANDA-COMPRESOR	BX93	BANDA-COMPRESOR	5VX900
BANDA-ALT-COMPRESOR	AX41	BANDA-ALT-COMPRESOR	2/9451 PB
BANDA-ALT (OPCIÓN 2)	PQ17460	BANDA-ALT-BA	2/9510 PB
BANDA-ALT (OPCIÓN 1)	9463 GS	1997	
2004		BANDA-VENT-TEMPLADOR	2/B93
BANDA-VENT	AX68	BANDA-COMPRESOR	5VX900
BANDA-MOTOR	K080560	BANDA-ALT-COMPRESOR	2/9451 PB
BANDA-COMPRESOR	BX93	BANDA-ALT-BA	2/9510 PB
BANDA-ALT-COMPRESOR	AX41	CENTURY CLASS	
BANDA-ALT (OPCIÓN 2)	PQ17460	CENTURY CLASS	
BANDA-ALT (OPCIÓN 1)	9463 GS	2010	
2003		BANDA-VENT-TEMPLADOR	2/9545 PB
BANDA-VENT	AX68	BANDA-TEMPLADOR	2/9690 PB
BANDA-MOTOR	K080560	BANDA-MOTOR	K090787
BANDA-COMPRESOR	BX93	BANDA-COMPRESOR	BX90
BANDA-ALT-COMPRESOR	AX41	BANDA-ALT-COMPRESOR	AX42
BANDA-ALT (OPCIÓN 2)	PQ17460	2009	
BANDA-ALT (OPCIÓN 1)	9463 GS	BANDA-VENT-TEMPLADOR	2/9545 PB
2002		BANDA-TEMPLADOR	2/9690 PB
BANDA-VENT	AX68	BANDA-MOTOR	K090787
BANDA-MOTOR	K080560	BANDA-COMPRESOR	BX90
BANDA-COMPRESOR	BX93	BANDA-ALT-COMPRESOR	AX42
BANDA-ALT-COMPRESOR	AX41	2008	
BANDA-ALT (OPCIÓN 2)	PQ17460	BANDA-VENT-TEMPLADOR	2/9545 PB
BANDA-ALT (OPCIÓN 1)	9463 GS	BANDA-TEMPLADOR	2/9690 PB
DDA 560		BANDA-MOTOR	K090787
2001		BANDA-COMPRESOR	BX90
BANDA-VENT-TEMPLADOR	2/B93	BANDA-ALT-COMPRESOR	AX42
BANDA-COMPRESOR	5VX900	2007	
BANDA-ALT-COMPRESOR	2/9451 PB	BANDA-VENT-TEMPLADOR	2/9545 PB
BANDA-ALT-BA	2/9510 PB	BANDA-TEMPLADOR	2/9690 PB
2000		BANDA-MOTOR	K090787



MASTER SERVICIO PESADO 2014

MERCEDES BENZ

CENTURY CLASS

BANDA-COMPRESOR	BX90	BANDA-COMPRESOR	2/B90
BANDA-ALT-COMPRESOR	AX42	BANDA-ALT-COMPRESOR	2/9430 PB
2006		BANDA-ALT-BA	2/9670 PB
BANDA-VENT-TEMPLADOR	2/9545 PB	1997	
BANDA-TEMPLADOR	2/9690 PB	BANDA-VENT-TEMPLADOR	2/9570 PB
BANDA-MOTOR	K090787	BANDA-TEMPLADOR	2/9730 PB
BANDA-COMPRESOR	BX90	BANDA-COMPRESOR	2/B90
BANDA-ALT-COMPRESOR	AX42	BANDA-ALT-COMPRESOR	2/9430 PB
		BANDA-ALT-BA	2/9670 PB

MARCOPOLO

MB 457 ELECTRONICO

2003		O-500-1735	
BANDA-VENT-TEMPLADOR	2/9570 PB	2010	
BANDA-TEMPLADOR	2/9730 PB	BANDA-VENT-TEMPLADOR	2/9545 PB
BANDA-COMPRESOR	2/B90	BANDA-TEMPLADOR	2/9690 PB
BANDA-ALT-COMPRESOR	2/9430 PB	BANDA-ALT-BA-TEMPLADOR (POLEA GRANDE)	K090806
BANDA-ALT-BA	2/9670 PB	BANDA-ALT-BA-TEMPLADOR (POLEA CHICA)	K090790

MARCOPOLO ANDARE

2002		2009	
BANDA-VENT-TEMPLADOR	2/9570 PB	BANDA-VENT-TEMPLADOR	2/9545 PB
BANDA-TEMPLADOR	2/9730 PB	BANDA-TEMPLADOR	2/9690 PB
BANDA-COMPRESOR	2/B90	BANDA-ALT-BA-TEMPLADOR (POLEA GRANDE)	K090806
BANDA-ALT-COMPRESOR	2/9430 PB	BANDA-ALT-BA-TEMPLADOR (POLEA CHICA)	K090790
BANDA-ALT-BA	2/9670 PB		

2001		2008	
BANDA-VENT-TEMPLADOR	2/9570 PB	BANDA-VENT-TEMPLADOR	2/9545 PB
BANDA-TEMPLADOR	2/9730 PB	BANDA-TEMPLADOR	2/9690 PB
BANDA-COMPRESOR	2/B90	BANDA-ALT-BA-TEMPLADOR (POLEA GRANDE)	K090806
BANDA-ALT-COMPRESOR	2/9430 PB	BANDA-ALT-BA-TEMPLADOR (POLEA CHICA)	K090790
BANDA-ALT-BA	2/9670 PB		

2000		2007	
BANDA-VENT-TEMPLADOR	2/9570 PB	BANDA-VENT-TEMPLADOR	2/9545 PB
BANDA-TEMPLADOR	2/9730 PB	BANDA-TEMPLADOR	2/9690 PB
BANDA-COMPRESOR	2/B90	BANDA-ALT-BA-TEMPLADOR (POLEA GRANDE)	K090806
BANDA-ALT-COMPRESOR	2/9430 PB	BANDA-ALT-BA-TEMPLADOR (POLEA CHICA)	K090790
BANDA-ALT-BA	2/9670 PB		

1999		O-500-1728	
BANDA-VENT-TEMPLADOR	2/9570 PB	2006	
BANDA-TEMPLADOR	2/9730 PB	BANDA-VENT-TEMPLADOR	2/9545 PB
BANDA-COMPRESOR	2/B90	BANDA-TEMPLADOR	2/9660 PB
BANDA-ALT-COMPRESOR	2/9430 PB	BANDA-ALT-BA-TEMPLADOR	K080570
BANDA-ALT-BA	2/9670 PB		
		2005	
		BANDA-VENT-TEMPLADOR	2/9545 PB
		BANDA-TEMPLADOR	2/9660 PB
		BANDA-ALT-BA-TEMPLADOR	K080570

1998		MERCEDES-BENZ 960	
BANDA-VENT-TEMPLADOR	2/9570 PB	2001	
BANDA-TEMPLADOR	2/9730 PB	BANDA-VENT	A44



MASTER SERVICIO PESADO 2014

MERCEDES BENZ

MARCOPOLO ANDARE

BANDA-MOTOR	AX68	BANDA-ALT	BX68
BANDA-ALT-BA	K080585	2006	
MB 1628		BANDA-VENT	2/XPB2000
2005		BANDA-MOTOR	K090760
BANDA-VENT-TEMPLADOR	AX44	BANDA-ALT-AA	AX42
BANDA-TEMPLADOR	AX68	BANDA-ALT	BX68
BANDA-ALT-BA-TEMPLADOR	K080570	2005	
2004		BANDA-VENT	2/XPB2000
BANDA-VENT-TEMPLADOR	AX44	BANDA-MOTOR	K090760
BANDA-TEMPLADOR	AX68	BANDA-ALT-AA	AX42
BANDA-ALT-BA-TEMPLADOR	K080570	BANDA-ALT	BX68
2003		2004	
BANDA-VENT-TEMPLADOR	AX44	BANDA-VENT	2/XPB2000
BANDA-TEMPLADOR	AX68	BANDA-MOTOR	K090760
BANDA-ALT-BA-TEMPLADOR	K080570	BANDA-ALT-AA	AX42
2002		BANDA-ALT	BX68
BANDA-VENT-TEMPLADOR	AX44	2003	
BANDA-TEMPLADOR	AX68	BANDA-VENT	2/XPB2000
BANDA-ALT-BA-TEMPLADOR	K080570	BANDA-MOTOR	K090760
2001		BANDA-ALT-AA	AX42
BANDA-VENT-TEMPLADOR	AX44	BANDA-ALT	BX68
BANDA-TEMPLADOR	AX68	2002	
BANDA-ALT-BA-TEMPLADOR	K080570	BANDA-VENT	2/XPB2000
2000		BANDA-MOTOR	K090760
BANDA-VENT-TEMPLADOR	AX44	BANDA-ALT-AA	AX42
BANDA-TEMPLADOR	AX68	BANDA-ALT	BX68
BANDA-ALT-BA-TEMPLADOR	K080570	TORINO	
MULTEGO		MB 906	
MULTEGO		2010	
2009		BANDA-VENT-TEMPLADOR	AX44
BANDA-VENT	2/XPB2000	MANGUERA-TURBO RECTA	SIH890305MM7A
BANDA-MOTOR	K090760	BANDA-TEMPLADOR	AX68
BANDA-ALT-AA	AX42	BANDA-ALT-BA	K080590
BANDA-ALT	BX68	TENSOR-ALT	T38460
2008		TAPÓN DE RADIADOR-(10 LBS) SIN PALANCA	31521
BANDA-VENT	2/XPB2000	MANGUERA-	20611
BANDA-MOTOR	K090760	MANGUERA-	22702
BANDA-ALT-AA	AX42	MANGUERA-	22743
BANDA-ALT	BX68	MANGUERA-	26132
2007		2009	
BANDA-VENT	2/XPB2000	BANDA-VENT-TEMPLADOR	AX44
BANDA-MOTOR	K090760	MANGUERA-TURBO RECTA	SIH890305MM7A
BANDA-ALT-AA	AX42	BANDA-TEMPLADOR	AX68



MASTER SERVICIO PESADO 2014

MERCEDES BENZ

TORINO

BANDA-ALT-BA	K080590	BANDA-TEMPLADOR	AX68
TENSOR-ALT	T38460	BANDA-ALT-BA	K080590
TAPÓN DE RADIADOR-(10 LBS) SIN PALANCA	31521	TENSOR-ALT	T38460
MANGUERA-	20611	TAPÓN DE RADIADOR-(10 LBS) SIN PALANCA	31521
MANGUERA-	22702	MANGUERA-	20611
MANGUERA-	22743	MANGUERA-	22702
MANGUERA-	26132	MANGUERA-	22743
2008		MANGUERA-	26132
BANDA-VENT-TEMPLADOR	AX44	TURICLASS	
MANGUERA-TURBO RECTA	SIH890305MM7A	O-500-1841	
BANDA-TEMPLADOR	AX68	2010	
BANDA-ALT-BA	K080590	BANDA-MOTOR	K090787
TENSOR-ALT	T38460	BANDA-FAN CLUTCH	2/XPB2000
TAPÓN DE RADIADOR-(10 LBS) SIN PALANCA	31521	BANDA-ALT-COMPRESOR	AX42
MANGUERA-	20611	BANDA-AA	2/B83
MANGUERA-	22702	2009	
MANGUERA-	22743	BANDA-MOTOR	K090787
MANGUERA-	26132	BANDA-FAN CLUTCH	2/XPB2000
2007		BANDA-ALT-COMPRESOR	AX42
BANDA-VENT-TEMPLADOR	AX44	BANDA-AA	2/B83
MANGUERA-TURBO RECTA	SIH890305MM7A	2008	
BANDA-TEMPLADOR	AX68	BANDA-MOTOR	K090787
BANDA-ALT-BA	K080590	BANDA-FAN CLUTCH	2/XPB2000
TENSOR-ALT	T38460	BANDA-ALT-COMPRESOR	AX42
TAPÓN DE RADIADOR-(10 LBS) SIN PALANCA	31521	BANDA-AA	2/B83
MANGUERA-	20611	2007	
MANGUERA-	22702	BANDA-MOTOR	K090787
MANGUERA-	22743	BANDA-FAN CLUTCH	2/XPB2000
MANGUERA-	26132	BANDA-ALT-COMPRESOR	AX42
2006		BANDA-AA	2/B83
BANDA-VENT-TEMPLADOR	AX44	NEOPLAN	
MANGUERA-TURBO RECTA	SIH890305MM7A		
BANDA-TEMPLADOR	AX68	NEOBUS	
BANDA-ALT-BA	K080590	CUMMINS S60	
TENSOR-ALT	T38460	2006	
TAPÓN DE RADIADOR-(10 LBS) SIN PALANCA	31521	BANDA-VENT1-VENT2	BX82
MANGUERA-	20611	BANDA-MOTOR	BX97
MANGUERA-	22702	BANDA-COMPRESOR	BX94
MANGUERA-	22743	BANDA-ALT-IMPULSOR	K120735
MANGUERA-	26132	2005	
2005		BANDA-VENT1-VENT2	BX82
BANDA-VENT-TEMPLADOR	AX44		
MANGUERA-TURBO RECTA	SIH890305MM7A		



MASTER SERVICIO PESADO 2014

NEOPLAN

NEOBUS

BANDA-MOTOR	BX97	BANDA-COMPRESOR	BX97
BANDA-COMPRESOR	BX94	BANDA-ALT-IMPULSOR	K120720
BANDA-ALT-IMPULSOR	K120735	1997	
2004		BANDA-VENT1-VENT2	BX80
BANDA-VENT1-VENT2	BX82	BANDA-MOTOR	BX76
BANDA-MOTOR	BX97	BANDA-COMPRESOR	BX97
BANDA-COMPRESOR	BX94	BANDA-ALT-IMPULSOR	K120720
BANDA-ALT-IMPULSOR	K120735	1996	
2003		BANDA-VENT1-VENT2	BX80
BANDA-VENT1-VENT2	BX82	BANDA-MOTOR	BX76
BANDA-MOTOR	BX97	BANDA-COMPRESOR	BX97
BANDA-COMPRESOR	BX94	BANDA-ALT-IMPULSOR	K120720
BANDA-ALT-IMPULSOR	K120735	1995	
2002		BANDA-VENT1-VENT2	BX80
BANDA-VENT1-VENT2	BX82	BANDA-MOTOR	BX76
BANDA-MOTOR	BX97	BANDA-COMPRESOR	BX97
BANDA-COMPRESOR	BX94	BANDA-ALT-IMPULSOR	K120720
BANDA-ALT-IMPULSOR	K120735	1994	
2001		BANDA-VENT1-VENT2	BX80
BANDA-VENT1-VENT2	BX82	BANDA-MOTOR	BX76
BANDA-MOTOR	BX97	BANDA-COMPRESOR	BX97
BANDA-COMPRESOR	BX94	BANDA-ALT-IMPULSOR	K120720
BANDA-ALT-IMPULSOR	K120735	1993	
2000		BANDA-VENT1-VENT2	BX80
BANDA-VENT1-VENT2	BX82	BANDA-MOTOR	BX76
BANDA-MOTOR	BX97	BANDA-COMPRESOR	BX97
BANDA-COMPRESOR	BX94	BANDA-ALT-IMPULSOR	K120720
BANDA-ALT-IMPULSOR	K120735	1992	
NEOPLAN 2 PISOS		BANDA-VENT1-VENT2	BX80
CUMMINS S60		BANDA-MOTOR	BX76
2000		BANDA-COMPRESOR	BX97
BANDA-VENT1-VENT2	BX80	BANDA-ALT-IMPULSOR	K120720
BANDA-TOMA DE FUERZA	BX76		
BANDA-COMPRESOR	BX97		
BANDA-ALT-IMPULSOR	K120720		
1999			
BANDA-VENT1-VENT2	BX80		
BANDA-MOTOR	BX76		
BANDA-COMPRESOR	BX97		
BANDA-ALT-IMPULSOR	K120720		
1998			
BANDA-VENT1-VENT2	BX80		
BANDA-MOTOR	BX76		
		NISSAN	
			
		CABSTAR	
		NISSAN DIESEL YD25DDTi	
		2013	
		BANDA-DH	K040325
		BANDA-ALT-VENT	K070505
		TAPÓN DE RADIADOR-(13 LBS) SIN PALANCA	31333
		2012	
		BANDA-DH	K040325



MASTER SERVICIO PESADO 2014

NISSAN

CABSTAR

BANDA-ALT-VENT	K070505	BANDA-VENT	PQ17540
TAPÓN DE RADIADOR-(13 LBS) SIN PALANCA	31333	BANDA-ALT 2	PQ17440
2011		BANDA-ALT 1	AX72
BANDA-DH	K040325	BANDA-AA	BX90
BANDA-ALT-VENT	K070505	1998	
TAPÓN DE RADIADOR-(13 LBS) SIN PALANCA	31333	BANDA-VENT	PQ17540
2010		BANDA-ALT 2	PQ17440
BANDA-DH	K040325	BANDA-ALT 1	AX72
BANDA-ALT-VENT	K070505	BANDA-AA	BX90
TAPÓN DE RADIADOR-(13 LBS) SIN PALANCA	31333	1997	
2009		BANDA-VENT	PQ17540
BANDA-DH	K040325	BANDA-ALT 2	PQ17440
BANDA-ALT-VENT	K070505	BANDA-ALT 1	AX72
TAPÓN DE RADIADOR-(13 LBS) SIN PALANCA	31333	BANDA-AA	BX90
2008		1996	
BANDA-DH	K040325	BANDA-VENT	PQ17540
BANDA-ALT-VENT	K070505	BANDA-ALT 2	PQ17440
TAPÓN DE RADIADOR-(13 LBS) SIN PALANCA	31333	BANDA-ALT 1	AX72

SCANIA



IRIZAR 15

K420		BANDA-AA	BX90
2013		1994	
BANDA-	BX87	BANDA-VENT	PQ17540
BANDA-	K080970	BANDA-ALT 2	PQ17440
2012		BANDA-ALT 1	AX72
BANDA-	BX87	BANDA-AA	BX90
BANDA-	K080970		

IRIZAR 16

K420		DSC11-22	
2013		1998	
BANDA-	BX87	BANDA-VENT	8594 GS
BANDA-	K080970	BANDA-ALT	AX72
		BANDA-ALT	PQ17450
		BANDA-AA	BX93

SCANIA

K113		1997	
2000		BANDA-VENT	8594 GS
BANDA-VENT	PQ17540	BANDA-ALT	AX72
BANDA-ALT 2	PQ17440	BANDA-ALT	PQ17450
BANDA-ALT 1	AX72	BANDA-AA	BX93
BANDA-AA	BX90	1996	
1999		BANDA-VENT	8594 GS
		BANDA-ALT	AX72



MASTER SERVICIO PESADO 2014

SCANIA

SCANIA

BANDA-ALT	PQ17450
BANDA-AA	BX93
1995	
BANDA-VENT	8594 GS
BANDA-ALT	AX72
BANDA-ALT	PQ17450
BANDA-AA	BX93
1994	
BANDA-VENT	8594 GS
BANDA-ALT	AX72
BANDA-ALT	PQ17450
BANDA-AA	BX93
1993	
BANDA-VENT	8594 GS
BANDA-ALT	AX72
BANDA-ALT	PQ17450
BANDA-AA	BX93
1992	
BANDA-VENT	8594 GS
BANDA-ALT	AX72
BANDA-ALT	PQ17450
BANDA-AA	BX93
1991	
BANDA-VENT	8594 GS
BANDA-ALT	AX72
BANDA-ALT	PQ17450
BANDA-AA	BX93

BANDA-AA	BX94
1995	
BANDA-BA	AX72
BANDA-ALT	PQ17450
BANDA-AA	BX94
1994	
BANDA-BA	AX72
BANDA-ALT	PQ17450
BANDA-AA	BX94
1993	
BANDA-BA	AX72
BANDA-ALT	PQ17450
BANDA-AA	BX94
1992	
BANDA-BA	AX72
BANDA-ALT	PQ17450
BANDA-AA	BX94

SCANIA PARADISO

K112	
2000	
BANDA-BA	AX72
BANDA-ALT	PQ17450
BANDA-AA	BX94
1999	
BANDA-BA	AX72
BANDA-ALT	PQ17450
BANDA-AA	BX94
1998	
BANDA-BA	AX72
BANDA-ALT	PQ17450
BANDA-AA	BX94
1997	
BANDA-BA	AX72
BANDA-ALT	PQ17450
BANDA-AA	BX94
1996	
BANDA-BA	AX72
BANDA-ALT	PQ17450

STERLING



360

MITSUBISHI FUSO 4M50 DIESEL

2013	
MANGUERA SUPERIOR-MOTOR A RAD.	20957
BANDA-	K060480
2012	
MANGUERA SUPERIOR-MOTOR A RAD.	20957
BANDA-	K060480
2011	
MANGUERA SUPERIOR-MOTOR A RAD.	20957
BANDA-	K060480
2010	
MANGUERA SUPERIOR-MOTOR A RAD.	20957
BANDA-	K060480
2009	
MANGUERA SUPERIOR-MOTOR A RAD.	20957
BANDA-	K060480
2008	
MANGUERA SUPERIOR-MOTOR A RAD.	20957
BANDA-	K060480
2007	
MANGUERA SUPERIOR-MOTOR A RAD.	20957
BANDA-ALT-AA	K060480



2006	
MANGUERA SUPERIOR-MOTOR A RAD.	20957
BANDA-ALT-AA	K060480

ACTERRA

MERCEDES-BENZ MBE 900 DIESEL

2007	
BANDA-TOMA DE FUERZA-ALT-VENT-AA	K080825
MANGUERA INFERIOR-RAD. A ENFRIADOR	20206
MANGUERA INFERIOR-MOTOR A TUBO	21559
TENSOR-MOTOR	38567

2006	
BANDA-TOMA DE FUERZA-ALT-VENT-AA	K080825
MANGUERA SILICÓN-RAD. A TUBO	SIH200363C
MANGUERA SUPERIOR-MOTOR A RAD.	21378
TENSOR-MOTOR	38567

2005	
MANGUERA SILICÓN-TUBO A ENFRIADOR	SIH200363C
BANDA-TOMA DE FUERZA-ALT-VENT-AA	K080830
MANGUERA INFERIOR-MOTOR A TUBO	21571
MANGUERA SUPERIOR-MOTOR A RAD.	21378
TENSOR-MOTOR	38567
MANGUERA INFERIOR-ENFRIADOR A TUBO	20611

2004	
MANGUERA INFERIOR-TUBO A RAD.	21135
MANGUERA INFERIOR-TUBO A RAD.	22903
MANGUERA SUPERIOR-TUBO A RAD.	21135
BANDA-TOMA DE FUERZA-ALT-VENT-AA	K080810
BANDA-TOMA DE FUERZA-ALT-VENT-AA	K080830
MANGUERA INFERIOR-MOTOR A TUBO	21571
MANGUERA SUPERIOR-MOTOR A TUBO	22701
TENSOR-MOTOR	38567
TENSOR-	38567

2003	
MANGUERA INFERIOR-TUBOO A RAD.	22903
MANGUERA INFERIOR-TUBO A RAD.	21135
MANGUERA INFERIOR-TUBO A RAD.	22903
MANGUERA SUPERIOR-TUBO A RAD.	21135
BANDA-TOMA DE FUERZA-ALT-VENT-AA	K080830
MANGUERA INFERIOR-MOTOR A TUBO	21571
MANGUERA SUPERIOR-MOTOR A TUBO	22701
TENSOR-MOTOR	38567
TENSOR-	38567

2002	
-------------	--

MANGUERA INFERIOR-TUBOO A RAD.	22903
MANGUERA INFERIOR-TUBO A RAD.	21135
MANGUERA INFERIOR-TUBO A RAD.	22903
MANGUERA SUPERIOR-TUBO A RAD.	21135
BANDA-TOMA DE FUERZA-ALT-VENT-AA	K080830
MANGUERA INFERIOR-MOTOR A TUBO	21571
MANGUERA SUPERIOR-MOTOR A TUBO	22701
MANGUERA SUPERIOR-MOTOR A RAD.	21571
TENSOR-MOTOR	38567
TENSOR-	38567

2001	
MANGUERA INFERIOR-TUBOO A RAD.	22903
MANGUERA INFERIOR-TUBO A RAD.	21135
MANGUERA INFERIOR-TUBO A RAD.	22903
MANGUERA SUPERIOR-TUBO A RAD.	21135
BANDA-TOMA DE FUERZA-ALT-VENT-AA	K080830
MANGUERA INFERIOR-MOTOR A TUBO	21571
MANGUERA SUPERIOR-MOTOR A TUBO	22701
MANGUERA SUPERIOR-MOTOR A RAD.	21571
TENSOR-MOTOR	38567
TENSOR-	38567

DETROIT DIESEL SERIES 55 DIESEL

2001	
TERMOSTATO-190°	33599

CUMMINS N14 DIESEL

2001	
TERMOSTATO-190°	33579
TERMOSTATO-180°	33576
TERMOSTATO-180°	33578
TERMOSTATO-170°	33577

CUMMINS ISC DIESEL

2008	
MANGUERA SILICÓN-RAD. A TUBO	SIH200363C
MANGUERA INFERIOR-MOTOR A TUBO	24436
MANGUERA SUPERIOR-MOTOR A TUBO	24436
BANDA-ALT-BA-VENT-AA	K080820
POLEA DEL TENSOR-ALT-BA-VENT	36093
TENSOR-ALT-BA-VENT	38516
TERMOSTATO-180°-C/DOBLE TERMOSTATO	33966
TERMOSTATO-180°	33959
2007	
BANDA-VENT-AA	9480
MANGUERA INFERIOR-RAD. A TUBO	20206



MASTER SERVICIO PESADO 2014

STERLING

ACTERRA

BANDA-ALT-BA-VENT-AA	K080820	BANDA-ALT-VENT-AA	K080816
BANDA-ALT-BA-VENT	K080708	TERMOSTATO-190°	33915
POLEA DEL TENSOR-ALT-BA-VENT	36093	TERMOSTATO-180°	33956
TENSOR-ALT-BA-VENT	38516	CUMMINS ISB DIESEL	
TERMOSTATO-180°-C/DOBLE TERMOSTATO	33966	2003	
TERMOSTATO-180°	33959	TERMOSTATO-190°	33915
2006		TERMOSTATO-180°	33956
BANDA-VENT-AA	9480	2002	
MANGUERA INFERIOR-RAD. A TUBO	20206	TERMOSTATO-190°	33915
BANDA-ALT-BA-VENT-AA	K080820	TERMOSTATO-180°	33956
BANDA-ALT-BA-VENT	K080708	2001	
POLEA DEL TENSOR-ALT-BA-VENT	36093	TERMOSTATO-190°	33915
TENSOR-ALT-BA-VENT	38516	TERMOSTATO-180°	33956
TERMOSTATO-180°-C/DOBLE TERMOSTATO	33966	CATERPILLAR C9 DIESEL	
TERMOSTATO-180°	33959	2006	
2005		TERMOSTATO-190°	33579
BANDA-VENT-AA	9480	TERMOSTATO-180°	33576
MANGUERA INFERIOR-RAD. A TUBO	20206	TERMOSTATO-180°	33578
MANGUERA SUPERIOR-RAD. A TUBO	21571	TERMOSTATO-170°	33577
MANGUERA INFERIOR-MOTOR A TUBO	20206	CATERPILLAR C7 DIESEL	
MANGUERA SUPERIOR-MOTOR A TUBO	24436	2008	
BANDA-ALT-BA-VENT-AA	K080820	TERMOSTATO-190°	33969
BANDA-ALT-BA-VENT	K080708	TERMOSTATO-180°	33968
POLEA DEL TENSOR-ALT-BA-VENT	36093	2007	
TENSOR-ALT-BA-VENT	38516	MANGUERA INFERIOR-RAD. A TUBO	20206
TERMOSTATO-180°-C/DOBLE TERMOSTATO	33966	MANGUERA SILICÓN-RAD. A TUBO	SIH200363C
TERMOSTATO-180°	33959	MANGUERA INFERIOR-MOTOR A TUBO	20206
2004		MANGUERA SUPERIOR-MOTOR A TUBO	20206
TERMOSTATO-180°-C/DOBLE TERMOSTATO	33966	POLEA-MOTOR	36091
TERMOSTATO-180°	33959	BANDA-BA	8345 GS
2003		BANDA-ALT-VENT-AA	K080694
TERMOSTATO-180°-C/DOBLE TERMOSTATO	33966	TERMOSTATO-190°	33969
TERMOSTATO-180°	33959	TERMOSTATO-180°	33968
2002		POLEA-	36096
TERMOSTATO-180°-C/DOBLE TERMOSTATO	33966	2006	
TERMOSTATO-180°	33959	MANGUERA INFERIOR-RAD. A TUBO	20206
2001		MANGUERA SILICÓN-RAD. A TUBO	SIH200363C
TERMOSTATO-180°-C/DOBLE TERMOSTATO	33966	MANGUERA INFERIOR-MOTOR A TUBO	20206
TERMOSTATO-180°	33959	MANGUERA SUPERIOR-MOTOR A TUBO	20206
CUMMINS ISB-07 DIESEL		POLEA-MOTOR	36091
2008		BANDA-BA	9341
MANGUERA SILICÓN-RAD. A TUBO	SIH200363C	BANDA-ALT-VENT-AA	K080694
MANGUERA SILICÓN-MOTOR A TUBO	SIH200363C	TERMOSTATO-190°	33969



TERMOSTATO-180°	33968	POLEA-MOTOR	36093
POLEA-	36096	BANDA-ALT-VENT-AA	K081005
2005		TERMOSTATO-190°	33579
MANGUERA INFERIOR-RAD. A TUBO	20206	TERMOSTATO-180°	33576
MANGUERA INFERIOR-MOTOR A TUBO	20206	TERMOSTATO-180°	33578
MANGUERA SUPERIOR-MOTOR A RAD.	22668	TERMOSTATO-175°	33549
POLEA-MOTOR	36091	TERMOSTATO-170°	33577
BANDA-BA	9341	CATERPILLAR 3126 DIESEL	
BANDA-ALT-VENT-AA	K080734	2004	
TERMOSTATO-190°	33969	MANGUERA SILICÓN-TUBO A RAD.	SIH200363C
TERMOSTATO-180°	33968	MANGUERA SILICÓN-TUBO A RAD.	SIH250363C
POLEA-	36096	MANGUERA INFERIOR-MOTOR A TUBO	21135
2004		MANGUERA SILICÓN-MOTOR A TUBO	SIH200363C
MANGUERA INFERIOR-RAD. A TUBO	21891	BANDA-BA	9341
MANGUERA INFERIOR-MOTOR A TUBO	21891	BANDA-ALT-VENT-AA	K080702
MANGUERA SUPERIOR-MOTOR A RAD.	22668	BANDA-ALT-VENT-AA	K080780
POLEA-MOTOR	36091	TENSOR-ALT-VENT-AA	38511
BANDA-BA	8345 GS	POLEA DEL TENSOR-ALT-BA-VENT	36091
BANDA-BA	9341	TERMOSTATO-190°	33969
BANDA-ALT-VENT-AA	K080702	TERMOSTATO-180°	33968
TENSOR-ALT-VENT-AA	38511	POLEA-	36096
BANDA-ALT-BA-VENT	K080702	2003	
TERMOSTATO-190°	33969	MANGUERA INFERIOR-TUBO A RAD.	24440
TERMOSTATO-180°	33968	MANGUERA INFERIOR-TUBO A RAD.	24432
POLEA-	36096	MANGUERA SILICÓN-TUBO A RAD.	SIH200363C
CATERPILLAR C13 DIESEL		MANGUERA SILICÓN-TUBO A RAD.	SIH250363C
2006		MANGUERA INFERIOR-MOTOR A TUBO	21135
MANGUERA INFERIOR-MOTOR A RAD.	22952	MANGUERA SILICÓN-MOTOR A TUBO	SIH200363C
MANGUERA SUPERIOR-MOTOR A RAD.	22980	MANGUERA SUPERIOR-MOTOR A TUBO	24432
POLEA-MOTOR	36093	BANDA-BA	8345 GS
BANDA-ALT-VENT-AA	K081005	BANDA-BA	9341
TENSOR-ALT-VENT-AA	38590	BANDA-ALT-VENT-AA	K080702
BANDA-ALT-VENT	K080926	BANDA-ALT-VENT-AA	K080780
TENSOR-ALT-VENT	38590	POLEA-ALT-VENT-AA	36091
TERMOSTATO-190°	33579	TENSOR-ALT-VENT-AA	38511
TERMOSTATO-180°	33576	BANDA-ALT-BA-VENT	K080702
TERMOSTATO-180°	33578	POLEA DEL TENSOR-ALT-BA-VENT	36091
TERMOSTATO-170°	33577	TERMOSTATO-190°	33969
2004		TERMOSTATO-180°	33968
MANGUERA INFERIOR-RAD. A TUBO	21891	POLEA-	36096
MANGUERA INFERIOR-MOTOR A TUBO	24440	2002	
MANGUERA SILICÓN-MOTOR A TUBO	SIH250363C	MANGUERA SILICÓN-TUBO A RAD.	SIH200363C
MANGUERA SUPERIOR-MOTOR A RAD.	22980	MANGUERA SILICÓN-TUBO A RAD.	SIH250363C



MASTER SERVICIO PESADO 2014

STERLING

ACTERRA

MANGUERA INFERIOR-MOTOR A TUBO	21135	TENSOR-TOMA DE FUERZA-ALT-AA	38501
MANGUERA SILICÓN-MOTOR A TUBO	SIH200363C	MANGUERA INFERIOR-MOTOR A TUBO	21891
BANDA-BA	9341	MANGUERA SUPERIOR-MOTOR A RAD.	22850
BANDA-ALT-VENT-AA	K080702	2004	
BANDA-ALT-VENT-AA	K080780	BANDA-VENT	K080545
TENSOR-ALT-VENT-AA	38511	TENSOR-VENT	38597
POLEA DEL TENSOR-ALT-BA-VENT	36091	MANGUERA SILICÓN-TUBO A RAD.	SIH250363C
TERMOSTATO-190°	33969	BANDA-TOMA DE FUERZA-ALT-AA	K080855
TERMOSTATO-180°	33968	POLEA DEL TENSOR-TOMA DE FUERZA-ALT-AA	38075
POLEA-	36096	TENSOR-TOMA DE FUERZA-ALT-AA	38501
2001		MANGUERA INFERIOR-MOTOR A TUBO	21891
MANGUERA SILICÓN-TUBO A RAD.	SIH200363C	MANGUERA SUPERIOR-MOTOR A RAD.	22850
MANGUERA SILICÓN-TUBO A RAD.	SIH250363C	DETROIT DIESEL SERIE 60	
MANGUERA INFERIOR-MOTOR A TUBO	21135	2006	
MANGUERA SILICÓN-MOTOR A TUBO	SIH200363C	BANDA-VENT	K100579
BANDA-BA	9341	POLEA-VENT	38076
BANDA-ALT-VENT-AA	K080702	TENSOR-VENT	38503
BANDA-ALT-VENT-AA	K080780	BANDA-TOMA DE FUERZA-ALT-AA	K080565
TENSOR-ALT-VENT-AA	38511	POLEA-TOMA DE FUERZA-ALT-AA	38075
POLEA DEL TENSOR-ALT-BA-VENT	36091	TENSOR-TOMA DE FUERZA-ALT-AA	38501
TERMOSTATO-190°	33969	MANGUERA INFERIOR-RAD. A TUBO	20748
TERMOSTATO-180°	33968	MANGUERA SUPERIOR-RAD. A TUBO	21115
POLEA-	36096	MANGUERA INFERIOR-MOTOR A TUBO	24436
A-LINE		MANGUERA SUPERIOR-MOTOR A TUBO	24440
MERCEDES-BENZ MBE 4000 DIESEL		2005	
2008		BANDA-VENT	K100579
BANDA-VENT	K080505	POLEA-VENT	38076
TENSOR-VENT	38597	TENSOR-VENT	38503
TENSOR-MOTOR	38501	BANDA-TOMA DE FUERZA-ALT-AA	K080565
BANDA-ALT-BA-AA	K080855	POLEA-TOMA DE FUERZA-ALT-AA	38075
2006		TENSOR-TOMA DE FUERZA-ALT-AA	38501
BANDA-VENT	K080545	MANGUERA INFERIOR-RAD. A TUBO	20748
TENSOR-VENT	38597	MANGUERA SUPERIOR-RAD. A TUBO	21115
BANDA-TOMA DE FUERZA-ALT-AA	K080855	MANGUERA INFERIOR-MOTOR A TUBO	24436
POLEA DEL TENSOR-TOMA DE FUERZA-ALT-AA	38075	MANGUERA SUPERIOR-MOTOR A TUBO	24440
TENSOR-TOMA DE FUERZA-ALT-AA	38501	2004	
MANGUERA INFERIOR-MOTOR A RAD.	23014	BANDA-VENT	K100579
2005		POLEA-VENT	38076
BANDA-VENT	K080545	TENSOR-VENT	38503
TENSOR-VENT	38597	BANDA-TOMA DE FUERZA-ALT-AA	K080545
MANGUERA SILICÓN-TUBO A RAD.	SIH250363C	POLEA-TOMA DE FUERZA-ALT-AA	38075
BANDA-TOMA DE FUERZA-ALT-AA	K080855	TENSOR-TOMA DE FUERZA-ALT-AA	38501
POLEA DEL TENSOR-TOMA DE FUERZA-ALT-AA	38075	MANGUERA SUPERIOR-MOTOR A TUBO	21891



2002			
BANDA-VENT	K140496	BANDA-VENT	K100579
MANGUERA INFERIOR-TUBOO A RAD.	24440	POLEA DEL TENSOR-VENT	38076
MANGUERA SUPERIOR-TUBO A RAD.	21891	TENSOR-VENT	38503
BANDA-TOMA DE FUERZA-ALT-AA	K080565	BANDA-TOMA DE FUERZA-ALT-AA	K080545
TENSOR-TOMA DE FUERZA-ALT-AA	38501	POLEA DEL TENSOR-TOMA DE FUERZA-ALT-AA	38075
MANGUERA INFERIOR-MOTOR A TUBO	21891	TENSOR-TOMA DE FUERZA-ALT-AA	38501
MANGUERA SUPERIOR-MOTOR A TUBO	24440	MANGUERA SUPERIOR-MOTOR A TUBO	21891
		TERMOSTATO-190°	33599
		MANGUERA SILICÓN-	SIH250363C
2001		2003	
BANDA-VENT	K140496	TERMOSTATO-190°	33599
MANGUERA INFERIOR-TUBOO A RAD.	24440		
MANGUERA SUPERIOR-TUBO A RAD.	24440	DETROIT DIESEL 6 CIL, 12.7 L DIESEL	
BANDA-TOMA DE FUERZA-ALT	K060420	2007	
POLEA-TOMA DE FUERZA-ALT	38075	TERMOSTATO-190°	33599
TENSOR-TOMA DE FUERZA-ALT	38502	2006	
BANDA-TOMA DE FUERZA-AA	8371 GS	BANDA-VENT	K100579
MANGUERA INFERIOR-MOTOR A TUBO	24440	POLEA DEL TENSOR-VENT	38076
		TENSOR-VENT	38503
DETROIT DIESEL 6 CIL, 14.0 L DIESEL		BANDA-TOMA DE FUERZA-ALT-AA	K080565
2007		POLEA DEL TENSOR-TOMA DE FUERZA-ALT-AA	38075
TERMOSTATO-190°	33599	TENSOR-TOMA DE FUERZA-ALT-AA	38501
2006		MANGUERA INFERIOR-RAD. A TUBO	21135
BANDA-VENT	K100579	MANGUERA SUPERIOR-RAD. A TUBO	21115
POLEA DEL TENSOR-VENT	38076	MANGUERA INFERIOR-MOTOR A TUBO	24436
TENSOR-VENT	38503	MANGUERA SILICÓN-MOTOR A TUBO	SIH250363C
BANDA-TOMA DE FUERZA-ALT-AA	K080565	TERMOSTATO-190°	33599
POLEA DEL TENSOR-TOMA DE FUERZA-ALT-AA	38075	2005	
TENSOR-TOMA DE FUERZA-ALT-AA	38501	BANDA-VENT	K100579
MANGUERA INFERIOR-RAD. A TUBO	21135	POLEA DEL TENSOR-VENT	38076
MANGUERA SUPERIOR-RAD. A TUBO	21115	TENSOR-VENT	38503
MANGUERA INFERIOR-MOTOR A TUBO	24436	BANDA-TOMA DE FUERZA-ALT-AA	K080565
MANGUERA SILICÓN-MOTOR A TUBO	SIH250363C	POLEA DEL TENSOR-TOMA DE FUERZA-ALT-AA	38075
TERMOSTATO-190°	33599	TENSOR-TOMA DE FUERZA-ALT-AA	38501
2005		MANGUERA SILICÓN-RAD. A TUBO	SIH250363C
BANDA-VENT	K100579	MANGUERA SILICÓN-MOTOR A TUBO	SIH250363C
POLEA DEL TENSOR-VENT	38076	TERMOSTATO-190°	33599
TENSOR-VENT	38503	2004	
BANDA-TOMA DE FUERZA-ALT-AA	K080565	BANDA-VENT	K100579
POLEA DEL TENSOR-TOMA DE FUERZA-ALT-AA	38075	POLEA DEL TENSOR-VENT	38076
TENSOR-TOMA DE FUERZA-ALT-AA	38501	TENSOR-VENT	38503
MANGUERA SILICÓN-RAD. A TUBO	SIH250363C	BANDA-TOMA DE FUERZA-ALT-AA	K080545
MANGUERA SILICÓN-MOTOR A TUBO	SIH250363C	POLEA DEL TENSOR-TOMA DE FUERZA-ALT-AA	38075
TERMOSTATO-190°	33599	TENSOR-TOMA DE FUERZA-ALT-AA	38501
2004			



MASTER SERVICIO PESADO 2014

STERLING

A-LINE

MANGUERA SUPERIOR-MOTOR A TUBO	21891	BANDA-VENT	K140496
TERMOSTATO-190°	33599	MANGUERA SILICÓN-TUBO A RAD.	SIH250363C
MANGUERA SILICÓN-	SIH250363C	BANDA-TOMA DE FUERZA-ALT-AA	K080565
2003		POLEA DEL TENSOR-TOMA DE FUERZA-ALT-AA	38075
TERMOSTATO-190°	33599	TENSOR-TOMA DE FUERZA-ALT-AA	38501
2002		MANGUERA SILICÓN-MOTOR A TUBO	SIH250363C
BANDA-VENT	K140496	TERMOSTATO-190°	33599
MANGUERA SILICÓN-TUBO A RAD.	SIH250363C	2000	
MANGUERA SUPERIOR-TUBO A RAD.	21891	BANDA-VENT	K140496
BANDA-TOMA DE FUERZA-ALT-AA	K080565	MANGUERA SILICÓN-TUBO A RAD.	SIH250363C
TENSOR-TOMA DE FUERZA-ALT-AA	38501	BANDA-TOMA DE FUERZA-ALT	2/9485FPB
MANGUERA INFERIOR-MOTOR A TUBO	21891	BANDA-TOMA DE FUERZA-ALT	K060420
MANGUERA SILICÓN-MOTOR A TUBO	SIH250363C	POLEA-TOMA DE FUERZA-ALT	38075
TERMOSTATO-190°	33599	TENSOR-TOMA DE FUERZA-ALT	38502
2001		BANDA-TOMA DE FUERZA-AA	9370
BANDA-VENT	K140496	MANGUERA SILICÓN-MOTOR A TUBO	SIH250363C
MANGUERA SILICÓN-TUBO A RAD.	SIH250363C	TERMOSTATO-190°	33599
BANDA-TOMA DE FUERZA-ALT-AA	K080565	CUMMINS N14 DIESEL	
POLEA DEL TENSOR-TOMA DE FUERZA-ALT-AA	38075	2003	
TENSOR-TOMA DE FUERZA-ALT-AA	38501	MANGUERA SILICÓN-TUBO A RAD.	SIH250363C
MANGUERA SILICÓN-MOTOR A TUBO	SIH250363C	MANGUERA SUPERIOR-TUBO A RAD.	21135
TERMOSTATO-190°	33599	BANDA-TOMA DE FUERZA-BA	K060415
2000		BANDA-TOMA DE FUERZA-AA	9420
BANDA-VENT	K140496	MANGUERA SILICÓN-MOTOR A TUBO	SIH250363C
MANGUERA SILICÓN-TUBO A RAD.	SIH250363C	BANDA-ALT	9435
BANDA-TOMA DE FUERZA-ALT	2/9485FPB	TERMOSTATO-190°	33579
BANDA-TOMA DE FUERZA-ALT	K060420	TERMOSTATO-180°	33576
POLEA-TOMA DE FUERZA-ALT	38075	TERMOSTATO-180°	33578
TENSOR-TOMA DE FUERZA-ALT	38502	TERMOSTATO-170°	33577
BANDA-TOMA DE FUERZA-AA	9370	2002	
MANGUERA SILICÓN-MOTOR A TUBO	SIH250363C	MANGUERA INFERIOR-TUBO A RAD.	24440
TERMOSTATO-190°	33599	MANGUERA INFERIOR-TUBO A RAD.	21135
DETROIT DIESEL 6 CIL, 11.1 L DIESEL		MANGUERA SILICÓN-TUBO A RAD.	SIH250363C
2002		MANGUERA SUPERIOR-TUBO A RAD.	21135
BANDA-VENT	K140496	BANDA-TOMA DE FUERZA-BA	K060415
MANGUERA SILICÓN-TUBO A RAD.	SIH250363C	BANDA-TOMA DE FUERZA-AA	9420
MANGUERA SUPERIOR-TUBO A RAD.	21891	BANDA-TOMA DE FUERZA-AA	PQ17420
BANDA-TOMA DE FUERZA-ALT-AA	K080565	MANGUERA INFERIOR-MOTOR A TUBO	24440
TENSOR-TOMA DE FUERZA-ALT-AA	38501	MANGUERA SILICÓN-MOTOR A TUBO	SIH250363C
MANGUERA INFERIOR-MOTOR A TUBO	21891	MANGUERA SUPERIOR-MOTOR A TUBO	24440
MANGUERA SILICÓN-MOTOR A TUBO	SIH250363C	BANDA-ALT	8435 GS
TERMOSTATO-190°	33599	BANDA-ALT	9435
2001		TERMOSTATO-190°	33579



TERMOSTATO-180°	33576	2000	
TERMOSTATO-180°	33578	BANDA-VENT	K140516
TERMOSTATO-170°	33577	MANGUERA SILICÓN-TUBO A RAD.	SIH250363C
2001		BANDA-TOMA DE FUERZA-ALT	K050360
MANGUERA INFERIOR-TUBOO A RAD.	24440	BANDA-TOMA DE FUERZA-AA	9480
MANGUERA INFERIOR-TUBO A RAD.	21135	MANGUERA SILICÓN-MOTOR A TUBO	SIH200363C
MANGUERA SILICÓN-TUBO A RAD.	SIH250363C	MANGUERA SILICÓN-MOTOR A TUBO	SIH250363C
MANGUERA SUPERIOR-TUBO A RAD.	21135	MANGUERA SILICÓN-MOTOR A RAD.	SIH250363C
BANDA-TOMA DE FUERZA-VENT	K140429	CATERPILLAR C9 DIESEL	
BANDA-TOMA DE FUERZA-BA	K060415	2007	
BANDA-TOMA DE FUERZA-AA	9420	TERMOSTATO-190°	33579
BANDA-TOMA DE FUERZA-AA	PQ17420	TERMOSTATO-180°	33576
MANGUERA INFERIOR-MOTOR A TUBO	24440	TERMOSTATO-180°	33578
MANGUERA SILICÓN-MOTOR A TUBO	SIH250363C	TERMOSTATO-170°	33577
MANGUERA SUPERIOR-MOTOR A TUBO	24440	2006	
BANDA-ALT	8435 GS	TERMOSTATO-190°	33579
BANDA-ALT	9435	TERMOSTATO-180°	33576
TERMOSTATO-190°	33579	TERMOSTATO-180°	33578
TERMOSTATO-180°	33576	TERMOSTATO-170°	33577
TERMOSTATO-180°	33578	2005	
TERMOSTATO-170°	33577	TERMOSTATO-190°	33579
2000		TERMOSTATO-180°	33576
MANGUERA SUPERIOR-TUBO A TUBO	21135	TERMOSTATO-180°	33578
MANGUERA SILICÓN-TUBO A RAD.	SIH250363C	TERMOSTATO-170°	33577
BANDA-TOMA DE FUERZA-VENT	K140429	2004	
BANDA-TOMA DE FUERZA-BA	K060425	MANGUERA SILICÓN-TUBO A RAD.	SIH250363C
BANDA-TOMA DE FUERZA-AA	9420	MANGUERA SUPERIOR-TUBO A RAD.	21492
MANGUERA SILICÓN-MOTOR A TUBO	SIH250363C	MANGUERA INFERIOR-MOTOR A TUBO	21891
MANGUERA SUPERIOR-MOTOR A TUBO	21135	MANGUERA SUPERIOR-MOTOR A TUBO	20206
BANDA-ALT	9435	BANDA-ALT-VENT-AA	K080825
TERMOSTATO-190°	33579	TERMOSTATO-190°	33579
TERMOSTATO-180°	33576	TERMOSTATO-180°	33576
TERMOSTATO-180°	33578	TERMOSTATO-180°	33578
TERMOSTATO-170°	33577	TERMOSTATO-170°	33577
CUMMINS ISM DIESEL		CATERPILLAR C16 DIESEL	
2001		2000	
BANDA-VENT	K140516	BANDA-VENT-AA	9485
MANGUERA SILICÓN-TUBO A RAD.	SIH250363C	BANDA-VENT	K140580
BANDA-TOMA DE FUERZA-ALT	K050360	MANGUERA INFERIOR-TUBO A RAD.	CHARTER 2 1/2"
BANDA-TOMA DE FUERZA-AA	9480	MANGUERA SUPERIOR-TUBO A RAD.	21135
MANGUERA SILICÓN-MOTOR A TUBO	SIH200363C	MANGUERA INFERIOR-MOTOR A TUBO	21891
MANGUERA SILICÓN-MOTOR A TUBO	SIH250363C	MANGUERA SUPERIOR-MOTOR A TUBO	CHARTER 2 1/2"
MANGUERA SILICÓN-MOTOR A RAD.	SIH250363C	BANDA-ALT-VENT	9470



MASTER SERVICIO PESADO 2014

STERLING

A-LINE

TERMOSTATO-190°	33579	TERMOSTATO-170°	33577
TERMOSTATO-180°	33576	2003	
TERMOSTATO-180°	33578	TERMOSTATO-190°	33579
TERMOSTATO-170°	33577	TERMOSTATO-180°	33576
CATERPILLAR C15 DIESEL		TERMOSTATO-180°	33578
2008		TERMOSTATO-170°	33577
TERMOSTATO-190°	33579	2002	
TERMOSTATO-180°	33576	TERMOSTATO-190°	33579
TERMOSTATO-180°	33578	TERMOSTATO-180°	33576
TERMOSTATO-170°	33577	TERMOSTATO-180°	33578
2007		TERMOSTATO-170°	33577
POLEA-MOTOR	36091	2001	
POLEA-MOTOR	36093	BANDA-VENT-AA	9485
TERMOSTATO-190°	33579	BANDA-VENT	K140580
TERMOSTATO-180°	33576	MANGUERA INFERIOR-TUBO A RAD.	CHARTER 2 1/2"
TERMOSTATO-180°	33578	MANGUERA SUPERIOR-TUBO A RAD.	21135
TERMOSTATO-170°	33577	MANGUERA INFERIOR-MOTOR A TUBO	21891
2006		MANGUERA SUPERIOR-MOTOR A TUBO	CHARTER 2 1/2"
MANGUERA SUPERIOR-MOTOR A RAD.	22980	BANDA-ALT-VENT	9470
POLEA-MOTOR	36091	TERMOSTATO-190°	33579
POLEA-MOTOR	36093	TERMOSTATO-180°	33576
BANDA-ALT-VENT-AA	K081005	TERMOSTATO-180°	33578
TENSOR-ALT-VENT-AA	38590	TERMOSTATO-170°	33577
TERMOSTATO-190°	33579	2000	
TERMOSTATO-180°	33576	BANDA-VENT-AA	9485
TERMOSTATO-180°	33578	BANDA-VENT	K140580
TERMOSTATO-170°	33577	MANGUERA INFERIOR-TUBO A RAD.	CHARTER 2 1/2"
2005		MANGUERA SUPERIOR-TUBO A RAD.	21135
MANGUERA SUPERIOR-MOTOR A RAD.	22980	MANGUERA INFERIOR-MOTOR A TUBO	21891
POLEA-MOTOR	36091	MANGUERA SUPERIOR-MOTOR A TUBO	CHARTER 2 1/2"
POLEA-MOTOR	36093	BANDA-ALT-VENT	9470
BANDA-ALT-VENT-AA	K081005	TERMOSTATO-190°	33579
TENSOR-ALT-VENT-AA	38590	TERMOSTATO-180°	33576
TERMOSTATO-190°	33579	TERMOSTATO-180°	33578
TERMOSTATO-180°	33576	TERMOSTATO-170°	33577
TERMOSTATO-180°	33578	CATERPILLAR C13 DIESEL	
TERMOSTATO-170°	33577	2008	
2004		TERMOSTATO-190°	33579
POLEA-MOTOR	36091	TERMOSTATO-180°	33576
POLEA-MOTOR	36093	TERMOSTATO-180°	33578
TERMOSTATO-190°	33579	TERMOSTATO-170°	33577
TERMOSTATO-180°	33576	2007	
TERMOSTATO-180°	33578	POLEA-MOTOR	36093



MASTER SERVICIO PESADO 2014

STERLING

A-LINE

TERMOSTATO-190°	33579	TERMOSTATO-180°	33578
TERMOSTATO-180°	33576	TERMOSTATO-170°	33577
TERMOSTATO-180°	33578	POLEA DEL TENSOR-	36091
TERMOSTATO-170°	33577	2003	
2006		MANGUERA SILICÓN-RAD. A TUBO	SIH250363C
MANGUERA SUPERIOR-MOTOR A RAD.	22980	MANGUERA SILICÓN-MOTOR A TUBO	SIH250363C
POLEA-MOTOR	36093	BANDA-ALT-VENT	K080897
BANDA-ALT-VENT-AA	K081005	POLEA-ALT-VENT	36091
TENSOR-ALT-VENT-AA	38590	TENSOR-ALT-VENT	38506
TERMOSTATO-190°	33579	BANDA-AA	K060523
TERMOSTATO-180°	33576	TENSOR-AA	38524
TERMOSTATO-180°	33578	TERMOSTATO-190°	33579
TERMOSTATO-170°	33577	TERMOSTATO-180°	33576
2005		TERMOSTATO-180°	33578
MANGUERA SUPERIOR-MOTOR A RAD.	22980	TERMOSTATO-170°	33577
POLEA-MOTOR	36093	POLEA DEL TENSOR-	36091
BANDA-ALT-VENT-AA	K081005	2002	
TENSOR-ALT-VENT-AA	38590	MANGUERA SILICÓN-RAD. A TUBO	SIH250363C
TERMOSTATO-190°	33579	MANGUERA SILICÓN-MOTOR A TUBO	SIH250363C
TERMOSTATO-180°	33576	BANDA-ALT-VENT	K080897
TERMOSTATO-180°	33578	POLEA-ALT-VENT	36091
TERMOSTATO-170°	33577	TENSOR-ALT-VENT	38506
2004		BANDA-AA	K060523
MANGUERA INFERIOR-RAD. A TUBO	21891	TENSOR-AA	38524
MANGUERA SILICÓN-MOTOR A TUBO	SIH250363C	TERMOSTATO-190°	33579
MANGUERA SUPERIOR-MOTOR A RAD.	22980	TERMOSTATO-180°	33576
POLEA-MOTOR	36093	TERMOSTATO-180°	33578
BANDA-ALT-VENT-AA	K081005	TERMOSTATO-170°	33577
TERMOSTATO-190°	33579	POLEA DEL TENSOR-	36091
TERMOSTATO-180°	33576	2001	
TERMOSTATO-180°	33578	BANDA-VENT-AA	9465
TERMOSTATO-170°	33577	BANDA-VENT	K140603
CATERPILLAR C12 DIESEL		MANGUERA SILICÓN-TUBO A RAD.	SIH250363C
2004		MANGUERA SILICÓN-MOTOR A TUBO	SIH250363C
MANGUERA SILICÓN-RAD. A TUBO	SIH250363C	MANGUERA SUPERIOR-MOTOR A TUBO	21135
MANGUERA SILICÓN-MOTOR A TUBO	SIH250363C	BANDA-ALT-VENT	9440
BANDA-ALT-VENT	K080897	TERMOSTATO-190°	33579
POLEA-ALT-VENT	36091	TERMOSTATO-180°	33576
TENSOR-ALT-VENT	38506	TERMOSTATO-180°	33578
BANDA-AA	K060523	TERMOSTATO-170°	33577
TENSOR-AA	38524	2000	
TERMOSTATO-190°	33579	BANDA-VENT-AA	9465
TERMOSTATO-180°	33576	BANDA-VENT	K140603



MANGUERA SILICÓN-TUBO A RAD.	SIH250363C
MANGUERA SILICÓN-MOTOR A TUBO	SIH250363C
MANGUERA SUPERIOR-MOTOR A TUBO	21135
BANDA-ALT-VENT	9440
TERMOSTATO-190°	33579
TERMOSTATO-180°	33576
TERMOSTATO-180°	33578
TERMOSTATO-170°	33577

CATERPILLAR C11 DIESEL

2007

POLEA-MOTOR	36093
TERMOSTATO-190°	33579
TERMOSTATO-180°	33576
TERMOSTATO-180°	33578
TERMOSTATO-170°	33577

2006

MANGUERA SUPERIOR-MOTOR A RAD.	22980
POLEA-MOTOR	36093
BANDA-ALT-VENT-AA	K081005
TENSOR-ALT-VENT-AA	38590
TERMOSTATO-190°	33579
TERMOSTATO-180°	33576
TERMOSTATO-180°	33578
TERMOSTATO-170°	33577

2005

MANGUERA SUPERIOR-MOTOR A RAD.	22980
POLEA-MOTOR	36093
BANDA-ALT-VENT-AA	K081005
TENSOR-ALT-VENT-AA	38590
TERMOSTATO-190°	33579
TERMOSTATO-180°	33576
TERMOSTATO-180°	33578
TERMOSTATO-170°	33577

2004

MANGUERA INFERIOR-MOTOR A RAD.	22952
MANGUERA SUPERIOR-MOTOR A RAD.	22980
POLEA-MOTOR	36093
BANDA-ALT-VENT-AA	K081079
TENSOR-ALT-VENT-AA	38590
TERMOSTATO-190°	33579
TERMOSTATO-180°	33576
TERMOSTATO-180°	33578
TERMOSTATO-170°	33577

CATERPILLAR C10 DIESEL

2004

MANGUERA SILICÓN-RAD. A TUBO	SIH250363C
MANGUERA SILICÓN-MOTOR A TUBO	SIH250363C
BANDA-ALT-VENT	K080897
POLEA-ALT-VENT	36091
TENSOR-ALT-VENT	38506
BANDA-AA	K060523
TENSOR-AA	38524
TERMOSTATO-190°	33579
TERMOSTATO-180°	33576
TERMOSTATO-180°	33578
TERMOSTATO-170°	33577
POLEA DEL TENSOR-	36091

2003

MANGUERA SILICÓN-RAD. A TUBO	SIH250363C
MANGUERA SILICÓN-MOTOR A TUBO	SIH250363C
BANDA-ALT-VENT	K080897
POLEA-ALT-VENT	36091
TENSOR-ALT-VENT	38506
BANDA-AA	K060523
TENSOR-AA	38524
TERMOSTATO-190°	33579
TERMOSTATO-180°	33576
TERMOSTATO-180°	33578
TERMOSTATO-170°	33577
POLEA DEL TENSOR-	36091

2002

MANGUERA SILICÓN-RAD. A TUBO	SIH250363C
MANGUERA SILICÓN-MOTOR A TUBO	SIH250363C
BANDA-ALT-VENT	K080897
POLEA-ALT-VENT	36091
TENSOR-ALT-VENT	38506
BANDA-AA	K060523
TENSOR-AA	38524
TERMOSTATO-190°	33579
TERMOSTATO-180°	33576
TERMOSTATO-180°	33578
TERMOSTATO-170°	33577
POLEA DEL TENSOR-	36091

2001

BANDA-VENT-AA	9465
BANDA-VENT	K140603



MANGUERA SILICÓN-TUBO A RAD. SIH250363C

MANGUERA SILICÓN-MOTOR A TUBO SIH250363C

MANGUERA SUPERIOR-MOTOR A TUBO 21135

BANDA-ALT-VENT 9440

TERMOSTATO-190° 33579

TERMOSTATO-180° 33576

TERMOSTATO-180° 33578

TERMOSTATO-170° 33577

2000

BANDA-VENT-AA 9465

BANDA-VENT K140603

MANGUERA SILICÓN-TUBO A RAD. SIH250363C

MANGUERA SILICÓN-MOTOR A TUBO SIH250363C

MANGUERA SUPERIOR-MOTOR A TUBO 21135

BANDA-ALT-VENT 9440

TERMOSTATO-190° 33579

TERMOSTATO-180° 33576

TERMOSTATO-180° 33578

TERMOSTATO-170° 33577

CATERPILLAR 3406 DIESEL

2001

BANDA-VENT K140580

MANGUERA SILICÓN-TUBO A RAD. SIH250363C

MANGUERA SILICÓN-MOTOR A TUBO SIH300363C

BANDA-ALT 9480

TERMOSTATO-190° 33579

TERMOSTATO-180° 33576

TERMOSTATO-180° 33578

TERMOSTATO-170° 33577

BANDA- 9485

MANGUERA SILICÓN- SIH250363C

2000

BANDA-VENT K140580

MANGUERA SILICÓN-TUBO A RAD. SIH250363C

MANGUERA SILICÓN-MOTOR A TUBO SIH300363C

BANDA-ALT 9480

TERMOSTATO-190° 33579

TERMOSTATO-180° 33576

TERMOSTATO-180° 33578

TERMOSTATO-170° 33577

BANDA- 9485

MANGUERA SILICÓN- SIH250363C

BULLET

CUMMINS ISB-07 DIESEL

2008

BANDA-BA-VENT-AA K081359

TERMOSTATO-190° 33915

TERMOSTATO-180° 33956

L-LINE

MERCEDES-BENZ MBE 4000 DIESEL

2007

BANDA-VENT K080505

BANDA-VENT K080660

TENSOR-VENT 38597

BANDA-TOMA DE FUERZA-ALT-AA K080855

POLEA DEL TENSOR-TOMA DE FUERZA-ALT-AA 38075

TENSOR-TOMA DE FUERZA-ALT-AA 38501

MANGUERA INFERIOR-RAD. A TUBO 21135

MANGUERA SUPERIOR-RAD. A TUBO 21891

MANGUERA SILICÓN-MOTOR A TUBO SIH250363C

2006

BANDA-VENT K080545

TENSOR-VENT 38597

BANDA-TOMA DE FUERZA-ALT-AA K080855

POLEA DEL TENSOR-TOMA DE FUERZA-ALT-AA 38075

TENSOR-TOMA DE FUERZA-ALT-AA 38501

MANGUERA INFERIOR-MOTOR A RAD. 23014

2005

BANDA-VENT K080545

TENSOR-VENT 38597

MANGUERA SILICÓN-TUBO A RAD. SIH250363C

BANDA-TOMA DE FUERZA-ALT-AA K080855

POLEA DEL TENSOR-TOMA DE FUERZA-ALT-AA 38075

TENSOR-TOMA DE FUERZA-ALT-AA 38501

MANGUERA INFERIOR-MOTOR A TUBO 21891

MANGUERA SUPERIOR-MOTOR A RAD. 22850

2004

BANDA-VENT K080545

TENSOR-VENT 38597

MANGUERA SILICÓN-TUBO A RAD. SIH250363C

BANDA-TOMA DE FUERZA-ALT-AA K080855

POLEA DEL TENSOR-TOMA DE FUERZA-ALT-AA 38075

TENSOR-TOMA DE FUERZA-ALT-AA 38501

MANGUERA INFERIOR-MOTOR A TUBO 21891

MANGUERA SUPERIOR-MOTOR A RAD. 22850



2003

BANDA-VENT	K080545
TENSOR-VENT	38597
MANGUERA SILICÓN-TUBO A RAD.	SIH250363C
BANDA-TOMA DE FUERZA-ALT-AA	K080855
POLEA DEL TENSOR-TOMA DE FUERZA-ALT-AA	38075
TENSOR-TOMA DE FUERZA-ALT-AA	38501
MANGUERA INFERIOR-MOTOR A TUBO	21891
MANGUERA SUPERIOR-MOTOR A RAD.	22850

DETROIT DIESEL SERIES 55 DIESEL

2001

TERMOSTATO-190°	33599
-----------------	-------

DETROIT DIESEL SERIE 60

2006

BANDA-VENT	K100579
POLEA-VENT	38076
TENSOR-VENT	38503
BANDA-TOMA DE FUERZA-ALT-AA	K080565
POLEA-TOMA DE FUERZA-ALT-AA	38075
TENSOR-TOMA DE FUERZA-ALT-AA	38501
MANGUERA INFERIOR-RAD. A TUBO	20748
MANGUERA SUPERIOR-RAD. A TUBO	21115
MANGUERA INFERIOR-MOTOR A TUBO	24436
MANGUERA SUPERIOR-MOTOR A TUBO	24440

2005

BANDA-VENT	K100579
POLEA-VENT	38076
TENSOR-VENT	38503
BANDA-TOMA DE FUERZA-ALT-AA	K080565
POLEA-TOMA DE FUERZA-ALT-AA	38075
TENSOR-TOMA DE FUERZA-ALT-AA	38501
MANGUERA SUPERIOR-MOTOR A TUBO	21891

2004

BANDA-VENT	K100579
POLEA-VENT	38076
TENSOR-VENT	38503
BANDA-TOMA DE FUERZA-ALT-AA	K080565
POLEA-TOMA DE FUERZA-ALT-AA	38075
TENSOR-TOMA DE FUERZA-ALT-AA	38501
MANGUERA SUPERIOR-MOTOR A TUBO	21891

2003

BANDA-VENT	8494 GS
MANGUERA INFERIOR-TUBOO A RAD.	24440

MANGUERA SUPERIOR-TUBO A RAD.	24440
BANDA-TOMA DE FUERZA-ALT-AA	K080565
POLEA-TOMA DE FUERZA-ALT-AA	38075
TENSOR-TOMA DE FUERZA-ALT-AA	38502
MANGUERA INFERIOR-MOTOR A TUBO	21891
MANGUERA SUPERIOR-MOTOR A TUBO	21891

2002

BANDA-VENT	K140496
MANGUERA INFERIOR-TUBOO A RAD.	24440
MANGUERA SUPERIOR-TUBO A RAD.	21891
BANDA-TOMA DE FUERZA-ALT-AA	K080565
TENSOR-TOMA DE FUERZA-ALT-AA	38501
MANGUERA INFERIOR-MOTOR A TUBO	21891
MANGUERA SUPERIOR-MOTOR A TUBO	24440

2001

BANDA-VENT	K140496
MANGUERA INFERIOR-TUBOO A RAD.	24440
MANGUERA SUPERIOR-TUBO A RAD.	24440
BANDA-TOMA DE FUERZA-ALT	K060420
POLEA-TOMA DE FUERZA-ALT	38075
TENSOR-TOMA DE FUERZA-ALT	38502
BANDA-TOMA DE FUERZA-AA	8371 GS
MANGUERA INFERIOR-MOTOR A TUBO	24440

DETROIT DIESEL 6 CIL, 14.0 L DIESEL

2008

BANDA-VENT	K100502
POLEA DEL TENSOR-VENT	38076
TENSOR-VENT	38503
BANDA-TOMA DE FUERZA-ALT-AA	K080570
POLEA DEL TENSOR-TOMA DE FUERZA-ALT-AA	38075
TENSOR-TOMA DE FUERZA-ALT-AA	38501
MANGUERA SILICÓN-RAD. A TUBO	SIH250363C
MANGUERA SILICÓN-MOTOR A TUBO	SIH250363C

2007

BANDA-VENT	K100579
POLEA DEL TENSOR-VENT	38076
TENSOR-VENT	38503
BANDA-TOMA DE FUERZA-ALT-AA	K080565
POLEA DEL TENSOR-TOMA DE FUERZA-ALT-AA	38075
TENSOR-TOMA DE FUERZA-ALT-AA	38501
MANGUERA INFERIOR-RAD. A TUBO	21135
MANGUERA SUPERIOR-RAD. A TUBO	21115
MANGUERA INFERIOR-MOTOR A TUBO	24436



MANGUERA SILICÓN-MOTOR A TUBO	SIH250363C	DETROIT DIESEL 6 CIL, 12.7 L DIESEL	
TERMOSTATO-190°	33599	2008	
2006		BANDA-VENT	K100502
BANDA-VENT	K100579	POLEA DEL TENSOR-VENT	38076
POLEA DEL TENSOR-VENT	38076	TENSOR-VENT	38503
TENSOR-VENT	38503	BANDA-TOMA DE FUERZA-ALT-AA	K080570
BANDA-TOMA DE FUERZA-ALT-AA	K080565	POLEA DEL TENSOR-TOMA DE FUERZA-ALT-AA	38075
POLEA DEL TENSOR-TOMA DE FUERZA-ALT-AA	38075	TENSOR-TOMA DE FUERZA-ALT-AA	38501
TENSOR-TOMA DE FUERZA-ALT-AA	38501	MANGUERA SILICÓN-RAD. A TUBO	SIH250363C
MANGUERA INFERIOR-RAD. A TUBO	21135	MANGUERA SILICÓN-MOTOR A TUBO	SIH250363C
MANGUERA SUPERIOR-RAD. A TUBO	21115	2007	
MANGUERA INFERIOR-MOTOR A TUBO	24436	BANDA-VENT	K100579
MANGUERA SILICÓN-MOTOR A TUBO	SIH250363C	POLEA DEL TENSOR-VENT	38076
TERMOSTATO-190°	33599	TENSOR-VENT	38503
2005		BANDA-TOMA DE FUERZA-ALT-AA	K080565
BANDA-VENT	K100579	POLEA DEL TENSOR-TOMA DE FUERZA-ALT-AA	38075
POLEA DEL TENSOR-VENT	38076	TENSOR-TOMA DE FUERZA-ALT-AA	38501
TENSOR-VENT	38503	MANGUERA INFERIOR-RAD. A TUBO	21135
BANDA-TOMA DE FUERZA-ALT-AA	K080565	MANGUERA SUPERIOR-RAD. A TUBO	21115
POLEA DEL TENSOR-TOMA DE FUERZA-ALT-AA	38075	MANGUERA INFERIOR-MOTOR A TUBO	24436
TENSOR-TOMA DE FUERZA-ALT-AA	38501	MANGUERA SILICÓN-MOTOR A TUBO	SIH250363C
MANGUERA SILICÓN-RAD. A TUBO	SIH250363C	TERMOSTATO-190°	33599
MANGUERA SILICÓN-MOTOR A TUBO	SIH250363C	2006	
TERMOSTATO-190°	33599	BANDA-VENT	K100579
2004		POLEA DEL TENSOR-VENT	38076
BANDA-VENT	K100579	TENSOR-VENT	38503
POLEA DEL TENSOR-VENT	38076	BANDA-TOMA DE FUERZA-ALT-AA	K080565
TENSOR-VENT	38503	POLEA DEL TENSOR-TOMA DE FUERZA-ALT-AA	38075
BANDA-TOMA DE FUERZA-ALT-AA	K080545	TENSOR-TOMA DE FUERZA-ALT-AA	38501
POLEA DEL TENSOR-TOMA DE FUERZA-ALT-AA	38075	MANGUERA INFERIOR-RAD. A TUBO	21135
TENSOR-TOMA DE FUERZA-ALT-AA	38501	MANGUERA SUPERIOR-RAD. A TUBO	21115
MANGUERA SUPERIOR-MOTOR A TUBO	21891	MANGUERA INFERIOR-MOTOR A TUBO	24436
TERMOSTATO-190°	33599	MANGUERA SILICÓN-MOTOR A TUBO	SIH250363C
MANGUERA SILICÓN-	SIH250363C	TERMOSTATO-190°	33599
2003		2005	
BANDA-VENT	9495	BANDA-VENT	K100579
MANGUERA SILICÓN-TUBO A RAD.	SIH250363C	POLEA DEL TENSOR-VENT	38076
BANDA-TOMA DE FUERZA-ALT-AA	K080565	TENSOR-VENT	38503
POLEA DEL TENSOR-TOMA DE FUERZA-ALT-AA	38075	BANDA-TOMA DE FUERZA-ALT-AA	K080565
TENSOR-TOMA DE FUERZA-ALT-AA	38502	POLEA DEL TENSOR-TOMA DE FUERZA-ALT-AA	38075
MANGUERA INFERIOR-MOTOR A TUBO	21891	TENSOR-TOMA DE FUERZA-ALT-AA	38501
MANGUERA SUPERIOR-MOTOR A TUBO	21891	MANGUERA SILICÓN-RAD. A TUBO	SIH250363C
TERMOSTATO-190°	33599	MANGUERA SILICÓN-MOTOR A TUBO	SIH250363C



TERMOSTATO-190°	33599	BANDA-TOMA DE FUERZA-ALT	K060420
2004		POLEA-TOMA DE FUERZA-ALT	38075
BANDA-VENT	K100579	TENSOR-TOMA DE FUERZA-ALT	38502
POLEA DEL TENSOR-VENT	38076	BANDA-TOMA DE FUERZA-AA	9370
TENSOR-VENT	38503	MANGUERA SILICÓN-MOTOR A TUBO	SIH250363C
BANDA-TOMA DE FUERZA-ALT-AA	K080545	TERMOSTATO-190°	33599
POLEA DEL TENSOR-TOMA DE FUERZA-ALT-AA	38075	DETROIT DIESEL 6 CIL, 11.1 L DIESEL	
TENSOR-TOMA DE FUERZA-ALT-AA	38501	2002	
MANGUERA SUPERIOR-MOTOR A TUBO	21891	BANDA-VENT	K140496
TERMOSTATO-190°	33599	MANGUERA SILICÓN-TUBO A RAD.	SIH250363C
MANGUERA SILICÓN-	SIH250363C	MANGUERA SUPERIOR-TUBO A RAD.	21891
2003		BANDA-TOMA DE FUERZA-ALT-AA	K080565
BANDA-VENT	9495	TENSOR-TOMA DE FUERZA-ALT-AA	38501
MANGUERA SILICÓN-TUBO A RAD.	SIH250363C	MANGUERA INFERIOR-MOTOR A TUBO	21891
BANDA-TOMA DE FUERZA-ALT-AA	K080565	MANGUERA SILICÓN-MOTOR A TUBO	SIH250363C
POLEA DEL TENSOR-TOMA DE FUERZA-ALT-AA	38075	TERMOSTATO-190°	33599
TENSOR-TOMA DE FUERZA-ALT-AA	38502	2001	
MANGUERA INFERIOR-MOTOR A TUBO	21891	BANDA-VENT	K140496
MANGUERA SUPERIOR-MOTOR A TUBO	21891	MANGUERA SILICÓN-TUBO A RAD.	SIH250363C
TERMOSTATO-190°	33599	BANDA-TOMA DE FUERZA-ALT	2/9485FPB
2002		BANDA-TOMA DE FUERZA-ALT	K060420
BANDA-VENT	K140496	POLEA-TOMA DE FUERZA-ALT	38075
MANGUERA SILICÓN-TUBO A RAD.	SIH250363C	TENSOR-TOMA DE FUERZA-ALT	38502
MANGUERA SUPERIOR-TUBO A RAD.	21891	BANDA-TOMA DE FUERZA-AA	9370
BANDA-TOMA DE FUERZA-ALT-AA	K080565	MANGUERA SILICÓN-MOTOR A TUBO	SIH250363C
TENSOR-TOMA DE FUERZA-ALT-AA	38501	TERMOSTATO-190°	33599
MANGUERA INFERIOR-MOTOR A TUBO	21891	2000	
MANGUERA SILICÓN-MOTOR A TUBO	SIH250363C	BANDA-VENT	K140496
TERMOSTATO-190°	33599	MANGUERA SILICÓN-TUBO A RAD.	SIH250363C
2001		BANDA-TOMA DE FUERZA-ALT	2/9485FPB
BANDA-VENT	K140496	BANDA-TOMA DE FUERZA-ALT	K060420
MANGUERA SILICÓN-TUBO A RAD.	SIH250363C	POLEA-TOMA DE FUERZA-ALT	38075
BANDA-TOMA DE FUERZA-ALT	2/9485FPB	TENSOR-TOMA DE FUERZA-ALT	38502
BANDA-TOMA DE FUERZA-ALT	K060420	BANDA-TOMA DE FUERZA-AA	9370
POLEA-TOMA DE FUERZA-ALT	38075	MANGUERA SILICÓN-MOTOR A TUBO	SIH250363C
TENSOR-TOMA DE FUERZA-ALT	38502	TERMOSTATO-190°	33599
BANDA-TOMA DE FUERZA-AA	9370	CUMMINS SIGNATURE 600 DIESEL	
MANGUERA SILICÓN-MOTOR A TUBO	SIH250363C	2001	
TERMOSTATO-190°	33599	BANDA-VENT	K100810
2000		POLEA-VENT	36092
BANDA-VENT	K140496	POLEA DEL TENSOR-VENT	36092
MANGUERA SILICÓN-TUBO A RAD.	SIH250363C	TENSOR-VENT	38535
BANDA-TOMA DE FUERZA-ALT	2/9485FPB	MANGUERA INFERIOR-TUBO A RAD.	21135



MANGUERA SUPERIOR-TUBO A RAD.	21135	BANDA-TOMA DE FUERZA-BA	K060415
BANDA-TOMA DE FUERZA-ALT-AA	K060685	BANDA-TOMA DE FUERZA-AA	9420
POLEA-TOMA DE FUERZA-ALT-AA	36095	BANDA-TOMA DE FUERZA-AA	PQ17420
POLEA DEL TENSOR-TOMA DE FUERZA-ALT-AA	36095	MANGUERA INFERIOR-MOTOR A TUBO	24440
TENSOR-TOMA DE FUERZA-ALT-AA	38532	MANGUERA SILICÓN-MOTOR A TUBO	SIH250363C
MANGUERA INFERIOR-MOTOR A TUBO	21894	MANGUERA SUPERIOR-MOTOR A TUBO	24440
MANGUERA SILICÓN-MOTOR A TUBO	SIH250363C	BANDA-ALT	8435 GS
MANGUERA SUPERIOR-MOTOR A TUBO	24440	BANDA-ALT	9435
CUMMINS N14 DIESEL		TERMOSTATO-190°	33579
2003		TERMOSTATO-180°	33576
MANGUERA SILICÓN-TUBO A RAD.	SIH250363C	TERMOSTATO-180°	33578
MANGUERA SUPERIOR-TUBO A RAD.	21135	TERMOSTATO-170°	33577
BANDA-TOMA DE FUERZA-BA	K060415	2000	
BANDA-TOMA DE FUERZA-AA	9420	MANGUERA SUPERIOR-TUBO A TUBO	21135
MANGUERA SILICÓN-MOTOR A TUBO	SIH250363C	MANGUERA SILICÓN-TUBO A RAD.	SIH250363C
BANDA-ALT	9435	BANDA-TOMA DE FUERZA-VENT	K140429
TERMOSTATO-190°	33579	BANDA-TOMA DE FUERZA-BA	K060425
TERMOSTATO-180°	33576	BANDA-TOMA DE FUERZA-AA	9420
TERMOSTATO-180°	33578	MANGUERA SILICÓN-MOTOR A TUBO	SIH250363C
TERMOSTATO-170°	33577	MANGUERA SUPERIOR-MOTOR A TUBO	21135
2002		BANDA-ALT	9435
MANGUERA INFERIOR-TUBOO A RAD.	24440	TERMOSTATO-190°	33579
MANGUERA INFERIOR-TUBO A RAD.	21135	TERMOSTATO-180°	33576
MANGUERA SILICÓN-TUBO A RAD.	SIH250363C	TERMOSTATO-180°	33578
MANGUERA SUPERIOR-TUBO A RAD.	21135	TERMOSTATO-170°	33577
BANDA-TOMA DE FUERZA-BA	K060415	CUMMINS ISX DIESEL	
BANDA-TOMA DE FUERZA-AA	9420	2001	
BANDA-TOMA DE FUERZA-AA	PQ17420	BANDA-VENT	K100810
MANGUERA INFERIOR-MOTOR A TUBO	24440	POLEA DEL TENSOR-VENT	36092
MANGUERA SILICÓN-MOTOR A TUBO	SIH250363C	TENSOR-VENT	38535
MANGUERA SUPERIOR-MOTOR A TUBO	24440	MANGUERA INFERIOR-TUBO A RAD.	21135
BANDA-ALT	8435 GS	MANGUERA SUPERIOR-TUBO A RAD.	21135
BANDA-ALT	9435	BANDA-TOMA DE FUERZA-ALT-AA	K060685
TERMOSTATO-190°	33579	POLEA DEL TENSOR-TOMA DE FUERZA-ALT-AA	36095
TERMOSTATO-180°	33576	TENSOR-TOMA DE FUERZA-ALT-AA	38532
TERMOSTATO-180°	33578	MANGUERA INFERIOR-MOTOR A TUBO	21894
TERMOSTATO-170°	33577	MANGUERA SILICÓN-MOTOR A TUBO	SIH250363C
2001		CUMMINS ISM DIESEL	
MANGUERA INFERIOR-TUBOO A RAD.	24440	2003	
MANGUERA INFERIOR-TUBO A RAD.	21135	BANDA-VENT	K140516
MANGUERA SILICÓN-TUBO A RAD.	SIH250363C	MANGUERA SILICÓN-TUBO A RAD.	SIH250363C
MANGUERA SUPERIOR-TUBO A RAD.	21135	BANDA-TOMA DE FUERZA-ALT	K050360
BANDA-TOMA DE FUERZA-VENT	K140429	BANDA-TOMA DE FUERZA-AA	9480



MASTER SERVICIO PESADO 2014

STERLING

L-LINE

MANGUERA SILICÓN-MOTOR A TUBO	SIH200363C	POLEA DEL TENSOR-TOMA DE FUERZA-ALT-VENT	36091
MANGUERA SILICÓN-MOTOR A TUBO	SIH250363C	TENSOR-TOMA DE FUERZA-ALT-VENT	38513
MANGUERA SILICÓN-MOTOR A RAD.	SIH250363C	BANDA-TOMA DE FUERZA-ALT-AA	K060685
2002		MANGUERA INFERIOR-MOTOR A TUBO	21891
BANDA-VENT	K140516	MANGUERA SUPERIOR-MOTOR A TUBO	CHARTER 2 1/2"
MANGUERA SILICÓN-TUBO A RAD.	SIH250363C	TERMOSTATO-180°-C/DOBLE TERMOSTATO	33966
BANDA-TOMA DE FUERZA-ALT	K050360	TERMOSTATO-180°	33959
BANDA-TOMA DE FUERZA-AA	9480	2000	
MANGUERA SILICÓN-MOTOR A TUBO	SIH200363C	BANDA-VENT-AA	9463
MANGUERA SILICÓN-MOTOR A TUBO	SIH250363C	MANGUERA INFERIOR-TUBO A RAD.	CHARTER 2 1/2"
MANGUERA SILICÓN-MOTOR A RAD.	SIH250363C	MANGUERA SUPERIOR-TUBO A RAD.	CHARTER 2 1/2"
2001		BANDA-TOMA DE FUERZA-ALT-VENT	K080733
BANDA-VENT	K140516	POLEA DEL TENSOR-TOMA DE FUERZA-ALT-VENT	36091
MANGUERA SILICÓN-TUBO A RAD.	SIH250363C	TENSOR-TOMA DE FUERZA-ALT-VENT	38513
BANDA-TOMA DE FUERZA-ALT	K050360	MANGUERA INFERIOR-MOTOR A TUBO	21891
BANDA-TOMA DE FUERZA-AA	9480	MANGUERA SUPERIOR-MOTOR A TUBO	CHARTER 2 1/2"
MANGUERA SILICÓN-MOTOR A TUBO	SIH200363C	TERMOSTATO-180°-C/DOBLE TERMOSTATO	33966
MANGUERA SILICÓN-MOTOR A TUBO	SIH250363C	TERMOSTATO-180°	33959
MANGUERA SILICÓN-MOTOR A RAD.	SIH250363C	CUMMINS ISB DIESEL	
2000		2003	
BANDA-VENT	K140516	TERMOSTATO-190°	33915
MANGUERA SILICÓN-TUBO A RAD.	SIH250363C	TERMOSTATO-180°	33956
BANDA-TOMA DE FUERZA-ALT	K050360	2002	
BANDA-TOMA DE FUERZA-AA	9480	TERMOSTATO-190°	33915
MANGUERA SILICÓN-MOTOR A TUBO	SIH200363C	TERMOSTATO-180°	33956
MANGUERA SILICÓN-MOTOR A TUBO	SIH250363C	2001	
MANGUERA SILICÓN-MOTOR A RAD.	SIH250363C	TERMOSTATO-190°	33915
CUMMINS ISC DIESEL		TERMOSTATO-180°	33956
2003		2000	
BANDA-VENT-AA	9463	BANDA-VENT-AA	9775
MANGUERA INFERIOR-TUBO A RAD.	CHARTER 2 1/2"	MANGUERA INFERIOR-TUBO A RAD.	CHARTER 2 1/2"
MANGUERA SUPERIOR-TUBO A RAD.	CHARTER 2 1/2"	MANGUERA SUPERIOR-TUBO A RAD.	CHARTER 2 1/2"
POLEA DEL TENSOR-TOMA DE FUERZA-ALT-VENT	36091	BANDA-TOMA DE FUERZA-ALT-VENT	K080726
TENSOR-TOMA DE FUERZA-ALT-VENT	38513	POLEA DEL TENSOR-TOMA DE FUERZA-ALT-VENT	36093
MANGUERA INFERIOR-MOTOR A TUBO	21891	TENSOR-TOMA DE FUERZA-ALT-VENT	38516
MANGUERA SUPERIOR-MOTOR A TUBO	CHARTER 2 1/2"	MANGUERA INFERIOR-MOTOR A TUBO	21891
BANDA-ALT-VENT	K080730	MANGUERA SUPERIOR-MOTOR A TUBO	CHARTER 2"
2001		TERMOSTATO-190°	33915
BANDA-VENT-AA	9463	TERMOSTATO-180°	33956
MANGUERA INFERIOR-TUBO A RAD.	CHARTER 2 1/2"	CATERPILLAR C9 DIESEL	
MANGUERA SUPERIOR-TUBO A RAD.	CHARTER 2 1/2"	2007	
BANDA-TOMA DE FUERZA-VENT	K100810	MANGUERA INFERIOR-MOTOR A RAD.	22952
BANDA-TOMA DE FUERZA-ALT-VENT	K080733	MANGUERA SUPERIOR-MOTOR A RAD.	22980



MASTER SERVICIO PESADO 2014

STERLING

L-LINE

BANDA-ALT-VENT-AA	K081079	BANDA-ALT-VENT-AA C/ALT 140A	K080876
TENSOR-ALT-VENT-AA	38590	TENSOR-ALT-VENT-AA	38550
TERMOSTATO-190°	33579	TERMOSTATO-190°	33969
TERMOSTATO-180°	33576	TERMOSTATO-180°	33968
TERMOSTATO-180°	33578	2004	
TERMOSTATO-170°	33577	BANDA-BA	9341
2006		BANDA-ALT-VENT-AA	K080776
TERMOSTATO-190°	33579	TENSOR-ALT-VENT-AA	38511
TERMOSTATO-180°	33576	POLEA DEL TENSOR-ALT-BA-VENT	36091
TERMOSTATO-180°	33578	TERMOSTATO-190°	33969
TERMOSTATO-170°	33577	TERMOSTATO-180°	33968
POLEA-	36091	CATERPILLAR C16 DIESEL	
2005		2001	
MANGUERA SUPERIOR-MOTOR A RAD.	22980	BANDA-VENT-AA	9485
BANDA-ALT-VENT-AA	K081005	BANDA-VENT	K140580
TENSOR-ALT-VENT-AA	38590	MANGUERA INFERIOR-TUBO A RAD.	CHARTER 2 1/2"
TERMOSTATO-190°	33579	MANGUERA SUPERIOR-TUBO A RAD.	21135
TERMOSTATO-180°	33576	MANGUERA INFERIOR-MOTOR A TUBO	21891
TERMOSTATO-180°	33578	MANGUERA SUPERIOR-MOTOR A TUBO	CHARTER 2 1/2"
TERMOSTATO-170°	33577	BANDA-ALT-VENT	9470
2004		TERMOSTATO-190°	33579
MANGUERA SILICÓN-TUBO A RAD.	SIH250363C	TERMOSTATO-180°	33576
MANGUERA SUPERIOR-TUBO A RAD.	21492	TERMOSTATO-180°	33578
MANGUERA INFERIOR-MOTOR A TUBO	21891	TERMOSTATO-170°	33577
MANGUERA SUPERIOR-MOTOR A TUBO	20206	CATERPILLAR C15 DIESEL	
BANDA-ALT-VENT-AA	K080825	2008	
TERMOSTATO-190°	33579	MANGUERA INFERIOR-RAD. A TUBO	21891
TERMOSTATO-180°	33576	MANGUERA INFERIOR-MOTOR A TUBO	22707
TERMOSTATO-180°	33578	TERMOSTATO-190°	33579
TERMOSTATO-170°	33577	TERMOSTATO-180°	33576
CATERPILLAR C7 DIESEL		TERMOSTATO-180°	33578
2007		TERMOSTATO-170°	33577
POLEA-MOTOR	36091	2007	
BANDA-ALT-VENT	K080816	MANGUERA INFERIOR-TUBO A ENFRIADOR	21891
TENSOR-ALT-VENT	38586	MANGUERA INFERIOR-MOTOR A TUBO	22980
TERMOSTATO-190°	33969	MANGUERA SUPERIOR-MOTOR A RAD.	22980
TERMOSTATO-180°	33968	POLEA-MOTOR	36091
2006		POLEA-MOTOR	36093
POLEA-MOTOR	36091	MANGUERA INFERIOR-ENFRIADOR A TUBO	21891
TERMOSTATO-190°	33969	BANDA-ALT-VENT-AA	K081005
TERMOSTATO-180°	33968	BANDA-ALT-VENT-AA	K081079
2005		TENSOR-ALT-VENT-AA	38590
POLEA-MOTOR	36091	TERMOSTATO-190°	33579



MASTER SERVICIO PESADO 2014

STERLING

L-LINE

TERMOSTATO-180°	33576	BANDA-VENT	K140580
TERMOSTATO-180°	33578	MANGUERA INFERIOR-TUBO A RAD.	CHARTER 2 1/2"
TERMOSTATO-170°	33577	MANGUERA SUPERIOR-TUBO A RAD.	21135
2006		MANGUERA INFERIOR-MOTOR A TUBO	21891
MANGUERA INFERIOR-MOTOR A RAD.	22952	MANGUERA SUPERIOR-MOTOR A TUBO	CHARTER 2 1/2"
MANGUERA SUPERIOR-MOTOR A RAD.	22980	BANDA-ALT-VENT	9470
POLEA-MOTOR	36091	TERMOSTATO-190°	33579
POLEA-MOTOR	36093	TERMOSTATO-180°	33576
BANDA-ALT-VENT-AA	K081005	TERMOSTATO-180°	33578
BANDA-ALT-VENT-AA	K081079	TERMOSTATO-170°	33577
TENSOR-ALT-VENT-AA	38590	2001	
TERMOSTATO-190°	33579	BANDA-VENT-AA	9485
TERMOSTATO-180°	33576	BANDA-VENT	K140580
TERMOSTATO-180°	33578	MANGUERA INFERIOR-TUBO A RAD.	CHARTER 2 1/2"
TERMOSTATO-170°	33577	MANGUERA SUPERIOR-TUBO A RAD.	21135
2005		MANGUERA INFERIOR-MOTOR A TUBO	21891
MANGUERA INFERIOR-TUBO A ENFRIADOR	21891	MANGUERA SUPERIOR-MOTOR A TUBO	CHARTER 2 1/2"
MANGUERA INFERIOR-RAD. A TUBO	21135	BANDA-ALT-VENT	9470
MANGUERA SILICÓN-MOTOR A TUBO	SIH250363C	TERMOSTATO-190°	33579
MANGUERA SUPERIOR-MOTOR A RAD.	22980	TERMOSTATO-180°	33576
POLEA-MOTOR	36091	TERMOSTATO-180°	33578
POLEA-MOTOR	36093	TERMOSTATO-170°	33577
MANGUERA INFERIOR-ENFRIADOR A TUBO	21135	CATERPILLAR C13 DIESEL	
BANDA-ALT-VENT-AA	K081005	2008	
TENSOR-ALT-VENT-AA	38590	TERMOSTATO-190°	33579
TERMOSTATO-190°	33579	TERMOSTATO-180°	33576
TERMOSTATO-180°	33576	TERMOSTATO-180°	33578
TERMOSTATO-180°	33578	TERMOSTATO-170°	33577
TERMOSTATO-170°	33577	2007	
2004		MANGUERA INFERIOR-TUBO A ENFRIADOR	21891
POLEA-MOTOR	36091	MANGUERA SILICÓN-RAD. A TUBO	SIH250363C
POLEA-MOTOR	36093	MANGUERA SILICÓN-MOTOR A TUBO	SIH250363C
TERMOSTATO-190°	33579	MANGUERA SUPERIOR-MOTOR A RAD.	22980
TERMOSTATO-180°	33576	POLEA-MOTOR	36093
TERMOSTATO-180°	33578	MANGUERA INFERIOR-ENFRIADOR A TUBO	21891
TERMOSTATO-170°	33577	BANDA-ALT-VENT-AA	K081005
2003		BANDA-ALT-VENT-AA	K081079
TERMOSTATO-190°	33579	TENSOR-ALT-VENT-AA	38590
TERMOSTATO-180°	33576	TERMOSTATO-190°	33579
TERMOSTATO-180°	33578	TERMOSTATO-180°	33576
TERMOSTATO-170°	33577	TERMOSTATO-180°	33578
2002		TERMOSTATO-170°	33577
BANDA-VENT-AA	9485	2006	

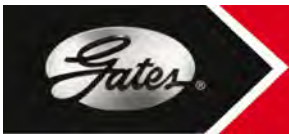

MASTER SERVICIO PESADO 2014

STERLING

L-LINE

MANGUERA INFERIOR-RAD. A TUBO	21135	BANDA-VENT-AA	9465
MANGUERA INFERIOR-MOTOR A TUBO	21135	BANDA-VENT	K140603
MANGUERA INFERIOR-MOTOR A RAD.	22952	MANGUERA SILICÓN-TUBO A RAD.	SIH250363C
MANGUERA SUPERIOR-MOTOR A RAD.	22980	MANGUERA SILICÓN-MOTOR A TUBO	SIH250363C
POLEA-MOTOR	36093	MANGUERA SUPERIOR-MOTOR A TUBO	22773
BANDA-ALT-VENT-AA	K081005	BANDA-ALT-VENT	9440
BANDA-ALT-VENT-AA	K081079	TERMOSTATO-190°	33579
TENSOR-ALT-VENT-AA	38590	TERMOSTATO-180°	33576
TERMOSTATO-190°	33579	TERMOSTATO-180°	33578
TERMOSTATO-180°	33576	TERMOSTATO-170°	33577
TERMOSTATO-180°	33578	2002	
TERMOSTATO-170°	33577	BANDA-VENT-AA	9440
2005		BANDA-VENT	K140682
MANGUERA SUPERIOR-MOTOR A RAD.	22980	MANGUERA SILICÓN-TUBO A RAD.	SIH250363C
POLEA-MOTOR	36093	MANGUERA SILICÓN-MOTOR A TUBO	SIH250363C
BANDA-ALT-VENT-AA	K081005	MANGUERA SUPERIOR-MOTOR A TUBO	21135
TENSOR-ALT-VENT-AA	38590	BANDA-ALT-VENT	9440
TERMOSTATO-190°	33579	TERMOSTATO-190°	33579
TERMOSTATO-180°	33576	TERMOSTATO-180°	33576
TERMOSTATO-180°	33578	TERMOSTATO-180°	33578
TERMOSTATO-170°	33577	TERMOSTATO-170°	33577
2004		2001	
MANGUERA SUPERIOR-MOTOR A RAD.	22980	BANDA-VENT-AA	9465
POLEA-MOTOR	36093	BANDA-VENT	K140603
BANDA-ALT-VENT-AA	K081005	MANGUERA SILICÓN-TUBO A RAD.	SIH250363C
TENSOR-ALT-VENT-AA	38590	MANGUERA SILICÓN-MOTOR A TUBO	SIH250363C
TERMOSTATO-190°	33579	MANGUERA SUPERIOR-MOTOR A TUBO	21135
TERMOSTATO-180°	33576	BANDA-ALT-VENT	9440
TERMOSTATO-180°	33578	TERMOSTATO-190°	33579
TERMOSTATO-170°	33577	TERMOSTATO-180°	33576
CATERPILLAR C12 DIESEL		TERMOSTATO-180°	33578
2004		TERMOSTATO-170°	33577
BANDA-VENT-AA	9465	2000	
BANDA-VENT	K140603	BANDA-VENT-AA	9465
MANGUERA SILICÓN-TUBO A RAD.	SIH250363C	BANDA-VENT	K140603
MANGUERA SILICÓN-MOTOR A TUBO	SIH250363C	MANGUERA SILICÓN-TUBO A RAD.	SIH250363C
MANGUERA SUPERIOR-MOTOR A TUBO	22773	MANGUERA SILICÓN-MOTOR A TUBO	SIH250363C
BANDA-ALT-VENT	9440	MANGUERA SUPERIOR-MOTOR A TUBO	21135
TERMOSTATO-190°	33579	BANDA-ALT-VENT	9440
TERMOSTATO-180°	33576	TERMOSTATO-190°	33579
TERMOSTATO-180°	33578	TERMOSTATO-180°	33576
TERMOSTATO-170°	33577	TERMOSTATO-180°	33578
2003		TERMOSTATO-170°	33577



CATERPILLAR C11 DIESEL

2007

MANGUERA INFERIOR-MOTOR A RAD.	22952
MANGUERA SUPERIOR-MOTOR A RAD.	22980
POLEA-MOTOR	36093
BANDA-ALT-VENT-AA	K081079
TENSOR-ALT-VENT-AA	38590
TERMOSTATO-190°	33579
TERMOSTATO-180°	33576
TERMOSTATO-180°	33578
TERMOSTATO-170°	33577

2006

MANGUERA INFERIOR-MOTOR A RAD.	22952
MANGUERA SUPERIOR-MOTOR A RAD.	22980
POLEA-MOTOR	36093
BANDA-ALT-VENT-AA	K081079
TENSOR-ALT-VENT-AA	38590
TERMOSTATO-190°	33579
TERMOSTATO-180°	33576
TERMOSTATO-180°	33578
TERMOSTATO-170°	33577

2005

MANGUERA INFERIOR-MOTOR A RAD.	22952
MANGUERA SUPERIOR-MOTOR A RAD.	22980
POLEA-MOTOR	36093
BANDA-ALT-VENT-AA	K081079
TENSOR-ALT-VENT-AA	38590
TERMOSTATO-190°	33579
TERMOSTATO-180°	33576
TERMOSTATO-180°	33578
TERMOSTATO-170°	33577

2004

MANGUERA INFERIOR-MOTOR A RAD.	22952
MANGUERA SUPERIOR-MOTOR A RAD.	22980
POLEA-MOTOR	36093
BANDA-ALT-VENT-AA	K081079
TENSOR-ALT-VENT-AA	38590
TERMOSTATO-190°	33579
TERMOSTATO-180°	33576
TERMOSTATO-180°	33578
TERMOSTATO-170°	33577

CATERPILLAR C10 DIESEL

2004

BANDA-VENT-AA	9465
BANDA-VENT	K140603
MANGUERA SILICÓN-TUBO A RAD.	SIH250363C
MANGUERA SILICÓN-MOTOR A TUBO	SIH250363C
MANGUERA SUPERIOR-MOTOR A TUBO	22773
BANDA-ALT-VENT	9440
TERMOSTATO-190°	33579
TERMOSTATO-180°	33576
TERMOSTATO-180°	33578
TERMOSTATO-170°	33577

2003

BANDA-VENT-AA	9465
BANDA-VENT	K140603
MANGUERA SILICÓN-TUBO A RAD.	SIH250363C
MANGUERA SILICÓN-MOTOR A TUBO	SIH250363C
MANGUERA SUPERIOR-MOTOR A TUBO	22773
BANDA-ALT-VENT	9440
TERMOSTATO-190°	33579
TERMOSTATO-180°	33576
TERMOSTATO-180°	33578
TERMOSTATO-170°	33577

2002

BANDA-VENT-AA	9440
BANDA-VENT	K140682
MANGUERA SILICÓN-TUBO A RAD.	SIH250363C
MANGUERA SILICÓN-MOTOR A TUBO	SIH250363C
MANGUERA SUPERIOR-MOTOR A TUBO	21135
BANDA-ALT-VENT	9440
TERMOSTATO-190°	33579
TERMOSTATO-180°	33576
TERMOSTATO-180°	33578
TERMOSTATO-170°	33577

2001

BANDA-VENT-AA	9465
BANDA-VENT	K140603
MANGUERA SILICÓN-TUBO A RAD.	SIH250363C
MANGUERA SILICÓN-MOTOR A TUBO	SIH250363C
MANGUERA SUPERIOR-MOTOR A TUBO	21135
BANDA-ALT-VENT	9440
TERMOSTATO-190°	33579
TERMOSTATO-180°	33576
TERMOSTATO-180°	33578
TERMOSTATO-170°	33577



2000			MANGUERA SUPERIOR-TUBO A RAD.	21571
BANDA-VENT-AA	9465		MANGUERA INFERIOR-MOTOR A TUBO	21571
BANDA-VENT	K140603		MANGUERA SUPERIOR-MOTOR A TUBO	20206
MANGUERA SILICÓN-TUBO A RAD.	SIH250363C		BANDA-BA	9341
MANGUERA SILICÓN-MOTOR A TUBO	SIH250363C		BANDA-ALT-VENT-AA	K080776
MANGUERA SUPERIOR-MOTOR A TUBO	21135		TENSOR-ALT-VENT-AA	38511
BANDA-ALT-VENT	9440		POLEA DEL TENSOR-ALT-BA-VENT	36091
TERMOSTATO-190°	33579		TERMOSTATO-190°	33969
TERMOSTATO-180°	33576		TERMOSTATO-180°	33968
TERMOSTATO-180°	33578		2003	
TERMOSTATO-170°	33577		MANGUERA INFERIOR-TUBOO A RAD.	24440
CATERPILLAR 3406 DIESEL			MANGUERA SILICÓN-TUBO A RAD.	SIH250363C
2001			MANGUERA SUPERIOR-TUBO A RAD.	21571
BANDA-VENT-AA	9420		MANGUERA INFERIOR-MOTOR A TUBO	21571
BANDA-VENT	K140662		MANGUERA SUPERIOR-MOTOR A TUBO	20206
MANGUERA SILICÓN-TUBO A RAD.	SIH250363C		BANDA-BA	8345 GS
MANGUERA SILICÓN-MOTOR A TUBO	SIH250363C		BANDA-BA	9341
MANGUERA SILICÓN-MOTOR A TUBO	SIH300363C		BANDA-ALT-VENT-AA	K080776
BANDA-ALT-VENT	9451		POLEA-ALT-VENT-AA	36091
TERMOSTATO-190°	33579		TENSOR-ALT-VENT-AA	38511
TERMOSTATO-180°	33576		POLEA DEL TENSOR-ALT-BA-VENT	36091
TERMOSTATO-180°	33578		TERMOSTATO-190°	33969
TERMOSTATO-170°	33577		TERMOSTATO-180°	33968
2000			2002	
BANDA-VENT-AA	9420		MANGUERA INFERIOR-TUBOO A RAD.	24440
BANDA-VENT	K140662		MANGUERA SILICÓN-TUBO A RAD.	SIH250363C
MANGUERA SILICÓN-TUBO A RAD.	SIH250363C		MANGUERA SUPERIOR-TUBO A RAD.	21571
MANGUERA SILICÓN-MOTOR A TUBO	SIH250363C		MANGUERA INFERIOR-MOTOR A TUBO	21571
MANGUERA SILICÓN-MOTOR A TUBO	SIH300363C		MANGUERA SUPERIOR-MOTOR A TUBO	20206
BANDA-ALT-VENT	9451		BANDA-BA	8345 GS
TERMOSTATO-190°	33579		BANDA-BA	9341
TERMOSTATO-180°	33576		BANDA-ALT-VENT-AA	K080776
TERMOSTATO-180°	33578		POLEA-ALT-VENT-AA	36091
TERMOSTATO-170°	33577		TENSOR-ALT-VENT-AA	38511
CATERPILLAR 3306 DIESEL			POLEA DEL TENSOR-ALT-BA-VENT	36091
2000			TERMOSTATO-190°	33969
BANDA-VENT	K080545		TERMOSTATO-180°	33968
BANDA-ALT	9490		2001	
TERMOSTATO-175°	33549		MANGUERA INFERIOR-TUBOO A RAD.	24440
BANDA-	9585		MANGUERA SILICÓN-TUBO A RAD.	SIH200363C
CATERPILLAR 3126 DIESEL			MANGUERA SILICÓN-TUBO A RAD.	SIH250363C
2004			MANGUERA SUPERIOR-TUBO A RAD.	24432
MANGUERA SILICÓN-TUBO A RAD.	SIH250363C		TENSOR-TOMA DE FUERZA-ALT-AA	38511



MANGUERA INFERIOR-MOTOR A TUBO	21135
MANGUERA SILICÓN-MOTOR A TUBO	SIH200363C
MANGUERA SUPERIOR-MOTOR A TUBO	24432
BANDA-BA	8345 GS
BANDA-BA	9341
BANDA-ALT-VENT-AA	K080780
POLEA-ALT-VENT-AA	36091
TENSOR-ALT-VENT-AA	38511
POLEA DEL TENSOR-ALT-BA-VENT	36091
TERMOSTATO-190°	33969
TERMOSTATO-180°	33968

2000

MANGUERA SILICÓN-TUBO A RAD.	SIH200363C
MANGUERA SILICÓN-TUBO A RAD.	SIH250363C
MANGUERA INFERIOR-MOTOR A TUBO	21135
MANGUERA SILICÓN-MOTOR A TUBO	SIH200363C
BANDA-BA	9341
BANDA-ALT-VENT-AA	K080780
TENSOR-ALT-VENT-AA	38511
POLEA DEL TENSOR-ALT-BA-VENT	36091
TERMOSTATO-190°	33969
TERMOSTATO-180°	33968

SILVER STAR

DETROIT DIESEL SERIE 60

2000

BANDA-VENT	K140496
MANGUERA SUPERIOR-TUBO A RAD.	CHARTER 2 1/2"
BANDA-TOMA DE FUERZA-ALT	9485
BANDA-TOMA DE FUERZA-ALT	K060420
BANDA-TOMA DE FUERZA-AA	8371 GS
MANGUERA INFERIOR-	CHARTER 2 1/2"

CUMMINS SIGNATURE 600 DIESEL

2001

MANGUERA INFERIOR-TUBO A RAD.	21135
MANGUERA INFERIOR-MOTOR A TUBO	21894
MANGUERA SUPERIOR-MOTOR A TUBO	CHARTER 2 1/2"
BANDA-BA-VENT	K100810
BANDA-ALT-BA-AA	K060685

CUMMINS N14 DIESEL

2000

BANDA-VENT	K120433
BANDA-BA	K060433
BANDA-ALT	PQ17430

CATERPILLAR C15 DIESEL

2000

BANDA-VENT-AA	PQ17490
BANDA-VENT	K140433
MANGUERA INFERIOR-TUBO A RAD.	21891
MANGUERA INFERIOR-MOTOR A TUBO	21042
MANGUERA SUPERIOR-MOTOR A TUBO	CHARTER 2 1/2"
BANDA-ALT-VENT	PQ17480
TERMOSTATO-175°	33549
MANGUERA INFERIOR-	CHARTER 3"

CATERPILLAR 3406 DIESEL

2000

BANDA-VENT-AA	PQ17480
BANDA-VENT	K140580
MANGUERA SUPERIOR-TUBO A RAD.	CHARTER 2 1/2"
MANGUERA SUPERIOR-MOTOR A TUBO	CHARTER 2 1/2"
BANDA-ALT VENT (ALT DELCO 130A)	PQ17480
TERMOSTATO-175°	33549
MANGUERA INFERIOR-	CHARTER 2 1/2"
MANGUERA INFERIOR-	CHARTER 3"

1999

BANDA-VENT-AA	PQ17480
BANDA-VENT	K140580
MANGUERA SUPERIOR-TUBO A RAD.	CHARTER 2 1/2"
MANGUERA SUPERIOR-MOTOR A TUBO	CHARTER 2 1/2"
BANDA-ALT VENT (ALT DELCO 130A)	PQ17480
TERMOSTATO-175°	33549
MANGUERA INFERIOR-	CHARTER 2 1/2"
MANGUERA INFERIOR-	CHARTER 3"

TORTON

CUMMINS ISB DIESEL

2000

BANDA-ALT	K080730
-----------	---------

TRACTO

CUMMINS N14 DIESEL

2000

BANDA-VENT	K120433
BANDA-BA	K060433
BANDA-ALT	PQ17430

VOLKSWAGEN



**15-190 WORKER****CUMMINS INTERACT 5.9 DIESEL (EURO III)****2011**

TENSOR-MOTOR	38584
BANDA-ALT-DH-VENT	K080635
TERMOSTATO-180°	33956

2010

TENSOR-MOTOR	38584
BANDA-ALT-DH-VENT	K080635
TERMOSTATO-180°	33956

2009

TENSOR-MOTOR	38584
BANDA-ALT-DH-VENT	K080635
TERMOSTATO-180°	33956

2008

TENSOR-MOTOR	38584
BANDA-ALT-DH-VENT	K080635
TERMOSTATO-180°	33956

2007

TENSOR-MOTOR	38584
BANDA-ALT-DH-VENT	K080635
TERMOSTATO-180°	33956

2006

TENSOR-MOTOR	38584
BANDA-ALT-DH-VENT	K080635
TERMOSTATO-180°	33956

2005

TENSOR-MOTOR	38584
BANDA-ALT-DH-VENT	K080635
TERMOSTATO-180°	33956

17-210 VOLKSBUS**MWM de 6.2 DIESEL ELECTRONICO****2011**

TENSOR-MOTOR	38584
BANDA-C/AA	K080708
BANDA-ALT-DH-VENT	K080635
TERMOSTATO-180°	33956

2010

TENSOR-MOTOR	38584
BANDA-C/AA	K080708
BANDA-ALT-DH-VENT	K080635
TERMOSTATO-180°	33956

2009

TENSOR-MOTOR 38584

BANDA-C/AA K080708

BANDA-ALT-DH-VENT K080635

TERMOSTATO-180° 33956

2008

TENSOR-MOTOR 38584

BANDA-C/AA K080708

BANDA-ALT-DH-VENT K080635

TERMOSTATO-180° 33956

2007

TENSOR-MOTOR 38584

BANDA-C/AA K080708

BANDA-ALT-DH-VENT K080635

TERMOSTATO-180° 33956

2006

TENSOR-MOTOR 38584

BANDA-C/AA K080708

BANDA-ALT-DH-VENT K080635

TERMOSTATO-180° 33956

2005

TENSOR-MOTOR 38584

BANDA-C/AA K080708

BANDA-ALT-DH-VENT K080635

TERMOSTATO-180° 33956

17-250 WORKER**CUMMINS INTERACT 5.9 DIESEL (EURO III)****2011**

TENSOR-MOTOR 38584

BANDA-ALT-DH-VENT K080635

TERMOSTATO-180° 33956

2010

TENSOR-MOTOR 38584

BANDA-ALT-DH-VENT K080635

TERMOSTATO-180° 33956

2009

TENSOR-MOTOR 38584

BANDA-ALT-DH-VENT K080635

TERMOSTATO-180° 33956

2008

TENSOR-MOTOR 38584

BANDA-ALT-DH-VENT K080635

TERMOSTATO-180° 33956

2007



TENSOR-MOTOR	38584	BANDA-C/AA	K080708
BANDA-ALT-DH-VENT	K080635	BANDA-ALT-DH-VENT	K080635
TERMOSTATO-180°	33956	TERMOSTATO-180°	33956
2006		2006	
TENSOR-MOTOR	38584	TENSOR-MOTOR	38584
BANDA-ALT-DH-VENT	K080635	BANDA-C/AA	K080708
TERMOSTATO-180°	33956	BANDA-ALT-DH-VENT	K080635
2005		TERMOSTATO-180°	33956
TENSOR-MOTOR	38584	2005	
BANDA-ALT-DH-VENT	K080635	TENSOR-MOTOR	38584
TERMOSTATO-180°	33956	BANDA-C/AA	K080708
17-280 CONSTELLATION		BANDA-ALT-DH-VENT	K080635
MAN D0836 6.8L		TERMOSTATO-180°	33956
2014		24-280 CONSTELLATION	
BANDA-MOTOR	K080505	MAN D0836 6.8L	
2013		2014	
BANDA-MOTOR	K080505	BANDA-MOTOR	K080505
2012		2013	
BANDA-MOTOR	K080505	BANDA-MOTOR	K080505
24-250 WORKER		2012	
CUMMINS INTERACT 5.9 DIESEL (EURO III)		BANDA-MOTOR	K080505
2011		8-150 VOLKSBUS	
TENSOR-MOTOR	38584	MAN D0834 4.6L	
BANDA-C/AA	K080708	2014	
BANDA-ALT-DH-VENT	K080635	BANDA-MOTOR	K080505
TERMOSTATO-180°	33956	2013	
2010		BANDA-MOTOR	K080505
TENSOR-MOTOR	38584	2012	
BANDA-C/AA	K080708	BANDA-MOTOR	K080505
BANDA-ALT-DH-VENT	K080635	CUMMINS INTERACT 3.9 DIESEL (EURO III)	
TERMOSTATO-180°	33956	2011	
2009		BANDA-ALT-DH-VENT	K080635
TENSOR-MOTOR	38584	TENSOR-ALT-DH-VENT	38584
BANDA-C/AA	K080708	TERMOSTATO-180°	33956
BANDA-ALT-DH-VENT	K080635	2010	
TERMOSTATO-180°	33956	BANDA-ALT-DH-VENT	K080635
2008		TENSOR-ALT-DH-VENT	38584
TENSOR-MOTOR	38584	TERMOSTATO-180°	33956
BANDA-C/AA	K080708	2009	
BANDA-ALT-DH-VENT	K080635	BANDA-ALT-DH-VENT	K080635
TERMOSTATO-180°	33956	TENSOR-ALT-DH-VENT	38584
2007		TERMOSTATO-180°	33956
TENSOR-MOTOR	38584	2008	
		BANDA-ALT-DH-VENT	K080635



MASTER SERVICIO PESADO 2014

VOLKSWAGEN

8-150 VOLKSBUS

SENSOR-ALT-DH-VENT 38584
 TERMOSTATO-180° 33956

2007

TENSOR-MOTOR 38584
 BANDA-ALT-DH-VENT K080635
 TERMOSTATO-180° 33956

2006

TENSOR-MOTOR 38584
 BANDA-ALT-DH-VENT K080635
 TERMOSTATO-180° 33956

2005

TENSOR-MOTOR 38584
 BANDA-ALT-DH-VENT K080635
 TERMOSTATO-180° 33956

8-150 WORKER

MAN D0834 4.6L

2014
 BANDA-MOTOR K080505

2013

BANDA-MOTOR K080505

2012

BANDA-MOTOR K080505

CUMMINS INTERACT 3.9 DIESEL (EURO III)

2011
 TENSOR-MOTOR 38584
 BANDA-ALT-DH-VENT K080635
 TERMOSTATO-180° 33956

2010

TENSOR-MOTOR 38584
 BANDA-ALT-DH-VENT K080635
 TERMOSTATO-180° 33956

2009

TENSOR-MOTOR 38584
 BANDA-ALT-DH-VENT K080635
 TERMOSTATO-180° 33956

2008

TENSOR-MOTOR 38584
 BANDA-ALT-DH-VENT K080635
 TERMOSTATO-180° 33956

2007

TENSOR-MOTOR 38584
 BANDA-ALT-DH-VENT K080635
 TERMOSTATO-180° 33956

2006

TENSOR-MOTOR 38584
 BANDA-ALT-DH-VENT K080635
 TERMOSTATO-180° 33956

2005

TENSOR-MOTOR 38584
 BANDA-ALT-DH-VENT K080635
 TERMOSTATO-180° 33956

9-150 VOLKSBUS

MAN D0834 4.6L

2014
 BANDA-MOTOR K080505

2013

BANDA-MOTOR K080505

2012

BANDA-MOTOR K080505

9-150 WORKER

MAN D0834 4.6L

2014
 BANDA-MOTOR K080505

2013

BANDA-MOTOR K080505

2012

BANDA-MOTOR K080505

VOLVO



7350

D7C

2002
 BANDA-VENT 2/A78
 BANDA-MOTOR PQ17500
 BANDA-COMPRESOR 2/AX34
 BANDA-COMPRESOR 2/BX92
 BANDA-ALT 6463 GS
 BANDA-ALT PQ17510

B7R

2003
 BANDA-VENT 2/BX76
 BANDA-MOTOR 2/9510PB
 BANDA-COMPRESOR 2/BX97
 BANDA-ALT-COMPRESOR 2/AX41
 BANDA-ALT 2/9476PB



7550

7550

2006

MANGUERA SILICÓN-CON ANILLOS	SIH400096A
BANDA-COMPRESOR	BX88
TENSOR-COMPRESOR	38531
BANDA-BA-VENT-TEMPLADOR	AX85
BANDA-BA-TEMPLADOR	K080427
BANDA-ALT-COMPRESOR	AX36
BANDA-ALT1-ALT2	K080415
MANGUERA DE ENFRIAMIENTO-	24832
MANGUERA DE ENFRIAMIENTO-	24838

2005

MANGUERA SILICÓN-CON ANILLOS	SIH400096A
BANDA-COMPRESOR	BX88
TENSOR-COMPRESOR	38531
BANDA-BA-VENT-TEMPLADOR	AX85
BANDA-BA-TEMPLADOR	K080427
BANDA-ALT-COMPRESOR	AX36
BANDA-ALT1-ALT2	K080415
MANGUERA DE ENFRIAMIENTO-	24832
MANGUERA DE ENFRIAMIENTO-	24838

2004

MANGUERA SILICÓN-CON ANILLOS	SIH400096A
BANDA-COMPRESOR	BX88
TENSOR-COMPRESOR	38531
BANDA-BA-VENT-TEMPLADOR	AX85
BANDA-BA-TEMPLADOR	K080427
BANDA-ALT-COMPRESOR	AX36
BANDA-ALT1-ALT2	K080415
MANGUERA DE ENFRIAMIENTO-	24832
MANGUERA DE ENFRIAMIENTO-	24838

2003

MANGUERA SILICÓN-CON ANILLOS	SIH400096A
BANDA-COMPRESOR	BX88
TENSOR-COMPRESOR	38531
BANDA-BA-VENT-TEMPLADOR	AX85
BANDA-BA-TEMPLADOR	K080427
BANDA-ALT-COMPRESOR	AX36
BANDA-ALT1-ALT2	K080415
MANGUERA DE ENFRIAMIENTO-	24832
MANGUERA DE ENFRIAMIENTO-	24838

2002

MANGUERA SILICÓN-CON ANILLOS	SIH400096A
BANDA-COMPRESOR	BX88
TENSOR-COMPRESOR	38531
BANDA-BA-VENT-TEMPLADOR	AX85
BANDA-BA-TEMPLADOR	K080427
BANDA-ALT-COMPRESOR	AX36
BANDA-ALT1-ALT2	K080415
MANGUERA DE ENFRIAMIENTO-	24832
MANGUERA DE ENFRIAMIENTO-	24838

2001

MANGUERA SILICÓN-CON ANILLOS	SIH400096A
BANDA-COMPRESOR	BX88
TENSOR-COMPRESOR	38531
BANDA-BA-VENT-TEMPLADOR	AX85
BANDA-BA-TEMPLADOR	K080427
BANDA-ALT-COMPRESOR	AX36
BANDA-ALT1-ALT2	K080415
MANGUERA DE ENFRIAMIENTO-	24832
MANGUERA DE ENFRIAMIENTO-	24838

7550 FL

B12

2008

MANGUERA SILICÓN-CON ANILLOS	SIH400096A
BANDA-COMPRESOR	BX92
TENSOR-COMPRESOR	38531
BANDA-BA-VENT-TEMPLADOR	AX86
BANDA-BA-TEMPLADOR	K080427
BANDA-ALT-COMPRESOR	AX36
BANDA-ALT1-ALT2	K080415
MANGUERA DE ENFRIAMIENTO-	24832
MANGUERA DE ENFRIAMIENTO-	24838

2007

MANGUERA SILICÓN-CON ANILLOS	SIH400096A
BANDA-COMPRESOR	BX92
TENSOR-COMPRESOR	38531
BANDA-BA-VENT-TEMPLADOR	AX86
BANDA-BA-TEMPLADOR	K080427
BANDA-ALT-COMPRESOR	AX36
BANDA-ALT1-ALT2	K080415
MANGUERA DE ENFRIAMIENTO-	24832
MANGUERA DE ENFRIAMIENTO-	24838

2006

MANGUERA SILICÓN-CON ANILLOS	SIH400096A
------------------------------	------------



MASTER SERVICIO PESADO 2014

VOLVO

7550 FL

BANDA-COMPRESOR	BX92	BANDA-BA-VENT-TEMPLADOR	AX86
TENSOR-COMPRESOR	38531	BANDA-BA-TEMPLADOR	K080427
BANDA-BA-VENT-TEMPLADOR	AX86	BANDA-ALT-COMPRESOR	AX36
BANDA-BA-TEMPLADOR	K080427	BANDA-ALT1-ALT2	K080415
BANDA-ALT-COMPRESOR	AX36	MANGUERA DE ENFRIAMIENTO-	24832
BANDA-ALT1-ALT2	K080415	MANGUERA DE ENFRIAMIENTO-	24838
MANGUERA DE ENFRIAMIENTO-	24832	2005	
MANGUERA DE ENFRIAMIENTO-	24838	MANGUERA SILICÓN-CON ANILLOS	SIH400096A
2005		BANDA-COMPRESOR	BX92
MANGUERA SILICÓN-CON ANILLOS	SIH400096A	TENSOR-COMPRESOR	38531
BANDA-COMPRESOR	BX92	BANDA-BA-VENT-TEMPLADOR	AX86
TENSOR-COMPRESOR	38531	BANDA-BA-TEMPLADOR	K080427
BANDA-BA-VENT-TEMPLADOR	AX86	BANDA-ALT-COMPRESOR	AX36
BANDA-BA-TEMPLADOR	K080427	BANDA-ALT1-ALT2	K080415
BANDA-ALT-COMPRESOR	AX36	MANGUERA DE ENFRIAMIENTO-	24832
BANDA-ALT1-ALT2	K080415	MANGUERA DE ENFRIAMIENTO-	24838
MANGUERA DE ENFRIAMIENTO-	24832	2004	
MANGUERA DE ENFRIAMIENTO-	24838	MANGUERA SILICÓN-CON ANILLOS	SIH400096A
9300			
B9			
2004			
BANDA-MOTOR	K050586	BANDA-BA-VENT-TEMPLADOR	AX86
BANDA-COMPRESOR	BX96	BANDA-BA-TEMPLADOR	K080427
BANDA-C/AA	K080550	BANDA-ALT-COMPRESOR	AX36
9700			
B13			
2014			
BANDA-	K080586	BANDA-BA-VENT-TEMPLADOR	AX86
BANDA-	K100594	BANDA-BA-TEMPLADOR	K080427
BANDA-	K100817	BANDA-ALT-COMPRESOR	AX36
2013			
BANDA-	K080586	BANDA-ALT1-ALT2	K080415
BANDA-	K100594	MANGUERA DE ENFRIAMIENTO-	24832
BANDA-	K100817	MANGUERA DE ENFRIAMIENTO-	24838
2012			
BANDA-	K080586	2003	
BANDA-	K100594	MANGUERA SILICÓN-CON ANILLOS	SIH400096A
BANDA-	K100817	BANDA-COMPRESOR	BX92
B12			
2006			
MANGUERA SILICÓN-CON ANILLOS	SIH400096A	TENSOR-COMPRESOR	38531
BANDA-COMPRESOR	BX92	BANDA-BA-VENT-TEMPLADOR	AX86
TENSOR-COMPRESOR	38531	BANDA-BA-TEMPLADOR	K080427
		BANDA-ALT-COMPRESOR	AX36



MASTER SERVICIO PESADO 2014

VOLVO

9700

BANDA-ALT1-ALT2	K080415	BANDA-COMPRESOR	BX94
MANGUERA DE ENFRIAMIENTO-	24832	BANDA-ALT1-ALT2-ALT3-TEMPLADOR	K080745
MANGUERA DE ENFRIAMIENTO-	24838	MANGUERA DE ENFRIAMIENTO-	24832
9700 FL		MANGUERA DE ENFRIAMIENTO-	24838
B12		2005	
2011		TENSOR-MOTOR	38607
TENSOR-MOTOR	38607	MANGUERA SILICÓN-CON ANILLOS	SIH400096A
MANGUERA SILICÓN-CON ANILLOS	SIH400096A	BANDA-COMPRESOR	BX94
BANDA-COMPRESOR	BX94	BANDA-ALT1-ALT2-ALT3-TEMPLADOR	K080745
BANDA-ALT1-ALT2-ALT3-TEMPLADOR	K080745	MANGUERA DE ENFRIAMIENTO-	24832
MANGUERA DE ENFRIAMIENTO-	24832	MANGUERA DE ENFRIAMIENTO-	24838
MANGUERA DE ENFRIAMIENTO-	24838	AUTOCAR	
2010		DETROIT DIESEL 6 CIL, 12.7 L DIESEL	
TENSOR-MOTOR	38607	2001	
MANGUERA SILICÓN-CON ANILLOS	SIH400096A	BANDA-VENT	9625
BANDA-COMPRESOR	BX94	MANGUERA SILICÓN-TUBO A RAD.	SIH250363C
BANDA-ALT1-ALT2-ALT3-TEMPLADOR	K080745	MANGUERA SILICÓN-TUBO A RAD.	SIH300363C
MANGUERA DE ENFRIAMIENTO-	24832	BANDA-TOMA DE FUERZA-ALT-AA	9490
MANGUERA DE ENFRIAMIENTO-	24838	MANGUERA SILICÓN-MOTOR A TUBO	SIH250363C
2009		MANGUERA SILICÓN-MOTOR A TUBO	SIH300363C
TENSOR-MOTOR	38607	TERMOSTATO-190°	33599
MANGUERA SILICÓN-CON ANILLOS	SIH400096A	2000	
BANDA-COMPRESOR	BX94	BANDA-VENT	9625
BANDA-ALT1-ALT2-ALT3-TEMPLADOR	K080745	MANGUERA SILICÓN-TUBO A RAD.	SIH250363C
MANGUERA DE ENFRIAMIENTO-	24832	MANGUERA SILICÓN-TUBO A RAD.	SIH300363C
MANGUERA DE ENFRIAMIENTO-	24838	BANDA-TOMA DE FUERZA-ALT-AA	9490
2008		MANGUERA SILICÓN-MOTOR A TUBO	SIH250363C
TENSOR-MOTOR	38607	MANGUERA SILICÓN-MOTOR A TUBO	SIH300363C
MANGUERA SILICÓN-CON ANILLOS	SIH400096A	TERMOSTATO-190°	33599
BANDA-COMPRESOR	BX94	1999	
BANDA-ALT1-ALT2-ALT3-TEMPLADOR	K080745	MANGUERA SILICÓN-TUBO A RAD.	SIH250363C
MANGUERA DE ENFRIAMIENTO-	24832	BANDA-TOMA DE FUERZA-AA	9490
MANGUERA DE ENFRIAMIENTO-	24838	MANGUERA INFERIOR-RAD. A ENFRIADOR	21042
2007		MANGUERA SILICÓN-MOTOR A TUBO	SIH250363C
TENSOR-MOTOR	38607	MANGUERA SILICÓN-MOTOR A TUBO	SIH300363C
MANGUERA SILICÓN-CON ANILLOS	SIH400096A	BANDA-ALT-VENT	9625
BANDA-COMPRESOR	BX94	TERMOSTATO-190°	33599
BANDA-ALT1-ALT2-ALT3-TEMPLADOR	K080745	1998	
MANGUERA DE ENFRIAMIENTO-	24832	BANDA-TOMA DE FUERZA-AA	9555
MANGUERA DE ENFRIAMIENTO-	24838	BANDA-ALT-VENT	K080670
2006		TENSOR-ALT-VENT	38505
TENSOR-MOTOR	38607	TERMOSTATO-190°	33599
MANGUERA SILICÓN-CON ANILLOS	SIH400096A	POLEA DEL TENSOR-	36091



1997			BANDA-TOMA DE FUERZA-AA	9370
TERMOSTATO-190°	33599		MANGUERA SILICÓN-MOTOR A TUBO	SIH250363C
1996			BANDA-ALT	9451
TERMOSTATO-190°	33599		TERMOSTATO-190°	33579
DETROIT DIESEL 6 CIL, 11.1 L DIESEL			TERMOSTATO-180°	33576
2001			TERMOSTATO-180°	33578
BANDA-VENT	9625		TERMOSTATO-170°	33577
MANGUERA SILICÓN-TUBO A RAD.	SIH250363C		2000	
MANGUERA SILICÓN-TUBO A RAD.	SIH300363C		MANGUERA SILICÓN-TUBO A RAD.	SIH250363C
BANDA-TOMA DE FUERZA-ALT-AA	9490		BANDA-TOMA DE FUERZA-VENT	K080465
MANGUERA SILICÓN-MOTOR A TUBO	SIH250363C		BANDA-TOMA DE FUERZA-BA	K060425
MANGUERA SILICÓN-MOTOR A TUBO	SIH300363C		BANDA-TOMA DE FUERZA-AA	9370
TERMOSTATO-190°	33599		MANGUERA SILICÓN-MOTOR A TUBO	SIH250363C
2000			BANDA-ALT	9451
BANDA-VENT	9625		TERMOSTATO-190°	33579
MANGUERA SILICÓN-TUBO A RAD.	SIH250363C		TERMOSTATO-180°	33576
MANGUERA SILICÓN-TUBO A RAD.	SIH300363C		TERMOSTATO-180°	33578
BANDA-TOMA DE FUERZA-ALT-AA	9490		TERMOSTATO-170°	33577
MANGUERA SILICÓN-MOTOR A TUBO	SIH250363C		1999	
MANGUERA SILICÓN-MOTOR A TUBO	SIH300363C		MANGUERA SILICÓN-TUBO A RAD.	SIH250363C
TERMOSTATO-190°	33599		BANDA-TOMA DE FUERZA-VENT	K080465
1999			BANDA-TOMA DE FUERZA-BA	K060425
MANGUERA SILICÓN-TUBO A RAD.	SIH250363C		BANDA-TOMA DE FUERZA-AA	9370
BANDA-TOMA DE FUERZA-AA	9490		MANGUERA SILICÓN-MOTOR A TUBO	SIH250363C
MANGUERA INFERIOR-RAD. A ENFRIADOR	21042		BANDA-ALT	9451
MANGUERA SILICÓN-MOTOR A TUBO	SIH250363C		TERMOSTATO-190°	33579
MANGUERA SILICÓN-MOTOR A TUBO	SIH300363C		TERMOSTATO-180°	33576
BANDA-ALT-VENT	9625		TERMOSTATO-180°	33578
TERMOSTATO-190°	33599		TERMOSTATO-170°	33577
1998			1998	
BANDA-TOMA DE FUERZA-AA	9555		TERMOSTATO-190°	33579
BANDA-ALT-VENT	K080670		TERMOSTATO-180°	33576
SENSOR-ALT-VENT	38505		TERMOSTATO-180°	33578
TERMOSTATO-190°	33599		TERMOSTATO-170°	33577
POLEA DEL TENSOR-	36091		1997	
1997			TERMOSTATO-190°	33579
TERMOSTATO-190°	33599		TERMOSTATO-180°	33576
1996			TERMOSTATO-180°	33578
TERMOSTATO-190°	33599		TERMOSTATO-170°	33577
CUMMINS N14 DIESEL			1996	
2001			TERMOSTATO-190°	33579
MANGUERA SILICÓN-TUBO A RAD.	SIH250363C		TERMOSTATO-180°	33576
BANDA-TOMA DE FUERZA-VENT	K080465		TERMOSTATO-180°	33578
BANDA-TOMA DE FUERZA-BA	K060425		TERMOSTATO-180°	33578



TERMOSTATO-170°	33577	BANDA-VENT	K080645
CUMMINS M11 DIESEL		MANGUERA SILICÓN-TUBO A RAD.	SIH250363C
1998		BANDA-TOMA DE FUERZA-ALT	K050345
TERMOSTATO-190°	33579	BANDA-TOMA DE FUERZA-AA	9530
TERMOSTATO-180°	33576	MANGUERA SILICÓN-MOTOR A TUBO	SIH250363C
TERMOSTATO-180°	33578	1999	
TERMOSTATO-170°	33577	BANDA-VENT	K080610
1997		BANDA-ALT	K050345
TERMOSTATO-190°	33579	BANDA-	9530
TERMOSTATO-180°	33576	CATERPILLAR 3406 DIESEL	
TERMOSTATO-180°	33578	1999	
TERMOSTATO-170°	33577	TERMOSTATO-190°	33579
1996		TERMOSTATO-180°	33576
TERMOSTATO-190°	33579	TERMOSTATO-180°	33578
TERMOSTATO-180°	33576	TERMOSTATO-170°	33577
TERMOSTATO-180°	33578	1998	
TERMOSTATO-170°	33577	TERMOSTATO-190°	33579
CUMMINS L10 DIESEL		TERMOSTATO-180°	33576
1998		TERMOSTATO-180°	33578
TERMOSTATO-190°	33579	TERMOSTATO-170°	33577
TERMOSTATO-180°	33576	1997	
TERMOSTATO-180°	33578	TERMOSTATO-190°	33579
TERMOSTATO-175°	33960	TERMOSTATO-180°	33576
TERMOSTATO-170°	33577	TERMOSTATO-180°	33578
1997		TERMOSTATO-170°	33577
TERMOSTATO-190°	33579	1996	
TERMOSTATO-180°	33576	TERMOSTATO-190°	33579
TERMOSTATO-180°	33578	TERMOSTATO-180°	33576
TERMOSTATO-175°	33960	TERMOSTATO-180°	33578
TERMOSTATO-170°	33577	TERMOSTATO-170°	33577
1996		CATERPILLAR 3306 DIESEL	
TERMOSTATO-190°	33579	1999	
TERMOSTATO-180°	33576	TERMOSTATO-175°	33549
TERMOSTATO-180°	33578	1998	
TERMOSTATO-175°	33960	TERMOSTATO-175°	33549
TERMOSTATO-170°	33577	1997	
CUMMINS ISM DIESEL		TERMOSTATO-175°	33549
2001		1996	
BANDA-VENT	K080645	TERMOSTATO-175°	33549
MANGUERA SILICÓN-TUBO A RAD.	SIH250363C	C11R URBANO	
BANDA-TOMA DE FUERZA-ALT	K050345	CUMMINS ISB DIESEL	
BANDA-TOMA DE FUERZA-AA	9530	2004	
MANGUERA SILICÓN-MOTOR A TUBO	SIH250363C	BANDA-VENT	AX50
2000		BANDA-MOTOR	AX55

BANDA-MOTOR **K080790****FE SERIES****VOLVO VE D7 DIESEL****1995**BANDA-ALT-VENT **7460**BANDA-ALT **2/9500PB**BANDA-ALT **9500**BANDA- **9500****CATERPILLAR 3116 DIESEL****1998**TERMOSTATO-190° **33969**TERMOSTATO-180° **33968****1997**TERMOSTATO-190° **33969**TERMOSTATO-180° **33968****1996**TERMOSTATO-190° **33969**TERMOSTATO-180° **33968****1995**TERMOSTATO-190° **33969**TERMOSTATO-180° **33968****VHD****VOLVO VE D12 DIESEL****2009**BANDA-VENT **K100572**TENSOR-VENT **36286**TENSOR-VENT **38581**BANDA-TOMA DE FUERZA-ALT-AA **K080565**TENSOR-ALT-AA **38585****2008**BANDA-VENT **K100572**TENSOR-VENT **36286**TENSOR-VENT **38581**BANDA-TOMA DE FUERZA-ALT-AA **K080565**TENSOR-ALT-AA **38585****2007**BANDA-VENT **K100572**TENSOR-VENT **36286**TENSOR-VENT **38581**BANDA-TOMA DE FUERZA-ALT-AA **K080565**TENSOR-ALT-AA **38585****2006**BANDA-VENT **K100579**POLEA-VENT **36286**TENSOR-VENT **38581**BANDA-ALT-AA **K080385**TENSOR-ALT-AA **38585****2005**BANDA-VENT **K100579**POLEA-VENT **36286**TENSOR-VENT **38581**BANDA-ALT-AA **K080385**TENSOR-ALT-AA **38585****2004**BANDA-VENT **K100437**TENSOR-VENT **38581**BANDA-TOMA DE FUERZA-ALT-AA **K080375**MANGUERA INFERIOR-MOTOR A RAD. **22710**MANGUERA SUPERIOR-MOTOR A RAD. **22709****2003**BANDA-VENT **K100437**TENSOR-VENT **38581**BANDA-TOMA DE FUERZA-ALT-AA **K080375**MANGUERA INFERIOR-MOTOR A RAD. **22710**MANGUERA SUPERIOR-MOTOR A RAD. **22709****2002**BANDA-VENT **K100579**TENSOR-VENT **38547**BANDA-TOMA DE FUERZA-ALT-AA **K080558**MANGUERA INFERIOR-MOTOR A RAD. **22725**MANGUERA SUPERIOR-MOTOR A RAD. **22724****2001**BANDA-VENT **K100579**TENSOR-VENT **38547**BANDA-TOMA DE FUERZA-ALT-AA **K080558**MANGUERA INFERIOR-MOTOR A RAD. **22725**MANGUERA SUPERIOR-MOTOR A RAD. **22724****VOLVO VE 12 DIESEL****2002**BANDA-VENT **K100579**TENSOR-VENT **38581**BANDA-TOMA DE FUERZA-ALT-AA **K080382**MANGUERA INFERIOR-MOTOR A RAD. **22725**MANGUERA SUPERIOR-MOTOR A RAD. **22724****DETROIT DIESEL SERIE 60****2001**



MASTER SERVICIO PESADO 2014

VOLVO

VHD

TERMOSTATO-190°	33599	TAPÓN DE RADIADOR-(20 LBS) SIN PALANCA	31335
CUMMINS N14 DIESEL		2006	
2001		TENSOR-VENT	38581
TERMOSTATO-190°	33579	BANDA-BA-VENT	K100554
TERMOSTATO-180°	33576	BANDA-ALT-AA	K080550
TERMOSTATO-180°	33578	TENSOR-ALT-AA	38585
TERMOSTATO-170°	33577	TAPÓN DE RADIADOR-(20 LBS) SIN PALANCA	31335
CUMMINS ISM DIESEL		VOLVO VE D12 DIESEL	
2003		2008	
BANDA-TOMA DE FUERZA-AA	K060532	BANDA-VENT	K100582
TENSOR-TOMA DE FUERZA-AA	38607	POLEA-VENT	36286
MANGUERA INFERIOR-MOTOR A RAD.	22712	TENSOR-VENT	38581
MANGUERA SUPERIOR-MOTOR A RAD.	22711	BANDA-ALT-AA	K080385
BANDA-ALT-VENT	K100891	TENSOR-ALT-AA	38585
POLEA-ALT-VENT	36092	TAPÓN DE RADIADOR-(20 LBS) SIN PALANCA	31335
TENSOR-ALT-VENT	38539	MANGUERA INFERIOR-	22710
2002		MANGUERA SUPERIOR-	22709
BANDA-TOMA DE FUERZA-AA	K060532	2007	
TENSOR-TOMA DE FUERZA-AA	38607	BANDA-VENT	K100582
MANGUERA INFERIOR-MOTOR A RAD.	22712	POLEA-VENT	36286
MANGUERA SUPERIOR-MOTOR A RAD.	22711	TENSOR-VENT	38581
BANDA-ALT-VENT	K100891	BANDA-ALT-AA	K080385
POLEA-ALT-VENT	36092	TENSOR-ALT-AA	38585
TENSOR-ALT-VENT	38539	TAPÓN DE RADIADOR-(20 LBS) SIN PALANCA	31335
VNL		MANGUERA INFERIOR-	22710
VOLVO VE D16 DIESEL		MANGUERA SUPERIOR-	22709
2009		2006	
TENSOR-VENT	38581	BANDA-VENT	K100582
BANDA-BA-VENT	K100578	POLEA-VENT	36286
BANDA-ALT-AA	K080550	TENSOR-VENT	38581
TENSOR-ALT-AA	38585	BANDA-ALT-AA	K080385
TAPÓN DE RADIADOR-(20 LBS) SIN PALANCA	31335	TENSOR-ALT-AA	38585
2008		TAPÓN DE RADIADOR-(20 LBS) SIN PALANCA	31335
TENSOR-VENT	38581	MANGUERA INFERIOR-	22710
BANDA-BA-VENT	K100554	MANGUERA SUPERIOR-	22709
BANDA-ALT-AA	K080550	2005	
TENSOR-ALT-AA	38585	BANDA-VENT	K100582
TAPÓN DE RADIADOR-(20 LBS) SIN PALANCA	31335	POLEA-VENT	36286
2007		TENSOR-VENT	38581
TENSOR-VENT	38581	BANDA-ALT-AA	K080385
BANDA-BA-VENT	K100554	TENSOR-ALT-AA	38585
BANDA-ALT-AA	K080550	TAPÓN DE RADIADOR-(20 LBS) SIN PALANCA	31335
TENSOR-ALT-AA	38585	MANGUERA INFERIOR-	22710



MASTER SERVICIO PESADO 2014

VOLVO

VNL

MANGUERA SUPERIOR-	22709	MANGUERA SUPERIOR-MOTOR A RAD.	22709
2004		TAPÓN DE RADIADOR-(20 LBS) SIN PALANCA	31335
BANDA-VENT	K100582	1998	
POLEA-VENT	36286	BANDA-VENT	K100437
TENSOR-VENT	38581	TENSOR-VENT	38547
BANDA-ALT-AA	K080385	BANDA-TOMA DE FUERZA-ALT-AA	K080375
TENSOR-ALT-AA	38585	MANGUERA INFERIOR-MOTOR A RAD.	22710
TAPÓN DE RADIADOR-(20 LBS) SIN PALANCA	31335	MANGUERA SUPERIOR-MOTOR A RAD.	22709
MANGUERA INFERIOR-	22710	TAPÓN DE RADIADOR-(20 LBS) SIN PALANCA	31335
MANGUERA SUPERIOR-	22709	VOLVO VE 12 DIESEL	
2003		2000	
BANDA-VENT	K100437	BANDA-TOMA DE FUERZA-VENT	K100437
TENSOR-VENT	38547	BANDA-TOMA DE FUERZA-ALT-AA	K080375
BANDA-TOMA DE FUERZA-ALT-AA	K080375	MANGUERA INFERIOR-MOTOR A RAD.	22710
MANGUERA INFERIOR-MOTOR A RAD.	22710	MANGUERA SUPERIOR-MOTOR A RAD.	22709
MANGUERA SUPERIOR-MOTOR A RAD.	22709	1999	
TAPÓN DE RADIADOR-(20 LBS) SIN PALANCA	31335	BANDA-TOMA DE FUERZA-VENT	K080400
2002		BANDA-TOMA DE FUERZA-ALT-AA	K080408
BANDA-VENT	K100437	VOLVO D16 DIESEL	
TENSOR-VENT	38547	2013	
BANDA-TOMA DE FUERZA-ALT-AA	K080375	TENSOR-VENT	38581
MANGUERA INFERIOR-MOTOR A RAD.	22710	MANGUERA SUPERIOR-MOTOR A TUBO	21891
MANGUERA SUPERIOR-MOTOR A RAD.	22709	BANDA-BA-VENT	K100578
TAPÓN DE RADIADOR-(20 LBS) SIN PALANCA	31335	BANDA-ALT-AA	K080550
2001		TENSOR-ALT-AA	38585
BANDA-VENT	K100437	TAPÓN DE RADIADOR-(20 LBS) SIN PALANCA	31335
TENSOR-VENT	38547	2012	
BANDA-TOMA DE FUERZA-ALT-AA	K080375	TENSOR-VENT	38581
MANGUERA INFERIOR-MOTOR A RAD.	22710	MANGUERA SUPERIOR-MOTOR A TUBO	21891
MANGUERA SUPERIOR-MOTOR A RAD.	22709	BANDA-BA-VENT	K100578
TAPÓN DE RADIADOR-(20 LBS) SIN PALANCA	31335	BANDA-ALT-AA	K080550
2000		TENSOR-ALT-AA	38585
BANDA-VENT	K100437	TAPÓN DE RADIADOR-(20 LBS) SIN PALANCA	31335
TENSOR-VENT	38547	2011	
BANDA-TOMA DE FUERZA-ALT-AA	K080375	TENSOR-VENT	38581
MANGUERA INFERIOR-MOTOR A RAD.	22710	MANGUERA SUPERIOR-MOTOR A TUBO	21891
MANGUERA SUPERIOR-MOTOR A RAD.	22709	BANDA-BA-VENT	K100578
TAPÓN DE RADIADOR-(20 LBS) SIN PALANCA	31335	BANDA-ALT-AA	K080550
1999		TENSOR-ALT-AA	38585
BANDA-VENT	K100437	TAPÓN DE RADIADOR-(20 LBS) SIN PALANCA	31335
TENSOR-VENT	38547	2010	
BANDA-TOMA DE FUERZA-ALT-AA	K080375	TENSOR-VENT	38581
MANGUERA INFERIOR-MOTOR A RAD.	22710	MANGUERA SUPERIOR-MOTOR A TUBO	21891



MASTER SERVICIO PESADO 2014

VOLVO

VNL

BANDA-BA-VENT	K100578	TENSOR-ALT	38671
BANDA-ALT-AA	K080550	TAPÓN DE RADIADOR-(20 LBS) SIN PALANCA	31335
TENSOR-ALT-AA	38585	MANGUERA INFERIOR-	23563
TAPÓN DE RADIADOR-(20 LBS) SIN PALANCA	31335	2011	
2009		BANDA-VENT	K120640
TENSOR-VENT	38581	TENSOR-VENT	38633
MANGUERA SUPERIOR-MOTOR A TUBO	21891	MANGUERA SUPERIOR-TUBO A MOTOR	22714
BANDA-BA-VENT	K100578	MANGUERA SUPERIOR-RAD. A TUBO	23564
BANDA-ALT-AA	K080550	BANDA-ALT-AA	K080630
TENSOR-ALT-AA	38585	TENSOR-ALT	38671
TAPÓN DE RADIADOR-(20 LBS) SIN PALANCA	31335	TAPÓN DE RADIADOR-(20 LBS) SIN PALANCA	31335
2008		MANGUERA INFERIOR-	23563
TENSOR-VENT	38581	2010	
MANGUERA SUPERIOR-MOTOR A TUBO	21891	BANDA-VENT	K120640
BANDA-BA-VENT	K120610	TENSOR-VENT	38633
BANDA-ALT-AA	K080550	MANGUERA SUPERIOR-TUBO A MOTOR	22714
TENSOR-ALT-AA	38585	MANGUERA SUPERIOR-RAD. A TUBO	23564
TAPÓN DE RADIADOR-(20 LBS) SIN PALANCA	31335	BANDA-ALT-AA	K080630
VOLVO D13 DIESEL		TENSOR-ALT	38671
2014		TAPÓN DE RADIADOR-(20 LBS) SIN PALANCA	31335
BANDA-VENT	K120640	MANGUERA INFERIOR-	23563
TENSOR-VENT	38633	2009	
MANGUERA SUPERIOR-TUBO A MOTOR	22714	BANDA-VENT	K120640
MANGUERA SUPERIOR-RAD. A TUBO	23564	TENSOR-VENT	38633
BANDA-ALT-AA	K080630	MANGUERA SUPERIOR-TUBO A MOTOR	22714
TENSOR-ALT	38671	MANGUERA SUPERIOR-RAD. A TUBO	23564
TAPÓN DE RADIADOR-(20 LBS) SIN PALANCA	31335	BANDA-ALT-AA	K080630
MANGUERA INFERIOR-	23563	TENSOR-ALT	38671
2013		TAPÓN DE RADIADOR-(20 LBS) SIN PALANCA	31335
BANDA-VENT	K120640	MANGUERA INFERIOR-	23563
TENSOR-VENT	38633	2008	
MANGUERA SUPERIOR-TUBO A MOTOR	22714	BANDA-VENT	K120640
MANGUERA SUPERIOR-RAD. A TUBO	23564	TENSOR-VENT	38633
BANDA-ALT-AA	K080630	MANGUERA SUPERIOR-TUBO A MOTOR	22714
TENSOR-ALT	38671	MANGUERA SUPERIOR-RAD. A TUBO	23564
TAPÓN DE RADIADOR-(20 LBS) SIN PALANCA	31335	BANDA-ALT-AA	K080630
MANGUERA INFERIOR-	23563	TENSOR-ALT	38671
2012		TAPÓN DE RADIADOR-(20 LBS) SIN PALANCA	31335
BANDA-VENT	K120640	MANGUERA INFERIOR-	23563
TENSOR-VENT	38633	DETROIT DIESEL 6 CIL, 12.7 L DIESEL	
MANGUERA SUPERIOR-TUBO A MOTOR	22714	2001	
MANGUERA SUPERIOR-RAD. A TUBO	23564	BANDA-VENT-AA	9555
BANDA-ALT-AA	K080630	MANGUERA SILICÓN-TUBO A RAD.	SIH250363C



MASTER SERVICIO PESADO 2014

VOLVO

VNL

MANGUERA SILICÓN-MOTOR A TUBO	SIH250363C	TENSOR-ALT-VENT	38505
BANDA-ALT-VENT	K080670	TERMOSTATO-190°	33599
TENSOR-ALT-VENT	38505	POLEA DEL TENSOR-	36091
TERMOSTATO-190°	33599	1999	
POLEA DEL TENSOR-	36091	BANDA-VENT-AA	9555
2000		MANGUERA SILICÓN-TUBO A RAD.	SIH250363C
BANDA-VENT-AA	9555	MANGUERA SILICÓN-MOTOR A TUBO	SIH250363C
MANGUERA SILICÓN-TUBO A RAD.	SIH250363C	BANDA-ALT-VENT	K080670
MANGUERA SILICÓN-MOTOR A TUBO	SIH250363C	TENSOR-ALT-VENT	38505
BANDA-ALT-VENT	K080670	TERMOSTATO-190°	33599
TENSOR-ALT-VENT	38505	POLEA DEL TENSOR-	36091
TERMOSTATO-190°	33599	1998	
POLEA DEL TENSOR-	36091	BANDA-VENT-AA	9555
1999		MANGUERA SILICÓN-TUBO A RAD.	SIH250363C
BANDA-VENT-AA	9555	MANGUERA SILICÓN-MOTOR A TUBO	SIH250363C
MANGUERA SILICÓN-TUBO A RAD.	SIH250363C	BANDA-ALT-VENT	K080670
MANGUERA SILICÓN-MOTOR A TUBO	SIH250363C	TENSOR-ALT-VENT	38505
BANDA-ALT-VENT	K080670	TERMOSTATO-190°	33599
TENSOR-ALT-VENT	38505	POLEA DEL TENSOR-	36091
TERMOSTATO-190°	33599	CUMMINS SIGNATURE 600 DIESEL	
POLEA DEL TENSOR-	36091	2003	
1998		BANDA-VENT-C/PURIF DE AIRE	K120842
BANDA-VENT-AA	9555	BANDA-VENT	K100510
MANGUERA SILICÓN-TUBO A RAD.	SIH250363C	POLEA DEL TENSOR-VENT	36092
MANGUERA SILICÓN-MOTOR A TUBO	SIH250363C	TENSOR-VENT	38535
BANDA-ALT-VENT	K080670	BANDA-TOMA DE FUERZA-ALT-AA-C/PURIF DE AIRE	K060637
TENSOR-ALT-VENT	38505	BANDA-TOMA DE FUERZA-ALT-AA	K060685
TERMOSTATO-190°	33599	POLEA DEL TENSOR-TOMA DE FUERZA-ALT-AA	36095
POLEA DEL TENSOR-	36091	TENSOR-TOMA DE FUERZA-ALT-AA	38532
DETROIT DIESEL 6 CIL, 11.1 L DIESEL		MANGUERA SILICÓN-MOTOR A TUBO	SIH250363C
2001		TENSOR-ALT-VENT	38587
BANDA-VENT-AA	9555	CUMMINS N14 DIESEL	
MANGUERA SILICÓN-TUBO A RAD.	SIH250363C	2003	
MANGUERA SILICÓN-MOTOR A TUBO	SIH250363C	BANDA-VENT	K100630
BANDA-ALT-VENT	K080670	POLEA DEL TENSOR-VENT	36098
TENSOR-ALT-VENT	38505	MANGUERA SILICÓN-TUBO A RAD.	SIH250363C
TERMOSTATO-190°	33599	BANDA-TOMA DE FUERZA-BA	K060425
POLEA DEL TENSOR-	36091	BANDA-TOMA DE FUERZA-AA	9370
2000		MANGUERA SILICÓN-MOTOR A TUBO	SIH250363C
BANDA-VENT-AA	9555	BANDA-ALT	K050420
MANGUERA SILICÓN-TUBO A RAD.	SIH250363C	TERMOSTATO-190°	33579
MANGUERA SILICÓN-MOTOR A TUBO	SIH250363C	TERMOSTATO-180°	33576
BANDA-ALT-VENT	K080670	TERMOSTATO-180°	33578



MASTER SERVICIO PESADO 2014

VOLVO

VNL

TERMOSTATO-170°	33577	MANGUERA SILICÓN-TUBO A RAD.	SIH250363C
2002		BANDA-TOMA DE FUERZA-VENT	K080384
BANDA-VENT	K100630	BANDA-TOMA DE FUERZA-BA	K060425
POLEA DEL TENSOR-VENT	36098	BANDA-TOMA DE FUERZA-AA	9370
TENSOR-VENT	38536	MANGUERA SILICÓN-MOTOR A TUBO	SIH250363C
MANGUERA SILICÓN-TUBO A RAD.	SIH250363C	BANDA-ALT	9451
BANDA-TOMA DE FUERZA-BA	K060425	TERMOSTATO-190°	33579
BANDA-TOMA DE FUERZA-AA	9370	TERMOSTATO-180°	33576
MANGUERA SILICÓN-MOTOR A TUBO	SIH250363C	TERMOSTATO-180°	33578
MANGUERA SUPERIOR-MOTOR A RAD.	22726	TERMOSTATO-170°	33577
BANDA-ALT	K050420	1998	
TERMOSTATO-190°	33579	MANGUERA SILICÓN-TUBO A RAD.	SIH250363C
TERMOSTATO-180°	33576	BANDA-TOMA DE FUERZA-VENT	K080384
TERMOSTATO-180°	33578	BANDA-TOMA DE FUERZA-BA	K060425
TERMOSTATO-170°	33577	BANDA-TOMA DE FUERZA-AA	9370
2001		MANGUERA SILICÓN-MOTOR A TUBO	SIH250363C
BANDA-VENT	K100630	BANDA-ALT	9451
POLEA DEL TENSOR-VENT	36098	TERMOSTATO-190°	33579
TENSOR-VENT	38536	TERMOSTATO-180°	33576
MANGUERA SILICÓN-TUBO A RAD.	SIH250363C	TERMOSTATO-180°	33578
BANDA-TOMA DE FUERZA-BA	K060425	TERMOSTATO-170°	33577
BANDA-TOMA DE FUERZA-AA	9370	CUMMINS M11 DIESEL	
MANGUERA SILICÓN-MOTOR A TUBO	SIH250363C	1997	
MANGUERA SUPERIOR-MOTOR A RAD.	22726	BANDA-VENT	K080623
BANDA-ALT	K050420	TERMOSTATO-190°	33579
TERMOSTATO-190°	33579	TERMOSTATO-180°	33576
TERMOSTATO-180°	33576	TERMOSTATO-180°	33578
TERMOSTATO-180°	33578	TERMOSTATO-170°	33577
TERMOSTATO-170°	33577	BANDA-	9540
2000		CUMMINS ISX DIESEL	
BANDA-VENT	K100630	2013	
POLEA DEL TENSOR-VENT	36098	BANDA-TOMA DE FUERZA-AA	K060637
TENSOR-VENT	38536	MANGUERA INFERIOR-RAD. A TUBO	22717
MANGUERA SILICÓN-TUBO A RAD.	SIH250363C	BANDA-ALT-VENT	K120842
BANDA-TOMA DE FUERZA-BA	K060425	POLEA-ALT-VENT	36286
BANDA-TOMA DE FUERZA-AA	9370	POLEA DEL TENSOR-ALT-VENT	36165
MANGUERA SILICÓN-MOTOR A TUBO	SIH250363C	TENSOR-ALT-VENT	38587
BANDA-ALT	K050420	POLEA-AA	36223
TERMOSTATO-190°	33579	TENSOR-AA	38610
TERMOSTATO-180°	33576	TERMOSTATO-190°	34149
TERMOSTATO-180°	33578	TERMOSTATO-180°	34146
TERMOSTATO-170°	33577	TERMOSTATO-180°	34148
1999		BOMBA DE AGUA-	45054HD



MASTER SERVICIO PESADO 2014

VOLVO

VNL

MANGUERA SILICÓN-	SIH275363C	2009	
2012		BANDA-TOMA DE FUERZA-AA	K060637
BANDA-TOMA DE FUERZA-AA	K060637	MANGUERA INFERIOR-RAD. A TUBO	22717
MANGUERA INFERIOR-RAD. A TUBO	22717	BANDA-ALT-VENT	K120842
BANDA-ALT-VENT	K120842	POLEA-ALT-VENT	36286
POLEA-ALT-VENT	36286	POLEA DEL TENSOR-ALT-VENT	36165
POLEA DEL TENSOR-ALT-VENT	36165	TENSOR-ALT-VENT	38587
TENSOR-ALT-VENT	38587	POLEA-AA	36223
POLEA-AA	36223	TENSOR-AA	38610
TENSOR-AA	38610	TERMOSTATO-190°	34149
TERMOSTATO-190°	34149	TERMOSTATO-180°	34146
TERMOSTATO-180°	34146	TERMOSTATO-180°	34148
TERMOSTATO-180°	34148	BOMBA DE AGUA-	45054HD
BOMBA DE AGUA-	45054HD	MANGUERA SILICÓN-	SIH275363C
MANGUERA SILICÓN-	SIH275363C	2008	
2011		BANDA-TOMA DE FUERZA-AA	K060637
BANDA-TOMA DE FUERZA-AA	K060637	MANGUERA INFERIOR-RAD. A TUBO	22717
MANGUERA INFERIOR-RAD. A TUBO	22717	BANDA-ALT-VENT	K120842
BANDA-ALT-VENT	K120842	POLEA-ALT-VENT	36286
POLEA-ALT-VENT	36286	POLEA DEL TENSOR-ALT-VENT	36165
POLEA DEL TENSOR-ALT-VENT	36165	TENSOR-ALT-VENT	38587
TENSOR-ALT-VENT	38587	POLEA-AA	36223
POLEA-AA	36223	TENSOR-AA	38610
TENSOR-AA	38610	TERMOSTATO-190°	34149
TERMOSTATO-190°	34149	TERMOSTATO-180°	34146
TERMOSTATO-180°	34146	TERMOSTATO-180°	34148
TERMOSTATO-180°	34148	BOMBA DE AGUA-	45054HD
BOMBA DE AGUA-	45054HD	MANGUERA SILICÓN-	SIH275363C
MANGUERA SILICÓN-	SIH275363C	2007	
2010		BANDA-TOMA DE FUERZA-AA	K060637
BANDA-TOMA DE FUERZA-AA	K060637	MANGUERA INFERIOR-RAD. A TUBO	22717
MANGUERA INFERIOR-RAD. A TUBO	22717	MANGUERA SILICÓN-MOTOR A TUBO	SIH275363C
BANDA-ALT-VENT	K120842	BANDA-ALT-VENT	K120842
POLEA-ALT-VENT	36286	POLEA-ALT-VENT	36286
POLEA DEL TENSOR-ALT-VENT	36165	POLEA DEL TENSOR-ALT-VENT	36165
TENSOR-ALT-VENT	38587	TENSOR-ALT-VENT	38587
POLEA-AA	36223	POLEA-AA	36223
TENSOR-AA	38610	TENSOR-AA	38610
TERMOSTATO-190°	34149	TERMOSTATO-190°	34149
TERMOSTATO-180°	34146	TERMOSTATO-180°	34146
TERMOSTATO-180°	34148	TERMOSTATO-180°	34148
BOMBA DE AGUA-	45054HD	BOMBA DE AGUA-	45054HD
MANGUERA SILICÓN-	SIH275363C	2006	



MASTER SERVICIO PESADO 2014

VOLVO

VNL

BANDA-TOMA DE FUERZA-AA	K060637	BANDA-VENT	K100510
MANGUERA INFERIOR-RAD. A TUBO	22717	POLEA DEL TENSOR-VENT	36092
BANDA-ALT-VENT	K120842	TENSOR-VENT	38535
POLEA-ALT-VENT	36286	BANDA-TOMA DE FUERZA-ALT-AA-C/PURIF DE AIRE	K060637
POLEA DEL TENSOR-ALT-VENT	36165	BANDA-TOMA DE FUERZA-ALT-AA	K060685
TENSOR-ALT-VENT	38587	POLEA DEL TENSOR-TOMA DE FUERZA-ALT-AA	36095
POLEA-AA	36223	TENSOR-TOMA DE FUERZA-ALT-AA	38532
TENSOR-AA	38610	MANGUERA SILICÓN-MOTOR A TUBO	SIH250363C
TERMOSTATO-190°	34149	TENSOR-ALT-VENT	38587
TERMOSTATO-180°	34146	2002	
TERMOSTATO-180°	34148	BANDA-VENT	K100510
BOMBA DE AGUA-	45054HD	POLEA DEL TENSOR-VENT	36092
MANGUERA SILICÓN-	SIH275363C	TENSOR-VENT	38535
2005		MANGUERA INFERIOR-TUBO A RAD.	22717
BANDA-TOMA DE FUERZA-AA	K060637	BANDA-TOMA DE FUERZA-ALT-AA	K060685
MANGUERA INFERIOR-RAD. A TUBO	22717	POLEA DEL TENSOR-TOMA DE FUERZA-ALT-AA	36095
BANDA-ALT-VENT	K120842	TENSOR-TOMA DE FUERZA-ALT-AA	38532
POLEA-ALT-VENT	36286	MANGUERA SUPERIOR-MOTOR A RAD.	22716
POLEA DEL TENSOR-ALT-VENT	36165	TERMOSTATO-190°	34149
TENSOR-ALT-VENT	38587	TERMOSTATO-180°	34146
POLEA-AA	36223	TERMOSTATO-180°	34148
TENSOR-AA	38610	MANGUERA SILICÓN-	SIH250363C
TERMOSTATO-190°	34149	2001	
TERMOSTATO-180°	34146	BANDA-VENT	K100510
TERMOSTATO-180°	34148	POLEA DEL TENSOR-VENT	36092
BOMBA DE AGUA-	45054HD	TENSOR-VENT	38535
MANGUERA SILICÓN-	SIH275363C	MANGUERA INFERIOR-TUBO A RAD.	22717
2004		BANDA-TOMA DE FUERZA-ALT-AA	K060685
BANDA-TOMA DE FUERZA-AA	K060637	POLEA DEL TENSOR-TOMA DE FUERZA-ALT-AA	36095
MANGUERA INFERIOR-RAD. A TUBO	22717	TENSOR-TOMA DE FUERZA-ALT-AA	38532
BANDA-ALT-VENT	K120842	MANGUERA SUPERIOR-MOTOR A RAD.	22716
POLEA-ALT-VENT	36286	TERMOSTATO-190°	34149
POLEA DEL TENSOR-ALT-VENT	36165	TERMOSTATO-180°	34146
TENSOR-ALT-VENT	38587	TERMOSTATO-180°	34148
POLEA-AA	36223	MANGUERA SILICÓN-	SIH250363C
TENSOR-AA	38610	2000	
TERMOSTATO-190°	34149	BANDA-VENT	K100510
TERMOSTATO-180°	34146	POLEA DEL TENSOR-VENT	36092
TERMOSTATO-180°	34148	TENSOR-VENT	38535
BOMBA DE AGUA-	45054HD	MANGUERA INFERIOR-TUBO A RAD.	22717
MANGUERA SILICÓN-	SIH275363C	BANDA-TOMA DE FUERZA-ALT-AA	K060685
2003		POLEA DEL TENSOR-TOMA DE FUERZA-ALT-AA	36095
BANDA-VENT-C/PURIF DE AIRE	K120842	TENSOR-TOMA DE FUERZA-ALT-AA	38532



MANGUERA SUPERIOR-MOTOR A RAD.	22716	MANGUERA SILICÓN-TUBO A RAD.	SIH250363C
TERMOSTATO-190°	34149	MANGUERA SILICÓN-TUBO A RAD.	SIH300363C
TERMOSTATO-180°	34146	MANGUERA SILICÓN-MOTOR A TUBO	SIH300363C
TERMOSTATO-180°	34148	MANGUERA SUPERIOR-MOTOR A TUBO	21115
MANGUERA SILICÓN-	SIH250363C	BANDA-ALT-VENT-C/ALT 130A DELCO	K080694
CUMMINS ISM DIESEL		TENSOR-ALT-VENT	38505
2003		TERMOSTATO-190°	33579
MANGUERA SILICÓN-TUBO A RAD.	SIH250363C	TERMOSTATO-180°	33576
MANGUERA SUPERIOR-TUBO A RAD.	24436	TERMOSTATO-180°	33578
BANDA-TOMA DE FUERZA-AA	K060415	TERMOSTATO-170°	33577
TENSOR-TOMA DE FUERZA-AA	38607	POLEA DEL TENSOR-	36091
MANGUERA SILICÓN-MOTOR A TUBO	SIH250363C	1998	
MANGUERA SUPERIOR-MOTOR A TUBO	24436	BANDA-VENT	9480
BANDA-ALT-VENT	K100665	BANDA-VENT	9500
POLEA-ALT-VENT	36092	MANGUERA SILICÓN-TUBO A RAD.	SIH250363C
TENSOR-ALT-VENT	38539	MANGUERA SILICÓN-MOTOR A TUBO	SIH300363C
2002		MANGUERA SUPERIOR-MOTOR A TUBO	21115
BANDA-TOMA DE FUERZA-AA	K060532	TERMOSTATO-190°	33579
TENSOR-TOMA DE FUERZA-AA	38607	TERMOSTATO-180°	33576
BANDA-ALT-VENT	K100891	TERMOSTATO-180°	33578
POLEA-ALT-VENT	36092	TERMOSTATO-170°	33577
TENSOR-ALT-VENT	38539	1997	
2001		BANDA-VENT	9480
BANDA-VENT	K080610	BANDA-VENT	9500
MANGUERA INFERIOR-TUBO A RAD.	21891	MANGUERA SILICÓN-TUBO A RAD.	SIH250363C
MANGUERA SILICÓN-TUBO A MOTOR	SIH250363C	MANGUERA SILICÓN-MOTOR A TUBO	SIH300363C
BANDA-TOMA DE FUERZA-ALT	K050345	MANGUERA SUPERIOR-MOTOR A TUBO	21115
MANGUERA INFERIOR-MOTOR A TUBO	21891	TERMOSTATO-190°	33579
MANGUERA SILICÓN-MOTOR A TUBO	SIH250363C	TERMOSTATO-180°	33576
TENSOR-AA	38545	TERMOSTATO-180°	33578
BANDA-	9530	TERMOSTATO-170°	33577
2000		VNL 64T	
BANDA-VENT	K100665	DETROIT DIESEL SERIE 60	
BANDA-ALT-AA	K060415	2000	
1999		BANDA-VENT-AA	PQ17550
BANDA-VENT	K100665	MANGUERA SUPERIOR-TUBO A RAD.	CHARTER 2 1/2"
BANDA-ALT-AA	K060415	MANGUERA SUPERIOR-MOTOR A TUBO	CHARTER 2 1/2"
1998		POLEA-LOCA	38076
BANDA-VENT	K080623	BANDA-ALT-VENT	K080670
BANDA-	9540	MANGUERA INFERIOR-	CHARTER 2 1/2"
CATERPILLAR 3406 DIESEL		TENSOR-	38505
1999		1999	
BANDA-VENT-AA	9510	BANDA-VENT-AA	PQ17550



MASTER SERVICIO PESADO 2014

VOLVO

VNL 64T

MANGUERA SUPERIOR-TUBO A RAD.	CHARTER 2 1/2"	BANDA-VENT	K100582
MANGUERA SUPERIOR-MOTOR A TUBO	CHARTER 2 1/2"	POLEA-VENT	36286
POLEA-LOCA	38076	TENSOR-VENT	38581
BANDA-ALT-VENT	K080670	BANDA-ALT-AA	K080385
MANGUERA INFERIOR-	CHARTER 2 1/2"	TENSOR-ALT-AA	38585
TENSOR-	38505	TAPÓN DE RADIADOR-(20 LBS) SIN PALANCA	31335
VNM		MANGUERA INFERIOR-	22710
VOLVO VE D16 DIESEL		MANGUERA SUPERIOR-	22709
2009		2006	
TENSOR-VENT	38581	BANDA-VENT	K100582
BANDA-BA-VENT	K100578	POLEA-VENT	36286
BANDA-ALT-AA	K080550	TENSOR-VENT	38581
TENSOR-ALT-AA	38585	BANDA-ALT-AA	K080385
TAPÓN DE RADIADOR-(20 LBS) SIN PALANCA	31335	TENSOR-ALT-AA	38585
2008		TAPÓN DE RADIADOR-(20 LBS) SIN PALANCA	31335
TENSOR-VENT	38581	MANGUERA INFERIOR-	22710
BANDA-BA-VENT	K100554	MANGUERA SUPERIOR-	22709
BANDA-ALT-AA	K080550	2003	
TENSOR-ALT-AA	38585	BANDA-VENT	K100437
TAPÓN DE RADIADOR-(20 LBS) SIN PALANCA	31335	BANDA-TOMA DE FUERZA-ALT-AA	K080375
2007		2002	
TENSOR-VENT	38581	BANDA-VENT	K100437
BANDA-BA-VENT	K100554	BANDA-TOMA DE FUERZA-ALT-AA	K080375
BANDA-ALT-AA	K080550	VOLVO VE 12 DIESEL	
TENSOR-ALT-AA	38585	2000	
TAPÓN DE RADIADOR-(20 LBS) SIN PALANCA	31335	BANDA-TOMA DE FUERZA-VENT	K100437
2006		BANDA-TOMA DE FUERZA-ALT-AA	K080375
TENSOR-VENT	38581	1999	
BANDA-BA-VENT	K100554	BANDA-TOMA DE FUERZA-VENT	K080400
BANDA-ALT-AA	K080550	BANDA-TOMA DE FUERZA-ALT-AA	K080408
TENSOR-ALT-AA	38585	VOLVO D16 DIESEL	
TAPÓN DE RADIADOR-(20 LBS) SIN PALANCA	31335	2013	
VOLVO VE D12 DIESEL		TENSOR-VENT	38581
2008		MANGUERA SUPERIOR-MOTOR A TUBO	21891
BANDA-VENT	K100582	BANDA-BA-VENT	K100578
POLEA-VENT	36286	BANDA-ALT-AA	K080550
TENSOR-VENT	38581	TENSOR-ALT-AA	38585
BANDA-ALT-AA	K080385	TAPÓN DE RADIADOR-(20 LBS) SIN PALANCA	31335
TENSOR-ALT-AA	38585	2012	
TAPÓN DE RADIADOR-(20 LBS) SIN PALANCA	31335	TENSOR-VENT	38581
MANGUERA INFERIOR-	22710	MANGUERA SUPERIOR-MOTOR A TUBO	21891
MANGUERA SUPERIOR-	22709	BANDA-BA-VENT	K100578
2007		BANDA-ALT-AA	K080550



MASTER SERVICIO PESADO 2014

VOLVO

VNM

TENSOR-ALT-AA	38585	MANGUERA SUPERIOR-TUBO A MOTOR	22714
TAPÓN DE RADIADOR-(20 LBS) SIN PALANCA	31335	MANGUERA SUPERIOR-RAD. A TUBO	23564
2011		BANDA-ALT-AA	K080630
TENSOR-VENT	38581	TENSOR-ALT	38671
MANGUERA SUPERIOR-MOTOR A TUBO	21891	TAPÓN DE RADIADOR-(20 LBS) SIN PALANCA	31335
BANDA-BA-VENT	K100578	MANGUERA INFERIOR-	23563
BANDA-ALT-AA	K080550	2012	
TENSOR-ALT-AA	38585	BANDA-VENT	K120640
TAPÓN DE RADIADOR-(20 LBS) SIN PALANCA	31335	TENSOR-VENT	38633
2010		MANGUERA SUPERIOR-TUBO A MOTOR	22714
TENSOR-VENT	38581	MANGUERA SUPERIOR-RAD. A TUBO	23564
MANGUERA SUPERIOR-MOTOR A TUBO	21891	BANDA-ALT-AA	K080630
BANDA-BA-VENT	K100578	TENSOR-ALT	38671
BANDA-ALT-AA	K080550	TAPÓN DE RADIADOR-(20 LBS) SIN PALANCA	31335
TENSOR-ALT-AA	38585	MANGUERA INFERIOR-	23563
TAPÓN DE RADIADOR-(20 LBS) SIN PALANCA	31335	2011	
2009		BANDA-VENT	K120640
TENSOR-VENT	38581	TENSOR-VENT	38633
MANGUERA SUPERIOR-MOTOR A TUBO	21891	MANGUERA SUPERIOR-TUBO A MOTOR	22714
BANDA-BA-VENT	K100578	MANGUERA SUPERIOR-RAD. A TUBO	23564
BANDA-ALT-AA	K080550	BANDA-ALT-AA	K080630
TENSOR-ALT-AA	38585	TENSOR-ALT	38671
TAPÓN DE RADIADOR-(20 LBS) SIN PALANCA	31335	TAPÓN DE RADIADOR-(20 LBS) SIN PALANCA	31335
2008		MANGUERA INFERIOR-	23563
TENSOR-VENT	38581	2010	
MANGUERA SUPERIOR-MOTOR A TUBO	21891	BANDA-VENT	K120640
BANDA-BA-VENT	K120610	TENSOR-VENT	38633
BANDA-ALT-AA	K080550	MANGUERA SUPERIOR-TUBO A MOTOR	22714
TENSOR-ALT-AA	38585	MANGUERA SUPERIOR-RAD. A TUBO	23564
TAPÓN DE RADIADOR-(20 LBS) SIN PALANCA	31335	BANDA-ALT-AA	K080630
VOLVO D13 DIESEL		TENSOR-ALT	38671
2014		TAPÓN DE RADIADOR-(20 LBS) SIN PALANCA	31335
BANDA-VENT	K120640	MANGUERA INFERIOR-	23563
TENSOR-VENT	38633	2009	
MANGUERA SUPERIOR-TUBO A MOTOR	22714	BANDA-VENT	K120640
MANGUERA SUPERIOR-RAD. A TUBO	23564	TENSOR-VENT	38633
BANDA-ALT-AA	K080630	MANGUERA SUPERIOR-TUBO A MOTOR	22714
TENSOR-ALT	38671	MANGUERA SUPERIOR-RAD. A TUBO	23564
TAPÓN DE RADIADOR-(20 LBS) SIN PALANCA	31335	BANDA-ALT-AA	K080630
MANGUERA INFERIOR-	23563	TENSOR-ALT	38671
2013		TAPÓN DE RADIADOR-(20 LBS) SIN PALANCA	31335
BANDA-VENT	K120640	MANGUERA INFERIOR-	23563
TENSOR-VENT	38633	2008	



MASTER SERVICIO PESADO 2014

VOLVO

VNM

BANDA-VENT	K120640	2002	
TENSOR-VENT	38633	BANDA-VENT	K100630
MANGUERA SUPERIOR-TUBO A MOTOR	22714	MANGUERA SUPERIOR-TUBO A RAD.	CHARTER 2 1/2"
MANGUERA SUPERIOR-RAD. A TUBO	23564	BANDA-TOMA DE FUERZA-BA	K060425
BANDA-ALT-AA	K080630	TENSOR-TOMA DE FUERZA-BA	38536
TENSOR-ALT	38671	BANDA-TOMA DE FUERZA-AA	8371 GS
TAPÓN DE RADIADOR-(20 LBS) SIN PALANCA	31335	MANGUERA SUPERIOR-MOTOR A TUBO	CHARTER 2 1/2"
MANGUERA INFERIOR-	23563	BANDA-ALT	K050420
DETROIT DIESEL SERIE 60		MANGUERA INFERIOR-	CHARTER 2 1/2"
2000		2001	
BANDA-VENT-AA	PQ17550	BANDA-VENT	K100630
MANGUERA SUPERIOR-TUBO A RAD.	CHARTER 2 1/2"	BANDA-TOMA DE FUERZA-BA	K060425
MANGUERA SUPERIOR-MOTOR A TUBO	CHARTER 2 1/2"	BANDA-TOMA DE FUERZA-AA	8371 GS
BANDA-ALT-VENT	K080670	BANDA-ALT	K050420
MANGUERA INFERIOR-	CHARTER 2 1/2"	MANGUERA INFERIOR-	CHARTER 2 1/2"
1999		2000	
BANDA-VENT-AA	PQ17550	BANDA-VENT	K100630
MANGUERA SUPERIOR-TUBO A RAD.	CHARTER 2 1/2"	MANGUERA SUPERIOR-TUBO A RAD.	CHARTER 2 1/2"
MANGUERA SUPERIOR-MOTOR A TUBO	CHARTER 2 1/2"	BANDA-TOMA DE FUERZA-BA	K060425
BANDA-ALT-VENT	K080670	BANDA-TOMA DE FUERZA-AA	8371 GS
MANGUERA INFERIOR-	CHARTER 2 1/2"	MANGUERA SUPERIOR-MOTOR A TUBO	CHARTER 2 1/2"
1998		BANDA-ALT	K050420
BANDA-VENT-AA	PQ17550	MANGUERA INFERIOR-	CHARTER 2 1/2"
MANGUERA SUPERIOR-TUBO A RAD.	CHARTER 2 1/2"	1999	
MANGUERA SUPERIOR-MOTOR A TUBO	CHARTER 2 1/2"	MANGUERA SUPERIOR-TUBO A RAD.	CHARTER 2 1/2"
BANDA-ALT-VENT	K080670	BANDA-TOMA DE FUERZA-VENT	K080384
MANGUERA INFERIOR-	CHARTER 2 1/2"	BANDA-TOMA DE FUERZA-BA	K060425
CUMMINS SIGNATURE 600 DIESEL		BANDA-TOMA DE FUERZA-AA	8371 GS
2003		MANGUERA SUPERIOR-MOTOR A TUBO	CHARTER 2 1/2"
BANDA-TOMA DE FUERZA-VENT (S/EGR)	K100510	BANDA-ALT	PQ17450
BANDA-TOMA DE FUERZA-ALT-AA (ALT S/EGR)	K060685	MANGUERA INFERIOR-	CHARTER 2 1/2"
BANDA-TOMA DE FUERZA-ALT-AA (ALT C/EGR)	K060637	1998	
MANGUERA INFERIOR-	CHARTER 2 1/2"	MANGUERA SUPERIOR-TUBO A RAD.	CHARTER 2 1/2"
CUMMINS N14 DIESEL		BANDA-TOMA DE FUERZA-VENT	K080384
2003		BANDA-TOMA DE FUERZA-BA	K060425
BANDA-VENT	K100630	BANDA-TOMA DE FUERZA-AA	8371 GS
MANGUERA SUPERIOR-TUBO A RAD.	CHARTER 2 1/2"	MANGUERA SUPERIOR-MOTOR A TUBO	CHARTER 2 1/2"
BANDA-TOMA DE FUERZA-BA	K060425	BANDA-ALT	PQ17450
TENSOR-TOMA DE FUERZA-BA	38536	MANGUERA INFERIOR-	CHARTER 2 1/2"
BANDA-TOMA DE FUERZA-AA	8371 GS	CUMMINS M11 DIESEL	
MANGUERA SUPERIOR-MOTOR A TUBO	CHARTER 2 1/2"	1998	
BANDA-ALT	K050420	BANDA-VENT	K080623
MANGUERA INFERIOR-	CHARTER 2 1/2"	BANDA-AA	PQ17540



MASTER SERVICIO PESADO 2014

VOLVO

VNM

1997			TERMOSTATO-180°	34148
BANDA-VENT	K080623		BOMBA DE AGUA-	45054HD
BANDA-AA	PQ17540		MANGUERA SILICÓN-	SIH275363C
CUMMINS ISX DIESEL				
2013			2010	
BANDA-TOMA DE FUERZA-AA	K060637		BANDA-TOMA DE FUERZA-AA	K060637
MANGUERA INFERIOR-RAD. A TUBO	22717		MANGUERA INFERIOR-RAD. A TUBO	22717
BANDA-ALT-VENT	K120842		BANDA-ALT-VENT	K120842
POLEA-ALT-VENT	36286		POLEA-ALT-VENT	36286
POLEA DEL TENSOR-ALT-VENT	36165		POLEA DEL TENSOR-ALT-VENT	36165
TENSOR-ALT-VENT	38587		TENSOR-ALT-VENT	38587
POLEA-AA	36223		POLEA-AA	36223
TENSOR-AA	38610		TENSOR-AA	38610
TERMOSTATO-190°	34149		TERMOSTATO-190°	34149
TERMOSTATO-180°	34146		TERMOSTATO-180°	34146
TERMOSTATO-180°	34148		TERMOSTATO-180°	34148
BOMBA DE AGUA-	45054HD		BOMBA DE AGUA-	45054HD
MANGUERA SILICÓN-	SIH275363C		MANGUERA SILICÓN-	SIH275363C
2012			2009	
BANDA-TOMA DE FUERZA-AA	K060637		BANDA-TOMA DE FUERZA-AA	K060637
MANGUERA INFERIOR-RAD. A TUBO	22717		MANGUERA INFERIOR-RAD. A TUBO	22717
BANDA-ALT-VENT	K120842		BANDA-ALT-VENT	K120842
POLEA-ALT-VENT	36286		POLEA-ALT-VENT	36286
POLEA DEL TENSOR-ALT-VENT	36165		POLEA DEL TENSOR-ALT-VENT	36165
TENSOR-ALT-VENT	38587		TENSOR-ALT-VENT	38587
POLEA-AA	36223		POLEA-AA	36223
TENSOR-AA	38610		TENSOR-AA	38610
TERMOSTATO-190°	34149		TERMOSTATO-190°	34149
TERMOSTATO-180°	34146		TERMOSTATO-180°	34146
TERMOSTATO-180°	34148		TERMOSTATO-180°	34148
BOMBA DE AGUA-	45054HD		BOMBA DE AGUA-	45054HD
MANGUERA SILICÓN-	SIH275363C		MANGUERA SILICÓN-	SIH275363C
2011			2008	
BANDA-TOMA DE FUERZA-AA	K060637		BANDA-TOMA DE FUERZA-AA	K060637
MANGUERA INFERIOR-RAD. A TUBO	22717		MANGUERA INFERIOR-RAD. A TUBO	22717
BANDA-ALT-VENT	K120842		BANDA-ALT-VENT	K120842
POLEA-ALT-VENT	36286		POLEA-ALT-VENT	36286
POLEA DEL TENSOR-ALT-VENT	36165		POLEA DEL TENSOR-ALT-VENT	36165
TENSOR-ALT-VENT	38587		TENSOR-ALT-VENT	38587
POLEA-AA	36223		POLEA-AA	36223
TENSOR-AA	38610		TENSOR-AA	38610
TERMOSTATO-190°	34149		TERMOSTATO-190°	34149
TERMOSTATO-180°	34146		TERMOSTATO-180°	34146
TERMOSTATO-180°	34148		TERMOSTATO-180°	34148



MASTER SERVICIO PESADO 2014

VOLVO

VNM

BOMBA DE AGUA-	45054HD	MANGUERA INFERIOR-	CHARTER 2 1/2"
MANGUERA SILICÓN-	SIH275363C	2002	
2007		BANDA-TOMA DE FUERZA-VENT (S/EGR)	K100510
BANDA-TOMA DE FUERZA-AA	K060637	BANDA-TOMA DE FUERZA-ALT-AA (ALT S/EGR)	K060685
MANGUERA INFERIOR-RAD. A TUBO	22717	MANGUERA INFERIOR-	CHARTER 2 1/2"
BANDA-ALT-VENT	K120842	CUMMINS ISM DIESEL	
POLEA-ALT-VENT	36286	2003	
POLEA DEL TENSOR-ALT-VENT	36165	MANGUERA SUPERIOR-TUBO A RAD.	CHARTER 2 1/4"
TENSOR-ALT-VENT	38587	MANGUERA SUPERIOR-MOTOR A TUBO	CHARTER 2 1/4"
POLEA-AA	36223	BANDA-ALT-VENT	K100665
TENSOR-AA	38610	BANDA-AA	K060415
TERMOSTATO-190°	34149	MANGUERA INFERIOR-	CHARTER 2 1/2"
TERMOSTATO-180°	34146	CATERPILLAR 3406 DIESEL	
TERMOSTATO-180°	34148	1999	
BOMBA DE AGUA-	45054HD	BANDA-VENT-AA	PQ17510
MANGUERA SILICÓN-	SIH275363C	MANGUERA SUPERIOR-TUBO A RAD.	CHARTER 2 1/2"
2006		MANGUERA SUPERIOR-MOTOR A TUBO	21115
BANDA-TOMA DE FUERZA-AA	K060637	BANDA-ALT-VENT (ALT DELCO 130A)	K080694
MANGUERA INFERIOR-RAD. A TUBO	22717	MANGUERA INFERIOR-	CHARTER 3"
BANDA-ALT-VENT	K120842	1998	
POLEA-ALT-VENT	36286	BANDA-VENT	PQ17480
POLEA DEL TENSOR-ALT-VENT	36165	BANDA-VENT	PQ17500
TENSOR-ALT-VENT	38587	MANGUERA SUPERIOR-TUBO A RAD.	CHARTER 2 1/2"
POLEA-AA	36223	MANGUERA SUPERIOR-MOTOR A TUBO	21115
TENSOR-AA	38610	MANGUERA INFERIOR-	CHARTER 2 1/2"
TERMOSTATO-190°	34149	MANGUERA INFERIOR-	CHARTER 3"
TERMOSTATO-180°	34146	1997	
TERMOSTATO-180°	34148	BANDA-VENT	PQ17480
BOMBA DE AGUA-	45054HD	BANDA-VENT	PQ17500
MANGUERA SILICÓN-	SIH275363C	MANGUERA SUPERIOR-TUBO A RAD.	CHARTER 2 1/2"
2005		MANGUERA SUPERIOR-MOTOR A TUBO	21115
BANDA-TOMA DE FUERZA-AA	K060637	MANGUERA INFERIOR-	CHARTER 2 1/2"
BANDA-ALT-VENT	K120842	MANGUERA INFERIOR-	CHARTER 3"
MANGUERA INFERIOR-	CHARTER 2 3/4"	VT SERIES	
2004		VOLVO VE D16 DIESEL	
BANDA-TOMA DE FUERZA-AA	K060637	2009	
BANDA-ALT-VENT	K120842	TENSOR-VENT	38581
MANGUERA INFERIOR-	CHARTER 2 3/4"	BANDA-BA-VENT	K100554
2003		BANDA-ALT-AA	K080550
BANDA-TOMA DE FUERZA-VENT (S/EGR)	K100510	TENSOR-ALT-AA	38585
BANDA-TOMA DE FUERZA-VENT (C/EGR)	K120842	2008	
BANDA-TOMA DE FUERZA-ALT-AA (ALT S/EGR)	K060685	TENSOR-VENT	38581
BANDA-TOMA DE FUERZA-ALT-AA (ALT C/EGR)	K060637	BANDA-BA-VENT	K100554



BANDA-ALT-AA	K080550	1997	
TENSOR-ALT-AA	38585	BANDA-VENT	K080545
2007		BANDA-VENT	K080565
TENSOR-VENT	38581	MANGUERA INFERIOR-TUBO A RAD.	21891
BANDA-BA-VENT	K100554	MANGUERA SILICÓN-TUBO A RAD.	SIH250363C
BANDA-ALT-AA	K080550	MANGUERA SILICÓN-MOTOR A TUBO	SIH250363C
TENSOR-ALT-AA	38585	MANGUERA SUPERIOR-MOTOR A TUBO	22177
2006		BANDA-ALT	K050345
TENSOR-VENT	38581	TERMOSTATO-190°	33579
BANDA-BA-VENT	K100554	TERMOSTATO-180°	33576
BANDA-ALT-AA	K080550	TERMOSTATO-180°	33578
TENSOR-ALT-AA	38585	TERMOSTATO-170°	33577
VT880		BANDA-	9530
CUMMINS ISX DIESEL		BANDA-	9540
2006		1996	
BANDA-TOMA DE FUERZA-AA	K060637	BANDA-VENT	K080545
MANGUERA INFERIOR-MOTOR A TUBO	24444	BANDA-VENT	K080565
BANDA-ALT-VENT	K120842	MANGUERA INFERIOR-TUBO A RAD.	21891
MANGUERA INFERIOR-	CHARTER 2 1/2"	MANGUERA SILICÓN-TUBO A RAD.	SIH250363C
WCA SERIES		MANGUERA SILICÓN-MOTOR A TUBO	SIH250363C
DETROIT DIESEL 6 CIL, 12.7 L DIESEL		MANGUERA SUPERIOR-MOTOR A TUBO	22177
1997		BANDA-ALT	K050345
TERMOSTATO-190°	33599	TERMOSTATO-190°	33579
1996		TERMOSTATO-180°	33576
TERMOSTATO-190°	33599	TERMOSTATO-180°	33578
DETROIT DIESEL 6 CIL, 11.1 L DIESEL		TERMOSTATO-170°	33577
1998		BANDA-	9530
TERMOSTATO-190°	33599	BANDA-	9540
1997		CUMMINS ISM DIESEL	
TERMOSTATO-190°	33599	1998	
1996		BANDA-VENT	K080545
TERMOSTATO-190°	33599	BANDA-VENT	K080565
CUMMINS N14 DIESEL		BANDA-ALT	K050345
1997		BANDA-	9530
TERMOSTATO-190°	33579	BANDA-	9540
TERMOSTATO-180°	33576	CATERPILLAR 3406 DIESEL	
TERMOSTATO-180°	33578	1997	
TERMOSTATO-170°	33577	TERMOSTATO-190°	33579
1996		TERMOSTATO-180°	33576
TERMOSTATO-190°	33579	TERMOSTATO-180°	33578
TERMOSTATO-180°	33576	TERMOSTATO-170°	33577
TERMOSTATO-180°	33578	1996	
TERMOSTATO-170°	33577	TERMOSTATO-190°	33579
CUMMINS M11 DIESEL			



TERMOSTATO-180° 33576

TERMOSTATO-180° 33578

TERMOSTATO-170° 33577

CATERPILLAR 3176 DIESEL

1997

TERMOSTATO-190° 33969

TERMOSTATO-180° 33968

1996

TERMOSTATO-190° 33969

TERMOSTATO-180° 33968

WG SERIES

VOLVO VE D12 DIESEL

2001

MANGUERA INFERIOR-TUBO A RAD. 22715

BANDA-TOMA DE FUERZA-VENT K080566

TENSOR-TOMA DE FUERZA-VENT 38531

BANDA-TOMA DE FUERZA-ALT-AA K050380

MANGUERA INFERIOR-MOTOR A TUBO 22714

MANGUERA SUPERIOR-MOTOR A RAD. 22713

2000

MANGUERA INFERIOR-TUBO A RAD. 22715

BANDA-TOMA DE FUERZA-VENT K080566

TENSOR-TOMA DE FUERZA-VENT 38531

BANDA-TOMA DE FUERZA-ALT-AA K050380

MANGUERA INFERIOR-MOTOR A TUBO 22714

MANGUERA SUPERIOR-MOTOR A RAD. 22713

1999

BANDA-VENT K080565

MANGUERA INFERIOR-TUBO A RAD. 22715

BANDA-TOMA DE FUERZA-VENT K080566

TENSOR-TOMA DE FUERZA-VENT 38531

BANDA-TOMA DE FUERZA-ALT-AA K050380

MANGUERA INFERIOR-MOTOR A TUBO 22714

MANGUERA SUPERIOR-MOTOR A RAD. 22713

TENSOR-ALT-AA 38531

1998

MANGUERA INFERIOR-TUBO A RAD. 22715

BANDA-TOMA DE FUERZA-VENT K080566

TENSOR-TOMA DE FUERZA-VENT 38531

BANDA-TOMA DE FUERZA-ALT-AA K050380

MANGUERA INFERIOR-MOTOR A TUBO 22714

MANGUERA SUPERIOR-MOTOR A RAD. 22713

DETROIT DIESEL 6 CIL, 11.1 L DIESEL

2000

TERMOSTATO-190° 33599

1999

TERMOSTATO-190° 33599

1998

TERMOSTATO-190° 33599

1997

TERMOSTATO-190° 33599

1996

TERMOSTATO-190° 33599

CUMMINS N14 DIESEL

1997

BANDA-VENT K080435

BANDA-BA K060425

BANDA-ALT 2/9451PB

BANDA-ALT 2/9463PB

BANDA-ALT 9451

BANDA-ALT 9463

TERMOSTATO-190° 33579

TERMOSTATO-180° 33576

TERMOSTATO-180° 33578

TERMOSTATO-170° 33577

BANDA- 9370

1996

BANDA-VENT K080435

MANGUERA SILICÓN-TUBO A RAD. SIH250363C

MANGUERA SILICÓN-MOTOR A TUBO SIH250363C

BANDA-BA K060425

BANDA-ALT 2/9451PB

BANDA-ALT 2/9463PB

BANDA-ALT 9451

BANDA-ALT 9463

TERMOSTATO-190° 33579

TERMOSTATO-180° 33576

TERMOSTATO-180° 33578

TERMOSTATO-170° 33577

BANDA- 9370

BANDA- TR28390

CUMMINS M11 DIESEL

1997

MANGUERA INFERIOR-TUBO A TUBO 21042

MANGUERA INFERIOR-TUBO A RAD. 21042

MANGUERA INFERIOR-TUBO A RAD. 21115



MANGUERA SILICÓN-TUBO A RAD.	SIH250363C	MANGUERA INFERIOR-TUBO A RAD.	21115
BANDA-TOMA DE FUERZA-ALT-C/ALT 130A DELCO	K050345	MANGUERA SILICÓN-TUBO A RAD.	SIH250363C
BANDA-TOMA DE FUERZA-AA	9530	MANGUERA SILICÓN-MOTOR A TUBO	SIH250363C
MANGUERA SILICÓN-MOTOR A TUBO	SIH250363C	MANGUERA SUPERIOR-MOTOR A TUBO	22177
MANGUERA SILICÓN-MOTOR A TUBO	SIH300363C	BANDA-ALT	K050340
TERMOSTATO-190°	33579	BANDA-ALT	K050345
TERMOSTATO-180°	33576	TERMOSTATO-190°	33579
TERMOSTATO-180°	33578	TERMOSTATO-180°	33576
TERMOSTATO-170°	33577	TERMOSTATO-180°	33578
1996		TERMOSTATO-175°	33960
BANDA-VENT	K080545	TERMOSTATO-170°	33577
BANDA-VENT	K080565	BANDA-	9530
MANGUERA INFERIOR-TUBO A RAD.	21115	BANDA-	9540
MANGUERA SILICÓN-TUBO A RAD.	SIH250363C	CUMMINS ISM DIESEL	
MANGUERA SILICÓN-MOTOR A TUBO	SIH250363C	2001	
MANGUERA SUPERIOR-MOTOR A TUBO	22177	BANDA-VENT	K080610
BANDA-ALT	K050345	MANGUERA INFERIOR-TUBO A TUBO	21042
TERMOSTATO-190°	33579	MANGUERA INFERIOR-TUBO A RAD.	21042
TERMOSTATO-180°	33576	MANGUERA SILICÓN-TUBO A RAD.	SIH250363C
TERMOSTATO-180°	33578	BANDA-TOMA DE FUERZA-ALT	K050345
TERMOSTATO-170°	33577	BANDA-TOMA DE FUERZA-AA	9530
BANDA-	9530	MANGUERA SILICÓN-MOTOR A TUBO	SIH250363C
BANDA-	9540	2000	
CUMMINS L10 DIESEL		BANDA-VENT	K080610
1997		MANGUERA INFERIOR-TUBO A TUBO	21042
BANDA-VENT	K080545	MANGUERA INFERIOR-TUBO A RAD.	21042
BANDA-VENT	K080565	MANGUERA SILICÓN-TUBO A RAD.	SIH250363C
MANGUERA INFERIOR-TUBO A RAD.	21115	BANDA-TOMA DE FUERZA-ALT-C/ALT 130A DELCO	K050345
MANGUERA SILICÓN-TUBO A RAD.	SIH250363C	BANDA-TOMA DE FUERZA-AA	9530
MANGUERA SILICÓN-MOTOR A TUBO	SIH250363C	MANGUERA SILICÓN-MOTOR A TUBO	SIH250363C
MANGUERA SUPERIOR-MOTOR A TUBO	22177	MANGUERA SILICÓN-MOTOR A TUBO	SIH300363C
BANDA-ALT	K050340	1999	
BANDA-ALT	K050345	MANGUERA INFERIOR-TUBO A TUBO	21042
TERMOSTATO-190°	33579	MANGUERA INFERIOR-TUBO A RAD.	21042
TERMOSTATO-180°	33576	MANGUERA INFERIOR-TUBO A RAD.	21115
TERMOSTATO-180°	33578	MANGUERA SILICÓN-TUBO A RAD.	SIH250363C
TERMOSTATO-175°	33960	BANDA-TOMA DE FUERZA-ALT-C/ALT 130A DELCO	K050345
TERMOSTATO-170°	33577	BANDA-TOMA DE FUERZA-AA	9530
BANDA-	9530	MANGUERA SILICÓN-MOTOR A TUBO	SIH250363C
BANDA-	9540	MANGUERA SILICÓN-MOTOR A TUBO	SIH300363C
1996		1998	
BANDA-VENT	K080545	MANGUERA INFERIOR-TUBO A TUBO	21042
BANDA-VENT	K080565	MANGUERA INFERIOR-TUBO A RAD.	21042



MANGUERA INFERIOR-TUBO A RAD.	21115	WIA SERIES	
MANGUERA SILICÓN-TUBO A RAD.	SIH250363C	VOLVO VE D12 DIESEL	
BANDA-TOMA DE FUERZA-ALT-C/ALT 130A DELCO	K050345	1997	
BANDA-TOMA DE FUERZA-AA	9530	BANDA-VENT	K080575
MANGUERA SILICÓN-MOTOR A TUBO	SIH250363C	BANDA-ALT-AA	K050380
MANGUERA SILICÓN-MOTOR A TUBO	SIH300363C	MANGUERA SUPERIOR-	21115
CATERPILLAR 3306 DIESEL		1996	
1997		BANDA-VENT	K080575
BANDA-VENT	9610	MANGUERA INFERIOR-MOTOR A RAD.	21891
MANGUERA INFERIOR-TUBO A RAD.	20987	BANDA-ALT-AA	K050380
MANGUERA SUPERIOR-TUBO A RAD.	20987	MANGUERA SUPERIOR-	21115
MANGUERA SILICÓN-MOTOR A TUBO	SIH250363C	DETROIT DIESEL 6 CIL, 12.7 L DIESEL	
BANDA-ALT	2/9463PB	1998	
BANDA-ALT	9463	BANDA-VENT	9550
TERMOSTATO-175°	33549	BANDA-VENT	9580
BANDA-	9570	MANGUERA SILICÓN-TUBO A RAD.	SIH250363C
1996		MANGUERA SILICÓN-MOTOR A TUBO	SIH250363C
BANDA-VENT- OPCIONAL	9610	BANDA-ALT-BA-AA	9490
BANDA-VENT	2/9610PB	BANDA-ALT-AA	2/9490PB
MANGUERA INFERIOR-TUBO A RAD.	20987	BANDA-ALT-AA	9490
MANGUERA SILICÓN-TUBO A RAD.	SIH250363C	TERMOSTATO-190°	33599
MANGUERA SUPERIOR-TUBO A RAD.	20987	1997	
MANGUERA SILICÓN-MOTOR A TUBO	SIH250363C	BANDA-VENT	9550
BANDA-ALT	2/9447PB	BANDA-VENT	9580
BANDA-ALT	2/9451PB	MANGUERA SILICÓN-TUBO A RAD.	SIH250363C
BANDA-ALT	2/9463PB	MANGUERA SILICÓN-MOTOR A TUBO	SIH250363C
BANDA-ALT	9447	BANDA-ALT-BA-AA	9490
BANDA-ALT	9451	BANDA-ALT-AA	2/9490PB
BANDA-ALT	9463	BANDA-ALT-AA	9490
TERMOSTATO-175°	33549	TERMOSTATO-190°	33599
BANDA-	9560	1996	
BANDA-	9570	BANDA-VENT	9550
CATERPILLAR 3176 DIESEL		BANDA-VENT	9580
1997		MANGUERA SILICÓN-TUBO A RAD.	SIH250363C
TERMOSTATO-190°	33579	MANGUERA SILICÓN-MOTOR A TUBO	SIH250363C
TERMOSTATO-180°	33576	BANDA-ALT-BA-AA	9490
TERMOSTATO-180°	33578	BANDA-ALT-AA	2/9490PB
TERMOSTATO-170°	33577	BANDA-ALT-AA	9490
1996		TERMOSTATO-190°	33599
TERMOSTATO-190°	33579	DETROIT DIESEL 6 CIL, 11.1 L DIESEL	
TERMOSTATO-180°	33576	1998	
TERMOSTATO-180°	33578	BANDA-VENT	9550
TERMOSTATO-170°	33577	BANDA-VENT	9580



MASTER SERVICIO PESADO 2014

VOLVO

WIA SERIES

MANGUERA SILICÓN-TUBO A RAD.	SIH250363C	BANDA-VENT	K080400
MANGUERA SILICÓN-MOTOR A TUBO	SIH250363C	BANDA-VENT	K080415
BANDA-ALT-BA-AA	9490	BANDA-VENT	K080427
BANDA-ALT-AA	2/9490PB	MANGUERA SILICÓN-TUBO A RAD.	SIH250363C
BANDA-ALT-AA	9490	MANGUERA SILICÓN-MOTOR A TUBO	SIH250363C
TERMOSTATO-190°	33599	BANDA-BA	K060415
1997		BANDA-BA	K060425
BANDA-VENT	9550	BANDA-BA	K060435
BANDA-VENT	9580	BANDA-ALT	2/9463PB
MANGUERA SILICÓN-TUBO A RAD.	SIH250363C	BANDA-ALT	9451
MANGUERA SILICÓN-MOTOR A TUBO	SIH250363C	BANDA-ALT	9463
BANDA-ALT-BA-AA	9490	TERMOSTATO-190°	33579
BANDA-ALT-AA	2/9490PB	TERMOSTATO-180°	33576
BANDA-ALT-AA	9490	TERMOSTATO-180°	33578
TERMOSTATO-190°	33599	TERMOSTATO-170°	33577
1996		BANDA-	9370
BANDA-VENT	9550	BANDA-	TR28390
BANDA-VENT	9580	BANDA-	TR28400
MANGUERA SILICÓN-TUBO A RAD.	SIH250363C	1996	
MANGUERA SILICÓN-MOTOR A TUBO	SIH250363C	BANDA-VENT	K080400
BANDA-ALT-BA-AA	9490	BANDA-VENT	K080415
BANDA-ALT-AA	2/9490PB	BANDA-VENT	K080427
BANDA-ALT-AA	9490	MANGUERA SILICÓN-TUBO A RAD.	SIH250363C
TERMOSTATO-190°	33599	MANGUERA SILICÓN-MOTOR A TUBO	SIH250363C
CUMMINS N14 DIESEL		BANDA-BA	K060425
1998		BANDA-BA	K060435
BANDA-VENT	K080400	BANDA-ALT	2/9463PB
BANDA-VENT	K080415	BANDA-ALT	9451
BANDA-VENT	K080427	BANDA-ALT	9463
MANGUERA SILICÓN-TUBO A RAD.	SIH250363C	TERMOSTATO-190°	33579
MANGUERA SILICÓN-MOTOR A TUBO	SIH250363C	TERMOSTATO-180°	33576
MANGUERA SUPERIOR-MOTOR A TUBO	21115	TERMOSTATO-180°	33578
BANDA-BA	K060415	TERMOSTATO-170°	33577
BANDA-ALT	2/9463PB	BANDA-	9370
BANDA-ALT	9451	BANDA-	TR28390
BANDA-ALT	9463	BANDA-	TR28400
TERMOSTATO-190°	33579	CUMMINS M11 DIESEL	
TERMOSTATO-180°	33576	1997	
TERMOSTATO-180°	33578	BANDA-VENT	K080545
TERMOSTATO-170°	33577	BANDA-VENT	K080565
BANDA-	9370	BANDA-ALT	K050345
BANDA-	TR28390	TERMOSTATO-190°	33579
1997		TERMOSTATO-180°	33576



MASTER SERVICIO PESADO 2014

VOLVO

WIA SERIES

TERMOSTATO-180°	33578	MANGUERA SILICÓN-TUBO A RAD.	SIH250363C
TERMOSTATO-170°	33577	MANGUERA SILICÓN-MOTOR A TUBO	SIH250363C
BANDA-	9530	BANDA-ALT	K050345
BANDA-	9540	BANDA-	9530
1996		BANDA-	9540
BANDA-VENT	K080545	CATERPILLAR 3406 DIESEL	
BANDA-VENT	K080565	1998	
BANDA-ALT	K050345	BANDA-VENT	TR22553
TERMOSTATO-190°	33579	MANGUERA SILICÓN-TUBO A RAD.	SIH250363C
TERMOSTATO-180°	33576	MANGUERA SILICÓN-TUBO A RAD.	SIH300363C
TERMOSTATO-180°	33578	MANGUERA SILICÓN-MOTOR A TUBO	SIH250363C
TERMOSTATO-170°	33577	MANGUERA SILICÓN-MOTOR A TUBO	SIH300363C
BANDA-	9530	BANDA-ALT-VENT-AA	9530
BANDA-	9540	TERMOSTATO-190°	33579
CUMMINS L10 DIESEL		TERMOSTATO-180°	33576
1997		TERMOSTATO-180°	33578
BANDA-VENT	K080545	TERMOSTATO-170°	33577
BANDA-VENT	K080565	1997	
MANGUERA INFERIOR-TUBO A RAD.	21115	BANDA-VENT	TR22553
MANGUERA SILICÓN-TUBO A RAD.	SIH250363C	MANGUERA SILICÓN-TUBO A RAD.	SIH250363C
MANGUERA SILICÓN-MOTOR A TUBO	SIH250363C	MANGUERA SILICÓN-TUBO A RAD.	SIH300363C
BANDA-ALT	K050345	MANGUERA SILICÓN-MOTOR A TUBO	SIH250363C
TERMOSTATO-190°	33579	MANGUERA SILICÓN-MOTOR A TUBO	SIH300363C
TERMOSTATO-180°	33576	BANDA-ALT-VENT-AA	9530
TERMOSTATO-180°	33578	TERMOSTATO-190°	33579
TERMOSTATO-175°	33960	TERMOSTATO-180°	33576
TERMOSTATO-170°	33577	TERMOSTATO-180°	33578
BANDA-	9530	TERMOSTATO-170°	33577
BANDA-	9540	1996	
CUMMINS ISM DIESEL		BANDA-VENT	TR22553
1999		MANGUERA SILICÓN-TUBO A RAD.	SIH250363C
BANDA-VENT	K080545	MANGUERA SILICÓN-TUBO A RAD.	SIH300363C
BANDA-VENT	K080565	MANGUERA SILICÓN-MOTOR A TUBO	SIH250363C
MANGUERA INFERIOR-TUBO A RAD.	21115	MANGUERA SILICÓN-MOTOR A TUBO	SIH300363C
MANGUERA SILICÓN-TUBO A RAD.	SIH250363C	BANDA-ALT-AA	9525
MANGUERA SILICÓN-MOTOR A TUBO	SIH250363C	TERMOSTATO-190°	33579
BANDA-ALT	K050345	TERMOSTATO-180°	33576
BANDA-	9530	TERMOSTATO-180°	33578
BANDA-	9540	TERMOSTATO-170°	33577
1998		CATERPILLAR 3176 DIESEL	
BANDA-VENT	K080545	1997	
BANDA-VENT	K080565	TERMOSTATO-190°	33579
MANGUERA INFERIOR-TUBO A RAD.	21115	TERMOSTATO-180°	33576



TERMOSTATO-180°	33578	TERMOSTATO-180°	33576
TERMOSTATO-170°	33577	TERMOSTATO-180°	33578
1996		TERMOSTATO-175°	33960
TERMOSTATO-190°	33579	TERMOSTATO-170°	33577
TERMOSTATO-180°	33576	1996	
TERMOSTATO-180°	33578	BANDA-VENT	K080510
TERMOSTATO-170°	33577	BANDA-VENT	K080530
XPEDITOR		BANDA-VENT	K080545
VOLVO VE D7 DIESEL		BANDA-VENT	K080560
2000		BANDA-VENT	K080585
BANDA-VENT	9610	MANGUERA SILICÓN-TUBO A RAD.	SIH250363C
BANDA-ALT-VENT	7417	MANGUERA SILICÓN-MOTOR A TUBO	SIH250363C
BANDA-ALT-VENT	7495	MANGUERA SUPERIOR-MOTOR A TUBO	24436
1999		BANDA-ALT	K050340
BANDA-VENT	9610	TERMOSTATO-190°	33579
BANDA-VENT	9625	TERMOSTATO-180°	33576
BANDA-ALT	7425	TERMOSTATO-180°	33578
BANDA-	9415	TERMOSTATO-175°	33960
CUMMINS M11 DIESEL		TERMOSTATO-170°	33577
1998		BANDA-	9555
TERMOSTATO-190°	33579	CUMMINS ISC DIESEL	
TERMOSTATO-180°	33576	2001	
TERMOSTATO-180°	33578	TERMOSTATO-180°-C/DOBLE TERMOSTATO	33966
TERMOSTATO-170°	33577	CUMMINS ISC CNG	
1997		2002	
TERMOSTATO-190°	33579	TERMOSTATO-180°-C/DOBLE TERMOSTATO	33966
TERMOSTATO-180°	33576	CUMMINS C Series 8.3 L DIESEL	
TERMOSTATO-180°	33578	1996	
TERMOSTATO-170°	33577	BANDA-VENT	K080670
1996		BANDA-ALT	K080670
TERMOSTATO-190°	33579	CATERPILLAR 3306 DIESEL	
TERMOSTATO-180°	33576	1999	
TERMOSTATO-180°	33578	BANDA-ALT-AA	9476
TERMOSTATO-170°	33577	TERMOSTATO-175°	33549
CUMMINS L10 DIESEL		1998	
1998		TERMOSTATO-175°	33549
TERMOSTATO-190°	33579	1997	
TERMOSTATO-180°	33576	TERMOSTATO-175°	33549
TERMOSTATO-180°	33578	1996	
TERMOSTATO-175°	33960	BANDA-VENT- OPCIONAL	9500
TERMOSTATO-170°	33577	BANDA-VENT	2/9500PB
1997		BANDA-VENT	K080560
TERMOSTATO-190°	33579	MANGUERA INFERIOR-TUBO A RAD.	21116
		MANGUERA SILICÓN-TUBO A RAD.	SIH250363C



MASTER SERVICIO PESADO 2014

VOLVO

XPEDITOR

MANGUERA INFERIOR-TUBO A ENFRIADOR	21042
MANGUERA SUPERIOR-MOTOR A TUBO	21115
BANDA-ALT	2/9447PB
BANDA-ALT	9405
BANDA-ALT	9447
TERMOSTATO-175°	33549
BANDA-	9490
MANGUERA DE AGUA-	30T 5/8"
MANGUERA DE PASO-	CHARTER 1 3/4"



UTILITARIOS





MASTER SERVICIO PESADO 2014

CHEVROLET

LUV

CHEVROLET



CHEVROLET

UTILITARIOS

LUV

4 CIL, 2.2 L

2003

MANGUERA INFERIOR-	CH-140242
MANGUERA SUPERIOR-	CH-140231
BANDA-ALT-VENT	7417
BANDA-ÁRBOL DE LEVAS {148 D x 20 MM}	T1502
BANDA-COMPRESOR	9380
BANDA-DH	9378

2002

MANGUERA INFERIOR-	CH-140242
MANGUERA SUPERIOR-	CH-140231
BANDA-ALT-VENT	7417
BANDA-ÁRBOL DE LEVAS {148 D x 20 MM}	T1502
BANDA-COMPRESOR	9380
BANDA-DH	9378

2001

MANGUERA INFERIOR-	CH-140242
MANGUERA SUPERIOR-	CH-140231
BANDA-ALT-VENT	7417
BANDA-ÁRBOL DE LEVAS {148 D x 20 MM}	T1502
BANDA-COMPRESOR	9380
BANDA-DH	9378

2000

BANDA-C/AA, C/DH	8380 GS
BANDA-S/AA, C/DH	6417 GS
BANDA-S/AA, C/DH	8371 GS

S-10

V6, 4.3 L

2002

MANGUERA DE PASO-	19025
MANGUERA INFERIOR-	22039
MANGUERA SUPERIOR-	22196
TAPÓN DE ACEITE-	31103
TAPÓN DE RADIADOR-(16 LBS) SIN PALANCA	31528
TERMOSTATO-195°	33019
BANDA-C/AA	K060950
MANGUERA DE CALEFACCIÓN-CALEFACTOR A BA	19070
MANGUERA DE CALEFACCIÓN-CALEFACTOR A MOTOR	19707
POLEA-MOTOR	38001
TENSOR-MOTOR	38103
EDH - (32") - 16mm Macho "O" Ring x 18mm Macho "O" Ring-PRESIÓN	80276
BANDA-S/AA	K060870
TAPÓN DE GASOLINA-SIN LLAVE	31636
2001	
MANGUERA DE PASO-	19025
MANGUERA INFERIOR-	22039
MANGUERA SUPERIOR-	22196
TAPÓN DE ACEITE-	31103
POLEA DEL TENSOR-	38008
TAPÓN DE RADIADOR-(16 LBS) SIN PALANCA	31528
TERMOSTATO-195°	33019
BANDA-C/AA	K060950
MANGUERA DE CALEFACCIÓN-CALEFACTOR A BA	19070
MANGUERA DE CALEFACCIÓN-CALEFACTOR A MOTOR	19707
POLEA-MOTOR	38001
EDH - (32") - 16mm Macho "O" Ring x 18mm Macho "O" Ring-PRESIÓN	80276
BANDA-S/AA	K060870
TENSOR-S/AA	38103
TAPÓN DE GASOLINA-SIN LLAVE	31636
2000	
POLEA DEL TENSOR-	38008



MASTER SERVICIO PESADO 2014

CHEVROLET

S-10

MANGUERA DE PASO-	19025	MANGUERA DE PASO-	19025
MANGUERA INFERIOR-	22039	MANGUERA INFERIOR-	22039
MANGUERA SUPERIOR-	22196	MANGUERA SUPERIOR-	22196
TAPÓN DE ACEITE-	31103	TAPÓN DE ACEITE-	31103
TAPÓN DE RADIADOR-(16 LBS) SIN PALANCA	31528	TAPÓN DE RADIADOR-(16 LBS) SIN PALANCA	31528
TERMOSTATO-195°	33019	TERMOSTATO-195°	33019
BANDA-C/AA	K060950	BANDA-C/AA	K060950
MANGUERA DE CALEFACCIÓN-CALEFACTOR A BA	19070	POLEA-MOTOR	38001
MANGUERA DE CALEFACCIÓN-CALEFACTOR A MOTOR	19707	EDH - (38 5/8") - (entrada sensor) 16mm Macho "O" Ring x 18mm Macho "O" Ring-PRESIÓN	80053
POLEA-MOTOR	38001	BANDA-S/AA	K060870
EDH - (32") - 16mm Macho "O" Ring x 18mm Macho "O" Ring-PRESIÓN	80276	TENSOR-S/AA	38103
TENSOR-S/AA	38103	TAPÓN DE GASOLINA-SIN LLAVE	31636
BANDA-S/AA	K060870	1997	
TAPÓN DE GASOLINA-SIN LLAVE	31636	MANGUERA DE PASO-	19025
1999		MANGUERA INFERIOR-	22039
TAPÓN DE ACEITE-	31103	MANGUERA SUPERIOR-	22196
POLEA DEL TENSOR-	38008	TAPÓN DE ACEITE-	31103
MANGUERA DE PASO-	19025	POLEA DEL TENSOR-	38008
MANGUERA INFERIOR-	22039	TAPÓN DE RADIADOR-(16 LBS) SIN PALANCA	31528
MANGUERA SUPERIOR-	22196	TERMOSTATO-195°	33019
TAPÓN DE RADIADOR-(16 LBS) SIN PALANCA	31528	BANDA-C/AA	K060950
TERMOSTATO-195°	33019	POLEA-MOTOR	38001
BANDA-C/AA	K060950	EDH - (38 5/8") - (entrada sensor) 16mm Macho "O" Ring x 18mm Macho "O" Ring-PRESIÓN	80053
MANGUERA DE CALEFACCIÓN-CALEFACTOR A BA	19070	BANDA-S/AA	K060870
MANGUERA DE CALEFACCIÓN-CALEFACTOR A MOTOR	19707	TENSOR-S/AA	38103
POLEA-MOTOR	38001	TAPÓN DE GASOLINA-SIN LLAVE	31636
EDH - (38 5/8") - (entrada sensor) 16mm Macho "O" Ring x 18mm Macho "O" Ring-PRESIÓN	80053	1996	
BANDA-S/AA	K060870	MANGUERA DE PASO-	19025
TENSOR-S/AA	38103	MANGUERA INFERIOR-	22039
TAPÓN DE GASOLINA-SIN LLAVE	31636	MANGUERA SUPERIOR-	22196
1998		TAPÓN DE ACEITE-	31103
POLEA DEL TENSOR-	38008	POLEA DEL TENSOR-	38008

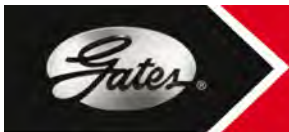

MASTER SERVICIO PESADO 2014

CHEVROLET

S-10

TAPÓN DE RADIADOR-(16 LBS) SIN PALANCA	31528	MANGUERA INFERIOR-	22039
TERMOSTATO-195°	33019	TAPÓN DE ACEITE-	31103
BANDA-C/AA	K060950	TAPÓN DE RADIADOR-(16 LBS) SIN PALANCA	31523
POLEA-MOTOR	38001	TERMOSTATO-195°	33429
EDH - (32") - 16mm Macho "O" Ring x 18mm Macho "O" Ring-PRESIÓN	80276	BANDA-C/AA	K060956
BANDA-S/AA	K060870	TAPÓN DE GASOLINA-CON LLAVE	31778
TENSOR-S/AA	38103	POLEA DEL TENSOR-MOTOR	38001
TAPÓN DE GASOLINA-SIN LLAVE	31636	TENSOR-MOTOR	38108
1995		EDH - (38") - 16mm Macho "O" Ring x 18mm Macho "O" Ring-PRESIÓN	71404
MANGUERA INFERIOR-	22039	BANDA-S/AA	K060938
TAPÓN DE ACEITE-	31103	1992	
TAPÓN DE RADIADOR-(16 LBS) SIN PALANCA	31523	MANGUERA INFERIOR-	22039
TERMOSTATO-195°	33429	TAPÓN DE ACEITE-	31103
BANDA-C/AA	K060956	TAPÓN DE RADIADOR-(16 LBS) SIN PALANCA	31523
POLEA-C/AA	38006	TERMOSTATO-195°	33429
POLEA DEL TENSOR-C/AA	38001	BANDA-C/AA	K060956
TENSOR-C/AA	38108	TAPÓN DE GASOLINA-CON LLAVE	31778
EDH - (38") - 16mm Macho "O" Ring x 18mm Macho "O" Ring-PRESIÓN	71404	POLEA DEL TENSOR-MOTOR	38001
POLEA-S/AA	38024	TENSOR-MOTOR	38108
BANDA-S/AA	K060938	EDH - (38") - 16mm Macho "O" Ring x 18mm Macho "O" Ring-PRESIÓN	71404
TAPÓN DE GASOLINA-SIN LLAVE	31748	BANDA-S/AA	K060938
1994		1991	
MANGUERA INFERIOR-	CH-147162	BANDA-C/AA	K060956
MANGUERA SUPERIOR-	CH-147151	TAPÓN DE GASOLINA-CON LLAVE	31778
BANDA-C/AA	K060956	BANDA-S/AA	K060938
POLEA-C/AA	38006	V6, 3.1 L	
TAPÓN DE GASOLINA-CON LLAVE	31778	1994	
POLEA DEL TENSOR-MOTOR	38001	MANGUERA INFERIOR-	CH-147162
TENSOR-MOTOR	38108	MANGUERA SUPERIOR-	CH-147151
POLEA-S/AA	38024	TAPÓN DE GASOLINA-CON LLAVE	31778
BANDA-S/AA	K060938	1993	
1993		MANGUERA INFERIOR-	CH-147162



MASTER SERVICIO PESADO 2014

CHEVROLET

S-10

MANGUERA SUPERIOR-	CH-147151	BANDA-ÁRBOL DE LEVAS	CADENA
TAPÓN DE GASOLINA-CON LLAVE	31778	BANDA-C/AA	K060744
1992		MANGUERA DE CALEFACCIÓN-CALEFACCIÓN A TUBO	28466
MANGUERA INFERIOR-	CH-147162	MANGUERA DE ENFRIAMIENTO-CALEFACTOR A TUBO-1	28469
MANGUERA SUPERIOR-	CH-147151	MANGUERA DE CALEFACCIÓN-CALEFACTOR A TUBO-2	19747
TAPÓN DE GASOLINA-CON LLAVE	31778	TAPÓN DE GASOLINA-CON LLAVE	31782
1991		TENSOR-MOTOR	38165
MANGUERA INFERIOR-	CH-147162	EDH - (38 5/8") - (entrada sensor) 16mm Macho "O" Ring x 18mm Macho "O" Ring-PRESIÓN	80053
MANGUERA SUPERIOR-	CH-147151	MANGUERA DE ENFRIAMIENTO-RECUPERADOR	35B 3/8"
TAPÓN DE GASOLINA-CON LLAVE	31778	BANDA-S/AA	K060637
4 CIL, 2.2 L		MANGUERA DE AGUA-TUBO A BA	30T 3/4"
2003		MANGUERA DE ENFRIAMIENTO-TUBO A MOTOR	18079
MANGUERA INFERIOR-	22037	2001	
MANGUERA SUPERIOR-	22356	POLEA DEL TENSOR-	38015
TAPÓN DE RADIADOR-(16 LBS) SIN PALANCA	31528	MANGUERA INFERIOR-	22037
TERMOSTATO-195°	33429	MANGUERA SUPERIOR-	22356
BANDA-ÁRBOL DE LEVAS	CADENA	TAPÓN DE ACEITE-	31103
MANGUERA DE CALEFACCIÓN-CALEFACCIÓN A TUBO	28466	TAPÓN DE RADIADOR-(16 LBS) SIN PALANCA	31528
MANGUERA DE CALEFACCIÓN-CALEFACTOR A TUBO-2	19747	TERMOSTATO-195°	33429
TAPÓN DE GASOLINA-CON LLAVE	31782	BANDA-ÁRBOL DE LEVAS	CADENA
POLEA-MOTOR	38015	BANDA-C/AA	K060744
EDH - (38 5/8") - (entrada sensor) 16mm Macho "O" Ring x 18mm Macho "O" Ring-PRESIÓN	80053	MANGUERA DE CALEFACCIÓN-CALEFACTOR A TUBO-2	19747
BANDA-S/AA	K060637	TENSOR-MOTOR	38165
BANDA-S/AA	K060744	EDH - (38 5/8") - (entrada sensor) 16mm Macho "O" Ring x 18mm Macho "O" Ring-PRESIÓN	80053
MANGUERA DE ENFRIAMIENTO-TUBO A MOTOR	18079	BANDA-S/AA	K060637
2002		TAPÓN DE GASOLINA-SIN LLAVE	31636
POLEA DEL TENSOR-	38015	MANGUERA DE ENFRIAMIENTO-TUBO A MOTOR	18079
TAPÓN DE ACEITE-	31103	2000	
MANGUERA INFERIOR-	22037	MANGUERA INFERIOR-	22037
MANGUERA SUPERIOR-	22356	MANGUERA SUPERIOR-	22356
TAPÓN DE RADIADOR-(16 LBS) SIN PALANCA	31528	POLEA DEL TENSOR-	38015
TERMOSTATO-195°	33429	TAPÓN DE ACEITE-	31103

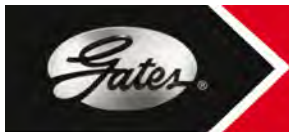

MASTER SERVICIO PESADO 2014

CHEVROLET

S-10

TAPÓN DE RADIADOR-(16 LBS) SIN PALANCA	31528	BANDA-ÁRBOL DE LEVAS	CADENA
TERMOSTATO-195°	33429	BANDA-C/AA	K060744
BANDA-ÁRBOL DE LEVAS	CADENA	TENSOR-MOTOR	38165
BANDA-C/AA	K060744	EDH - (38 5/8") - (entrada sensor) 16mm Macho "O" Ring x 18mm Macho "O" Ring-PRESIÓN	80053
MANGUERA DE CALEFACCIÓN-CALEFACTOR A TUBO-2	19747	BANDA-S/AA	K060637
TENSOR-MOTOR	38165	TAPÓN DE GASOLINA-SIN LLAVE	31636
EDH - (38 5/8") - (entrada sensor) 16mm Macho "O" Ring x 18mm Macho "O" Ring-PRESIÓN	80053	1997	
BANDA-S/AA	K060637	POLEA DEL TENSOR-	38001
TAPÓN DE GASOLINA-SIN LLAVE	31636	MANGUERA INFERIOR-	22037
MANGUERA DE ENFRIAMIENTO-TUBO A MOTOR	18079	MANGUERA SUPERIOR-	21752
1999		TAPÓN DE ACEITE-	31124
MANGUERA INFERIOR-	22037	TAPÓN DE RADIADOR-(16 LBS) SIN PALANCA	31528
MANGUERA SUPERIOR-	22356	TERMOSTATO-195°	33429
TAPÓN DE ACEITE-	31103	BANDA-ÁRBOL DE LEVAS	CADENA
POLEA DEL TENSOR-	38015	BANDA-C/AA	K060755
TAPÓN DE RADIADOR-(16 LBS) SIN PALANCA	31528	TENSOR-MOTOR	38187
TERMOSTATO-195°	33429	EDH - (38 5/8") - (entrada sensor) 16mm Macho "O" Ring x 18mm Macho "O" Ring-PRESIÓN	80053
BANDA-ÁRBOL DE LEVAS	CADENA	BANDA-S/AA	K060653
BANDA-C/AA	K060744	TAPÓN DE GASOLINA-SIN LLAVE	31636
MANGUERA DE CALEFACCIÓN-CALEFACTOR A TUBO-2	19747	1996	
TENSOR-MOTOR	38165	POLEA DEL TENSOR-	38001
EDH - (38 5/8") - (entrada sensor) 16mm Macho "O" Ring x 18mm Macho "O" Ring-PRESIÓN	80053	MANGUERA INFERIOR-	22037
BANDA-S/AA	K060637	MANGUERA SUPERIOR-	21752
TAPÓN DE GASOLINA-SIN LLAVE	31636	TAPÓN DE ACEITE-	31124
MANGUERA DE ENFRIAMIENTO-TUBO A MOTOR	18079	TAPÓN DE RADIADOR-(16 LBS) SIN PALANCA	31528
1998		TERMOSTATO-195°	33429
MANGUERA INFERIOR-	22037	BANDA-ÁRBOL DE LEVAS	CADENA
MANGUERA SUPERIOR-	22356	BANDA-C/AA	K060755
POLEA DEL TENSOR-	38015	TENSOR-MOTOR	38187
TAPÓN DE ACEITE-	31124	EDH - (38 5/8") - (entrada sensor) 16mm Macho "O" Ring x 18mm Macho "O" Ring-PRESIÓN	80053
TAPÓN DE RADIADOR-(16 LBS) SIN PALANCA	31528	BANDA-S/AA	K060653
TERMOSTATO-195°	33429	TAPÓN DE GASOLINA-SIN LLAVE	31636



MASTER SERVICIO PESADO 2014

CHEVROLET

S-10

1995		MANGUERA INFERIOR-	CH-140222
POLEA DEL TENSOR-	38001	MANGUERA SUPERIOR-	CH-140201
TAPÓN DE ACEITE-	31127	TENSOR-ÁRBOL DE LEVAS	TPG-14004
MANGUERA INFERIOR-	22037	BANDA-ÁRBOL DE LEVAS {111 D x 17 MM}	T203
MANGUERA SUPERIOR-	21752	BANDA-C/AA	K050715
TAPÓN DE RADIADOR-(16 LBS) SIN PALANCA	31523	BANDA-S/AA	K050690
TERMOSTATO-195°	33429	2011	
BANDA-ÁRBOL DE LEVAS	CADENA	MANGUERA INFERIOR-	CH-140222
BANDA-C/AA	K060755	MANGUERA SUPERIOR-	CH-140201
TENSOR-MOTOR	38187	TENSOR-ÁRBOL DE LEVAS	TPG-14004
EDH - (38 5/8") - (entrada sensor) 16mm Macho "O" Ring x 18mm Macho "O" Ring-PRESIÓN	80053	BANDA-ÁRBOL DE LEVAS {111 D x 17 MM}	T203
BANDA-S/AA	K060653	BANDA-C/AA	K050715
TAPÓN DE GASOLINA-SIN LLAVE	31748	BANDA-S/AA	K050690
1994		2010	
MANGUERA INFERIOR FLEXIBLE-	12T202	MANGUERA INFERIOR-	CH-140222
MANGUERA SUPERIOR-	21753	MANGUERA SUPERIOR-	CH-140201
BANDA-ÁRBOL DE LEVAS	CADENA	TENSOR-ÁRBOL DE LEVAS	TPG-14004
BANDA-C/AA	K060755	BANDA-ÁRBOL DE LEVAS {111 D x 17 MM}	T203
TAPÓN DE GASOLINA-CON LLAVE	31778	BANDA-C/AA	K050715
POLEA DEL TENSOR-MOTOR	38001	BANDA-S/AA	K050690
TENSOR-MOTOR	38187	2009	
BANDA-S/AA	K060653	MANGUERA INFERIOR-	CH-140222
TORNADO		MANGUERA SUPERIOR-	CH-140201
4 CIL, 1.8 L		TENSOR-ÁRBOL DE LEVAS	TPG-14004
2013		BANDA-ÁRBOL DE LEVAS {111 D x 17 MM}	T203
MANGUERA INFERIOR-	CH-140222	BANDA-C/AA	K050715
MANGUERA SUPERIOR-	CH-140201	BANDA-S/AA	K050690
TENSOR-ÁRBOL DE LEVAS	TPG-14004	2008	
BANDA-ÁRBOL DE LEVAS {111 D x 17 MM}	T203	MANGUERA INFERIOR-	CH-140222
BANDA-C/AA	K050715	MANGUERA SUPERIOR-	CH-140201
BANDA-S/AA	K050690	TENSOR-ÁRBOL DE LEVAS	TPG-14004
2012		BANDA-ÁRBOL DE LEVAS {111 D x 17 MM}	T203



MASTER SERVICIO PESADO 2014

CHEVROLET

TORNADO

BANDA-C/AA	K050715	MANGUERA SUPERIOR-	CH-140201
BANDA-S/AA	K050690	TENSOR-ÁRBOL DE LEVAS	TPG-14004

2007

MANGUERA INFERIOR-	CH-140222	BANDA-C/AA	K050715
MANGUERA SUPERIOR-	CH-140201	BANDA-S/AA	K050690

TENSOR-ÁRBOL DE LEVAS	TPG-14004		
BANDA-ÁRBOL DE LEVAS {111 D x 17 MM}	T203		

BANDA-C/AA	K050715		
BANDA-S/AA	K050690		

2006

MANGUERA INFERIOR-	CH-140222		
MANGUERA SUPERIOR-	CH-140201		

TENSOR-ÁRBOL DE LEVAS	TPG-14004		
BANDA-ÁRBOL DE LEVAS {111 D x 17 MM}	T203		

BANDA-C/AA	K050715		
BANDA-S/AA	K050690		

2005

MANGUERA INFERIOR-	CH-140222		
MANGUERA SUPERIOR-	CH-140201		

TENSOR-ÁRBOL DE LEVAS	TPG-14004		
BANDA-ÁRBOL DE LEVAS {111 D x 17 MM}	T203		

BANDA-C/AA	K050715		
BANDA-S/AA	K050690		

2004

MANGUERA INFERIOR-	CH-140222		
MANGUERA SUPERIOR-	CH-140201		

TENSOR-ÁRBOL DE LEVAS	TPG-14004		
BANDA-ÁRBOL DE LEVAS {111 D x 17 MM}	T203		

BANDA-C/AA	K050715		
BANDA-S/AA	K050690		

2003

MANGUERA INFERIOR-	CH-140222		
--------------------	-----------	--	--

FIAT



UTILITARIOS

DUCATO

4 CIL, 3.0 L DIESEL

2013

TAPÓN DE RADIADOR-(20 LBS) SIN PALANCA	RC216
--	-------

BANDA STRETCH FIT-AA	4PK1102SF
----------------------	-----------

POLEA-AA	T36402
----------	--------

TENSOR-MOTOR	T39137
--------------	--------

BANDA STRETCH FIT-SERPENTIN	K060458
-----------------------------	---------

2012

TAPÓN DE RADIADOR-(20 LBS) SIN PALANCA	RC216
--	-------

BANDA STRETCH FIT-AA	4PK1102SF
----------------------	-----------

POLEA-AA	T36402
----------	--------

TENSOR-MOTOR	T39137
--------------	--------

BANDA STRETCH FIT-SERPENTIN	K060458
-----------------------------	---------

2011

TAPÓN DE RADIADOR-(20 LBS) SIN PALANCA	RC216
--	-------

BANDA STRETCH FIT-AA	4PK1102SF
----------------------	-----------

POLEA-AA	T36402
----------	--------

TENSOR-MOTOR	T39137
--------------	--------

BANDA STRETCH FIT-SERPENTIN	K060458
-----------------------------	---------

2010

TAPÓN DE RADIADOR-(20 LBS) SIN PALANCA	RC216
--	-------

BANDA STRETCH FIT-AA	4PK1102SF
----------------------	-----------

POLEA-AA	T36402
----------	--------

TENSOR-MOTOR	T39137
--------------	--------

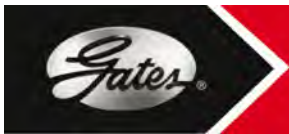

MASTER SERVICIO PESADO 2014

FIAT

DUCATO

BANDA STRETCH FIT-SERPENTIN	K060458	2010	
2009			TAPÓN DE RADIADOR-(20 LBS) SIN PALANCA
TAPÓN DE RADIADOR-(20 LBS) SIN PALANCA	RC216		RC216
BANDA STRETCH FIT-AA	4PK1102SF		BANDA STRETCH FIT-AA
POLEA-AA	T36402		4PK903SF
TENSOR-MOTOR	T39137		BANDA-ÁRBOL DE LEVAS (178 D X 30 MM)
BANDA-SERPENTIN	K060458		5592XS
			TENSOR-MOTOR
			T43163
			BANDA-SERPENTIN
			K070425

2008		2009	
TAPÓN DE RADIADOR-(20 LBS) SIN PALANCA	RC216		TAPÓN DE RADIADOR-(20 LBS) SIN PALANCA
BANDA STRETCH FIT-AA	4PK1102SF		RC216
POLEA-AA	T36402		BANDA STRETCH FIT-AA
TENSOR-MOTOR	T39137		4PK903SF
BANDA-SERPENTIN	K060458		BANDA-ÁRBOL DE LEVAS (178 D X 30 MM)
			5592XS
			TENSOR-MOTOR
			T43163
			BANDA-SERPENTIN
			K070425

4 CIL, 2.3 L DIESEL

2013		2008	
TAPÓN DE RADIADOR-(20 LBS) SIN PALANCA	RC216		TAPÓN DE RADIADOR-(20 LBS) SIN PALANCA
BANDA STRETCH FIT-AA	4PK903SF		RC216
BANDA-ÁRBOL DE LEVAS (178 D X 30 MM)	5592XS		BANDA STRETCH FIT-AA
TENSOR-MOTOR	T43163		4PK903SF
BANDA-SERPENTIN	K070425		BANDA-ÁRBOL DE LEVAS (178 D X 30 MM)
			5592XS
			TENSOR-MOTOR
			T43163
			BANDA-SERPENTIN
			K070425

FORD



UTILITARIOS

COURIER

4 CIL, 1.6 L

2012		2012	
TAPÓN DE RADIADOR-(20 LBS) SIN PALANCA	RC216		MANGUERA INFERIOR-
BANDA STRETCH FIT-AA	4PK903SF		CH-130292
BANDA-ÁRBOL DE LEVAS (178 D X 30 MM)	5592XS		MANGUERA SUPERIOR-
TENSOR-MOTOR	T43163		CH-130281
BANDA-SERPENTIN	K070425		BANDA-C/AA, C/DH
			K060882
			BANDA-C/AA, S/DH
			K060856
			BANDA-S/AA, C/DH
			K060670
			BANDA-S/AA, S/DH
			K060413

2011		2011	
TAPÓN DE RADIADOR-(20 LBS) SIN PALANCA	RC216		MANGUERA INFERIOR-
BANDA STRETCH FIT-AA	4PK903SF		CH-130292
BANDA-ÁRBOL DE LEVAS (178 D X 30 MM)	5592XS		MANGUERA SUPERIOR-
TENSOR-MOTOR	T43163		CH-130281
BANDA-SERPENTIN	K070425		



MASTER SERVICIO PESADO 2014

FORD

COURIER

BANDA-C/AA, C/DH	K060882	BANDA-ÁRBOL DE LEVAS	CADENA
BANDA-C/AA, S/DH	K060856	BANDA-C/AA, C/DH	K060882
BANDA-S/AA, C/DH	K060670	BANDA-C/AA, S/DH	K060856
BANDA-S/AA, S/DH	K060413	BANDA-S/AA, C/DH	K060670
2010		BANDA-S/AA, S/DH	K060413
MANGUERA INFERIOR-	CH-130292	2006	
MANGUERA SUPERIOR-	CH-130281	MANGUERA INFERIOR-	CH-130292
BANDA-C/AA, C/DH	K060882	MANGUERA SUPERIOR-	CH-130281
BANDA-C/AA, S/DH	K060856	TERMOSTATO-180°	33238
BANDA-S/AA, C/DH	K060670	BANDA-ÁRBOL DE LEVAS	CADENA
BANDA-S/AA, S/DH	K060413	BANDA-C/AA, C/DH	K060882
2009		BANDA-C/AA, S/DH	K060856
MANGUERA INFERIOR-	CH-130292	BANDA-S/AA, C/DH	K060670
MANGUERA SUPERIOR-	CH-130281	BANDA-S/AA, S/DH	K060413
BANDA-ÁRBOL DE LEVAS	CADENA	2005	
BANDA-C/AA, C/DH	K060882	MANGUERA INFERIOR-	CH-130292
BANDA-C/AA, S/DH	K060856	MANGUERA SUPERIOR-	CH-130281
BANDA-S/AA, C/DH	K060670	TERMOSTATO-180°	33238
BANDA-S/AA, S/DH	K060413	BANDA-ÁRBOL DE LEVAS	CADENA
2008		BANDA-C/AA, C/DH	K060882
MANGUERA INFERIOR-	CH-130292	BANDA-C/AA, S/DH	K060856
MANGUERA SUPERIOR-	CH-130281	BANDA-S/AA, C/DH	K060670
TERMOSTATO-180°	33238	BANDA-S/AA, S/DH	K060413
BANDA-ÁRBOL DE LEVAS	CADENA	2004	
BANDA-C/AA, C/DH	K060882	MANGUERA INFERIOR-	CH-130292
BANDA-C/AA, S/DH	K060856	MANGUERA SUPERIOR-	CH-130281
BANDA-S/AA, C/DH	K060670	TERMOSTATO-180°	33238
BANDA-S/AA, S/DH	K060413	BANDA-ÁRBOL DE LEVAS	CADENA
2007		BANDA-C/AA, C/DH	K060882
MANGUERA INFERIOR-	CH-130292	BANDA-C/AA, S/DH	K060856
MANGUERA SUPERIOR-	CH-130281	BANDA-S/AA, C/DH	K060670
TERMOSTATO-180°	33238	BANDA-S/AA, S/DH	K060413



MASTER SERVICIO PESADO 2014

FORD

COURIER

2003		TAPÓN DE GASOLINA-SIN LLAVE	31841
MANGUERA INFERIOR-	CH-130292	V8, 5.4 L	
MANGUERA SUPERIOR-	CH-130281	2010	
TERMOSTATO-180°	33238	BANDA-	K060806
BANDA-ÁRBOL DE LEVAS	CADENA	BANDA MOTOR-	K060990
BANDA-C/AA, C/DH	K060882	BANDA MOTOR-	K061005
BANDA-C/AA, S/DH	K060856	POLEA MOTOR-	38001
BANDA-S/AA, C/DH	K060670	POLEA MOTOR-	38006
BANDA-S/AA, S/DH	K060413	TENSOR MOTOR-CON A.A.	38274
F-350 SUPER DUTY		TENSOR-MOTOR	38274
V8, 6.2 L		TENSOR-MOTOR	38329
2013		POLEA-MOTOR	38001
TAPÓN DE ACEITE-	31275	POLEA-MOTOR	38006
BANDA-	K061058	BANDA-MOTOR	K060990
TAPÓN DE RADIADOR-(16 LBS) SIN PALANCA	31406	BANDA-MOTOR	K060806
TAPÓN DE GASOLINA-CON LLAVE	31842	BANDA-MOTOR	K061005
TAPÓN DE GASOLINA-SIN LLAVE	31841	TENSOR MOTOR-SIN A.A.	38329
2012		2009	
TAPÓN DE ACEITE-	31275	TAPÓN DE RADIADOR-(16 LBS) SIN PALANCA	31336
BANDA-	K061058	TERMOSTATO-195°	33469
BANDA MOTOR-	K061058	TAPÓN DE GASOLINA-CON LLAVE	31842
TAPÓN DE RADIADOR-(16 LBS) SIN PALANCA	31406	MANGUERA SUPERIOR-MANG. SUP.	23273
TAPÓN DE RADIADOR-16 LBS.	31406	BANDA-MOTOR	K060997
TAPÓN DE GASOLINA-CON LLAVE	31842	BANDA-MOTOR	K060806
TAPÓN DE GASOLINA-SIN LLAVE	31841	POLEA-MOTOR	36157
2011		POLEA-MOTOR	38001
TAPÓN DE ACEITE-	31275	TENSOR-MOTOR	38274
BANDA-	K061058	TENSOR-MOTOR	38329
BANDA MOTOR-	K061058	TAPÓN DE GASOLINA-SIN LLAVE	31841
TAPÓN DE RADIADOR-(16 LBS) SIN PALANCA	31406	2008	
TAPÓN DE RADIADOR-16 LBS.	31406	TAPÓN DE RADIADOR-(16 LBS) SIN PALANCA	31336
TAPÓN DE GASOLINA-CON LLAVE	31842	TERMOSTATO-195°	33469

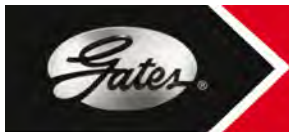

MASTER SERVICIO PESADO 2014

FORD

F-350 SUPER DUTY

TAPÓN DE GASOLINA-CON LLAVE	31842	TENSOR-MOTOR	38330
MANGUERA SUPERIOR-MANG. SUP.	23273	EDH - (29") - 16mm "O" Ring Giratorio x 5/16" "O" Ring Macho-PRESIÓN	352850(80319)
BANDA-MOTOR	K060806	TAPÓN DE GASOLINA-SIN LLAVE C/CONT. DE EMISIÓN	31615
BANDA-MOTOR	K060997	2005	
POLEA-MOTOR	36157	MANGUERA INFERIOR-	22430
POLEA-MOTOR	38001	MANGUERA SUPERIOR-	22429
TENSOR-MOTOR	38274	TAPÓN DE ACEITE-	31109
TENSOR-MOTOR	38329	TAPÓN DE RADIADOR-(16 LBS) SIN PALANCA	31406
TAPÓN DE GASOLINA-SIN LLAVE	31841	TERMOSTATO-195°	33469
2007		BANDA-MOTOR	K060997
MANGUERA SUPERIOR-	23273	POLEA-MOTOR	38001
TAPÓN DE RADIADOR-(16 LBS) SIN PALANCA	31336	POLEA-MOTOR	38022
TERMOSTATO-195°	33469	POLEA-MOTOR	38023
TAPÓN DE GASOLINA-CON LLAVE	31842	TENSOR-MOTOR	38133
BANDA-MOTOR	K060997	TENSOR-MOTOR	38330
BANDA-MOTOR	K060806	EDH - (29") - 16mm "O" Ring Giratorio x 5/16" "O" Ring Macho-PRESIÓN	352850(80319)
POLEA-MOTOR	36157	TAPÓN DE GASOLINA-SIN LLAVE C/CONT. DE EMISIÓN	31615
POLEA-MOTOR	38001	2004	
TENSOR-MOTOR	38274	MANGUERA INFERIOR-	22430
TENSOR-MOTOR	38329	MANGUERA SUPERIOR-	22429
TAPÓN DE GASOLINA-SIN LLAVE	31841	TAPÓN DE ACEITE-	31109
2006		TAPÓN DE RADIADOR-(16 LBS) SIN PALANCA	31406
TAPÓN DE ACEITE-	31109	TERMOSTATO-195°	33469
MANGUERA INFERIOR-	22430	BANDA-MOTOR	K060806
MANGUERA SUPERIOR-	22429	BANDA-MOTOR	K061000
TAPÓN DE RADIADOR-(16 LBS) SIN PALANCA	31406	POLEA-MOTOR	38001
TERMOSTATO-195°	33469	POLEA-MOTOR	38022
BANDA-MOTOR	K060997	TENSOR-MOTOR	38133
POLEA-MOTOR	38001	TENSOR-MOTOR	38274
POLEA-MOTOR	38022	TENSOR-MOTOR	38330
POLEA-MOTOR	38023	EDH - (29") - 16mm "O" Ring Giratorio x 5/16" "O" Ring Macho-PRESIÓN	352850(80319)
TENSOR-MOTOR	38133	TAPÓN DE GASOLINA-SIN LLAVE C/CONT. DE EMISIÓN	31615

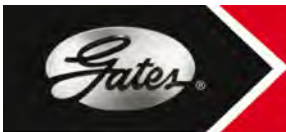

MASTER SERVICIO PESADO 2014

FORD

F-450 SUPER DUTY

F-450 SUPER DUTY

V8, 7.5 L

1998

BANDA MOTOR- **K060685**

1997

MANG. INFERIOR- **21875**

MANG. INFERIOR- **21909**

MANG. SUPERIOR- **21668**

MANGUERA SUPERIOR FLEXIBLE- **1517T200**

TAPÓN DE ACEITE- **31109**

SERPENTIN- **K060685**

POLEA- **38001**

TENSOR PARA BANDA MICRO-V- **38140**

TAPÓN DE RADIADOR-(13 lbs) Sin palanca **31527**

TERMOSTATO-195° **33509**

TAPÓN DE GASOLINA-SIN LLAVE C/CONT. DE EMISION **31615**

V8, 7.3 L

2003

TAPÓN DE ACEITE- **31109**

BANDA MOTOR- **K081223**

POLEA MOTOR- **38028**

TENSOR MOTOR- **38191**

TAPÓN DE RADIADOR-(16 lbs) Sin Palanca **31406**

EDH-(24 3/8") - 16mm "O" Ring Giratorio x 5/16" "O" Ring Macho **80321**

TERMOSTATO-195° **33909**

POLEA MOTOR-LISA **38053**

MANGUERA MOLDEADA-MANG. INF. **22434**

MANGUERA MOLDEADA-MANG. SUP. **22433**

TAPÓN DE GASOLINA-SIN LLAVE **31615**

2002

TAPÓN DE ACEITE- **31109**

BANDA MOTOR- **K081223**

POLEA MOTOR- **38028**

TENSOR MOTOR- **38191**

TAPÓN DE RADIADOR-(16 lbs) Sin Palanca **31406**

EDH-(24 3/8") - 16mm "O" Ring Giratorio x 5/16" "O" Ring Macho **80321**

TERMOSTATO-195° **33909**

POLEA MOTOR-LISA **38053**

MANGUERA MOLDEADA-MANG. INF. **22434**

MANGUERA MOLDEADA-MANG. SUP. **22433**

TAPÓN DE GASOLINA-SIN LLAVE **31615**

2001

TAPÓN DE ACEITE- **31109**

BANDA MOTOR- **K081223**

TAPÓN DE RADIADOR-(16 lbs) Sin Palanca **31406**

EDH-(24 3/8") - 16mm "O" Ring Giratorio x 5/16" "O" Ring Macho **80321**

TERMOSTATO-195° **33909**

MANGUERA MOLDEADA-MANG. INF. **22434**

MANGUERA MOLDEADA-MANG. SUP. **22433**

TAPÓN DE GASOLINA-SIN LLAVE **31615**

2000

MANGUERA MOLDEADA-MANG. INF. **22434**

MANGUERA MOLDEADA-MANG. SUP. **22433**

1999

MANGUERA MOLDEADA-MANG. INF. **22434**

MANGUERA MOLDEADA-MANG. SUP. **22433**

V8, 6.7 L DIESEL

2013

TAPÓN DE ACEITE- **31275**

TAPÓN DE RADIADOR-(16 LBS) SIN PALANCA **31406**

BANDA-1 ALTERNADOR **DK081254**

BANDA-2 ALTERNADORES **DK081403**

TERMOSTATO-201° **33469**

TAPÓN DE GASOLINA-CON LLAVE **31842**

TENSOR-MOTOR **39153**



MASTER SERVICIO PESADO 2014

FORD

F-450 SUPER DUTY

TAPÓN DE GASOLINA-SIN LLAVE	31841	2010	
2012			BANDA MOTOR- K080865
TAPÓN DE GASOLINA-	31841		BANDA MOTOR- K080956
TAPÓN DE ACEITE-	31275		BANDA MOTOR- K060393
TENSOR MOTOR-	39153		POLEA- 36234
TAPÓN DE RADIADOR-(16 LBS) SIN PALANCA	31406		TENSOR MOTOR- 39051
BANDA-1 ALTERNADOR	DK081254		TENSOR MOTOR- 39052
BANDA MOTOR DOBLE RANURADO-1 ALTERNADOR	DK081254		POLEA MOTOR-LISA 36234
TAPÓN DE RADIADOR-16 LBS.	31406		TENSOR-MOTOR 39051
BANDA-2 ALTERNADORES	DK081403		TENSOR-MOTOR 39052
BANDA MOTOR DOBLE RANURADO-2 ALTERNADORES	DK081403		BANDA-MOTOR K080865
TERMOSTATO-201°	33469		BANDA-MOTOR K080956
TERMOSTATO-201°	34240		BANDA-MOTOR K060393
TAPÓN DE GASOLINA-CON LLAVE	31842	2009	
TENSOR-MOTOR	39153		BANDA MOTOR- K080865
TAPÓN DE GASOLINA-SIN LLAVE	31841		BANDA MOTOR- K080956
2011			BANDA MOTOR- K060393
TAPÓN DE GASOLINA-	31841		POLEA- 36234
TAPÓN DE ACEITE-	31275		TENSOR MOTOR- 39051
TENSOR MOTOR-	39153		TENSOR MOTOR- 39052
TAPÓN DE RADIADOR-(16 LBS) SIN PALANCA	31406		POLEA MOTOR-LISA 36234
BANDA-1 ALTERNADOR	DK081254		TENSOR-MOTOR 39051
BANDA MOTOR DOBLE RANURADO-1 ALTERNADOR	DK081254		TENSOR-MOTOR 39052
TAPÓN DE RADIADOR-16 LBS.	31406		BANDA-MOTOR K080865
BANDA-2 ALTERNADORES	DK081403		BANDA-MOTOR K080956
BANDA MOTOR DOBLE RANURADO-2 ALTERNADORES	DK081403		BANDA-MOTOR K060393
TERMOSTATO-201°	33469	2008	
TERMOSTATO-201°	34240		MANGUERA SUPERIOR- 23815
TAPÓN DE GASOLINA-CON LLAVE	31842		TAPÓN DE RADIADOR-(16 LBS) SIN PALANCA 31406
TENSOR-MOTOR	39153		BANDA-C/AA K060393
TAPÓN DE GASOLINA-SIN LLAVE	31841		BANDA-C/ALT DUAL K080956
V8, 6.4 L DIESEL			BANDA-C/ALT SENCILLO K080865



MASTER SERVICIO PESADO 2014

FORD

F-450 SUPER DUTY

MANGUERA INFERIOR-DEPÓSITO-RAD	23818	TAPÓN DE ACEITE-	31109
POLEA-MOTOR	36354	TAPÓN DE ACEITE-	31275
TENSOR-MOTOR	39051	TAPÓN DE RADIADOR-(16 LBS) SIN PALANCA	31336
TENSOR-MOTOR	39052	TERMOSTATO-195°	33469
MANGUERA INFERIOR-RAD-TUBO	23817	TAPÓN DE GASOLINA-CON LLAVE	31842
MANGUERA INFERIOR-TUBO-BA	23816	BANDA-MOTOR	K060990
V8, 5.4 L		BANDA-MOTOR	K060806
2000		BANDA-MOTOR	K061005
BANDA MOTOR-	K080806	POLEA-MOTOR	38001
BANDA MOTOR-	K081000	POLEA-MOTOR	38006
MANGUERA MOLDEADA-MANG. INF.	22430	TENSOR-MOTOR	38274
MANGUERA MOLDEADA-MANG. SUP.	22429	TENSOR-MOTOR	38329
1999		TAPÓN DE GASOLINA-SIN LLAVE	31841
BANDA MOTOR-	K080806	2011	
BANDA MOTOR-	K081000	TAPÓN DE ACEITE-	31109
MANGUERA MOLDEADA-MANG. INF.	22430	TAPÓN DE ACEITE-	31275
MANGUERA MOLDEADA-MANG. SUP.	22429	TAPÓN DE RADIADOR-(16 LBS) SIN PALANCA	31336
V10, 6.8 L		TERMOSTATO-195°	33469
2013		TAPÓN DE GASOLINA-CON LLAVE	31842
TAPÓN DE ACEITE-	31109	BANDA-MOTOR	K060990
TAPÓN DE ACEITE-	31275	BANDA-MOTOR	K060806
TAPÓN DE RADIADOR-(16 LBS) SIN PALANCA	31336	BANDA-MOTOR	K061005
TERMOSTATO-195°	33469	POLEA-MOTOR	38001
TAPÓN DE GASOLINA-CON LLAVE	31842	POLEA-MOTOR	38006
BANDA-MOTOR	K060990	TENSOR-MOTOR	38274
BANDA-MOTOR	K060806	TENSOR-MOTOR	38329
BANDA-MOTOR	K061005	TAPÓN DE GASOLINA-SIN LLAVE	31841
POLEA-MOTOR	38001	2010	
POLEA-MOTOR	38006	BANDA MOTOR-	K060990
TENSOR-MOTOR	38274	BANDA MOTOR-	K061005
TENSOR-MOTOR	38329	POLEA MOTOR-	38001
TAPÓN DE GASOLINA-SIN LLAVE	31841	POLEA MOTOR-	38006
2012			



MASTER SERVICIO PESADO 2014

FORD

F-450 SUPER DUTY

TAPÓN DE ACEITE-	31109	TAPÓN DE ACEITE-CON ROSCA	31109
TAPÓN DE ACEITE-	31275	BANDA-MOTOR	K060990
BANDA-	K060806	BANDA-MOTOR	K060806
TAPÓN DE RADIADOR-(16 LBS) SIN PALANCA	31336	BANDA-MOTOR	K061005
TERMOSTATO-195°	33469	TENSOR-MOTOR	38274
TERMOSTATO-195°	33469	TENSOR-MOTOR	38329
TENSOR MOTOR-CON A.A.	38274	POLEA-MOTOR	38001
TAPÓN DE GASOLINA-CON LLAVE	31842	POLEA-MOTOR	38006
TAPÓN DE ACEITE-CON ROSCA	31109	TENSOR MOTOR-SIN A.A.	38329
BANDA-MOTOR	K060990	TAPÓN DE GASOLINA-SIN LLAVE	31841
BANDA-MOTOR	K060806	TAPÓN DE ACEITE-SIN ROSCA	31275
BANDA-MOTOR	K061005	2008	
TENSOR-MOTOR	38274	TAPÓN DE RADIADOR-(16 LBS) SIN PALANCA	31336
TENSOR-MOTOR	38329	TERMOSTATO-195°	33469
POLEA-MOTOR	38001	TENSOR-C/AA	38274
POLEA-MOTOR	38006	TAPÓN DE GASOLINA-CON LLAVE	31842
TENSOR MOTOR-SIN A.A.	38329	TAPÓN DE ACEITE-CON ROSCA	31109
TAPÓN DE GASOLINA-SIN LLAVE	31841	BANDA-MOTOR	K060990
TAPÓN DE ACEITE-SIN ROSCA	31275	BANDA-MOTOR	K060806
2009		BANDA-MOTOR	K061005
TAPÓN DE ACEITE-	31109	POLEA-MOTOR	38001
TAPÓN DE ACEITE-	31275	POLEA-MOTOR	38006
BANDA-	K060806	TENSOR-S/AA	38329
BANDA MOTOR-	K060990	TAPÓN DE GASOLINA-SIN LLAVE	31841
BANDA MOTOR-	K061005	TAPÓN DE ACEITE-SIN ROSCA	31275
POLEA MOTOR-	38001	2007	
POLEA MOTOR-	38006	BANDA-	K060806
TAPÓN DE RADIADOR-(16 lbs) Sin Palanca	31336	BANDA-	K060997
TERMOSTATO-195°	33469	POLEA MOTOR-	38001
TERMOSTATO-195°	33469	TENSOR MOTOR-	38274
TENSOR MOTOR-CON A.A.	38274	TENSOR MOTOR-	38329
TAPÓN DE GASOLINA-CON LLAVE	31842	TAPÓN DE RADIADOR-(16 lbs) Sin Palanca	31336



MASTER SERVICIO PESADO 2014

FORD

F-450 SUPER DUTY

TERMOSTATO-195°	33469	POLEA MOTOR-	38023
TAPÓN DE GASOLINA-CON LLAVE	31842	TENSOR MOTOR-	38133
POLEA MOTOR-LISA	38001	TAPÓN DE RADIADOR-(16 lbs) Sin Palanca	31406
MANGUERA MOLDEADA-MANG. INF.	23266	EDH-(27 1/4") - 16mm "O" Ring Giratorio x 5/16" "O" Ring Macho	352860(80320)
MANGUERA MOLDEADA-MANG. SUP.	23275	TERMOSTATO-195°	33469
POLEA MOTOR-RANURADA	36157	TAPÓN DE GASOLINA-SIN LLAVE	31615
TAPÓN DE GASOLINA-SIN LLAVE	31841	2003	
2006		TAPÓN DE ACEITE-	31109
TAPÓN DE ACEITE-	31109	BANDA MOTOR-	K080806
BANDA-	K060997	BANDA MOTOR-	K081000
POLEA MOTOR-	38022	POLEA MOTOR-	38022
POLEA MOTOR-	38023	POLEA MOTOR-	38023
TENSOR MOTOR-	38133	TENSOR MOTOR-	38133
TAPÓN DE RADIADOR-(16 lbs) Sin Palanca	31406	TAPÓN DE RADIADOR-(16 lbs) Sin Palanca	31406
EDH-(27 1/4") - 16mm "O" Ring Giratorio x 5/16" "O" Ring Macho	352860(80320)	EDH-(27 1/4") - 16mm "O" Ring Giratorio x 5/16" "O" Ring Macho	352860(80320)
TERMOSTATO-195°	33469	TERMOSTATO-195°	33469
TAPÓN DE GASOLINA-SIN LLAVE	31615	TAPÓN DE GASOLINA-SIN LLAVE	31615
2005		2002	
TAPÓN DE ACEITE-	31109	TAPÓN DE ACEITE-	31109
BANDA-	K060997	BANDA MOTOR-	K080806
POLEA MOTOR-	38022	BANDA MOTOR-	K081000
POLEA MOTOR-	38023	POLEA MOTOR-	38022
TENSOR MOTOR-	38133	POLEA MOTOR-	38023
TAPÓN DE RADIADOR-(16 lbs) Sin Palanca	31406	TENSOR MOTOR-	38133
EDH-(27 1/4") - 16mm "O" Ring Giratorio x 5/16" "O" Ring Macho	352860(80320)	TAPÓN DE RADIADOR-(16 lbs) Sin Palanca	31406
TERMOSTATO-195°	33469	EDH-(27 1/4") - 16mm "O" Ring Giratorio x 5/16" "O" Ring Macho	352860(80320)
TAPÓN DE GASOLINA-SIN LLAVE	31615	TERMOSTATO-195°	33469
2004		TAPÓN DE GASOLINA-SIN LLAVE	31615
TAPÓN DE ACEITE-	31109	2001	
BANDA MOTOR-	K080806	TAPÓN DE ACEITE-	31109
BANDA MOTOR-	K081000	BANDA MOTOR-	K080806
POLEA MOTOR-	38022	BANDA MOTOR-	K081000



MASTER SERVICIO PESADO 2014

FORD

F-450 SUPER DUTY

		F-550 SUPER DUTY	
POLEA MOTOR-	38022		
POLEA MOTOR-	38023	V8, 6.7 L DIESEL	
TENSOR MOTOR-	38133	2013	
TAPÓN DE RADIADOR-(16 lbs) Sin Palanca	31406	TAPÓN DE ACEITE-	31275
EDH-(27 1/4") - 16mm "O" Ring Giratorio x 5/16" "O" Ring Macho	352860(80320)	TAPÓN DE RADIADOR-(16 LBS) SIN PALANCA	31406
TERMOSTATO-195°	33469	BANDA-1 ALTERNADOR	DK081254
TAPÓN DE GASOLINA-SIN LLAVE	31615	BANDA-2 ALTERNADORES	DK081403
2000		TERMOSTATO-201°	33469
TAPÓN DE ACEITE-	31109	TAPÓN DE GASOLINA-CON LLAVE	31842
BANDA MOTOR-	K080806	TENSOR-MOTOR	39153
BANDA MOTOR-	K081000	TAPÓN DE GASOLINA-SIN LLAVE	31841
POLEA MOTOR-	38022	2012	
POLEA MOTOR-	38023	TAPÓN DE ACEITE-	31275
TENSOR MOTOR-	38133	TAPÓN DE RADIADOR-(16 LBS) SIN PALANCA	31406
TAPÓN DE RADIADOR-(16 lbs) Sin Palanca	31406	BANDA-1 ALTERNADOR	DK081254
EDH-(27 1/4") - 16mm "O" Ring Giratorio x 5/16" "O" Ring Macho	352860(80320)	BANDA-2 ALTERNADORES	DK081403
TERMOSTATO-195°	33469	TERMOSTATO-201°	33469
MANGUERA MOLDEADA-MANG. INF.	22432	TAPÓN DE GASOLINA-CON LLAVE	31842
MANGUERA MOLDEADA-MANG. SUP.	22431	TENSOR-MOTOR	39153
TAPÓN DE GASOLINA-SIN LLAVE	31615	TAPÓN DE GASOLINA-SIN LLAVE	31841
1999		2011	
TAPÓN DE ACEITE-	31109	TAPÓN DE ACEITE-	31275
BANDA MOTOR-	K080806	TAPÓN DE RADIADOR-(16 LBS) SIN PALANCA	31406
BANDA MOTOR-	K081000	BANDA-1 ALTERNADOR	DK081254
POLEA MOTOR-	38022	BANDA-2 ALTERNADORES	DK081403
POLEA MOTOR-	38023	TERMOSTATO-201°	33469
TENSOR MOTOR-	38133	TAPÓN DE GASOLINA-CON LLAVE	31842
TAPÓN DE RADIADOR-(16 lbs) Sin Palanca	31406	TENSOR-MOTOR	39153
EDH-(27 1/4") - 16mm "O" Ring Giratorio x 5/16" "O" Ring Macho	352860(80320)	TAPÓN DE GASOLINA-SIN LLAVE	31841
TERMOSTATO-195°	33469	V8, 6.4 L DIESEL	
MANGUERA MOLDEADA-MANG. SUP.	22431	2010	
TAPÓN DE GASOLINA-SIN LLAVE	31615	POLEA-	36234
		TENSOR-MOTOR	39051



MASTER SERVICIO PESADO 2014

FORD

F-550 SUPER DUTY

TENSOR-MOTOR	39052	TAPÓN DE GASOLINA-SIN LLAVE	31841
BANDA-MOTOR	K080865	2009	
BANDA-MOTOR	K080956	TAPÓN DE ACEITE-	31109
BANDA-MOTOR	K060393	TAPÓN DE ACEITE-	31275
2009		TAPÓN DE RADIADOR-(16 LBS) SIN PALANCA	31336
BANDA-	K080865	TERMOSTATO-195°	33469
POLEA-	36234	TAPÓN DE GASOLINA-CON LLAVE	31842
TENSOR-MOTOR	39051	BANDA-MOTOR	K060990
TENSOR-MOTOR	39052	BANDA-MOTOR	K060806
BANDA-MOTOR	K080956	BANDA-MOTOR	K061005
BANDA-MOTOR	K060393	POLEA-MOTOR	38001
2008		POLEA-MOTOR	38006
POLEA-	36234	TENSOR-MOTOR	38274
TENSOR-MOTOR	39051	TENSOR-MOTOR	38329
TENSOR-MOTOR	39052	TAPÓN DE GASOLINA-SIN LLAVE	31841
BANDA-MOTOR	K080865	2008	
BANDA-MOTOR	K080956	TAPÓN DE ACEITE-	31109
BANDA-MOTOR	K060393	TAPÓN DE ACEITE-	31275
V10, 6.8 L		TAPÓN DE RADIADOR-(16 LBS) SIN PALANCA	31336
2010		TERMOSTATO-195°	33469
TAPÓN DE ACEITE-	31109	TAPÓN DE GASOLINA-CON LLAVE	31842
TAPÓN DE ACEITE-	31275	BANDA-MOTOR	K060990
TAPÓN DE RADIADOR-(16 LBS) SIN PALANCA	31336	BANDA-MOTOR	K060806
TERMOSTATO-195°	33469	BANDA-MOTOR	K061005
TAPÓN DE GASOLINA-CON LLAVE	31842	POLEA-MOTOR	38001
BANDA-MOTOR	K060990	POLEA-MOTOR	38006
BANDA-MOTOR	K060806	TENSOR-MOTOR	38274
BANDA-MOTOR	K061005	TENSOR-MOTOR	38329
POLEA-MOTOR	38001	TAPÓN DE GASOLINA-SIN LLAVE	31841
POLEA-MOTOR	38006		
TENSOR-MOTOR	38274		
TENSOR-MOTOR	38329		

RANGER

V6, 4.2 L

2004

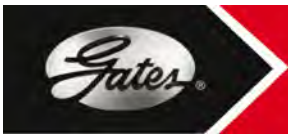

MASTER SERVICIO PESADO 2014

FORD

RANGER

TAPÓN DE RADIADOR-(16 LBS) SIN PALANCA	31406	TENSOR-MOTOR	38137
TAPÓN DE GASOLINA-CON LLAVE	31842	POLEA-MOTOR	38001
BANDA-SERPENTIN	K060866	BANDA-S/AA	K060810
TAPÓN DE GASOLINA-SIN LLAVE	31841	TAPÓN DE GASOLINA-SIN LLAVE	31830
V6, 4.0 L		2000	
2005		POLEA DEL TENSOR-	38008
POLEA-MOTOR	38001	MANGUERA INFERIOR-	22350
TENSOR-MOTOR	38137	MANGUERA SUPERIOR-	22349
2004		TAPÓN DE ACEITE-	31109
POLEA-MOTOR	38001	TAPÓN DE RADIADOR-(16 LBS) SIN PALANCA	31336
POLEA-MOTOR	38008	TERMOSTATO-195°	33779
2003		BANDA-C/AA	K060882
TAPÓN DE GASOLINA-CON LLAVE	31828	TAPÓN DE GASOLINA-CON LLAVE	31828
POLEA-MOTOR	38001	POLEA-MOTOR	38001
POLEA-MOTOR	38008	TENSOR-MOTOR	38102
TENSOR-MOTOR	38137	EDH - (27") - 16mm "O" Ring Giratorio x 16mm "O" Ring Largo Giratorio-PRESIÓN	80322
TAPÓN DE GASOLINA-SIN LLAVE	31830	BANDA-S/AA	K060810
2002		TAPÓN DE GASOLINA-SIN LLAVE	31830
TAPÓN DE GASOLINA-CON LLAVE	31828	1999	
POLEA-MOTOR	38001	MANGUERA INFERIOR-	22350
POLEA-MOTOR	38008	MANGUERA SUPERIOR-	22349
TENSOR-MOTOR	38137	TAPÓN DE ACEITE-	31109
TAPÓN DE GASOLINA-SIN LLAVE	31830	POLEA DEL TENSOR-	38008
2001		TAPÓN DE RADIADOR-(16 LBS) SIN PALANCA	31336
TAPÓN DE ACEITE-	31275	TERMOSTATO-195°	33779
POLEA DEL TENSOR-	38008	BANDA-C/AA	K060882
MANGUERA INFERIOR-	22350	TAPÓN DE GASOLINA-CON LLAVE	31828
MANGUERA SUPERIOR-	22646	TENSOR-MOTOR	38102
TAPÓN DE RADIADOR-(16 LBS) SIN PALANCA	31336	POLEA-MOTOR	38001
TERMOSTATO-195°	33079	EDH - (27") - 16mm "O" Ring Giratorio x 16mm "O" Ring Largo Giratorio-PRESIÓN	80322
BANDA-C/AA	K060882	BANDA-S/AA	K060810
TAPÓN DE GASOLINA-CON LLAVE	31828	TAPÓN DE GASOLINA-SIN LLAVE	31830



MASTER SERVICIO PESADO 2014

FORD

RANGER

1998		TERMOSTATO-195°	33509
POLEA-MOTOR	38001	BANDA-C/AA	K060882
POLEA-MOTOR	38008	TAPÓN DE GASOLINA-CON LLAVE	31828
TENSOR-MOTOR	38102	POLEA-MOTOR	38001
1997		TENSOR-MOTOR	38114
POLEA-MOTOR	38001	MANGUERA DE ENFRIAMIENTO-RECUPERADOR	35B 3/8"
POLEA-MOTOR	38008	BANDA-S/AA	K060858
TENSOR-MOTOR	38102	TAPÓN DE GASOLINA-SIN LLAVE	31830
1996		2001	
POLEA-MOTOR	38001	POLEA DEL TENSOR-	38006
POLEA-MOTOR	38008	MANGUERA INFERIOR-	22351
TENSOR-MOTOR	38102	MANGUERA SUPERIOR-	22144
1995		TAPÓN DE ACEITE-	31275
POLEA-MOTOR	38001	TAPÓN DE RADIADOR-(16 LBS) SIN PALANCA	31336
POLEA-MOTOR	38008	TERMOSTATO-195°	33509
TENSOR-MOTOR	38102	BANDA-C/AA	K060882
V6, 3.0 L		MANGUERA DE CALEFACCIÓN-CALEFACTOR A BA	22469
2005		MANGUERA DE CALEFACCIÓN-CALEFACTOR A MOTOR	22468
POLEA-MOTOR	38001	TAPÓN DE GASOLINA-CON LLAVE	31828
2004		POLEA-MOTOR	38001
POLEA-MOTOR	38001	TENSOR-MOTOR	38114
2003		BANDA-S/AA	K060858
TAPÓN DE GASOLINA-CON LLAVE	31828	TAPÓN DE GASOLINA-SIN LLAVE	31830
POLEA-MOTOR	38001	2000	
POLEA-MOTOR	38006	POLEA DEL TENSOR-	38006
TAPÓN DE GASOLINA-SIN LLAVE	31830	TAPÓN DE ACEITE-	31109
2002		MANGUERA INFERIOR-	22351
POLEA DEL TENSOR-	38006	MANGUERA SUPERIOR-	22144
MANGUERA INFERIOR-	22351	TAPÓN DE RADIADOR-(16 LBS) SIN PALANCA	31336
MANGUERA SUPERIOR-	22144	TERMOSTATO-195°	33509
TAPÓN DE ACEITE-	31275	BANDA-C/AA	K060882
TAPÓN DE RADIADOR-(16 LBS) SIN PALANCA	31336	MANGUERA DE CALEFACCIÓN-CALEFACTOR A MOTOR	22468



MASTER SERVICIO PESADO 2014

FORD

RANGER

TAPÓN DE GASOLINA-CON LLAVE	31828	POLEA-MOTOR	38006
POLEA-MOTOR	38001	TENSOR-MOTOR	38114
TENSOR-MOTOR	38114	1996	
EDH - (27") - 16mm "O" Ring Giratorio x 16mm "O" Ring Largo Giratorio-PRESIÓN	80322	MANGUERA INFERIOR-	22254
BANDA-S/AA	K060858	MANGUERA SUPERIOR-	22144
TAPÓN DE GASOLINA-SIN LLAVE	31830	TAPÓN DE ACEITE-	31109
1999		TAPÓN DE RADIADOR-(16 LBS) SIN PALANCA	31336
TAPÓN DE ACEITE-	31109	TERMOSTATO-195°	33509
POLEA DEL TENSOR-	38006	BANDA-C/AA	K060882
MANGUERA INFERIOR-	22351	TAPÓN DE GASOLINA-CON LLAVE C/CONT. DE EMISIÓN	31734
MANGUERA SUPERIOR-	22144	POLEA-MOTOR	38006
TAPÓN DE RADIADOR-(16 LBS) SIN PALANCA	31336	TENSOR-MOTOR	38114
TERMOSTATO-195°	33509	EDH - (28 3/4") - (entrada sensor) 5/16" Macho flare inv. x 16mm "O" Ring Giratorio-PRESIÓN	71878
BANDA-C/AA	K060882	BANDA-S/AA	K060858
TAPÓN DE GASOLINA-CON LLAVE	31828	1995	
TENSOR-MOTOR	38114	TAPÓN DE GASOLINA-CON LLAVE C/CONT. DE EMISIÓN	31734
POLEA-MOTOR	38001	POLEA-MOTOR	38006
EDH - (27") - 16mm "O" Ring Giratorio x 16mm "O" Ring Largo Giratorio-PRESIÓN	80322	TENSOR-MOTOR	38114
BANDA-S/AA	K060858	4 CIL, 2.5 L	
TAPÓN DE GASOLINA-SIN LLAVE	31830	2003	
1998		TAPÓN DE GASOLINA-CON LLAVE	31828
MANGUERA INFERIOR-	22351	TAPÓN DE GASOLINA-SIN LLAVE	31830
MANGUERA SUPERIOR-	22144	2002	
BANDA-C/AA	K060882	TAPÓN DE GASOLINA-CON LLAVE	31828
BANDA-C/AA, C/DH	K060820	TAPÓN DE GASOLINA-SIN LLAVE	31830
POLEA-MOTOR	38006	2001	
TENSOR-MOTOR	38114	POLEA DEL TENSOR-	38006
EDH - (27") - 16mm "O" Ring Giratorio x 16mm "O" Ring Largo Giratorio-PRESIÓN	80322	MANGUERA INFERIOR-	22364
BANDA-S/AA	K060858	MANGUERA SUPERIOR-	22380
BANDA-S/AA, C/DH	K060696	TAPÓN DE ACEITE-	31109
BANDA-S/AA, S/DH	K060415	TAPÓN DE RADIADOR-(16 LBS) SIN PALANCA	31336
1997		TERMOSTATO-195°	33299



MASTER SERVICIO PESADO 2014

FORD

RANGER

TENSOR-ÁRBOL DE LEVAS	T41005	TERMOSTATO-195°	33299
BANDA-ÁRBOL DE LEVAS {131 D x 22.3 MM}	T276	TENSOR-ÁRBOL DE LEVAS	T41005
BANDA-C/AA	K060820	BANDA-ÁRBOL DE LEVAS {131 D x 22.3 MM}	T276
MANGUERA DE CALEFACCIÓN-CALEFACTOR A BA	18916	BANDA-C/AA	K060820
TAPÓN DE GASOLINA-CON LLAVE	31828	TAPÓN DE GASOLINA-CON LLAVE	31828
TENSOR-MOTOR	38155	TENSOR-MOTOR	38155
POLEA-MOTOR	38001	POLEA-MOTOR	38001
BANDA-S/AA	K060696	EDH - (27") - 16mm "O" Ring Giratorio x 16mm "O" Ring Largo Giratorio-PRESIÓN	80322
TAPÓN DE GASOLINA-SIN LLAVE	31830	BANDA-S/AA	K060696
2000		TAPÓN DE GASOLINA-SIN LLAVE	31830
MANGUERA INFERIOR-	22364	1998	
MANGUERA SUPERIOR-	22380	TENSOR-ÁRBOL DE LEVAS	T41005
TAPÓN DE ACEITE-	31109	TENSOR-MOTOR	38155
POLEA DEL TENSOR-	38006	POLEA-MOTOR	38001
TAPÓN DE RADIADOR-(16 LBS) SIN PALANCA	31336	POLEA-MOTOR	38006
TERMOSTATO-195°	33299	EDH - (27") - 16mm "O" Ring Giratorio x 16mm "O" Ring Largo Giratorio-PRESIÓN	80322
TENSOR-ÁRBOL DE LEVAS	T41005	1996	
BANDA-ÁRBOL DE LEVAS {131 D x 22.3 MM}	T276	MANGUERA INFERIOR-	22364
BANDA-C/AA	K060820	MANGUERA SUPERIOR-	22380
MANGUERA DE CALEFACCIÓN-CALEFACTOR A BA	18916	BANDA-ÁRBOL DE LEVAS {131 D x 22.3 MM}	T276
TAPÓN DE GASOLINA-CON LLAVE	31828	4 CIL, 2.3 L	
TENSOR-MOTOR	38155	2012	
POLEA-MOTOR	38001	TAPÓN DE ACEITE-	31275
EDH - (27") - 16mm "O" Ring Giratorio x 16mm "O" Ring Largo Giratorio-PRESIÓN	80322	MANGUERA INFERIOR-	22654
BANDA-S/AA	K060696	MANGUERA SUPERIOR-	21947
TAPÓN DE GASOLINA-SIN LLAVE	31830	TAPÓN DE RADIADOR-(16 LBS) SIN PALANCA	31406
1999		TERMOSTATO-180°	33469
POLEA DEL TENSOR-	38006	BANDA-C/AA	K060828
TAPÓN DE ACEITE-	31109	TAPÓN DE GASOLINA-CON LLAVE	31842
MANGUERA INFERIOR-	22364	TENSOR-MOTOR	38155
MANGUERA SUPERIOR-	22380	EDH - (25 3/4") - 16mm "O" Ring giratoriox 11mm Macho Captive "O" Ring-PRESIÓN	357480
TAPÓN DE RADIADOR-(16 LBS) SIN PALANCA	31336	BANDA-S/AA	K060730

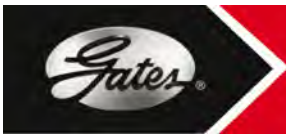

MASTER SERVICIO PESADO 2014

FORD

RANGER

TAPÓN DE GASOLINA-SIN LLAVE	31841	BANDA-MOTOR	K060828
2011			
MANGUERA INFERIOR-	22654	TENSOR-MOTOR	38155
MANGUERA SUPERIOR-	21947	EDH - (25 3/4") - 16mm "O" Ring giratoriox 11mm Macho Captive "O" Ring-PRESIÓN	357480
TAPÓN DE ACEITE-	31275	BANDA-S/AA	K060730
TAPÓN DE RADIADOR-(16 LBS) SIN PALANCA	31406	TAPÓN DE GASOLINA-SIN LLAVE	31841
TERMOSTATO-180°	33469	2008	
BANDA-C/AA	K060828	MANGUERA INFERIOR-	22654
TAPÓN DE GASOLINA-CON LLAVE	31842	MANGUERA SUPERIOR-	21947
TENSOR-MOTOR	38155	TAPÓN DE ACEITE-	31275
EDH - (25 3/4") - 16mm "O" Ring giratoriox 11mm Macho Captive "O" Ring-PRESIÓN	357480	TAPÓN DE RADIADOR-(16 LBS) SIN PALANCA	31406
BANDA-S/AA	K060730	TERMOSTATO-180°	33469
TAPÓN DE GASOLINA-SIN LLAVE	31841	TAPÓN DE GASOLINA-CON LLAVE	31842
2010			
MANGUERA INFERIOR-	22654	TENSOR-MOTOR	38155
MANGUERA SUPERIOR-	21947	BANDA-MOTOR	K060828
TAPÓN DE ACEITE-	31275	EDH - (25 3/4") - 16mm "O" Ring giratoriox 11mm Macho Captive "O" Ring-PRESIÓN	357480
TAPÓN DE RADIADOR-(16 LBS) SIN PALANCA	31406	BANDA-S/AA	K060730
TERMOSTATO-180°	33469	TAPÓN DE GASOLINA-SIN LLAVE	31841
TAPÓN DE GASOLINA-CON LLAVE	31842	2007	
BANDA-MOTOR	K060828	MANGUERA INFERIOR-	22654
TENSOR-MOTOR	38155	MANGUERA SUPERIOR-	21947
EDH - (25 3/4") - 16mm "O" Ring giratoriox 11mm Macho Captive "O" Ring-PRESIÓN	357480	TAPÓN DE RADIADOR-(16 LBS) SIN PALANCA	31406
BANDA-S/AA	K060730	BANDA-C/AA	K060827
TAPÓN DE GASOLINA-SIN LLAVE	31841	TENSOR-MOTOR	38155
2009			
MANGUERA INFERIOR-	22654	EDH - (25 3/4") - 16mm "O" Ring giratoriox 11mm Macho Captive "O" Ring-PRESIÓN	357480
MANGUERA SUPERIOR-	21947	BANDA-S/AA	K060730
TAPÓN DE ACEITE-	31275	TAPÓN DE GASOLINA-SIN LLAVE	31841
TAPÓN DE RADIADOR-(16 LBS) SIN PALANCA	31406	2006	
TERMOSTATO-180°	33469	MANGUERA INFERIOR-	22654
TAPÓN DE GASOLINA-CON LLAVE	31842	MANGUERA SUPERIOR-	21947
2008			
TAPÓN DE GASOLINA-CON LLAVE	31842	TAPÓN DE RADIADOR-(16 LBS) SIN PALANCA	31406
2007			
TAPÓN DE GASOLINA-CON LLAVE	31842	BANDA-C/AA	K060827
2006			
TAPÓN DE GASOLINA-CON LLAVE	31842	TENSOR-MOTOR	38155



MASTER SERVICIO PESADO 2014

FORD

RANGER

EDH - (25 3/4") - 16mm "O" Ring giratoriox 11mm Macho Captive "O" Ring-PRESIÓN	357480	POLEA-C/AA	38001
BANDA-S/AA	K060730	TAPÓN DE GASOLINA-CON LLAVE	31828
TAPÓN DE GASOLINA-SIN LLAVE	31841	TENSOR-MOTOR	38155
2005		EDH - (25 3/4") - 11mm Macho "O" Ring Fijo x 16mm "O" Ring Giratorio-PRESIÓN	80346
MANGUERA INFERIOR-	22654	EDH - (25 3/4") - 16mm "O" Ring giratoriox 11mm Macho Captive "O" Ring-PRESIÓN	357480
TAPÓN DE RADIADOR-(16 LBS) SIN PALANCA	31406	BANDA-S/AA	K060730
BANDA-C/AA	K060827	TAPÓN DE GASOLINA-SIN LLAVE	31830
TENSOR-MOTOR	38155	2002	
EDH - (25 3/4") - 11mm Macho "O" Ring Fijo x 16mm "O" Ring Giratorio-PRESIÓN	80346	POLEA DEL TENSOR-	38006
EDH - (25 3/4") - 16mm "O" Ring giratoriox 11mm Macho Captive "O" Ring-PRESIÓN	357480	MANGUERA INFERIOR-	22654
BANDA-S/AA	K060730	MANGUERA SUPERIOR-	22653
TAPÓN DE GASOLINA-SIN LLAVE	31841	TAPÓN DE ACEITE-	31109
2004		TAPÓN DE RADIADOR-(16 LBS) SIN PALANCA	31406
POLEA DEL TENSOR-	38006	BANDA-ÁRBOL DE LEVAS {131 D x 22.3 MM}	T276
MANGUERA INFERIOR-	22654	BANDA-C/AA	K060827
MANGUERA SUPERIOR-	22653	POLEA-C/AA	38001
TAPÓN DE RADIADOR-(16 LBS) SIN PALANCA	31406	MANGUERA DE CALEFACCIÓN-CALEFACTOR A TUBO-1	19140
BANDA-C/AA	K060827	TAPÓN DE GASOLINA-CON LLAVE	31828
POLEA-C/AA	38001	TENSOR-MOTOR	38155
TAPÓN DE GASOLINA-CON LLAVE	31842	EDH - (25 3/4") - 11mm Macho "O" Ring Fijo x 16mm "O" Ring Giratorio-PRESIÓN	80346
TENSOR-MOTOR	38155	EDH - (25 3/4") - 16mm "O" Ring giratoriox 11mm Macho Captive "O" Ring-PRESIÓN	357480
EDH - (25 3/4") - 11mm Macho "O" Ring Fijo x 16mm "O" Ring Giratorio-PRESIÓN	80346	BANDA-S/AA	K060730
EDH - (25 3/4") - 16mm "O" Ring giratoriox 11mm Macho Captive "O" Ring-PRESIÓN	357480	TAPÓN DE GASOLINA-SIN LLAVE	31830
BANDA-S/AA	K060730	2001	
TAPÓN DE GASOLINA-SIN LLAVE	31841	POLEA DEL TENSOR-	38006
2003		TAPÓN DE ACEITE-	31275
MANGUERA INFERIOR-	22654	MANGUERA DE PASO-	19227
MANGUERA SUPERIOR-	22653	MANGUERA INFERIOR-	22654
TAPÓN DE ACEITE-	31109	MANGUERA SUPERIOR-	22653
POLEA DEL TENSOR-	38006	TAPÓN DE RADIADOR-(16 LBS) SIN PALANCA	31336
TAPÓN DE RADIADOR-(16 LBS) SIN PALANCA	31406	TENSOR-ÁRBOL DE LEVAS	T41005
BANDA-C/AA	K060827	BANDA-ÁRBOL DE LEVAS {131 D x 22.3 MM}	T276



MASTER SERVICIO PESADO 2014

FORD

RANGER

BANDA-C/AA	K060827	MANGUERA SUPERIOR-	22155
MANGUERA DE CALEFACCIÓN-CALEFACTOR A TUBO-1	19140	TENSOR-ÁRBOL DE LEVAS	T41005
TAPÓN DE GASOLINA-CON LLAVE	31828	BANDA-ÁRBOL DE LEVAS {131 D x 22.3 MM}	T276
TENSOR-MOTOR	38155	POLEA-C/AA	38009
EDH - (25 3/4") - 16mm "O" Ring giratoriox 11mm Macho Captive "O" Ring-PRESIÓN	357480	BANDA-C/AA, C/DH	K060820
BANDA-S/AA	K060730	TAPÓN DE GASOLINA-CON LLAVE C/CONT. DE EMISIÓN	31734
TAPÓN DE GASOLINA-SIN LLAVE	31830	TENSOR-MOTOR	38155
2000		EDH - (28 3/4") - (entrada sensor) 5/16" Macho flare inv. x 16mm "O" Ring Giratorio-PRESIÓN	71878
TAPÓN DE GASOLINA-CON LLAVE	31828	BANDA-S/AA, C/DH	K060696
TAPÓN DE GASOLINA-SIN LLAVE	31830	BANDA-S/AA, S/DH	K060415
1999		1995	
TAPÓN DE GASOLINA-CON LLAVE	31828	TENSOR-ÁRBOL DE LEVAS	T41005
TAPÓN DE GASOLINA-SIN LLAVE	31830	TAPÓN DE GASOLINA-CON LLAVE C/CONT. DE EMISIÓN	31734
1997		TENSOR-MOTOR	38155
MANGUERA INFERIOR-	22156	POLEA-MOTOR	38006
MANGUERA SUPERIOR-	22155	POLEA-MOTOR	38009
POLEA DEL TENSOR-	38006	EDH - (28 3/4") - (entrada sensor) 5/16" Macho flare inv. x 16mm "O" Ring Giratorio-PRESIÓN	71878
TAPÓN DE ACEITE-	31109	TRANSIT	
TAPÓN DE RADIADOR-(16 LBS) SIN PALANCA	31336	4 CIL, 2.2 L TDI	
TERMOSTATO-195°	33299	2013	
TENSOR-ÁRBOL DE LEVAS	T41005	MANGUERA INFERIOR-	CH-130122
BANDA-ÁRBOL DE LEVAS {131 D x 22.3 MM}	T276	TAPÓN DE RADIADOR-	RC240
POLEA-C/AA	38009	TERMOSTATO-190°	TH26988G1
BANDA-C/AA, C/DH	K060820	POLEA-AA	T36124
TENSOR-MOTOR	38155	BANDA-C/AA	K060660
EDH - (28 3/4") - (entrada sensor) 5/16" Macho flare inv. x 16mm "O" Ring Giratorio-PRESIÓN	71878	BANDA-DH	4PK922SF
BANDA-S/AA, C/DH	K060696	TENSOR-MOTOR	T39107
BANDA-S/AA, S/DH	K060415	BANDA STRETCH FIT-S/AA	6PK873SF
TAPÓN DE GASOLINA-SIN LLAVE C/CONT. DE EMISIÓN	31615	2012	
1996		MANGUERA INFERIOR-	CH-130122
POLEA DEL TENSOR-	38006	TAPÓN DE RADIADOR-	RC240
MANGUERA INFERIOR-	22156	TERMOSTATO-190°	TH26988G1



MASTER SERVICIO PESADO 2014

FORD

TRANSIT

POLEA-AA	T36124	TENSOR-MOTOR	T39107
BANDA-C/AA	K060660	BANDA STRETCH FIT-S/AA	6PK873SF
BANDA-DH	4PK922SF	2008	
TENSOR-MOTOR	T39107	MANGUERA INFERIOR-	CH-130122
BANDA STRETCH FIT-S/AA	6PK873SF	TAPÓN DE RADIADOR-	RC240
2011		HERRAMIENTA INST. STRECH FIT-	33469
MANGUERA INFERIOR-	CH-130122	TERMOSTATO-190°	TH26988G1
TAPÓN DE RADIADOR-	RC240	POLEA-AA	T36124
TERMOSTATO-190°	TH26988G1	TENSOR-MOTOR	T39107
POLEA-AA	T36124	BANDA-MOTOR	4PK922SF
BANDA-C/AA	K060660	BANDA-MOTOR	K060660
BANDA-DH	4PK922SF	BANDA STRETCH FIT-S/AA	6PK873SF
TENSOR-MOTOR	T39107	BANDA-SERPENTIN	K060660
BANDA STRETCH FIT-S/AA	6PK873SF		

2010

HERRAMIENTA INST. STRECH FIT-	33469
MANGUERA INFERIOR-	CH-130122
TAPÓN DE RADIADOR-	RC240
TERMOSTATO-190°	TH26988G1
POLEA-AA	T36124
BANDA-C/AA	K060660
BANDA-MOTOR	4PK922SF
TENSOR-MOTOR	T39107
BANDA STRETCH FIT-S/AA	6PK873SF

2009

HERRAMIENTA INST. STRECH FIT-	33469
MANGUERA INFERIOR-	CH-130122
TAPÓN DE RADIADOR-	RC240
TERMOSTATO-190°	TH26988G1
POLEA-AA	T36124
BANDA-C/AA	K060660
BANDA-MOTOR	4PK922SF

HYUNDAI



UTILITARIOS

H100

4 CIL, 2.5 L DIESEL

2014

MANGUERA INFERIOR-	CH-119412
MANGUERA SUPERIOR-	CH-119411
BANDA-AA	K040370
BANDA-ALT	K040420
KIT-ÁRBOL DE LEVAS	TCK1096M
TENSOR-ÁRBOL DE LEVAS	T42129
TENSOR-ÁRBOL DE LEVAS	T42130
BANDA-ÁRBOL DE LEVAS (163D X 25.4MM)	T1096
BANDA-ÁRBOL DE LEVAS (99D X 19MM)	T724
BANDA-DH	K040415
2013	
MANGUERA INFERIOR-	CH-119412
MANGUERA SUPERIOR-	CH-119411
BANDA-AA	K040370



MASTER SERVICIO PESADO 2014

HYUNDAI

H100

BANDA-ALT	K040420	BANDA-AA	K040370
KIT-ÁRBOL DE LEVAS	TCK1096M	BANDA-ALT	K040420
TENSOR-ÁRBOL DE LEVAS	T42129	KIT-ÁRBOL DE LEVAS	TCK1096M
TENSOR-ÁRBOL DE LEVAS	T42130	POLEA-ÁRBOL DE LEVAS	T42129
BANDA-ÁRBOL DE LEVAS (163D X 25.4MM)	T1096	TENSOR-ÁRBOL DE LEVAS	T42130
BANDA-ÁRBOL DE LEVAS (99D X 19MM)	T724	BANDA-ÁRBOL DE LEVAS (163D X 25.4MM)	T1096
BANDA-DH	K040415	BANDA-ÁRBOL DE LEVAS (99D X 19MM)	T724
2012		BANDA-DH	K040415
MANGUERA INFERIOR-	CH-119412	2009	
MANGUERA SUPERIOR-	CH-119411	MANGUERA INFERIOR-	CH-119412
BANDA-AA	K040370	MANGUERA SUPERIOR-	CH-119411
BANDA-ALT	K040420	BANDA-AA	K040370
KIT-ÁRBOL DE LEVAS	TCK1096M	BANDA-ALT	K040420
TENSOR-ÁRBOL DE LEVAS	T42129	KIT-ÁRBOL DE LEVAS	TCK1096M
TENSOR-ÁRBOL DE LEVAS	T42130	POLEA-ÁRBOL DE LEVAS	T42129
BANDA-ÁRBOL DE LEVAS (163D X 25.4MM)	T1096	TENSOR-ÁRBOL DE LEVAS	T42130
BANDA-ÁRBOL DE LEVAS (99D X 19MM)	T724	BANDA-ÁRBOL DE LEVAS (163D X 25.4MM)	T1096
BANDA-DH	K040415	BANDA-ÁRBOL DE LEVAS (99D X 19MM)	T724
2011		BANDA-DH	K040415
MANGUERA INFERIOR-	CH-119412	2008	
MANGUERA SUPERIOR-	CH-119411	BANDA-AA	K040370
BANDA-AA	K040370	BANDA-ALT	K040420
BANDA-ALT	K040420	KIT-ÁRBOL DE LEVAS	TCK1096M
KIT-ÁRBOL DE LEVAS	TCK1096M	TENSOR-ÁRBOL DE LEVAS	T42130
TENSOR-ÁRBOL DE LEVAS	T42129	BANDA-ÁRBOL DE LEVAS {163 D x 25.4 MM}	T1096
TENSOR-ÁRBOL DE LEVAS	T42130	BANDA-DH	K040415
BANDA-ÁRBOL DE LEVAS (163D X 25.4MM)	T1096	2007	
BANDA-ÁRBOL DE LEVAS (99D X 19MM)	T724	BANDA-AA	K040370
BANDA-DH	K040415	BANDA-ALT	K040420
2010		KIT-ÁRBOL DE LEVAS	TCK1096M
MANGUERA INFERIOR-	CH-119412	TENSOR-ÁRBOL DE LEVAS	T42130
MANGUERA SUPERIOR-	CH-119411	BANDA-ÁRBOL DE LEVAS {163 D x 25.4 MM}	T1096



MASTER SERVICIO PESADO 2014

HYUNDAI

H100

BANDA-DH	K040415	KIT 3 COMPONENTES-ÁRBOL DE LEVAS	TCK124M
2006		KIT 4 COMPONENTES-ÁRBOL DE LEVAS	TCK124AM
BANDA-AA	K040370	TENSOR-ÁRBOL DE LEVAS	T41044
BANDA-ALT	K040420	TENSOR-ÁRBOL DE LEVAS	T41053
KIT-ÁRBOL DE LEVAS	TCK1096M	BANDA-ÁRBOL DE LEVAS {123 D x 19 MM}	T124
TENSOR-ÁRBOL DE LEVAS	T42130	BANDA-DH	6470MC
BANDA-ÁRBOL DE LEVAS {163 D x 25.4 MM}	T1096	H100 VAN/WAGON	
BANDA-DH	K040415	4 CIL, 2.5 L DIESEL	
4 CIL, 2.4 L		2013	
2005		BANDA-AA	K040370
BANDA-AA	6469MC	BANDA-ALT	K040420
BANDA-ALT	K040385	TENSOR-ÁRBOL DE LEVAS	T42129
BANDA-ÁRBOL DE LEVAS	T159	BANDA-ÁRBOL DE LEVAS (163D X 25.4MM)	T1096
KIT 3 COMPONENTES-ÁRBOL DE LEVAS	TCK124M	BANDA-ÁRBOL DE LEVAS (99D X 19MM)	T724
KIT 4 COMPONENTES-ÁRBOL DE LEVAS	TCK124AM	BANDA-DH	K040415
TENSOR-ÁRBOL DE LEVAS	T41044	2012	
TENSOR-ÁRBOL DE LEVAS	T41053	BANDA-AA	K040370
BANDA-ÁRBOL DE LEVAS {123 D x 19 MM}	T124	BANDA-ALT	K040420
BANDA-DH	6470MC	TENSOR-ÁRBOL DE LEVAS	T42129
2004		BANDA-ÁRBOL DE LEVAS (163D X 25.4MM)	T1096
BANDA-AA	6469MC	BANDA-ÁRBOL DE LEVAS (99D X 19MM)	T724
BANDA-ALT	K040385	BANDA-DH	K040415
BANDA-ÁRBOL DE LEVAS	T159	2011	
KIT 3 COMPONENTES-ÁRBOL DE LEVAS	TCK124M	BANDA-AA	K040370
KIT 4 COMPONENTES-ÁRBOL DE LEVAS	TCK124AM	BANDA-ALT	K040420
TENSOR-ÁRBOL DE LEVAS	T41044	TENSOR-ÁRBOL DE LEVAS	T42129
TENSOR-ÁRBOL DE LEVAS	T41053	BANDA-ÁRBOL DE LEVAS (163D X 25.4MM)	T1096
BANDA-ÁRBOL DE LEVAS {123 D x 19 MM}	T124	BANDA-ÁRBOL DE LEVAS (99D X 19MM)	T724
BANDA-DH	6470MC	BANDA-DH	K040415
2003		2010	
BANDA-AA	6469MC	BANDA-AA	K040370
BANDA-ÁRBOL DE LEVAS	T159	BANDA-ALT	K040420



POLEA-ÁRBOL DE LEVAS	T42129
TENSOR-ÁRBOL DE LEVAS	T42129
BANDA-ÁRBOL DE LEVAS (163D X 25.4MM)	T1096
BANDA-ÁRBOL DE LEVAS (99D X 19MM)	T724
BANDA-DH	K040415

2009

BANDA-AA	K040370
BANDA-ALT	K040420
POLEA-ÁRBOL DE LEVAS	T42129
TENSOR-ÁRBOL DE LEVAS	T42129
BANDA-ÁRBOL DE LEVAS (163D X 25.4MM)	T1096
BANDA-ÁRBOL DE LEVAS (99D X 19MM)	T724
BANDA-DH	K040415

VAN 1000

4 CIL, 2.4 L

2012

BANDA-ALT	K040390
BANDA-DH	K040390

2011

BANDA-ALT	K040390
BANDA-DH	K040390

2010

BANDA-ALT	K040390
BANDA-DH	K040390

2009

BANDA-ALT	K040390
BANDA-DH	K040390

2008

BANDA-ALT	K040390
BANDA-DH	K040390

2007

BANDA-ALT	K040390
-----------	---------

MERCEDES BENZ



UTILITARIOS

SPRINTER

5 CIL, 2.7 L CDI

2006

TENSOR- MOTOR	T38415
TENSOR- MOTOR	T38415
TERMOSTATO-189°	TH35087G1
TERMOSTATO-189°	TH35087G1
BANDA-MOTOR	K060895
BANDA-MOTOR	K060895
POLEA-MOTOR	38099
POLEA-MOTOR	38099

2005

TENSOR- MOTOR	T38415
TENSOR- MOTOR	T38415
TERMOSTATO-189°	TH35087G1
TERMOSTATO-189°	TH35087G1
TERMOSTATO-190°	TH-35087G1
TERMOSTATO-190°	TH-35087G1

BANDA-MOTOR	K060895
BANDA-MOTOR	K060895
POLEA-MOTOR	38099
POLEA-MOTOR	38099

2004

TENSOR- MOTOR	T38415
TENSOR- MOTOR	T38415
TERMOSTATO-189°	TH35087G1
TERMOSTATO-189°	TH35087G1
TERMOSTATO-190°	TH-35087G1
TERMOSTATO-190°	TH-35087G1



MASTER SERVICIO PESADO 2014

MERCEDES BENZ

SPRINTER

BANDA-MOTOR	K060895	TENSOR- MOTOR	T38415
BANDA-MOTOR	K060895	TENSOR- MOTOR	T38415
POLEA-MOTOR	38099	BANDA-MOTOR	K060888
POLEA-MOTOR	38099	BANDA-MOTOR	K060888
2003		BANDA-MOTOR	K060900
TENSOR- MOTOR	T38415	BANDA-MOTOR	K060900
TENSOR- MOTOR	T38415	BANDA-MOTOR	6469MC
TERMOSTATO-189°	TH35087G1	BANDA-MOTOR	6469MC
TERMOSTATO-189°	TH35087G1	POLEA-MOTOR	38099
TERMOSTATO-190°	TH-35087G1	POLEA-MOTOR	38099
TERMOSTATO-190°	TH-35087G1	2011	
BANDA-MOTOR	K060895	TERMOSTATO-	TH35087G1
BANDA-MOTOR	K060895	TERMOSTATO-	TH35087G1
POLEA-MOTOR	38099	TENSOR- MOTOR	T38415
POLEA-MOTOR	38099	TENSOR- MOTOR	T38415
4 CIL, 2.2 L CDI		BANDA-MOTOR	K060888
2013		BANDA-MOTOR	K060888
TERMOSTATO-	TH35087G1	BANDA-MOTOR	K060900
TERMOSTATO-	TH35087G1	BANDA-MOTOR	K060900
TENSOR- MOTOR	T38415	BANDA-MOTOR	6469MC
TENSOR- MOTOR	T38415	BANDA-MOTOR	6469MC
BANDA-MOTOR	K060888	POLEA-MOTOR	38099
BANDA-MOTOR	K060888	POLEA-MOTOR	38099
BANDA-MOTOR	K060900	2010	
BANDA-MOTOR	K060900	TERMOSTATO-	TH35087G1
BANDA-MOTOR	6469MC	TERMOSTATO-	TH35087G1
BANDA-MOTOR	6469MC	TENSOR- MOTOR	T38415
POLEA-MOTOR	38099	TENSOR- MOTOR	T38415
POLEA-MOTOR	38099	TERMOSTATO-189°	TH35087G1
2012		TERMOSTATO-189°	TH35087G1
TERMOSTATO-	TH35087G1	BANDA-MOTOR	K060888
TERMOSTATO-	TH35087G1	BANDA-MOTOR	K060888



MASTER SERVICIO PESADO 2014

MERCEDES BENZ

SPRINTER

BANDA-MOTOR	K060900	BANDA-MOTOR	6469MC
BANDA-MOTOR	K060900	BANDA-MOTOR	6469MC
BANDA-MOTOR	6469MC	POLEA-MOTOR	38099
BANDA-MOTOR	6469MC	POLEA-MOTOR	38099
POLEA-MOTOR	38099	2007	
POLEA-MOTOR	38099	TERMOSTATO-	TH35087G1
2009		TERMOSTATO-	TH35087G1
TERMOSTATO-	TH35087G1	TENSOR- MOTOR	T38415
TERMOSTATO-	TH35087G1	TENSOR- MOTOR	T38415
TENSOR- MOTOR	T38415	TERMOSTATO-189°	TH35087G1
TENSOR- MOTOR	T38415	TERMOSTATO-189°	TH35087G1
TERMOSTATO-189°	TH35087G1	BANDA-MOTOR	6469MC
TERMOSTATO-189°	TH35087G1	BANDA-MOTOR	6469MC
BANDA-MOTOR	K060888	BANDA-MOTOR	K060888
BANDA-MOTOR	K060888	BANDA-MOTOR	K060888
BANDA-MOTOR	K060900	POLEA-MOTOR	38099
BANDA-MOTOR	K060900	POLEA-MOTOR	38099
BANDA-MOTOR	6469MC	2006	
BANDA-MOTOR	6469MC	TERMOSTATO-	TH35087G1
POLEA-MOTOR	38099	TERMOSTATO-	TH35087G1
POLEA-MOTOR	38099	TENSOR- MOTOR	T38415
2008		TENSOR- MOTOR	T38415
TERMOSTATO-	TH35087G1	TERMOSTATO-189°	TH35087G1
TERMOSTATO-	TH35087G1	TERMOSTATO-189°	TH35087G1
TENSOR- MOTOR	T38415	BANDA-MOTOR	6469MC
TENSOR- MOTOR	T38415	BANDA-MOTOR	6469MC
TERMOSTATO-189°	TH35087G1	BANDA-MOTOR	K060888
TERMOSTATO-189°	TH35087G1	BANDA-MOTOR	K060888
BANDA-MOTOR	K060888	POLEA-MOTOR	38099
BANDA-MOTOR	K060888	POLEA-MOTOR	38099
BANDA-MOTOR	K060900	2005	
BANDA-MOTOR	K060900	TERMOSTATO-	TH35087G1



MASTER SERVICIO PESADO 2014

MERCEDES BENZ

SPRINTER

TERMOSTATO-	TH35087G1	TENSOR- MOTOR	T38415
BANDA-MOTOR	6469MC	BANDA-MOTOR	K060888
BANDA-MOTOR	6469MC	BANDA-MOTOR	K060888
2004		BANDA-MOTOR	K060900
TERMOSTATO-	TH35087G1	BANDA-MOTOR	K060900
TERMOSTATO-	TH35087G1	BANDA-MOTOR	6469MC
BANDA-MOTOR	6469MC	BANDA-MOTOR	6469MC
BANDA-MOTOR	6469MC	POLEA-MOTOR	38099
2003		POLEA-MOTOR	38099
TERMOSTATO-	TH35087G1	2011	
TERMOSTATO-	TH35087G1	TERMOSTATO-	TH35087G1
BANDA-MOTOR	6469MC	TERMOSTATO-	TH35087G1
BANDA-MOTOR	6469MC	TENSOR- MOTOR	T38415
VITO		TENSOR- MOTOR	T38415
4 CIL. 2.2 L CDI		BANDA-MOTOR	K060888
2013		BANDA-MOTOR	K060888
TERMOSTATO-	TH35087G1	BANDA-MOTOR	K060900
TERMOSTATO-	TH35087G1	BANDA-MOTOR	K060900
TENSOR- MOTOR	T38415	BANDA-MOTOR	6469MC
TENSOR- MOTOR	T38415	BANDA-MOTOR	6469MC
BANDA-MOTOR	K060888	POLEA-MOTOR	38099
BANDA-MOTOR	K060888	POLEA-MOTOR	38099
BANDA-MOTOR	K060900		
BANDA-MOTOR	K060900	2010	
BANDA-MOTOR	6469MC	TERMOSTATO-	TH35087G1
BANDA-MOTOR	6469MC	TERMOSTATO-	TH35087G1
POLEA-MOTOR	38099	TENSOR- MOTOR	T38415
POLEA-MOTOR	38099	TENSOR- MOTOR	T38415
2012		TERMOSTATO-189°	TH35087G1
TERMOSTATO-	TH35087G1	TERMOSTATO-189°	TH35087G1
TERMOSTATO-	TH35087G1	BANDA-MOTOR	K060888
TENSOR- MOTOR	T38415	BANDA-MOTOR	K060888
		BANDA-MOTOR	K060900



MASTER SERVICIO PESADO 2014

MERCEDES BENZ

VITO

BANDA-MOTOR	K060900	MANGUERA SUPERIOR-	CH-180031
BANDA-MOTOR	6469MC	BANDA-ALT	6366L
BANDA-MOTOR	6469MC	BANDA-ÁRBOL DE LEVAS	CADENA
POLEA-MOTOR	38099	BANDA-DH	8452L
POLEA-MOTOR	38099	2004	
2009		MANGUERA INFERIOR-	CH-180042
TERMOSTATO-	TH35087G1	MANGUERA SUPERIOR-	CH-180031
TERMOSTATO-	TH35087G1	BANDA-ALT	6366L
TENSOR- MOTOR	T38415	BANDA-ÁRBOL DE LEVAS	CADENA
TENSOR- MOTOR	T38415	BANDA-DH	8452L
TERMOSTATO-189°	TH35087G1	2003	
TERMOSTATO-189°	TH35087G1	MANGUERA INFERIOR-	CH-180042
BANDA-MOTOR	K060888	MANGUERA SUPERIOR-	CH-180031
BANDA-MOTOR	K060888	BANDA-ALT	6366L
BANDA-MOTOR	K060900	BANDA-ÁRBOL DE LEVAS	CADENA
BANDA-MOTOR	K060900	BANDA-DH	8452L
BANDA-MOTOR	6469MC	2002	
BANDA-MOTOR	6469MC	MANGUERA INFERIOR-	CH-180042
POLEA-MOTOR	38099	MANGUERA SUPERIOR-	CH-180031
POLEA-MOTOR	38099	BANDA-ALT	6366L

NISSAN



UTILITARIOS

CHASIS

4 CIL, 2.4 L

2006

MANGUERA INFERIOR-	CH-180042	MANGUERA INFERIOR-	CH-180042
MANGUERA SUPERIOR-	CH-180031	MANGUERA SUPERIOR-	CH-180031
BANDA-ALT	6366L	BANDA-ALT	6366L
BANDA-ÁRBOL DE LEVAS	CADENA	BANDA-ÁRBOL DE LEVAS	CADENA
BANDA-DH	8452L	BANDA-DH	8452L

2000

2005

MANGUERA INFERIOR-	CH-180042	MANGUERA INFERIOR-	CH-180042
		MANGUERA SUPERIOR-	CH-180031
		BANDA-ALT	6366L



MASTER SERVICIO PESADO 2014

NISSAN

CHASIS

BANDA-ÁRBOL DE LEVAS	CADENA	BANDA-DH	9455
BANDA-DH	8452L	2008	
1999		MANGUERA INFERIOR-	CH-180202
MANGUERA INFERIOR-	CH-180042	BANDA-ALT	6366L
MANGUERA SUPERIOR-	CH-180031	BANDA-COMPRESOR	9365
BANDA-ALT	6366L	BANDA-DH	9455
BANDA-ÁRBOL DE LEVAS	CADENA	2007	
BANDA-DH	8452L	MANGUERA INFERIOR-	CH-180202
1998		BANDA-ALT	6366L
MANGUERA INFERIOR-	CH-180042	BANDA-COMPRESOR	9365
MANGUERA SUPERIOR-	CH-180031	BANDA-DH	9455
BANDA-ALT	6366L	2006	
BANDA-ÁRBOL DE LEVAS	CADENA	MANGUERA INFERIOR-	CH-180202
BANDA-DH	8452L	BANDA-ALT	6366L
1997		BANDA-COMPRESOR	9365
BANDA-ALT	6366L	BANDA-DH	9455
BANDA-ÁRBOL DE LEVAS	CADENA	2005	
BANDA-DH	8452L	MANGUERA INFERIOR-	CH-180202
1996		BANDA-ALT	6366L
BANDA-ALT	6366L	BANDA-COMPRESOR	9365
BANDA-ÁRBOL DE LEVAS	CADENA	BANDA-DH	9455
BANDA-DH	8452L	2004	
1995		MANGUERA INFERIOR-	CH-180202
BANDA-ALT	6366L	BANDA-ALT	6366L
BANDA-ÁRBOL DE LEVAS	CADENA	BANDA-ÁRBOL DE LEVAS	CADENA
BANDA-DH	8452L	BANDA-COMPRESOR	9365
ESTAQUITAS		BANDA-DH	9455
4 CIL, 2.4 L		2003	
2009		BANDA-ALT	6366L
MANGUERA INFERIOR-	CH-180202	BANDA-ÁRBOL DE LEVAS	CADENA
BANDA-ALT	6366L	BANDA-COMPRESOR	9365
BANDA-COMPRESOR	9365	BANDA-DH	9455



MASTER SERVICIO PESADO 2014

NISSAN

ESTAQUITAS

2002

MANGUERA INFERIOR-	CH-180202	BANDA-ÁRBOL DE LEVAS	CADENA
BANDA-ALT	6366L	BANDA-DH	8452L
BANDA-ÁRBOL DE LEVAS	CADENA	MANGUERA INFERIOR-	CH-180202
BANDA-COMPRESOR	9365	BANDA-ALT	6366L
BANDA-DH	9455	BANDA-ÁRBOL DE LEVAS	CADENA

2001

MANGUERA INFERIOR-	CH-180042	BANDA-DH	8452L
MANGUERA INFERIOR-	CH-180202	1997	
MANGUERA SUPERIOR-	CH-180031	MANGUERA INFERIOR-	CH-180202
BANDA-ALT	6366L	TAPÓN DE RADIADOR-(13 LBS) CON PALANCA	31533
BANDA-ÁRBOL DE LEVAS	CADENA	TAPÓN DE RADIADOR-(13 LBS) SIN PALANCA	31333
BANDA-DH	8452L	BANDA-ALT	6366L
		BANDA-ÁRBOL DE LEVAS	CADENA

2000

MANGUERA INFERIOR-	CH-180042	BANDA-DH	8452L
MANGUERA INFERIOR-	CH-180202	1995	
MANGUERA SUPERIOR-	CH-180031	MANGUERA INFERIOR-	CH-180202
BANDA-ALT	6366L	TAPÓN DE RADIADOR-(13 LBS) CON PALANCA	31533
BANDA-ÁRBOL DE LEVAS	CADENA	TAPÓN DE RADIADOR-(13 LBS) SIN PALANCA	31333
BANDA-DH	8452L	BANDA-ALT	6366L
		BANDA-ÁRBOL DE LEVAS	CADENA

1999

MANGUERA INFERIOR-	CH-180042	BANDA-DH	8452L
MANGUERA INFERIOR-	CH-180202	4 CIL, 1.8 L	
MANGUERA SUPERIOR-	CH-180031	1994	
BANDA-ALT	6366L	MANGUERA INFERIOR-	CH-181222
BANDA-ÁRBOL DE LEVAS	CADENA	MANGUERA INFERIOR FLEXIBLE-	12T202
BANDA-DH	8452L	MANGUERA SUPERIOR-	CH-181001
		TAPÓN DE RADIADOR-(13 LBS) CON PALANCA	31533
		TAPÓN DE RADIADOR-(13 LBS) SIN PALANCA	31333

1998

MANGUERA INFERIOR-	CH-180042	BANDA-ALT	6400 GS
MANGUERA INFERIOR-	CH-180202	BANDA-ÁRBOL DE LEVAS	CADENA
MANGUERA SUPERIOR-	CH-180031	1993	
BANDA-ALT	6366L	MANGUERA INFERIOR-	CH-181222



MASTER SERVICIO PESADO 2014

NISSAN

ESTAQUITAS

MANGUERA INFERIOR FLEXIBLE-	12T202	TAPÓN DE RADIADOR-13 LBS.	31333
MANGUERA SUPERIOR-	CH-181001	BANDA-ALT	AX39
TAPÓN DE RADIADOR-(13 LBS) CON PALANCA	31533	BANDA-COMPRESOR	8355GS
TAPÓN DE RADIADOR-(13 LBS) SIN PALANCA	31333	2008	
BANDA-ALT	6400 GS	MANGUERA INFERIOR-	CH-180302
BANDA-ÁRBOL DE LEVAS	CADENA	MANGUERA SUPERIOR-	CH-180301
NP300		TAPÓN DE RADIADOR-13 LBS.	31333
4 CIL. 2.5 L DIESEL		BANDA-ALT	AX39
2013		BANDA-COMPRESOR	8355GS
BANDA-ALT	AX39	4 CIL. 2.4 L	
BANDA-COMPRESOR	8355GS	2013	
2012		BANDA-ALT	6366L
MANGUERA INFERIOR-	CH-180302	BANDA-COMPRESOR	9365L
MANGUERA SUPERIOR-	CH-180301	BANDA-DH	9490L
TAPÓN DE RADIADOR-13 LBS.	31333	2012	
BANDA-ALT	AX39	MANGUERA INFERIOR-	CH-180102
BANDA-COMPRESOR	8355GS	MANGUERA SUPERIOR-	CH-180101
2011		TAPÓN DE RADIADOR-13 LBS.	31333
MANGUERA INFERIOR-	CH-180302	BANDA-ALT	6366L
MANGUERA SUPERIOR-	CH-180301	BANDA-COMPRESOR	9365L
TAPÓN DE RADIADOR-13 LBS.	31333	BANDA-DH	9490L
BANDA-ALT	AX39	2011	
BANDA-COMPRESOR	8355GS	MANGUERA INFERIOR-	CH-180102
2010		MANGUERA SUPERIOR-	CH-180101
MANGUERA INFERIOR-	CH-180302	TAPÓN DE RADIADOR-13 LBS.	31333
MANGUERA SUPERIOR-	CH-180301	BANDA-ALT	6366L
TAPÓN DE RADIADOR-13 LBS.	31333	BANDA-COMPRESOR	9365L
BANDA-ALT	AX39	BANDA-DH	9490L
BANDA-COMPRESOR	8355GS	2010	
2009		MANGUERA INFERIOR-	CH-180102
MANGUERA INFERIOR-	CH-180302	MANGUERA SUPERIOR-	CH-180101
MANGUERA SUPERIOR-	CH-180301	TAPÓN DE RADIADOR-13 LBS.	31333



MASTER SERVICIO PESADO 2014

NISSAN

NP300

BANDA-ALT	6366L	TAPÓN DE GASOLINA-SIN LLAVE	31832
BANDA-COMPRESOR	9365L	2013	
BANDA-DH	9490L	TAPÓN DE GASOLINA-CON LLAVE	31780
2009		BANDA-MOTOR	K070873
MANGUERA INFERIOR-	CH-180102	POLEA-MOTOR	36222
MANGUERA SUPERIOR-	CH-180101	TENSOR-MOTOR	38378
TAPÓN DE RADIADOR-13 LBS.	31333	TAPÓN DE GASOLINA-SIN LLAVE	31832
BANDA-ALT	6366L	PICK-UP	
BANDA-COMPRESOR	9365L	4 CIL, 2.4 L	
BANDA-DH	9490L	2007	
2008		MANGUERA INFERIOR-	CH-180202
MANGUERA INFERIOR-	CH-180102	BANDA-ALT	6366L
MANGUERA SUPERIOR-	CH-180101	BANDA-COMPRESOR	9365
TAPÓN DE RADIADOR-13 LBS.	31333	BANDA-DH	9455
BANDA-ALT	6366L	2006	
BANDA-COMPRESOR	9365L	MANGUERA INFERIOR-	CH-180202
BANDA-DH	9490L	BANDA-ALT	6366L
NV2500		BANDA-COMPRESOR	9365
V8, 5.6 L		BANDA-DH	9455
2014		2005	
TAPÓN DE GASOLINA-CON LLAVE	31780	MANGUERA INFERIOR-	CH-180202
BANDA-MOTOR	K070961	BANDA-ALT	6366L
TAPÓN DE GASOLINA-SIN LLAVE	31832	BANDA-COMPRESOR	9365
2013		BANDA-DH	9455
TAPÓN DE GASOLINA-CON LLAVE	31780	2004	
BANDA-MOTOR	K070961	MANGUERA INFERIOR-	CH-180202
TAPÓN DE GASOLINA-SIN LLAVE	31832	BANDA-ALT	6366L
V6, 4.0 L		BANDA-ÁRBOL DE LEVAS	CADENA
2014		BANDA-COMPRESOR	9365
TAPÓN DE GASOLINA-CON LLAVE	31780	BANDA-DH	9455
BANDA-MOTOR	K070873	2003	
POLEA-MOTOR	36222	MANGUERA INFERIOR-	CH-180202
TENSOR-MOTOR	38378		



MASTER SERVICIO PESADO 2014

NISSAN

PICK-UP

BANDA-ALT	6366L	MANGUERA INFERIOR-	CH-180202
BANDA-ÁRBOL DE LEVAS	CADENA	TERMOSTATO-170°	33747
BANDA-COMPRESOR	9365	BANDA-ALT	6366L
BANDA-DH	9455	BANDA-ÁRBOL DE LEVAS	CADENA
2002		BANDA-DH	8452L
MANGUERA INFERIOR-	CH-180202	POLEA-DH	38036
BANDA-ALT	6366L	1996	
BANDA-ÁRBOL DE LEVAS	CADENA	BOMBA DE DIR. HIDR.-	BDH-5155
BANDA-COMPRESOR	9365	MANGUERA INFERIOR-	CH-180202
BANDA-DH	9455	TAPÓN DE RADIADOR-(13 LBS) CON PALANCA	31533
2001		TAPÓN DE RADIADOR-(13 LBS) SIN PALANCA	31333
MANGUERA INFERIOR-	CH-180202	TERMOSTATO-170°	33747
BANDA-ALT	6366L	BANDA-ALT	6366L
BANDA-ÁRBOL DE LEVAS	CADENA	BANDA-ÁRBOL DE LEVAS	CADENA
BANDA-DH	8452L	BANDA-DH	8452L
2000		POLEA-DH	38036
MANGUERA INFERIOR-	CH-180202	1995	
BANDA-ALT	6366L	BOMBA DE DIR. HIDR.-	BDH-5155
BANDA-ÁRBOL DE LEVAS	CADENA	MANGUERA INFERIOR-	CH-180202
BANDA-DH	8452L	TAPÓN DE ACEITE-	31115
1999		TAPÓN DE RADIADOR-(13 LBS) CON PALANCA	31533
MANGUERA INFERIOR-	CH-180202	TAPÓN DE RADIADOR-(13 LBS) SIN PALANCA	31333
BANDA-ALT	6366L	TERMOSTATO-170°	33747
BANDA-ÁRBOL DE LEVAS	CADENA	BANDA-ALT	6366L
BANDA-DH	8452L	BANDA-ÁRBOL DE LEVAS	CADENA
1998		BANDA-DH	8452L
MANGUERA INFERIOR-	CH-180202	POLEA-DH	38036
BANDA-ALT	6366L	1994	
BANDA-ÁRBOL DE LEVAS	CADENA	BOMBA DE DIR. HIDR.-	BDH-5155
BANDA-DH	8452L	MANGUERA INFERIOR-	CH-180202
1997		MANGUERA SUPERIOR-	CH-180041
BOMBA DE DIR. HIDR.-	BDH-5155	MANGUERA SUPERIOR FLEXIBLE-	12T150



MASTER SERVICIO PESADO 2014

NISSAN

PICK-UP

TAPÓN DE ACEITE-	31115	BANDA-MOTOR	K070840
TAPÓN DE RADIADOR-(13 LBS) CON PALANCA	31533	2011	
TAPÓN DE RADIADOR-(13 LBS) SIN PALANCA	31333	TAPÓN DE RADIADOR-(13 LBS) SIN PALANCA	31333
TERMOSTATO-170°	33747	TERMOSTATO-190°	TH12988G1
BANDA-ALT	7370	MANGUERA SUPERIOR-21501VZ00A	CH-180151
BANDA-ÁRBOL DE LEVAS	CADENA	MANGUERA INFERIOR-21503VZ00A	CH-180142
BANDA-DH	8360 GS	BANDA-MOTOR	K070840
POLEA-DH	38036	2010	
1993		TAPÓN DE RADIADOR-(13 LBS) SIN PALANCA	31333
TAPÓN DE ACEITE-	31115	TERMOSTATO-190°	TH12988G1
BOMBA DE DIR. HIDR.-	BDH-5155	MANGUERA SUPERIOR-21501VZ00A	CH-180151
MANGUERA SUPERIOR-	CH-180041	MANGUERA INFERIOR-21503VZ00A	CH-180142
MANGUERA SUPERIOR FLEXIBLE-	12T150	BANDA-MOTOR	K070840
TAPÓN DE RADIADOR-(13 LBS) CON PALANCA	31511	2009	
TERMOSTATO-170°	33747	TAPÓN DE RADIADOR-(13 LBS) SIN PALANCA	31333
BANDA-ALT	7370	TERMOSTATO-190°	TH12988G1
BANDA-ÁRBOL DE LEVAS	CADENA	MANGUERA SUPERIOR-21501VZ00A	CH-180151
BANDA-DH	8360 GS	MANGUERA INFERIOR-21503VZ00A	CH-180142
POLEA-DH	38036	BANDA-MOTOR	K070840
URVAN		4 CIL, 3.0 L DIESEL	
4 CIL. 2.5 L		2013	
2013		MANGUERA INFERIOR-	CH-180172
TAPÓN DE RADIADOR-(13 LBS) SIN PALANCA	31333	MANGUERA SUPERIOR-	CH-180171
TERMOSTATO-190°	TH12988G1	TAPÓN DE RADIADOR-(13 LBS) SIN PALANCA	31333
MANGUERA SUPERIOR-21501VZ00A	CH-180151	BANDA-SERPENTIN	K070694
MANGUERA INFERIOR-21503VZ00A	CH-180142	2012	
BANDA-MOTOR	K070840	MANGUERA INFERIOR-	CH-180172
2012		MANGUERA SUPERIOR-	CH-180171
TAPÓN DE RADIADOR-(13 LBS) SIN PALANCA	31333	TAPÓN DE RADIADOR-(13 LBS) SIN PALANCA	31333
TERMOSTATO-190°	TH12988G1	BANDA-SERPENTIN	K070694
MANGUERA SUPERIOR-21501VZ00A	CH-180151	2011	
MANGUERA INFERIOR-21503VZ00A	CH-180142	MANGUERA INFERIOR-	CH-180172



MASTER SERVICIO PESADO 2014

NISSAN

URVAN

MANGUERA SUPERIOR-	CH-180171	MANGUERA INFERIOR-	CH-180152
TAPÓN DE RADIADOR-(13 LBS) SIN PALANCA	31333	MANGUERA SUPERIOR-	CH-180141
BANDA-SERPENTIN	K070694	BANDA-AA	K040354
2010		BANDA-ÁRBOL DE LEVAS	CADENA
MANGUERA INFERIOR-	CH-180172	BANDA-DH	K040490
MANGUERA SUPERIOR-	CH-180171	BANDA-SERPENTIN	K040360
TAPÓN DE RADIADOR-(13 LBS) SIN PALANCA	31333	2005	
BANDA-SERPENTIN	K070694	BOMBA DE DIR. HIDR.-	BDH-5535
2009		MANGUERA INFERIOR-	CH-180141
MANGUERA INFERIOR-	CH-180172	MANGUERA INFERIOR-	CH-180152
MANGUERA SUPERIOR-	CH-180171	BANDA-AA	K040354
TAPÓN DE RADIADOR-(13 LBS) SIN PALANCA	31333	BANDA-ÁRBOL DE LEVAS	CADENA
BANDA-SERPENTIN	K070694	BANDA-DH	K040490
4 CIL, 2.4 L		BANDA-SERPENTIN	K040360
2008		2004	
BOMBA DE DIR. HIDR.-	BDH-5535	BOMBA DE DIR. HIDR.-	BDH-5535
MANGUERA INFERIOR-	CH-180152	MANGUERA INFERIOR-	CH-180152
MANGUERA SUPERIOR-	CH-180141	MANGUERA SUPERIOR-	CH-180141
BANDA-AA	K040354	BANDA-AA	K040354
BANDA-ÁRBOL DE LEVAS	CADENA	BANDA-ALT	K040360
BANDA-DH	K040490	BANDA-ÁRBOL DE LEVAS	CADENA
BANDA-SERPENTIN	K040360	BANDA-DH	K040490
2007		2003	
BOMBA DE DIR. HIDR.-	BDH-5535	BOMBA DE DIR. HIDR.-	BDH-5535
MANGUERA INFERIOR-	CH-180152	MANGUERA INFERIOR-	CH-180152
MANGUERA SUPERIOR-	CH-180141	MANGUERA SUPERIOR-	CH-180141
BANDA-AA	K040354	BANDA-AA	K040354
BANDA-ÁRBOL DE LEVAS	CADENA	BANDA-ALT	K040360
BANDA-DH	K040490	BANDA-ÁRBOL DE LEVAS	CADENA
BANDA-SERPENTIN	K040360	BANDA-DH	K040490
2006		2002	
BOMBA DE DIR. HIDR.-	BDH-5535	BOMBA DE DIR. HIDR.-	BDH-5535



MASTER SERVICIO PESADO 2014

NISSAN

URVAN

MANGUERA INFERIOR-	CH-180152	BANDA-ÁRBOL DE LEVAS (116D X 25.4MM)	T1603
MANGUERA SUPERIOR-	CH-180141	BANDA-SERPENTIN	K060480
BANDA-AA	K040354	2008	
BANDA-ALT	K040360	TAPÓN DE RADIADOR-	RC218
BANDA-ÁRBOL DE LEVAS	CADENA	BANDA-ÁRBOL DE LEVAS (116D X 25.4MM)	T1603
BANDA-DH	K040490	BANDA-SERPENTIN	K060480

2001

BOMBA DE DIR. HIDR.-	BDH-5535	MANAGER	
MANGUERA INFERIOR-	CH-180152	4 CIL, 3.0 L DIESEL	
MANGUERA SUPERIOR-	CH-180141	2013	
BANDA-AA	K040354	TAPÓN DE RADIADOR-(20 LBS) SIN PALANCA	RC216
BANDA-ALT	K040360	BANDA STRETCH FIT-AA	4PK1102SF
BANDA-ÁRBOL DE LEVAS	CADENA	POLEA-AA	T36402
BANDA-DH	K040490	TENSOR-MOTOR	T39137
		BANDA STRETCH FIT-SERPENTIN	K060458

2000

BOMBA DE DIR. HIDR.-	BDH-5535	2012	
MANGUERA INFERIOR-	CH-180152	TAPÓN DE RADIADOR-(20 LBS) SIN PALANCA	RC216
MANGUERA SUPERIOR-	CH-180141	BANDA STRETCH FIT-AA	4PK1102SF
BANDA-AA	K040354	POLEA-AA	T36402
BANDA-ALT	K040360	TENSOR-MOTOR	T39137
BANDA-ÁRBOL DE LEVAS	CADENA	BANDA STRETCH FIT-SERPENTIN	K060458
BANDA-DH	K040490		

PEUGEOT



UTILITARIOS

EXPERT

4 CIL, 2.0 L HDI

2010

TAPÓN DE RADIADOR-	RC218	2010	
BANDA-ÁRBOL DE LEVAS (116D X 25.4MM)	T1603	TAPÓN DE RADIADOR-(20 LBS) SIN PALANCA	RC216
BANDA-SERPENTIN	K060480	BANDA STRETCH FIT-AA	4PK1102SF
		POLEA-AA	T36402
		TENSOR-MOTOR	T39137
		BANDA STRETCH FIT-SERPENTIN	K060458

2009

TAPÓN DE RADIADOR-	RC218		
--------------------	-------	--	--



MASTER SERVICIO PESADO 2014

PEUGEOT

MANAGER

2009		BANDA-C/AA	K060672
TAPÓN DE RADIADOR-(20 LBS) SIN PALANCA	RC216	BANDA-S/AA	K060535
BANDA STRETCH FIT-AA	4PK1102SF	4 CIL, 1.6 L DIESEL	
POLEA-AA	T36402	2011	
TENSOR-MOTOR	T39137	BANDA-ÁRBOL DE LEVAS (137D X 25MM)	5598XS
BANDA-SERPENTIN	K060458	BANDA-C/AA	K060672
		BANDA-S/AA	K060535
2008		2010	
TAPÓN DE RADIADOR-(20 LBS) SIN PALANCA	RC216	BANDA-ÁRBOL DE LEVAS (137D X 25MM)	5598XS
BANDA STRETCH FIT-AA	4PK1102SF	BANDA-C/AA	K060672
POLEA-AA	T36402	BANDA-S/AA	K060535
TENSOR-MOTOR	T39137	2009	
BANDA-SERPENTIN	K060458	BANDA-ÁRBOL DE LEVAS (137D X 25MM)	5598XS
4 CIL, 2.2 L DIESEL		BANDA-C/AA	K060672
2014		BANDA-S/AA	K060535
TAPÓN DE RADIADOR-	RC216	4 CIL, 1.6 L	
TERMOSTATO-	TH26988G1	2011	
POLEA-AA	T36124	TERMOSTATO-	TH21689G1
TENSOR-AA	T39107	BANDA-ÁRBOL DE LEVAS {134 D x 25.4 MM}	T1581
BANDA-C/AA	K060653	BANDA-C/AA	K060615
BANDA STRETCH FIT-DH	4PK922SF	2010	
BANDA STRETCH FIT-S/AA	6PK873SF	TERMOSTATO-	TH21689G1
2013		BANDA-ÁRBOL DE LEVAS {134 D x 25.4 MM}	T1581
TAPÓN DE RADIADOR-	RC216	BANDA-C/AA	K060615
TERMOSTATO-	TH26988G1	2009	
POLEA-AA	T36124	TERMOSTATO-	TH21689G1
TENSOR-AA	T39107	BANDA-ÁRBOL DE LEVAS {134 D x 25.4 MM}	T1581
BANDA-C/AA	K060653	BANDA-C/AA	K060615
BANDA STRETCH FIT-DH	4PK922SF	2008	
BANDA STRETCH FIT-S/AA	6PK873SF	TERMOSTATO-	TH21689G1
PARTNER		BANDA-ÁRBOL DE LEVAS {134 D x 25.4 MM}	T1581
4 CIL, 1.6 L HDI		BANDA-C/AA	K060615
2008		2007	
BANDA-ÁRBOL DE LEVAS (137D X 25MM)	5598XS		

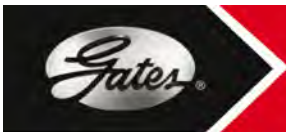

MASTER SERVICIO PESADO 2014

PEUGEOT

PARTNER



TERMOSTATO-	TH21689G1
BANDA-ÁRBOL DE LEVAS {134 D x 25.4 MM}	T1581
BANDA-C/AA	K060615

2006

TERMOSTATO-	TH21689G1
BANDA-ÁRBOL DE LEVAS {134 D x 25.4 MM}	T1581
BANDA-C/AA	K060615

2005

TERMOSTATO-	TH21689G1
BANDA-ÁRBOL DE LEVAS {134 D x 25.4 MM}	T1581
BANDA-S/AA	K060615

2004

TERMOSTATO-	TH21689G1
BANDA-ÁRBOL DE LEVAS {134 D x 25.4 MM}	T1581
BANDA-C/AA	K060615

PARTNER MAXI

4 CIL, 1.6 L TURBO DIESEL

2014

TAPÓN DE RADIADOR-	RC218
BANDA-ÁRBOL DE LEVAS {141 D x 25.4 MM}	T1663
BANDA-C/AA	K060384
BANDA-S/AA	K060316

2013

TAPÓN DE RADIADOR-	RC218
BANDA-ÁRBOL DE LEVAS {141 D x 25.4 MM}	T1663
BANDA-C/AA	K060384
BANDA-S/AA	K060316

2012

TAPÓN DE RADIADOR-	RC218
BANDA-ÁRBOL DE LEVAS {141 D x 25.4 MM}	T1663
BANDA-C/AA	K060384
BANDA-S/AA	K060316

RENAULT

UTILITARIOS

KANGOO

4 CIL, 1.6 L

2013

MANGUERA INFERIOR-	CH-180182
MANGUERA SUPERIOR-	CH-180191
TERMOSTATO-190°	TH23389G1
KIT-ÁRBOL DE LEVAS	TCK1095M
KIT CON BOMBA DE AGUA-ÁRBOL DE LEVAS	TCKWP1095M
TENSOR-ÁRBOL DE LEVAS	T43064
BANDA-ÁRBOL DE LEVAS {132 D x 27 MM}	T1095
BANDA-C/AA	K050688
BANDA-S/AA	K050435

2012

MANGUERA INFERIOR-	CH-180182
MANGUERA SUPERIOR-	CH-180191
TERMOSTATO-190°	TH23389G1
KIT-ÁRBOL DE LEVAS	TCK1095M
KIT CON BOMBA DE AGUA-ÁRBOL DE LEVAS	TCKWP1095M
TENSOR-ÁRBOL DE LEVAS	T43064
BANDA-ÁRBOL DE LEVAS {132 D x 27 MM}	T1095
BANDA-C/AA	K050688
BANDA-S/AA	K050435

2011

MANGUERA INFERIOR-	CH-180182
MANGUERA SUPERIOR-	CH-180191
TERMOSTATO-190°	TH23389G1
KIT-ÁRBOL DE LEVAS	TCK1095M
KIT CON BOMBA DE AGUA-ÁRBOL DE LEVAS	TCKWP1095M
TENSOR-ÁRBOL DE LEVAS	T43064
BANDA-ÁRBOL DE LEVAS {132 D x 27 MM}	T1095



MASTER SERVICIO PESADO 2014

RENAULT

KANGOO

BANDA-C/AA	K050688	2007	
BANDA-S/AA	K050435	MANGUERA INFERIOR-	CH-180182
2010		MANGUERA SUPERIOR-	CH-180191
MANGUERA INFERIOR-	CH-180182	TERMOSTATO-190°	TH23389G1
MANGUERA SUPERIOR-	CH-180191	KIT CON BOMBA DE AGUA-ÁRBOL DE LEVAS	TCKWP1095M
TERMOSTATO-190°	TH23389G1	TENSOR-ÁRBOL DE LEVAS	T43064
KIT-ÁRBOL DE LEVAS	TCK1095M	BANDA-ÁRBOL DE LEVAS {132 D x 27 MM}	T1095
KIT CON BOMBA DE AGUA-ÁRBOL DE LEVAS	TCKWP1095M	BANDA-C/AA	K050688
TENSOR-ÁRBOL DE LEVAS	T43064	BANDA-S/AA	K050435
BANDA-ÁRBOL DE LEVAS {132 D x 27 MM}	T1095	2006	
BANDA-C/AA	K050688	MANGUERA INFERIOR-	CH-180182
BANDA-S/AA	K050435	MANGUERA SUPERIOR-	CH-180191
2009		TERMOSTATO-190°	TH23389G1
MANGUERA INFERIOR-	CH-180182	KIT CON BOMBA DE AGUA-ÁRBOL DE LEVAS	TCKWP1095M
MANGUERA SUPERIOR-	CH-180191	TENSOR-ÁRBOL DE LEVAS	T43064
TERMOSTATO-190°	TH23389G1	BANDA-ÁRBOL DE LEVAS {132 D x 27 MM}	T1095
KIT-ÁRBOL DE LEVAS	TCK1095M	BANDA-C/AA	K050688
KIT CON BOMBA DE AGUA-ÁRBOL DE LEVAS	TCKWP1095M	BANDA-S/AA	K050435
TENSOR-ÁRBOL DE LEVAS	T43064	2005	
BANDA-ÁRBOL DE LEVAS {132 D x 27 MM}	T1095	MANGUERA INFERIOR-	CH-180182
BANDA-C/AA	K050688	MANGUERA SUPERIOR-	CH-180191
BANDA-S/AA	K050435	TERMOSTATO-190°	TH23389G1
2008		KIT CON BOMBA DE AGUA-ÁRBOL DE LEVAS	TCKWP1095M
MANGUERA INFERIOR-	CH-180182	TENSOR-ÁRBOL DE LEVAS	T43064
MANGUERA SUPERIOR-	CH-180191	BANDA-ÁRBOL DE LEVAS {132 D x 27 MM}	T1095
TERMOSTATO-190°	TH23389G1	BANDA-C/AA	K050688
KIT-ÁRBOL DE LEVAS	TCK1095M	BANDA-S/AA	K050435
KIT CON BOMBA DE AGUA-ÁRBOL DE LEVAS	TCKWP1095M	KANGOO EXPRESS	
TENSOR-ÁRBOL DE LEVAS	T43064	4 CIL, 1.6 L	
BANDA-ÁRBOL DE LEVAS {132 D x 27 MM}	T1095	2008	
BANDA-C/AA	K050688	MANGUERA INFERIOR-	CH-180182
BANDA-S/AA	K050435	MANGUERA SUPERIOR-	CH-180191

TRANSPORTE



Mangueras de Silicón Milimétricas para Camiones y Autobuses VOLVO



SIHVLVGATES744



SIHVLVGATES576



SIHVLVGATES477



SIHVLVGATES081



SIHVLVGATES199



SIHVLVGATES971



SIHVLVGATES924



OE	DIMENSIONES	NÚMERO GATES
1676744	Turbo 69 DI mm x 263 mm / 7 anillos con bridas	SIHVLVGATES744
1195576	Codo 90° 58 mm DI x 110 mm x 110 mm	SIHVLVGATES576
3031477	Codo 90° 58 mm DI x 200 mm x 110 mm	SIHVLVGATES477
1195081	Recta 60 mm DI x 160 mm	SIHVLVGATES081
1676199	Turbo 101 mm DI x 94 mm / 2 anillos y terminales metálicas	SIHVLVGATES199
1665971	Turbo 86 mm DI x 250 mm / 6 anillos con bridas	SIHVLVGATES971
20463924	Turbo 98 mm DI x 145 mm / 4 anillos y terminales metálicas	SIHVLVGATES924





MASTER SERVICIO PESADO 2014

RENAULT

KANGOO EXPRESS

TERMOSTATO-190°	TH23389G1	BANDA-C/AA	K050688
KIT-ÁRBOL DE LEVAS	TCK1095M	BANDA-S/AA	K050435
KIT CON BOMBA DE AGUA-ÁRBOL DE LEVAS	TCKWP1095M	TRAFIC	
TENSOR-ÁRBOL DE LEVAS	T43064	4 CIL, 1.9 L DIESEL	
BANDA-ÁRBOL DE LEVAS {132 D x 27 MM}	T1095	2009	
BANDA-C/AA	K050688	TENSOR-ÁRBOL DE LEVAS	T41240
BANDA-S/AA	K050435	BANDA-ÁRBOL DE LEVAS (132D X 26MM)	T1558
2007		BANDA-C/AA	K050446
MANGUERA INFERIOR-	CH-180182	BANDA-S/AA	K060708
MANGUERA SUPERIOR-	CH-180191	2008	
TERMOSTATO-190°	TH23389G1	TENSOR-ÁRBOL DE LEVAS	T41240
KIT CON BOMBA DE AGUA-ÁRBOL DE LEVAS	TCKWP1095M	BANDA-ÁRBOL DE LEVAS {132 D x 26 MM}	T1558
TENSOR-ÁRBOL DE LEVAS	T43064	BANDA-C/AA	K050446
BANDA-ÁRBOL DE LEVAS {132 D x 27 MM}	T1095	BANDA-S/AA	K060708
BANDA-C/AA	K050688	TOYOTA	
BANDA-S/AA	K050435		
2006		UTILITARIOS	
MANGUERA INFERIOR-	CH-180182	HIACE	
MANGUERA SUPERIOR-	CH-180191	4 CIL. 2.7 L	
TERMOSTATO-190°	TH23389G1	2013	
KIT CON BOMBA DE AGUA-ÁRBOL DE LEVAS	TCKWP1095M	MANGUERA SUPERIOR-	CH-150101
TENSOR-ÁRBOL DE LEVAS	T43064	BANDA-C/AA	K070901
BANDA-ÁRBOL DE LEVAS {132 D x 27 MM}	T1095	MANGUERA INFERIOR-CARROCERÍA CORTA	CH-150102
BANDA-C/AA	K050688	MANGUERA INFERIOR-CARROCERÍA LARGA	CH-150112
BANDA-S/AA	K050435	BANDA-S/AA	K070735
2005		2012	
MANGUERA INFERIOR-	CH-180182	MANGUERA SUPERIOR-	CH-150101
MANGUERA SUPERIOR-	CH-180191	MANGUERA SUPERIOR-	CH-150101
TERMOSTATO-190°	TH23389G1	BANDA-C/AA	K070901
KIT CON BOMBA DE AGUA-ÁRBOL DE LEVAS	TCKWP1095M	MANGUERA INFERIOR-CABINA CORTA	CH-150102
TENSOR-ÁRBOL DE LEVAS	T43064	MANGUERA INFERIOR-CABINA LARGA	CH-150112
BANDA-ÁRBOL DE LEVAS {132 D x 27 MM}	T1095	MANGUERA INFERIOR-CARROCERÍA CORTA	CH-150102
		MANGUERA INFERIOR-CARROCERÍA LARGA	CH-150112

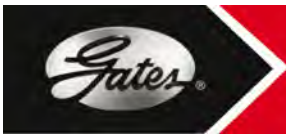

MASTER SERVICIO PESADO 2014

TOYOTA

HIACE

BANDA-S/AA	K070735	2007	
2011			
MANGUERA SUPERIOR-	CH-150101	MANGUERA SUPERIOR-	CH-150101
MANGUERA SUPERIOR-	CH-150101	BDH-	BDH-5587
BANDA-C/AA	K070901	BANDA-C/AA	K070901
MANGUERA INFERIOR-CABINA CORTA	CH-150102	MANGUERA INFERIOR-CABINA CORTA	CH-150102
MANGUERA INFERIOR-CABINA LARGA	CH-150112	MANGUERA INFERIOR-CABINA LARGA	CH-150112
MANGUERA INFERIOR-CARROCERÍA CORTA	CH-150102	MANGUERA INFERIOR-CARROCERÍA CORTA	CH-150102
MANGUERA INFERIOR-CARROCERÍA LARGA	CH-150112	MANGUERA INFERIOR-CARROCERÍA LARGA	CH-150112
BANDA-S/AA	K070735	BANDA-S/AA	K070735
2010		2006	
MANGUERA SUPERIOR-	CH-150101	MANGUERA SUPERIOR-	CH-150101
BANDA-C/AA	K070901	MANGUERA SUPERIOR-	CH-150101
MANGUERA INFERIOR-CARROCERÍA CORTA	CH-150102	BDH-	BDH-5587
MANGUERA INFERIOR-CARROCERÍA LARGA	CH-150112	BANDA-C/AA	K070901
BANDA-S/AA	K070735	MANGUERA INFERIOR-CABINA CORTA	CH-150102
2009		MANGUERA INFERIOR-CABINA LARGA	CH-150112
MANGUERA SUPERIOR-	CH-150101	MANGUERA INFERIOR-CARROCERÍA CORTA	CH-150102
BANDA-C/AA	K070901	MANGUERA INFERIOR-CARROCERÍA LARGA	CH-150112
MANGUERA INFERIOR-CARROCERÍA CORTA	CH-150102	BANDA-S/AA	K070735
MANGUERA INFERIOR-CARROCERÍA LARGA	CH-150112		
BANDA-S/AA	K070735		
2008			
MANGUERA SUPERIOR-	CH-150101		
MANGUERA SUPERIOR-	CH-150101		
BDH-	BDH-5587		
BANDA-C/AA	K070901		
MANGUERA INFERIOR-CABINA CORTA	CH-150102		
MANGUERA INFERIOR-CABINA LARGA	CH-150112		
MANGUERA INFERIOR-CARROCERÍA CORTA	CH-150102		
MANGUERA INFERIOR-CARROCERÍA LARGA	CH-150112		
BANDA-S/AA	K070735		

VOLKSWAGEN



UTILITARIOS

CRAFTER

5 CIL, 2.5 L TDI

2013			
TERMOSTATO-			TH13287G1
BANDA-ÁRBOL DE LEVAS (141D X 25MM)			T321
BANDA-C/AA			K061020
BANDA-S/AA			K060790
2012			
TERMOSTATO-			TH13287G1
BANDA-ÁRBOL DE LEVAS (141D X 25MM)			T321



MASTER SERVICIO PESADO 2014

VOLKSWAGEN

CRAFTER

BANDA-C/AA	K061020	SENSOR-	T38427
BANDA-S/AA	K060790	BANDA-ÁRBOL DE LEVAS (160D X 25MM)	T1653
2011		BANDA-C/AA	K060635
TERMOSTATO-	TH13287G1	BANDA-S/AA	K060425
BANDA-ÁRBOL DE LEVAS (141D X 25MM)	T321	BANDA STRETCH FIT-VENT	4PK711SF
BANDA-C/AA	K061020	EUROVAN	
BANDA-S/AA	K060790	6 CIL, 2.8 L	
2010		2004	
TERMOSTATO-	TH13287G1	BANDA-ÁRBOL DE LEVAS	CADENA
BANDA-ÁRBOL DE LEVAS (141D X 25MM)	T321	BANDA-SERPENTIN	DK070551
BANDA-C/AA	K061020	5 CIL, 2.5 L	
BANDA-S/AA	K060790	2006	
2009		BANDA-C/AA	K060870
TERMOSTATO-	TH13287G1	MANGUERA SUPERIOR-CORTA	CH-220762
BANDA-ÁRBOL DE LEVAS (141D X 25MM)	T321	MANGUERA SUPERIOR-LARGA	CH-220772
BANDA-C/AA	K061020	BANDA-S/AA	K060532
BANDA-S/AA	K060790	2005	
2008		MANGUERA SUPERIOR-	CH-220762
TERMOSTATO-	TH13287G1	MANGUERA SUPERIOR-	CH-220772
BANDA-ÁRBOL DE LEVAS (141D X 25MM)	T321	SENSOR-ÁRBOL DE LEVAS	TPG-22001
BANDA-C/AA	K061020	BANDA-SERPENTIN	K060532
BANDA-S/AA	K060790	BANDA-SERPENTIN	K060870
5 CIL, 2.0 L TDI		2004	
2014		SENSOR-ÁRBOL DE LEVAS	TPG-22001
POLEA-	T36248	BANDA-C/AA	K060870
TENSOR-	T38427	BANDA-S/AA	K060530
BANDA-ÁRBOL DE LEVAS (160D X 25MM)	T1653	2003	
BANDA-C/AA	K060635	TAPÓN DE ACEITE-	31100
BANDA-S/AA	K060425	TENSOR-ÁRBOL DE LEVAS	TPG-22001
BANDA STRETCH FIT-VENT	4PK711SF	BANDA-ÁRBOL DE LEVAS (122 D x 26.5 MM)	T739
2013		BANDA-C/AA	K060870
POLEA-	T36248	MANGUERA INFERIOR-C/CONEXION A T° 1 DE 2 MANG	CH-220762
		TAPÓN DE GASOLINA-CON LLAVE	31781



MASTER SERVICIO PESADO 2014

VOLKSWAGEN

EUROVAN

MANGUERA SUPERIOR-CORTA 1 DE 2 MANG.	CH-220741	2010	
MANGUERA SUPERIOR-CORTA 1 DE 2 MANG.	CH-220751	MANGUERA INFERIOR-	CH-220112
BANDA-S/AA	K060532	MANGUERA SUPERIOR-	CH-220111
BANDA-S/AA	K060840	KIT DE DISTRIBUCIÓN-	TCK333M
TAPÓN DE GASOLINA-SIN LLAVE	31833	TENSOR-ÁRBOL DE LEVAS	T41229
2002		TENSOR-ÁRBOL DE LEVAS	T43091
MANGUERA INFERIOR-	CH-220762	BANDA DISTRIBUCIÓN-ÁRBOL DE LEVAS (120 D x 30MM)	T333
MANGUERA INFERIOR-	CH-220772	BANDA-C/AA	6DPK1200
MANGUERA SUPERIOR-	CH-220741	BANDA-S/AA	K060441
MANGUERA SUPERIOR-	CH-220751	2009	
TAPÓN DE ACEITE-	31100	KIT DE DISTRIBUCIÓN-	TCK333M
TENSOR-ÁRBOL DE LEVAS	TPG-22001	MANGUERA INFERIOR-	CH-220112
BANDA-ÁRBOL DE LEVAS (122 D x 26.5 MM)	T739	MANGUERA SUPERIOR-	CH-220111
BANDA-C/AA	K060870	TENSOR-ÁRBOL DE LEVAS	T41229
TAPÓN DE GASOLINA-CON LLAVE	31781	TENSOR-ÁRBOL DE LEVAS	T43091
BANDA-S/AA	K060532	BANDA DISTRIBUCIÓN-ÁRBOL DE LEVAS (120 D x 30MM)	T333
BANDA-S/AA	K060840	BANDA-C/AA	6DPK1200
TAPÓN DE GASOLINA-SIN LLAVE	31833	BANDA-S/AA	K060441
2001		2008	
MANGUERA INFERIOR-	CH-220762	KIT DE DISTRIBUCIÓN-	TCK333M
MANGUERA INFERIOR-	CH-220772	MANGUERA INFERIOR-	CH-220112
MANGUERA SUPERIOR-	CH-220741	MANGUERA SUPERIOR-	CH-220111
MANGUERA SUPERIOR-	CH-220751	TENSOR-ÁRBOL DE LEVAS	T41229
TAPÓN DE ACEITE-	31100	TENSOR-ÁRBOL DE LEVAS	T43091
TENSOR-ÁRBOL DE LEVAS	TPG-22001	TENSOR-ÁRBOL DE LEVAS	T41229
BANDA-ÁRBOL DE LEVAS (122 D x 26.5 MM)	T739	TENSOR-ÁRBOL DE LEVAS	T43091
BANDA-C/AA	K060870	BANDA DISTRIBUCIÓN-ÁRBOL DE LEVAS (120 D x 30MM)	T333
TAPÓN DE GASOLINA-CON LLAVE	31781	BANDA DISTRIBUCIÓN-ÁRBOL DE LEVAS (120 D x 30MM)	T333
BANDA-S/AA	K060532	BANDA-MOTOR	6DPK1200
BANDA-S/AA	K060840	BANDA-MOTOR	K060441
TAPÓN DE GASOLINA-SIN LLAVE	31833	2007	
4 CIL. 1.9 L DIESEL		KIT DE DISTRIBUCIÓN-	TCK333M



MASTER SERVICIO PESADO 2014

VOLKSWAGEN

EUROVAN

		PANEL	
MANGUERA INFERIOR-	CH-220112		
MANGUERA SUPERIOR-	CH-220111	4 CIL, 1.8 L	
TENSOR-ÁRBOL DE LEVAS	T41229	2001	
TENSOR-ÁRBOL DE LEVAS	T43091	MANGUERA DE PASO-	CH-220593
TENSOR-ÁRBOL DE LEVAS	T41229	MANGUERA INFERIOR-	CH-227182
TENSOR-ÁRBOL DE LEVAS	T43091	MANGUERA SUPERIOR-	CH-227181
BANDA DISTRIBUCIÓN-ÁRBOL DE LEVAS (120 D x 30MM)	T333	TAPÓN DE ACEITE-	31100
BANDA DISTRIBUCIÓN-ÁRBOL DE LEVAS (120 D x 30MM)	T333	BANDA-ALT	K060365
BANDA-MOTOR	6DPK1200	BANDA-ÁRBOL DE LEVAS (121 D x 18 MM)	T260
BANDA-MOTOR	K060441	TENSOR-C/AA, C/DH	TMV-22001
		TENSOR-S/AA, C/DH	TMV-22002
2006		2000	
KIT DE DISTRIBUCIÓN-	TCK333M	MANGUERA DE PASO-	CH-220593
MANGUERA INFERIOR-	CH-220112	MANGUERA INFERIOR-	CH-227182
MANGUERA SUPERIOR-	CH-220762	MANGUERA SUPERIOR-	CH-227181
MANGUERA SUPERIOR-	CH-220772	TAPÓN DE ACEITE-	31100
MANGUERA SUPERIOR-	CH-220111	BANDA-ALT	K060365
TENSOR-ÁRBOL DE LEVAS	T41229	BANDA-ÁRBOL DE LEVAS (121 D x 18 MM)	T260
TENSOR-ÁRBOL DE LEVAS	T43091	TENSOR-C/AA, C/DH	TMV-22001
BANDA DISTRIBUCIÓN-ÁRBOL DE LEVAS (120 D x 30MM)	T333	TENSOR-S/AA, C/DH	TMV-22002
BANDA-MOTOR	6DPK1200	1999	
BANDA-MOTOR	K060441	MANGUERA DE PASO-	CH-220593
2005		MANGUERA INFERIOR-	CH-227182
MANGUERA INFERIOR-	CH-220112	MANGUERA SUPERIOR-	CH-227181
MANGUERA SUPERIOR-	CH-220111	TAPÓN DE ACEITE-	31100
KIT DE DISTRIBUCIÓN-	TCK333M	BANDA-ALT	K060365
TENSOR-ÁRBOL DE LEVAS	T43091	BANDA-ÁRBOL DE LEVAS (121 D x 18 MM)	T260
TENSOR-ÁRBOL DE LEVAS	T41229	TENSOR-C/AA, C/DH	TMV-22001
BANDA-ÁRBOL DE LEVAS (120 D x 30MM)	T333	TENSOR-S/AA, C/DH	TMV-22002
BANDA-MOTOR	6DPK1200	1998	
BANDA-MOTOR	K060441	MANGUERA DE PASO-	CH-220593
BANDA-MOTOR	K060441	MANGUERA INFERIOR-	CH-227182
BANDA-MOTOR	6DPK1200		



MASTER SERVICIO PESADO 2014

VOLKSWAGEN

PANEL

MANGUERA SUPERIOR-	CH-227181	BANDA-ALT	6370 GS
TAPÓN DE ACEITE-	31100	BANDA-ÁRBOL DE LEVAS {121 D x 18 MM}	T260
BANDA-ALT	K060365	1993	
BANDA-ÁRBOL DE LEVAS {121 D x 18 MM}	T260	MANGUERA DE PASO-	CH-220593
TENSOR-C/AA, C/DH	TMV-22001	MANGUERA INFERIOR-	CH-227182
TENSOR-S/AA, C/DH	TMV-22002	MANGUERA SUPERIOR-	CH-227181
1997		TAPÓN DE ACEITE-	31100
MANGUERA DE PASO-	CH-220593	BANDA-ALT	6370 GS
MANGUERA INFERIOR-	CH-227182	BANDA-ÁRBOL DE LEVAS {121 D x 18 MM}	T260
MANGUERA SUPERIOR-	CH-227181	SAVEIRO	
TAPÓN DE ACEITE-	31100	4 CIL. 1.6 L	
BANDA-ALT	K060365	2013	
BANDA-ÁRBOL DE LEVAS {121 D x 18 MM}	T260	BANDA STRETCH FIT-AA	3PK0796SF
1996		BANDA STRETCH FIT-ALT.	6PK0725SF
MANGUERA DE PASO-	CH-220593	KIT-ÁRBOL DE LEVAS	TCK1548
MANGUERA INFERIOR-	CH-227182	TENSOR-ÁRBOL DE LEVAS	TPG-23001
MANGUERA SUPERIOR-	CH-227181	BANDA-ÁRBOL DE LEVAS (135D X 19MM)	T1548
TAPÓN DE ACEITE-	31100	BANDA STRETCH FIT-C/AA, C/DH	6PK1200SF
BANDA-ALT	K060365	BANDA STRETCH FIT-C/AA, S/DH	6PK0762SF
BANDA-ÁRBOL DE LEVAS {121 D x 18 MM}	T260	2012	
1995		BANDA STRETCH FIT-AA	3PK0796SF
MANGUERA DE PASO-	CH-220593	BANDA STRETCH FIT-ALT.	6PK0725SF
MANGUERA INFERIOR-	CH-227182	KIT-ÁRBOL DE LEVAS	TCK1548
MANGUERA SUPERIOR-	CH-227181	TENSOR-ÁRBOL DE LEVAS	TPG-23001
TAPÓN DE ACEITE-	31100	BANDA-ÁRBOL DE LEVAS (135D X 19MM)	T1548
BANDA-ALT	6370 GS	BANDA STRETCH FIT-C/AA, C/DH	6PK1200SF
BANDA-ÁRBOL DE LEVAS {121 D x 18 MM}	T260	BANDA STRETCH FIT-C/AA, S/DH	6PK0762SF
1994		2011	
MANGUERA DE PASO-	CH-220593	BANDA STRETCH FIT-AA	3PK0796SF
MANGUERA INFERIOR-	CH-227182	BANDA STRETCH FIT-ALT.	6PK0725SF
MANGUERA SUPERIOR-	CH-227181	KIT-ÁRBOL DE LEVAS	TCK1548
TAPÓN DE ACEITE-	31100	TENSOR-ÁRBOL DE LEVAS	TPG-23001



MASTER SERVICIO PESADO 2014

VOLKSWAGEN

SAVEIRO

BANDA-ÁRBOL DE LEVAS (135D X 19MM)	T1548	TENSOR-ÁRBOL DE LEVAS	38427
BANDA STRETCH FIT-C/AA, C/DH	6PK1200SF	BANDA-ÁRBOL DE LEVAS (160D X 25MM)	5649XS
BANDA STRETCH FIT-C/AA, S/DH	6PK0762SF	BANDA-C/AA	K060612
2010		POLEA-MOTOR	T36248
BANDA STRETCH FIT-AA	3PK0796SF	BANDA-S/AA	K060425
BANDA STRETCH FIT-ALT.	6PK0725SF	2010	
KIT-ÁRBOL DE LEVAS	TCK1548	TENSOR-ÁRBOL DE LEVAS	38427
TENSOR-ÁRBOL DE LEVAS	TPG-23001	BANDA-ÁRBOL DE LEVAS (160D X 25MM)	5649XS
BANDA-ÁRBOL DE LEVAS (135D X 19MM)	T1548	BANDA-MOTOR	K060425
BANDA STRETCH FIT-C/AA, C/DH	6PK1200SF	BANDA-MOTOR	K060612
BANDA STRETCH FIT-C/AA, S/DH	6PK0762SF	POLEA-MOTOR	T36248

TRANSPORTER

4 CIL. 2.0 L TDI

2014

TENSOR-ÁRBOL DE LEVAS	38427
BANDA-ÁRBOL DE LEVAS (160D X 25MM)	5649XS
BANDA-C/AA	K060612
POLEA-MOTOR	T36248
BANDA-S/AA	K060425

2013

TENSOR-ÁRBOL DE LEVAS	38427
BANDA-ÁRBOL DE LEVAS (160D X 25MM)	5649XS
BANDA-C/AA	K060612
POLEA-MOTOR	T36248
BANDA-S/AA	K060425

2012

TENSOR-ÁRBOL DE LEVAS	38427
BANDA-ÁRBOL DE LEVAS (160D X 25MM)	5649XS
BANDA-C/AA	K060612
POLEA-MOTOR	T36248
BANDA-S/AA	K060425

2011

VW VAN

4 CIL, 1.8 L

2006

BANDA-ÁRBOL DE LEVAS (121 D x 18 MM)	T260
BANDA-C/AA	K060455
BANDA-C/AA, C/DH	7295
BANDA-S/AA	K060385
BANDA-S/AA, C/DH	7270

2005

BANDA-ÁRBOL DE LEVAS (121 D x 18 MM)	T260
BANDA-MOTOR	7295
BANDA-S/AA	7270
BANDA-SERPENTIN	K060385
BANDA-SERPENTIN	K060455

4 CIL, 1.6 L

2006

TENSOR-MOTOR	TMV-23001
--------------	-----------

2005

TENSOR-ÁRBOL DE LEVAS	TPG-23001
TENSOR-MOTOR	TMV-23001

2004

TENSOR-ÁRBOL DE LEVAS	TPG-23001
-----------------------	-----------

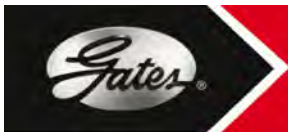

MASTER SERVICIO PESADO 2014

VOLKSWAGEN

VW VAN

BANDA-C/AA	K060455
BANDA-DH	7270
BANDA-MOTOR	7295
TENSOR-MOTOR	TMV-23001
BANDA-S/AA	K060385
2003	
TENSOR-ÁRBOL DE LEVAS	TPG-23001
TENSOR-MOTOR	TMV-23001
BANDA-S/AA	K060385



MASTER SERVICIO PESADO 2014

BANDAS

MARCA	MODELO	MOTOR	AÑOS	MARCA	MODELO	MOTOR	AÑOS
2/9100PK				INTERNATIONAL/NAVISTAR	5000	CUMMINS N14 DIESEL	1992-1998
MERCEDES BENZ	0371 RS	OM 355	1990-1998	INTERNATIONAL/NAVISTAR	9100	CUMMINS N14 DIESEL	1998-1999
MERCEDES BENZ	AUTOBUS INTEGRAL	OM 355 LA	1991-1991	INTERNATIONAL/NAVISTAR	9100I	CUMMINS N14 DIESEL	2000-2003
2/9104PK				INTERNATIONAL/NAVISTAR	9200	CUMMINS N14 DIESEL	1996-1999
MERCEDES BENZ	0371 RS	OM 447	1990-1998	INTERNATIONAL/NAVISTAR	9200I	CUMMINS N14 DIESEL	2000-2002
MERCEDES BENZ	AUTOBUS INTEGRAL	OM 447 LA	1992-1998	INTERNATIONAL/NAVISTAR	9300	CUMMINS N14 DIESEL	1995-1999
MERCEDES BENZ	AUTOBUS INTEGRAL	OM 449 LA	1993-1996	INTERNATIONAL/NAVISTAR	9400	CUMMINS N14 DIESEL	1995-1999
2/9313PB				INTERNATIONAL/NAVISTAR	9400I	CUMMINS N14 DIESEL	2000-2002
INTERNATIONAL/NAVISTAR	8200	DETROIT DIESEL 6 CIL, 11.1 L DIESEL	1995-1995	INTERNATIONAL/NAVISTAR	9900	CUMMINS N14 DIESEL	1999-1999
INTERNATIONAL/NAVISTAR	8200	DETROIT DIESEL 6 CIL, 12.7 L DIESEL	1995-1995	INTERNATIONAL/NAVISTAR	9900I	CUMMINS N14 DIESEL	2000-2002
INTERNATIONAL/NAVISTAR	9100	DETROIT DIESEL SERIE 60	1998-1998	INTERNATIONAL/NAVISTAR	9900IX	CUMMINS N14 DIESEL	2000-2002
INTERNATIONAL/NAVISTAR	9200	DETROIT DIESEL SERIE 60	1998-1998	INTERNATIONAL/NAVISTAR	PAYSTAR	CUMMINS N14 DIESEL	1992-1998
INTERNATIONAL/NAVISTAR	9300	DETROIT DIESEL 6 CIL, 11.1 L DIESEL	1995-1997	VOLVO	WG SERIES	CATERPILLAR 3306 DIESEL	1996-1996
INTERNATIONAL/NAVISTAR	9300	DETROIT DIESEL 6 CIL, 12.7 L DIESEL	1995-1997	VOLVO	XPEDITOR	CATERPILLAR 3306 DIESEL	1996-1996
INTERNATIONAL/NAVISTAR	9300	DETROIT DIESEL SERIE 60	1998-1998	2/9451 PB			
INTERNATIONAL/NAVISTAR	9400	DETROIT DIESEL 6 CIL, 11.1 L DIESEL	1996-1996	MERCEDES BENZ	BUSSCAR	DDA 560	1997-2001
INTERNATIONAL/NAVISTAR	9400	DETROIT DIESEL 6 CIL, 11.1 L DIESEL	1995-1995	2/9451PB			
INTERNATIONAL/NAVISTAR	9400	DETROIT DIESEL 6 CIL, 12.7 L DIESEL	1996-1996	FREIGHTLINER	CENTURY CLASS	CUMMINS N14 DIESEL	1996-1998
INTERNATIONAL/NAVISTAR	9400	DETROIT DIESEL 6 CIL, 12.7 L DIESEL	1995-1995	FREIGHTLINER	FLC	CUMMINS N14 DIESEL	1997-1998
INTERNATIONAL/NAVISTAR	9400	DETROIT DIESEL SERIE 60	1992-1998	FREIGHTLINER	FLC	CUMMINS N14 DIESEL	1992-1996
INTERNATIONAL/NAVISTAR	9600	DETROIT DIESEL 6 CIL, 11.1 L DIESEL	1996-1996	FREIGHTLINER	FLC	CUMMINS N14 DIESEL	1991-1996
INTERNATIONAL/NAVISTAR	9600	DETROIT DIESEL 6 CIL, 12.7 L DIESEL	1995-1995	FREIGHTLINER	FLD	CUMMINS N14 DIESEL	1992-1996
INTERNATIONAL/NAVISTAR	9700	DETROIT DIESEL 6 CIL, 11.1 L DIESEL	1996-1996	FREIGHTLINER	FLD	CUMMINS N14 DIESEL	1991-1996
INTERNATIONAL/NAVISTAR	9700	DETROIT DIESEL 6 CIL, 12.7 L DIESEL	1996-1996	VOLVO	WG SERIES	CATERPILLAR 3306 DIESEL	1996-1996
INTERNATIONAL/NAVISTAR	9800	DETROIT DIESEL SERIE 60	1997-1997	VOLVO	WG SERIES	CUMMINS N14 DIESEL	1996-1997
2/9325PB				2/9463PB			
KENWORTH	K100	DETROIT DIESEL 6 CIL, 11.1 L DIESEL	1996-1996	FREIGHTLINER	FLC	CUMMINS N14 DIESEL	1991-1996
KENWORTH	K100	DETROIT DIESEL 6 CIL, 12.7 L DIESEL	1994-1996	FREIGHTLINER	FLD	CUMMINS N14 DIESEL	1991-1996
KENWORTH	K100	DETROIT DIESEL SERIE 60	1996-1996	INTERNATIONAL/NAVISTAR	8100	CUMMINS N14 DIESEL	1998-1999
KENWORTH	W900	DETROIT DIESEL 6 CIL, 11.1 L DIESEL	1996-1996	INTERNATIONAL/NAVISTAR	9100	CATERPILLAR C10 DIESEL	1998-1999
KENWORTH	W900	DETROIT DIESEL 6 CIL, 12.7 L DIESEL	1996-1996	INTERNATIONAL/NAVISTAR	9100I	CATERPILLAR C10 DIESEL	2000-2003
KENWORTH	W900	DETROIT DIESEL SERIE 60	1996-1996	INTERNATIONAL/NAVISTAR	9100I	CATERPILLAR C12 DIESEL	2000-2003
2/9430PB				INTERNATIONAL/NAVISTAR	9100I	CATERPILLAR C12 DIESEL	2000-2003
MERCEDES BENZ	MARCOPOLO	MB 457 ELECTRONICO	1997-2003	INTERNATIONAL/NAVISTAR	9200	CATERPILLAR C10 DIESEL	1996-1999
INTERNATIONAL/NAVISTAR	9200	CUMMINS N14 DIESEL	1996-1996	INTERNATIONAL/NAVISTAR	9200	CATERPILLAR C12 DIESEL	1996-1999
INTERNATIONAL/NAVISTAR	9300	CUMMINS N14 DIESEL	1995-1995	INTERNATIONAL/NAVISTAR	9200I	CUMMINS N14 DIESEL	1996-1997
INTERNATIONAL/NAVISTAR	9400	CUMMINS N14 DIESEL	1995-1995	INTERNATIONAL/NAVISTAR	9200I	CATERPILLAR C10 DIESEL	2000-2003
2/9435PB				INTERNATIONAL/NAVISTAR	9200I	CATERPILLAR C12 DIESEL	2000-2003
FREIGHTLINER	CENTURY CLASS	CUMMINS N14 DIESEL	1996-1998	INTERNATIONAL/NAVISTAR	9300	CATERPILLAR C10 DIESEL	1996-1998
FREIGHTLINER	CENTURY CLASS	CUMMINS N14 DIESEL	1996-1998	INTERNATIONAL/NAVISTAR	9300	CUMMINS N14 DIESEL	1995-1997
FREIGHTLINER	FLC	CUMMINS N14 DIESEL	1997-1998	INTERNATIONAL/NAVISTAR	9400	CATERPILLAR C10 DIESEL	1996-1999
FREIGHTLINER	FLC	CUMMINS N14 DIESEL	1997-1997	INTERNATIONAL/NAVISTAR	9400	CATERPILLAR C12 DIESEL	1996-1999
FREIGHTLINER	FLD	CUMMINS N14 DIESEL	1997-1998	INTERNATIONAL/NAVISTAR	9400	CUMMINS N14 DIESEL	1995-1997
2/9447PB				INTERNATIONAL/NAVISTAR	9400I	CATERPILLAR C10 DIESEL	2000-2002



MASTER SERVICIO PESADO 2014

BANDAS

MARCA	MODELO	MOTOR	AÑOS	MARCA	MODELO	MOTOR	AÑOS
INTERNATIONAL/NAVISTAR	9400I	CATERPILLAR C12 DIESEL	2000-2003	KENWORTH	C500	DETROIT DIESEL 6 CIL, 12.7 L DIESEL	1994-1994
INTERNATIONAL/NAVISTAR	9900	CATERPILLAR C10 DIESEL	1999-1999	KENWORTH	T600	DETROIT DIESEL 6 CIL, 11.1 L DIESEL	1994-1994
INTERNATIONAL/NAVISTAR	9900	CATERPILLAR C12 DIESEL	1999-1999	KENWORTH	T600	DETROIT DIESEL 6 CIL, 12.7 L DIESEL	1994-1994
INTERNATIONAL/NAVISTAR	9900I	CATERPILLAR C10 DIESEL	2000-2002	KENWORTH	T600	DETROIT DIESEL SERIE 60	1990-1994
INTERNATIONAL/NAVISTAR	9900I	CATERPILLAR C12 DIESEL	2000-2003	KENWORTH	T600	DETROIT DIESEL SERIE 60	1990-1994
INTERNATIONAL/NAVISTAR	9900IX	CATERPILLAR C10 DIESEL	2000-2002	KENWORTH	T800	DETROIT DIESEL 6 CIL, 11.1 L DIESEL	1994-1994
INTERNATIONAL/NAVISTAR	9900IX	CATERPILLAR C12 DIESEL	2000-2003	KENWORTH	T800	DETROIT DIESEL 6 CIL, 12.7 L DIESEL	1994-1994
KENWORTH	T600	CATERPILLAR 3406 DIESEL	1990-1996	KENWORTH	T800	DETROIT DIESEL SERIE 60	1990-1994
KENWORTH	T600	CUMMINS N14 DIESEL	1995-1996	KENWORTH	T800	DETROIT DIESEL SERIE 60	1990-1994
KENWORTH	T800	CATERPILLAR 3406 DIESEL	1990-1996	KENWORTH	W900	DETROIT DIESEL 6 CIL, 11.1 L DIESEL	1991-1993
KENWORTH	T800	CUMMINS N14 DIESEL	1995-1996	KENWORTH	W900	DETROIT DIESEL 6 CIL, 12.7 L DIESEL	1991-1993
KENWORTH	W900	CUMMINS N14 DIESEL	1995-1996	KENWORTH	W900	DETROIT DIESEL SERIE 60	1990-1993
VOLVO	WG SERIES	CATERPILLAR 3306 DIESEL	1996-1997	MASA	ESTRADA	DETROIT DIESEL SERIE 50	1997-2000
VOLVO	WG SERIES	CUMMINS N14 DIESEL	1996-1997	VOLVO	FE SERIES	VOLVO VE D7 DIESEL	1995-1995
VOLVO	WIA SERIES	CUMMINS N14 DIESEL	1996-1998	VOLVO	XPEDITOR	CATERPILLAR 3306 DIESEL	1996-1996
2/9470PB				2/9510 PB			
INTERNATIONAL/NAVISTAR	9300	CUMMINS N14 DIESEL	1995-1995	MERCEDES BENZ	BUSSCAR	DDA 560	1997-2001
INTERNATIONAL/NAVISTAR	9400	CUMMINS N14 DIESEL	1995-1995	2/9510PB			
INTERNATIONAL/NAVISTAR	9600	CUMMINS N14 DIESEL	1996-1996	FREIGHTLINER	CENTURY CLASS	DETROIT DIESEL 6 CIL, 11.1 L DIESEL	1997-1998
INTERNATIONAL/NAVISTAR	9700	CUMMINS N14 DIESEL	1996-1996	FREIGHTLINER	CENTURY CLASS	DETROIT DIESEL 6 CIL, 11.1 L DIESEL	1999-1999
KENWORTH	T600	CUMMINS 6 CIL, 14.0 L DIESEL	1991-1991	FREIGHTLINER	CENTURY CLASS	DETROIT DIESEL 6 CIL, 12.7 L DIESEL	1997-1998
KENWORTH	T600	CUMMINS N14 DIESEL	1992-1996	FREIGHTLINER	CENTURY CLASS	DETROIT DIESEL 6 CIL, 12.7 L DIESEL	1999-1999
KENWORTH	T800	CATERPILLAR 3306 DIESEL	1990-1992	FREIGHTLINER	CENTURY CLASS	DETROIT DIESEL SERIE 60	1999-1999
KENWORTH	T800	CUMMINS 6 CIL, 14.0 L DIESEL	1991-1991	FREIGHTLINER	CENTURY CLASS	DETROIT DIESEL SERIE 60	1997-1998
KENWORTH	T800	CUMMINS N14 DIESEL	1992-1996	FREIGHTLINER	CENTURY CLASS	DETROIT DIESEL SERIE 60	1999-1999
KENWORTH	W900	CUMMINS N14 DIESEL	1995-1996	FREIGHTLINER	FLC	CATERPILLAR 3406 DIESEL	1990-1993
2/9476PB				FREIGHTLINER	FLC	DETROIT DIESEL 6 CIL, 11.1 L DIESEL	1997-1998
VOLVO	7350	B7R	2003-2003	FREIGHTLINER	FLC	DETROIT DIESEL 6 CIL, 12.7 L DIESEL	1996-1998
2/9485FPB				FREIGHTLINER	FLC	DETROIT DIESEL SERIE 60	1990-1997
STERLING	A-LINE	DETROIT DIESEL 6 CIL, 11.1 L DIESEL	2000-2000	FREIGHTLINER	FLD	DETROIT DIESEL 6 CIL, 11.1 L DIESEL	1991-1995
STERLING	A-LINE	DETROIT DIESEL 6 CIL, 12.7 L DIESEL	2000-2000	FREIGHTLINER	FLD	DETROIT DIESEL 6 CIL, 11.1 L DIESEL	1991-1995
STERLING	L-LINE	DETROIT DIESEL 6 CIL, 11.1 L DIESEL	2000-2001	FREIGHTLINER	FLD	DETROIT DIESEL 6 CIL, 11.1 L DIESEL	1997-1999
STERLING	L-LINE	DETROIT DIESEL 6 CIL, 12.7 L DIESEL	2000-2001	FREIGHTLINER	FLD	DETROIT DIESEL 6 CIL, 12.7 L DIESEL	1991-1995
2/9490PB				FREIGHTLINER	FLD	DETROIT DIESEL 6 CIL, 12.7 L DIESEL	1991-1995
KENWORTH	W900	DETROIT DIESEL 6 CIL, 11.1 L DIESEL	1991-1993	FREIGHTLINER	FLD	DETROIT DIESEL 6 CIL, 12.7 L DIESEL	1997-1999
KENWORTH	W900	DETROIT DIESEL 6 CIL, 12.7 L DIESEL	1991-1993	FREIGHTLINER	FLD	DETROIT DIESEL SERIE 60	1990-1995
KENWORTH	W900	DETROIT DIESEL SERIE 60	1990-1993	FREIGHTLINER	FLD	DETROIT DIESEL SERIE 60	1990-1995
VOLVO	WIA SERIES	DETROIT DIESEL 6 CIL, 11.1 L DIESEL	1996-1998	FREIGHTLINER	FLD	DETROIT DIESEL SERIE 60	1997-1999
VOLVO	WIA SERIES	DETROIT DIESEL 6 CIL, 12.7 L DIESEL	1996-1998	KENWORTH	C500	DETROIT DIESEL 6 CIL, 11.1 L DIESEL	1991-1994
2/9500PB				KENWORTH	C500	DETROIT DIESEL 6 CIL, 12.7 L DIESEL	1991-1994
FREIGHTLINER	FLC	DETROIT DIESEL SERIE 60	1990-1990	KENWORTH	T600	DETROIT DIESEL 6 CIL, 11.1 L DIESEL	1991-1994
FREIGHTLINER	FLD	DETROIT DIESEL 6 CIL, 11.1 L DIESEL	1991-1995	KENWORTH	T600	DETROIT DIESEL 6 CIL, 12.7 L DIESEL	1991-1994
FREIGHTLINER	FLD	DETROIT DIESEL 6 CIL, 12.7 L DIESEL	1991-1995	KENWORTH	T600	DETROIT DIESEL SERIE 60	1990-1994
FREIGHTLINER	FLD	DETROIT DIESEL SERIE 60	1990-1995	KENWORTH	T800	DETROIT DIESEL 6 CIL, 11.1 L DIESEL	1991-1994
KENWORTH	C500	DETROIT DIESEL 6 CIL, 11.1 L DIESEL	1994-1994	KENWORTH	T800	DETROIT DIESEL 6 CIL, 12.7 L DIESEL	1991-1994



MASTER SERVICIO PESADO 2014

BANDAS

MARCA	MODELO	MOTOR	AÑOS
KENWORTH	T800	DETROIT DIESEL SERIE 60	1990-1994
KENWORTH	W900	DETROIT DIESEL 6 CIL, 11.1 L DIESEL	1991-1993
KENWORTH	W900	DETROIT DIESEL 6 CIL, 12.7 L DIESEL	1991-1993
KENWORTH	W900	DETROIT DIESEL SERIE 60	1990-1993
VOLVO	7350	B7R	2003-2003
2/9520PB			
KENWORTH	C500	DETROIT DIESEL 6 CIL, 11.1 L DIESEL	1991-1994
KENWORTH	C500	DETROIT DIESEL 6 CIL, 12.7 L DIESEL	1991-1994
KENWORTH	K100	DETROIT DIESEL 6 CIL, 11.1 L DIESEL	1991-1993
KENWORTH	K100	DETROIT DIESEL 6 CIL, 12.7 L DIESEL	1991-1993
KENWORTH	K100	DETROIT DIESEL SERIE 60	1991-1993
KENWORTH	T600	CATERPILLAR 3406 DIESEL	1990-1995
KENWORTH	T600	DETROIT DIESEL 6 CIL, 11.1 L DIESEL	1991-1999
KENWORTH	T600	DETROIT DIESEL 6 CIL, 12.7 L DIESEL	1991-1999
KENWORTH	T600	DETROIT DIESEL SERIE 60	1990-1999
KENWORTH	T800	CATERPILLAR 3406 DIESEL	1990-1995
KENWORTH	T800	DETROIT DIESEL 6 CIL, 11.1 L DIESEL	1991-1999
KENWORTH	T800	DETROIT DIESEL 6 CIL, 12.7 L DIESEL	1991-1999
KENWORTH	T800	DETROIT DIESEL SERIE 60	1990-1999
KENWORTH	W900	DETROIT DIESEL 6 CIL, 11.1 L DIESEL	1994-1999
KENWORTH	W900	DETROIT DIESEL 6 CIL, 12.7 L DIESEL	1994-1999
KENWORTH	W900	DETROIT DIESEL SERIE 60	1997-1999
2/9530PB			
FREIGHTLINER	FLD	CATERPILLAR 3306 DIESEL	1993-1994
FREIGHTLINER	FLD	CATERPILLAR 3306 DIESEL	1991-1992
KENWORTH	C500	CATERPILLAR 3306 DIESEL	1991-1992
KENWORTH	W900	CATERPILLAR 3406 DIESEL	1990-1995
2/9540PB			
KENWORTH	K100	CATERPILLAR 3406 DIESEL	1991-1993
2/9545 PB			
MERCEDES BENZ	CENTURY CLASS	CENTURY CLASS	2006-2010
MERCEDES BENZ	MARCOPOLO ANDARE	O-500-1728	2005-2006
MERCEDES BENZ	MARCOPOLO ANDARE	O-500-1735	2007-2010
2/9545PB			
FREIGHTLINER	FLC	DETROIT DIESEL SERIE 60	1990-1990
FREIGHTLINER	FLD	DETROIT DIESEL 6 CIL, 11.1 L DIESEL	1991-1995
FREIGHTLINER	FLD	DETROIT DIESEL 6 CIL, 11.1 L DIESEL	1996-1996
FREIGHTLINER	FLD	DETROIT DIESEL 6 CIL, 12.7 L DIESEL	1991-1995
FREIGHTLINER	FLD	DETROIT DIESEL 6 CIL, 12.7 L DIESEL	1996-1996
FREIGHTLINER	FLD	DETROIT DIESEL SERIE 60	1990-1995
FREIGHTLINER	FLD	DETROIT DIESEL SERIE 60	1996-1996
2/9550PB			
FREIGHTLINER	FLC	CATERPILLAR 3406 DIESEL	1990-1993
FREIGHTLINER	FLD	CATERPILLAR 3306 DIESEL	1991-1992
FREIGHTLINER	FLD	CATERPILLAR 3406 DIESEL	1990-1997

MARCA	MODELO	MOTOR	AÑOS
2/9555PB			
FREIGHTLINER	FLC	DETROIT DIESEL SERIE 60	1990-1990
FREIGHTLINER	FLD	DETROIT DIESEL 6 CIL, 11.1 L DIESEL	1991-1995
FREIGHTLINER	FLD	DETROIT DIESEL 6 CIL, 12.7 L DIESEL	1991-1995
FREIGHTLINER	FLD	DETROIT DIESEL SERIE 60	1990-1995
KENWORTH	W900	CATERPILLAR 3406 DIESEL	1990-1990
KENWORTH	W900	CATERPILLAR 3406 DIESEL	1991-1995
KENWORTH	W900	CATERPILLAR 3406 DIESEL	1990-1996
2/9570 PB			
MERCEDES BENZ	MARCOPOLO	MB 457 ELECTRONICO	1997-2003
2/9570PB			
FREIGHTLINER	FLC	CATERPILLAR 3406 DIESEL	1990-1993
KENWORTH	K100	CATERPILLAR 3406 DIESEL	1990-1991
KENWORTH	T400	CATERPILLAR 3306 DIESEL	1990-1992
KENWORTH	T450	CATERPILLAR 3306 DIESEL	1990-1996
2/9590PB			
FREIGHTLINER	FLD	DETROIT DIESEL 6 CIL, 11.1 L DIESEL	1991-1995
FREIGHTLINER	FLD	DETROIT DIESEL 6 CIL, 12.7 L DIESEL	1991-1995
FREIGHTLINER	FLD	DETROIT DIESEL SERIE 60	1990-1995
KENWORTH	W900	CATERPILLAR 3406 DIESEL	1990-1999
2/9610PB			
KENWORTH	T600	CATERPILLAR 3406 DIESEL	1990-1999
KENWORTH	T800	CATERPILLAR 3406 DIESEL	1990-1998
KENWORTH	W900	CATERPILLAR 3406 DIESEL	1990-1996
VOLVO	WG SERIES	CATERPILLAR 3306 DIESEL	1996-1996
2/9640PB			
FREIGHTLINER	FLD	CATERPILLAR 3306 DIESEL	1993-1994
KENWORTH	T2000	CATERPILLAR 3406 DIESEL	1997-1999
2/9650PB			
KENWORTH	W900	CATERPILLAR 3406 DIESEL	1990-1996
2/9660 PB			
MERCEDES BENZ	MARCOPOLO ANDARE	O-500-1728	2005-2006
2/9670 PB			
MERCEDES BENZ	MARCOPOLO	MB 457 ELECTRONICO	1997-2003
2/9690 PB			
MERCEDES BENZ	CENTURY CLASS	CENTURY CLASS	2006-2010
MERCEDES BENZ	MARCOPOLO ANDARE	O-500-1735	2007-2010
2/9730 PB			
MERCEDES BENZ	MARCOPOLO	MB 457 ELECTRONICO	1997-2003
2/A78			
VOLVO	7350	D7C	2002-2002
2/AX34			
VOLVO	7350	D7C	2002-2002
2/AX41			
VOLVO	7350	B7R	2003-2003



MASTER SERVICIO PESADO 2014

BANDAS

MARCA	MODELO	MOTOR	AÑOS	MARCA	MODELO	MOTOR	AÑOS
		2/B83					
MERCEDES BENZ	BUSS 320	BUSS 320	2002-2006	KENWORTH	T800	CUMMINS 6 CIL, 14.0 L DIESEL	1991-1991
MERCEDES BENZ	TURICLASS	O-500-1841	2007-2010	KENWORTH	T800	CUMMINS N14 DIESEL	1992-1996
		2/B88				2/TR28429PB	
MERCEDES BENZ	ALBATROS	MB 447	2000-2006	FREIGHTLINER	FLC	CUMMINS N14 DIESEL	1991-1996
		2/B90		FREIGHTLINER	FLD	CUMMINS N14 DIESEL	1991-1996
MERCEDES BENZ	MARCOPOLO	MB 457 ELECTRONICO	1997-2003	KENWORTH	T600	CUMMINS 6 CIL, 14.0 L DIESEL	1991-1991
		2/B93		KENWORTH	T600	CUMMINS N14 DIESEL	1992-1996
MERCEDES BENZ	BUSSCAR	DDA 560	1997-2001	KENWORTH	T800	CUMMINS 6 CIL, 14.0 L DIESEL	1991-1991
		2/BX76		KENWORTH	T800	CUMMINS N14 DIESEL	1992-1996
VOLVO	7350	B7R	2003-2003			2/TR28437PB	
		2/BX92		FREIGHTLINER	FLC	CUMMINS N14 DIESEL	1991-1996
VOLVO	7350	D7C	2002-2002	FREIGHTLINER	FLD	CUMMINS N14 DIESEL	1991-1996
		2/BX97		KENWORTH	T600	CATERPILLAR 3406 DIESEL	1990-1996
VOLVO	7350	B7R	2003-2003	KENWORTH	T600	CUMMINS 6 CIL, 14.0 L DIESEL	1991-1991
		2/TR22517PB		KENWORTH	T600	CUMMINS N14 DIESEL	1992-1996
FREIGHTLINER	FLD	CATERPILLAR 3406 DIESEL	1991-1997	KENWORTH	T800	CATERPILLAR 3406 DIESEL	1990-1996
		2/TR22553PB		KENWORTH	T800	CUMMINS 6 CIL, 14.0 L DIESEL	1991-1991
INTERNATIONAL/NAVISTAR	9300	CATERPILLAR 3406 DIESEL	1995-1995	KENWORTH	T800	CUMMINS N14 DIESEL	1992-1996
INTERNATIONAL/NAVISTAR	9400	CATERPILLAR 3406 DIESEL	1995-1995			2/TR28446PB	
KENWORTH	T600	CATERPILLAR C15 DIESEL	2000-2004	FREIGHTLINER	CLASSIC	CUMMINS N14 DIESEL	2002-2002
		2/TR22570PB		FREIGHTLINER	CLASSIC XL	CUMMINS N14 DIESEL	2002-2003
INTERNATIONAL/NAVISTAR	9300	CATERPILLAR 3406 DIESEL	1995-1995	FREIGHTLINER	FLD	CUMMINS N14 DIESEL	2002-2003
INTERNATIONAL/NAVISTAR	9300	CATERPILLAR 3406 DIESEL	1995-1995			2/TR28473PB	
INTERNATIONAL/NAVISTAR	9400	CATERPILLAR 3406 DIESEL	1995-1995	FREIGHTLINER	FLC	CUMMINS N14 DIESEL	1991-1996
INTERNATIONAL/NAVISTAR	9400	CATERPILLAR 3406 DIESEL	1995-1995	FREIGHTLINER	FLD	CUMMINS N14 DIESEL	1991-1996
KENWORTH	T2000	CATERPILLAR 3406 DIESEL	1997-2000	INTERNATIONAL/NAVISTAR	8100	CUMMINS N14 DIESEL	1997-1999
KENWORTH	T2000	CATERPILLAR C15 DIESEL	2000-2003	INTERNATIONAL/NAVISTAR	8100	CUMMINS N14 DIESEL	1995-1995
KENWORTH	T2000	CATERPILLAR C16 DIESEL	2000-2003	INTERNATIONAL/NAVISTAR	8200	CUMMINS N14 DIESEL	1997-1998
KENWORTH	T600	CATERPILLAR 3406 DIESEL	1991-1996	INTERNATIONAL/NAVISTAR	8200	CUMMINS N14 DIESEL	1995-1995
KENWORTH	T800	CATERPILLAR 3406 DIESEL	1991-1996	INTERNATIONAL/NAVISTAR	9200	CUMMINS N14 DIESEL	1996-1996
KENWORTH	W900	CATERPILLAR 3406 DIESEL	1991-2000			2/TR28480PB	
KENWORTH	W900	CATERPILLAR C10 DIESEL	1997-2000	FREIGHTLINER	FLC	CUMMINS N14 DIESEL	1991-1996
KENWORTH	W900	CATERPILLAR C12 DIESEL	2000-2000	FREIGHTLINER	FLD	CUMMINS N14 DIESEL	1991-1996
KENWORTH	W900	CATERPILLAR C15 DIESEL	2000-2003	INTERNATIONAL/NAVISTAR	8100	CUMMINS N14 DIESEL	1995-1995
KENWORTH	W900	CATERPILLAR C16 DIESEL	2000-2003	INTERNATIONAL/NAVISTAR	8200	CUMMINS N14 DIESEL	1995-1995
		2/TR28400PB		INTERNATIONAL/NAVISTAR	9200	CUMMINS N14 DIESEL	1996-1996
KENWORTH	K100	CUMMINS 6 CIL, 14.0 L DIESEL	1991-1991	INTERNATIONAL/NAVISTAR	9300	CUMMINS N14 DIESEL	1995-1995
KENWORTH	K100	CUMMINS N14 DIESEL	1992-1993	INTERNATIONAL/NAVISTAR	9400	CUMMINS N14 DIESEL	1995-1995
		2/TR28411PB		KENWORTH	W900	CUMMINS N14 DIESEL	1993-1996
FREIGHTLINER	CENTURY CLASS	CUMMINS N14 DIESEL	1996-2001			2/TR28492PB	
FREIGHTLINER	FLC	CUMMINS N14 DIESEL	1997-1998	FREIGHTLINER	FLC	CUMMINS N14 DIESEL	1991-1996
KENWORTH	T2000	CUMMINS N14 DIESEL	1997-2000	FREIGHTLINER	FLD	CUMMINS N14 DIESEL	1991-1996
KENWORTH	T600	CUMMINS 6 CIL, 14.0 L DIESEL	1991-1991	INTERNATIONAL/NAVISTAR	5000	CUMMINS N14 DIESEL	1992-1993
KENWORTH	T600	CUMMINS N14 DIESEL	1992-1996	INTERNATIONAL/NAVISTAR	9200	CUMMINS N14 DIESEL	1996-1996
				INTERNATIONAL/NAVISTAR	9600	CUMMINS N14 DIESEL	1996-1996



MASTER SERVICIO PESADO 2014

BANDAS

MARCA	MODELO	MOTOR	AÑOS	MARCA	MODELO	MOTOR	AÑOS
INTERNATIONAL/NAVISTAR	9700	CUMMINS N14 DIESEL	1996-1996	FREIGHTLINER	CLASSIC	DETROIT DIESEL 6 CIL, 14.0 L DIESEL	2003-2004
INTERNATIONAL/NAVISTAR	9800	CUMMINS N14 DIESEL	1997-1999	FREIGHTLINER	CLASSIC XL	DETROIT DIESEL 6 CIL, 11.1 L DIESEL	2001-2002
INTERNATIONAL/NAVISTAR	PAYSTAR	CUMMINS N14 DIESEL	1992-1993	FREIGHTLINER	CLASSIC XL	DETROIT DIESEL 6 CIL, 12.7 L DIESEL	2001-2004
KENWORTH	K100	CUMMINS 6 CIL, 14.0 L DIESEL	1991-1991	FREIGHTLINER	CLASSIC XL	DETROIT DIESEL 6 CIL, 14.0 L DIESEL	2001-2004
KENWORTH	K100	CUMMINS N14 DIESEL	1992-1993	FREIGHTLINER	FLD	DETROIT DIESEL 6 CIL, 11.1 L DIESEL	2000-2002
KENWORTH	W900	CUMMINS N14 DIESEL	1993-1996	FREIGHTLINER	FLD	DETROIT DIESEL 6 CIL, 12.7 L DIESEL	2000-2004
2/TR28501PB				FREIGHTLINER	FLD	DETROIT DIESEL 6 CIL, 14.0 L DIESEL	2001-2004
FREIGHTLINER	FLC	CUMMINS N14 DIESEL	1991-1996	FREIGHTLINER	FLD	DETROIT DIESEL SERIE 60	2004-2004
FREIGHTLINER	FLD	CUMMINS N14 DIESEL	1991-1996	3/9530PB			
KENWORTH	K100	CUMMINS 6 CIL, 14.0 L DIESEL	1991-1991	FREIGHTLINER	FLD	DETROIT DIESEL 6 CIL, 11.1 L DIESEL	1991-1996
KENWORTH	K100	CUMMINS N14 DIESEL	1992-1993	FREIGHTLINER	FLD	DETROIT DIESEL 6 CIL, 11.1 L DIESEL	1997-1997
2/XPB2000				FREIGHTLINER	FLD	DETROIT DIESEL 6 CIL, 12.7 L DIESEL	1991-1996
MERCEDES BENZ	MULTEGO	MULTEGO	2002-2009	FREIGHTLINER	FLD	DETROIT DIESEL 6 CIL, 12.7 L DIESEL	1997-1997
MERCEDES BENZ	TURICLASS	O-500-1841	2007-2010	33469			
3/9470PB				FORD	TRANSIT	4 CIL, 2.2 L TDI	2008-2010
KENWORTH	C500	DETROIT DIESEL 6 CIL, 11.1 L DIESEL	1991-1994	38609			
KENWORTH	C500	DETROIT DIESEL 6 CIL, 12.7 L DIESEL	1991-1994	KENWORTH	W900	CATERPILLAR C15 DIESEL	2008-2010
KENWORTH	T2000	DETROIT DIESEL 6 CIL, 11.1 L DIESEL	1997-2000	38636			
KENWORTH	T2000	DETROIT DIESEL 6 CIL, 12.7 L DIESEL	1997-2000	KENWORTH	W900	CATERPILLAR C15 DIESEL	2008-2010
KENWORTH	T600	DETROIT DIESEL 6 CIL, 11.1 L DIESEL	1991-1994	3PK0796SF			
KENWORTH	T600	DETROIT DIESEL 6 CIL, 12.7 L DIESEL	1991-1994	VOLKSWAGEN	SAVEIRO	4 CIL, 1.6 L	2010-2013
KENWORTH	T800	DETROIT DIESEL 6 CIL, 11.1 L DIESEL	1991-1994	3VX650			
KENWORTH	T800	DETROIT DIESEL 6 CIL, 12.7 L DIESEL	1991-1994	IRIZAR	MAN A-82	MAN A-82	2005-2010
KENWORTH	W900	DETROIT DIESEL 6 CIL, 11.1 L DIESEL	1994-2001	IRIZAR	MAN R-33	MAN R-33	2006-2010
KENWORTH	W900	DETROIT DIESEL 6 CIL, 12.7 L DIESEL	1994-2001	4PK1102SF			
3/9500PB				FIAT	DUCATO	4 CIL, 3.0 L DIESEL	2008-2013
FREIGHTLINER	CENTURY CLASS	DETROIT DIESEL 6 CIL, 11.1 L DIESEL	1997-2003	PEUGEOT	MANAGER	4 CIL, 3.0 L DIESEL	2008-2013
FREIGHTLINER	CENTURY CLASS	DETROIT DIESEL 6 CIL, 12.7 L DIESEL	1997-2003	4PK711SF			
FREIGHTLINER	CENTURY CLASS	DETROIT DIESEL 6 CIL, 14.0 L DIESEL	2003-2003	VOLKSWAGEN	CRAFTER	5 CIL, 2.0 L TDI	2013-2014
FREIGHTLINER	COLUMBIA	DETROIT DIESEL 6 CIL, 11.1 L DIESEL	2000-2001	4PK903SF			
FREIGHTLINER	COLUMBIA	DETROIT DIESEL 6 CIL, 12.7 L DIESEL	2000-2003	FIAT	DUCATO	4 CIL, 2.3 L DIESEL	2008-2013
FREIGHTLINER	COLUMBIA	DETROIT DIESEL 6 CIL, 14.0 L DIESEL	2002-2003	4PK922SF			
FREIGHTLINER	FLC	DETROIT DIESEL 6 CIL, 11.1 L DIESEL	1998-1998	FORD	TRANSIT	4 CIL, 2.2 L TDI	2011-2013
FREIGHTLINER	FLC	DETROIT DIESEL 6 CIL, 11.1 L DIESEL	1997-1997	FORD	TRANSIT	4 CIL, 2.2 L TDI	2008-2010
FREIGHTLINER	FLC	DETROIT DIESEL 6 CIL, 12.7 L DIESEL	1996-1998	PEUGEOT	MANAGER	4 CIL, 2.2 L DIESEL	2013-2014
FREIGHTLINER	FLC	DETROIT DIESEL 6 CIL, 12.7 L DIESEL	1997-1997	5592XS			
KENWORTH	C500	DETROIT DIESEL 6 CIL, 11.1 L DIESEL	1991-1994	FIAT	DUCATO	4 CIL, 2.3 L DIESEL	2008-2013
KENWORTH	C500	DETROIT DIESEL 6 CIL, 12.7 L DIESEL	1991-1994	5598XS			
KENWORTH	T600	DETROIT DIESEL 6 CIL, 11.1 L DIESEL	1991-1994	PEUGEOT	PARTNER	4 CIL, 1.6 L DIESEL	2009-2011
KENWORTH	T600	DETROIT DIESEL 6 CIL, 12.7 L DIESEL	1991-1994	PEUGEOT	PARTNER	4 CIL, 1.6 L HDI	2008-2008
KENWORTH	T800	DETROIT DIESEL 6 CIL, 11.1 L DIESEL	1991-1994	5649XS			
KENWORTH	T800	DETROIT DIESEL 6 CIL, 12.7 L DIESEL	1991-1994	VOLKSWAGEN	TRANSPORTER	4 CIL, 2.0 L TDI	2010-2014
3/9525PB				5VX600			
FREIGHTLINER	CLASSIC	DETROIT DIESEL 6 CIL, 11.1 L DIESEL	2001-2002	DINA	F-11	DETROIT DIESEL SERIE 50	1997-1999
FREIGHTLINER	CLASSIC	DETROIT DIESEL 6 CIL, 12.7 L DIESEL	2001-2004				



MASTER SERVICIO PESADO 2014

BANDAS

MARCA	MODELO	MOTOR	AÑOS	MARCA	MODELO	MOTOR	AÑOS
		5VX900		VOLKSWAGEN	VW VAN	4 CIL, 1.8 L	2005-2005
MERCEDES BENZ	BUSSCAR	DDA 560	1997-2001	VOLKSWAGEN	VW VAN	4 CIL, 1.8 L	2006-2006
		6366L				7295	
NISSAN	CHASIS	4 CIL, 2.4 L	1995-2006	VOLKSWAGEN	VW VAN	4 CIL, 1.6 L	2004-2004
NISSAN	ESTAQUITAS	4 CIL, 2.4 L	1995-2009	VOLKSWAGEN	VW VAN	4 CIL, 1.8 L	2006-2006
NISSAN	NP300	4 CIL, 2.4 L	2008-2013	VOLKSWAGEN	VW VAN	4 CIL, 1.8 L	2005-2005
NISSAN	PICK-UP	4 CIL, 2.4 L	1995-2007			7370	
		6370 GS		NISSAN	PICK-UP	4 CIL, 2.4 L	1993-1994
VOLKSWAGEN	PANEL	4 CIL, 1.8 L	1993-1995			7417	
		6400 GS		CHEVROLET	LUV	4 CIL, 2.2 L	2001-2003
NISSAN	ESTAQUITAS	4 CIL, 1.8 L	1993-1994	VOLVO	XPEDITOR	VOLVO VE D7 DIESEL	2000-2000
		6417 GS				7425	
CHEVROLET	LUV	4 CIL, 2.2 L	2000-2000	VOLVO	XPEDITOR	VOLVO VE D7 DIESEL	1999-1999
		6420 GS				7460	
KENWORTH	T300	CUMMINS ISC DIESEL	1998-2005	VOLVO	FE SERIES	VOLVO VE D7 DIESEL	1995-1995
		6463 GS				7490	
VOLVO	7350	D7C	2002-2002	MACK	CS SERIES	RENAULT 6 CIL, 6.2 L DIESEL	2001-2001
		6469MC				7495	
HYUNDAI	H100	4 CIL, 2.4 L	2003-2005	VOLVO	XPEDITOR	VOLVO VE D7 DIESEL	2000-2000
MERCEDES BENZ	SPRINTER	4 CIL, 2.2 L CDI	2003-2013			7512	
MERCEDES BENZ	VITO	4 CIL, 2.2 L CDI	2009-2013	MACK	CS SERIES	RENAULT 6 CIL, 6.2 L DIESEL	2001-2001
		6470MC				7565	
HYUNDAI	H100	4 CIL, 2.4 L	2003-2005	FORD	F-600	FORD 6 CIL, 6.6 L DIESEL	1991-1991
		6596				7570	
KENWORTH	K100	CUMMINS 6 CIL, 14.0 L DIESEL	1991-1991	FORD	F-600	FORD 6 CIL, 6.6 L DIESEL	1991-1993
KENWORTH	K100	CUMMINS N14 DIESEL	1992-1993			7575	
		6607 GS		FORD	F-600	FORD 6 CIL, 7.8 L DIESEL	1991-1991
DODGE	D-600	DODGE V8, 5.9 L	1993-1994			7597	
		6641 GS		FORD	F-600	FORD 6 CIL, 7.8 L DIESEL	1992-1993
IRIZAR	MAN A-82	MAN A-82	2005-2010			7660	
		6DPK1200		FORD	F-600	FORD V8, 6.1 L	1991-1991
VOLKSWAGEN	EUROVAN	4 CIL, 1.9 L DIESEL	2009-2010			8324 GS	
VOLKSWAGEN	EUROVAN	4 CIL, 1.9 L DIESEL	2005-2008	DINA	D-9400 EAGLE	DETROIT DIESEL SERIE 60, 12.7 L	1990-1992
		6PK0725SF		INTERNATIONAL/NAVISTAR	9400	DETROIT DIESEL SERIE 60	1996-1996
VOLKSWAGEN	SAVEIRO	4 CIL, 1.6 L	2010-2013			8345 GS	
		6PK0762SF		CHEVROLET	KODIAK	CATERPILLAR 3116 DIESEL	1997-2000
VOLKSWAGEN	SAVEIRO	4 CIL, 1.6 L	2010-2013	CHEVROLET	KODIAK	CATERPILLAR 3126 DIESEL	2000-2008
		6PK1200SF		DINA	D-7400 HTQ	CATERPILLAR 3126 DIESEL	1996-2000
VOLKSWAGEN	SAVEIRO	4 CIL, 1.6 L	2010-2013	DINA	D-7400 HTQ	CATERPILLAR 3126 E DIESEL	1996-2000
		6PK873SF		STERLING	ACTERRA	CATERPILLAR 3126 DIESEL	2003-2003
FORD	TRANSIT	4 CIL, 2.2 L TDI	2008-2013	STERLING	ACTERRA	CATERPILLAR C7 DIESEL	2004-2007
PEUGEOT	MANAGER	4 CIL, 2.2 L DIESEL	2013-2014	STERLING	L-LINE	CATERPILLAR 3126 DIESEL	2001-2003
		7270				8350 GS	
VOLKSWAGEN	VW VAN	4 CIL, 1.6 L	2004-2004	CHEVROLET	KODIAK	CATERPILLAR 3116 DIESEL	1996-1996



MASTER SERVICIO PESADO 2014

BANDAS

MARCA	MODELO	MOTOR	AÑOS	MARCA	MODELO	MOTOR	AÑOS
DINA	D-500 HTQ	CATERPILLAR 3126 DIESEL	1996-2000	NISSAN	PICK-UP	4 CIL. 2.4 L	1995-2001
DINA	D-600 HTQ	CATERPILLAR 3126 DIESEL	1996-2000	8468 GS			
NISSAN	NP300	4 CIL. 2.5 L DIESEL	2008-2013	HINO	1018 SERIE 500	HINO J05D-TG	2012-2013
8355GS				KENWORTH	T800	CUMMINS ISL	2005-2005
NISSAN	PICK-UP	4 CIL. 2.4 L	1993-1994	KENWORTH	T800	CUMMINS ISL DIESEL	2001-2005
8360 GS				8476 GS			
NISSAN	PICK-UP	4 CIL. 2.4 L	1993-1994	CHEVROLET	KODIAK	GM V8, 7.4 L	1995-2000
8371 GS				8494 GS			
CHEVROLET	LUV	4 CIL. 2.2 L	2000-2000	STERLING	L-LINE	DETROIT DIESEL SERIE 60	2003-2003
STERLING	A-LINE	DETROIT DIESEL SERIE 60	2001-2001	8543 GS			
STERLING	L-LINE	DETROIT DIESEL SERIE 60	2001-2001	KENWORTH	T800	DETROIT DIESEL SERIE 60, 11.1 L	1991-1991
STERLING	SILVER STAR	DETROIT DIESEL SERIE 60	2000-2000	KENWORTH	T800	DETROIT DIESEL SERIE 60, 11.1 L	1990-1990
VOLVO	VNM	CUMMINS N14 DIESEL	1998-2003	KENWORTH	T800	DETROIT DIESEL SERIE 60, 12.7 L	1991-1991
8380 GS				KENWORTH	T800	DETROIT DIESEL SERIE 60, 12.7 L	1990-1990
CHEVROLET	LUV	4 CIL. 2.2 L	2000-2000	8563 GS			
KENWORTH	T800	CUMMINS ISL	2006-2006	KENWORTH	T400	CUMMINS L10 DIESEL	1990-1997
KENWORTH	T800	CUMMINS ISL DIESEL	2006-2009	KENWORTH	T400A	CUMMINS L10 DIESEL	1990-1995
8395 GS				KENWORTH	T400A	CUMMINS M11 DIESEL	1994-1995
CHEVROLET	KODIAK	GM V8, 7.4 L	1995-2000	KENWORTH	T450	CUMMINS L10 DIESEL	1990-1995
INTERNATIONAL/NAVISTAR	5000	CUMMINS N14 DIESEL	1992-1993	KENWORTH	T450	CUMMINS M11 DIESEL	1990-1999
INTERNATIONAL/NAVISTAR	PAYSTAR	CUMMINS N14 DIESEL	1992-1993	KENWORTH	T450B	CUMMINS L10 DIESEL	1990-1991
8400 GS				KENWORTH	T600	CUMMINS L10 DIESEL	1990-1997
CHEVROLET	KODIAK	GM V8, 7.4 L	1995-2000	KENWORTH	T600A	CUMMINS L10 DIESEL	1992-1995
KENWORTH	K100	CUMMINS N14 DIESEL	1992-1993	KENWORTH	T800	CUMMINS L10 DIESEL	1990-1997
8405 GS				KENWORTH	T800	CUMMINS L10 DIESEL	1990-1997
DINA	D-9400 EAGLE	DETROIT DIESEL SERIE 60, 12.7 L	1993-1994	MERCEDES BENZ	1317	OM 366	1990-1994
FREIGHTLINER	FLC	CUMMINS N14 DIESEL	1992-1996	8573 GS			
FREIGHTLINER	FLD	CUMMINS N14 DIESEL	1992-1996	FREIGHTLINER	FLC	CUMMINS L10 DIESEL	1990-1993
INTERNATIONAL/NAVISTAR	5000	CUMMINS N14 DIESEL	2000-2000	FREIGHTLINER	FLD	CUMMINS L10 DIESEL	1990-1993
INTERNATIONAL/NAVISTAR	PAYSTAR	CUMMINS N14 DIESEL	2000-2000	FREIGHTLINER	FLD120	DETROIT DIESEL SERIE 60	1992-1993
KENWORTH	K100	CUMMINS N14 DIESEL	1992-1993	FREIGHTLINER	FLD120	DETROIT DIESEL SERIE 60	1991-1991
MERCEDES BENZ	1417	OM 366	1990-1994	8580 GS			
8416 GS				KENWORTH	T600	CATERPILLAR 3406 DIESEL	1990-1990
FORD	F-800	CUMMINS ISB DIESEL	1999-1999	KENWORTH	T800	CATERPILLAR 3406 DIESEL	1990-1990
FREIGHTLINER	FLC	CUMMINS N14 DIESEL	1992-1996	KENWORTH	W900	CATERPILLAR 3406 DIESEL	1990-1990
FREIGHTLINER	FLD	CUMMINS N14 DIESEL	1992-1996	8594 GS			
KENWORTH	T2000	CUMMINS N14 DIESEL	1996-1996	KENWORTH	T600	DETROIT DIESEL SERIE 60	1990-1994
MERCEDES BENZ	1314	OM 366	1990-1994	KENWORTH	T800	DETROIT DIESEL SERIE 60	1990-1994
8430 GS				KENWORTH	T800	DETROIT DIESEL SERIE 60, 11.1 L	1991-1991
FREIGHTLINER	FLC	CUMMINS N14 DIESEL	1996-1996	KENWORTH	T800	DETROIT DIESEL SERIE 60, 12.7 L	1991-1991
8435 GS				KENWORTH	W900	DETROIT DIESEL SERIE 60	1990-1993
STERLING	A-LINE	CUMMINS N14 DIESEL	2001-2002	SCANIA	SCANIA	DSC11-22	1992-1998
STERLING	L-LINE	CUMMINS N14 DIESEL	2001-2002	8600 GS			
8452L				DINA	S-400	PERKINS 5.8 L DIESEL	1990-1997
NISSAN	CHASIS	4 CIL. 2.4 L	1995-2006	DINA	S-500 CORAZA	PERKINS 5.8 L DIESEL	1990-1997
NISSAN	ESTAQUITAS	4 CIL. 2.4 L	1995-2001	DINA	S-500 CORAZA	PERKINS FASE IV C6-354.4 (6.8 L)	1990-1990



MASTER SERVICIO PESADO 2014

BANDAS

MARCA	MODELO	MOTOR	AÑOS	MARCA	MODELO	MOTOR	AÑOS
FREIGHTLINER	FLC	DETROIT DIESEL SERIE 60	1990-1990	INTERNATIONAL/NAVISTAR	9400	DETROIT DIESEL 6 CIL, 11.1 L DIESEL	1995-1995
FREIGHTLINER	FLD	CATERPILLAR 3406 DIESEL	1990-1990	INTERNATIONAL/NAVISTAR	9400	DETROIT DIESEL 6 CIL, 12.7 L DIESEL	1995-1995
8608 GS				9330			
KENWORTH	T600	CATERPILLAR 3406 DIESEL	1990-1990	INTERNATIONAL/NAVISTAR	9200	CUMMINS N14 DIESEL	1996-1996
KENWORTH	T800	CATERPILLAR 3406 DIESEL	1990-1990	INTERNATIONAL/NAVISTAR	9300	CUMMINS N14 DIESEL	1995-1995
KENWORTH	W900	CATERPILLAR 3406 DIESEL	1990-1990	INTERNATIONAL/NAVISTAR	9400	CUMMINS N14 DIESEL	1995-1995
8616 GS				9335			
FREIGHTLINER	FLD	DETROIT DIESEL SERIE 60	1990-1999	CHEVROLET	C6500	CATERPILLAR 3126 DIESEL	2003-2003
KENWORTH	T600	DETROIT DIESEL SERIE 60	1995-1996	CHEVROLET	C7500	CATERPILLAR 3126 DIESEL	2003-2003
KENWORTH	T800	DETROIT DIESEL SERIE 60	1995-1996	CHEVROLET	C8500	CATERPILLAR 3126 DIESEL	2003-2003
8625 GS				9341			
ISUZU	ELF 400	4HK1-TC	2006-2013	CHEVROLET	C5500	CATERPILLAR 3116 DIESEL	1999-1999
ISUZU	ELF 500	4HK1-TC	2009-2013	CHEVROLET	C5500	CATERPILLAR 3126 DIESEL	1998-2002
ISUZU	ELF 600	4HK1-TC	2009-2013	CHEVROLET	C6500	CATERPILLAR 3116 DIESEL	1997-2000
ISUZU	ELF 600-BUS	4HK1-TC	2011-2013	CHEVROLET	C6500	CATERPILLAR 3126 DIESEL	1998-2002
8643 GS				CHEVROLET	C7500	CATERPILLAR 3116 DIESEL	1997-2000
CHEVROLET	KODIAK	GM V8, 7.4 L	1995-2000	CHEVROLET	C7500	CATERPILLAR 3126 DIESEL	1998-2002
KENWORTH	T600	CATERPILLAR 3406 DIESEL	1990-1990	CHEVROLET	C8500	CATERPILLAR 3116 DIESEL	1997-2000
8650 GS				CHEVROLET	C8500	CATERPILLAR 3126 DIESEL	1998-2002
DINA	F-11	DETROIT DIESEL SERIE 50	1997-1999	KENWORTH	T300	CATERPILLAR 3126 DIESEL	1996-2003
KENWORTH	T600	CATERPILLAR 3406 DIESEL	1990-1990	STERLING	ACTERRA	CATERPILLAR 3126 DIESEL	2001-2004
KENWORTH	T800	CATERPILLAR 3406 DIESEL	1990-1990	STERLING	ACTERRA	CATERPILLAR C7 DIESEL	2004-2006
8680 GS				STERLING	L-LINE	CATERPILLAR 3126 DIESEL	2000-2004
CHEVROLET	KODIAK	GM V8, 7.4 L	1995-2000	STERLING	L-LINE	CATERPILLAR C7 DIESEL	2004-2004
9313				9360			
INTERNATIONAL/NAVISTAR	8200	DETROIT DIESEL 6 CIL, 11.1 L DIESEL	1995-1995	FORD	F-600	FORD V8, 6.1 L	1991-1991
INTERNATIONAL/NAVISTAR	8200	DETROIT DIESEL 6 CIL, 12.7 L DIESEL	1995-1995	FORD	F-600	FORD V8, 7.0 L	1991-1994
INTERNATIONAL/NAVISTAR	9100	DETROIT DIESEL SERIE 60	1998-1998	9365			
INTERNATIONAL/NAVISTAR	9200	DETROIT DIESEL 6 CIL, 11.1 L DIESEL	1995-1997	NISSAN	ESTAQUITAS	4 CIL, 2.4 L	2002-2009
INTERNATIONAL/NAVISTAR	9200	DETROIT DIESEL 6 CIL, 12.7 L DIESEL	1995-1997	NISSAN	PICK-UP	4 CIL, 2.4 L	2002-2007
INTERNATIONAL/NAVISTAR	9200	DETROIT DIESEL SERIE 60	1998-1998	9365L			
INTERNATIONAL/NAVISTAR	9400	DETROIT DIESEL 6 CIL, 11.1 L DIESEL	1996-1996	NISSAN	NP300	4 CIL, 2.4 L	2008-2013
INTERNATIONAL/NAVISTAR	9400	DETROIT DIESEL 6 CIL, 11.1 L DIESEL	1995-1995	9370			
INTERNATIONAL/NAVISTAR	9400	DETROIT DIESEL 6 CIL, 12.7 L DIESEL	1996-1996	STERLING	A-LINE	DETROIT DIESEL 6 CIL, 11.1 L DIESEL	2000-2000
INTERNATIONAL/NAVISTAR	9400	DETROIT DIESEL 6 CIL, 12.7 L DIESEL	1995-1995	STERLING	A-LINE	DETROIT DIESEL 6 CIL, 12.7 L DIESEL	2000-2000
INTERNATIONAL/NAVISTAR	9400	DETROIT DIESEL SERIE 60	1997-1998	STERLING	L-LINE	DETROIT DIESEL 6 CIL, 11.1 L DIESEL	2000-2001
INTERNATIONAL/NAVISTAR	9600	DETROIT DIESEL 6 CIL, 11.1 L DIESEL	1996-1996	STERLING	L-LINE	DETROIT DIESEL 6 CIL, 12.7 L DIESEL	2000-2001
INTERNATIONAL/NAVISTAR	9600	DETROIT DIESEL 6 CIL, 12.7 L DIESEL	1995-1995	VOLVO	AUTOCAR	CUMMINS N14 DIESEL	1999-2001
INTERNATIONAL/NAVISTAR	9700	DETROIT DIESEL 6 CIL, 11.1 L DIESEL	1996-1996	VOLVO	VNL	CUMMINS N14 DIESEL	1998-2003
INTERNATIONAL/NAVISTAR	9700	DETROIT DIESEL 6 CIL, 12.7 L DIESEL	1996-1996	VOLVO	WG SERIES	CUMMINS N14 DIESEL	1996-1997
INTERNATIONAL/NAVISTAR	9800	DETROIT DIESEL SERIE 60	1997-1997	VOLVO	WIA SERIES	CUMMINS N14 DIESEL	1996-1998
9319				9375			
GIANT MOTORS	GF-8	4 CIL, 1.0 L	2007-2008	FORD	F-650 SUPER DUTY	CUMMINS ISB DIESEL	2000-2004
GIANT MOTORS	GF-900	4 CIL, 1.0 L	2007-2008	FORD	F-750 SUPER DUTY	CUMMINS ISB DIESEL	2000-2004
9325				9378			



MASTER SERVICIO PESADO 2014

BANDAS

MARCA	MODELO	MOTOR	AÑOS	MARCA	MODELO	MOTOR	AÑOS
CHEVROLET	LUV	4 CIL, 2.2 L	2001-2003	INTERNATIONAL/NAVISTAR	9100	CUMMINS N14 DIESEL	1999-1999
		9380		INTERNATIONAL/NAVISTAR	9100I	CUMMINS N14 DIESEL	2000-2003
CHEVROLET	LUV	4 CIL, 2.2 L	2001-2003	INTERNATIONAL/NAVISTAR	9200	CUMMINS N14 DIESEL	1996-1998
		9390		INTERNATIONAL/NAVISTAR	9200I	CUMMINS N14 DIESEL	1999-1999
CHEVROLET	C5500	GM V8 7.4 L	1999-2000	INTERNATIONAL/NAVISTAR	9200I	CUMMINS N14 DIESEL	2000-2003
CHEVROLET	C6500	GM V8 7.4 L	1999-2000	INTERNATIONAL/NAVISTAR	9300	CUMMINS N14 DIESEL	1995-1999
CHEVROLET	C7500	GM V8 7.4 L	1999-2000	INTERNATIONAL/NAVISTAR	9400	CUMMINS N14 DIESEL	1995-1998
CHEVROLET	C8500	GM V8 7.4 L	1999-2000	INTERNATIONAL/NAVISTAR	9400	CUMMINS N14 DIESEL	1999-1999
KENWORTH	K300	CUMMINS C Series 8.3 L DIESEL	1993-1997	INTERNATIONAL/NAVISTAR	9400I	CUMMINS N14 DIESEL	2000-2003
MACK	MR SERIES	MACK 6 CIL, 12.0 L DIESEL	2001-2002	INTERNATIONAL/NAVISTAR	9800	CUMMINS N14 DIESEL	1997-1999
		9395		INTERNATIONAL/NAVISTAR	9900	CUMMINS N14 DIESEL	1999-1999
CHEVROLET	C5500	GM V8 6.0 L	1997-1998	INTERNATIONAL/NAVISTAR	9900I	CUMMINS N14 DIESEL	2000-2003
CHEVROLET	C5500	GM V8 7.0 L	1997-1998	INTERNATIONAL/NAVISTAR	9900IX	CUMMINS N14 DIESEL	2000-2003
CHEVROLET	C5500	GM V8 7.4 L	1999-2000	KENWORTH	K100	CUMMINS 6 CIL, 14.0 L DIESEL	1991-1991
CHEVROLET	C6500	GM V8 6.0 L	1997-1998	KENWORTH	K100	CUMMINS N14 DIESEL	1992-1993
CHEVROLET	C6500	GM V8 7.0 L	1997-1998	VOLVO	XPEDITOR	CATERPILLAR 3306 DIESEL	1996-1996
CHEVROLET	C6500	GM V8 7.4 L	1999-2000			9412	
CHEVROLET	C7500	GM V8 6.0 L	1997-1998	FORD	F-600	CUMMINS B Series 5.9 L DIESEL	1992-1994
CHEVROLET	C7500	GM V8 7.0 L	1997-1998	FREIGHTLINER	ARGOSY	CUMMINS ISM DIESEL	2000-2000
CHEVROLET	C7500	GM V8 7.4 L	1999-2000	FREIGHTLINER	FLC	CUMMINS N14 DIESEL	1994-1996
CHEVROLET	C8500	GM V8 6.0 L	1997-1998	FREIGHTLINER	FLC	CUMMINS N14 DIESEL	1991-1993
CHEVROLET	C8500	GM V8 7.0 L	1997-1998	FREIGHTLINER	FLD	CUMMINS N14 DIESEL	1994-1996
CHEVROLET	C8500	GM V8 7.4 L	1999-2000	FREIGHTLINER	FLD	CUMMINS N14 DIESEL	1991-1993
KENWORTH	K100	CUMMINS 6 CIL, 14.0 L DIESEL	1991-1991	INTERNATIONAL/NAVISTAR	9200	CUMMINS N14 DIESEL	1996-1996
KENWORTH	K100	CUMMINS N14 DIESEL	1992-1993			9415	
MACK	LE SERIES	MACK AI DIESEL	2005-2005	VOLVO	XPEDITOR	VOLVO VE D7 DIESEL	1999-1999
		9400				9420	
KENWORTH	C500	CATERPILLAR 3306 DIESEL	1991-1992	FORD	F-600	CUMMINS B Series 5.9 L DIESEL	1992-1994
KENWORTH	K100	CUMMINS 6 CIL, 14.0 L DIESEL	1991-1991	FREIGHTLINER	FLC	CUMMINS N14 DIESEL	1994-1996
KENWORTH	K100	CUMMINS N14 DIESEL	1992-1993	FREIGHTLINER	FLC	CUMMINS N14 DIESEL	1991-1993
KENWORTH	T600	CUMMINS 6 CIL, 14.0 L DIESEL	1991-1991	FREIGHTLINER	FLD	CUMMINS N14 DIESEL	1994-1996
KENWORTH	T600	CUMMINS N14 DIESEL	1992-1996	FREIGHTLINER	FLD	CUMMINS N14 DIESEL	1991-1993
KENWORTH	T800	CUMMINS 6 CIL, 14.0 L DIESEL	1991-1991	INTERNATIONAL/NAVISTAR	9300	CUMMINS N14 DIESEL	1995-1995
KENWORTH	T800	CUMMINS N14 DIESEL	1992-1996	INTERNATIONAL/NAVISTAR	9400	CUMMINS N14 DIESEL	1995-1995
		9405		INTERNATIONAL/NAVISTAR	9600	CUMMINS N14 DIESEL	1996-1996
FREIGHTLINER	FLC	CUMMINS N14 DIESEL	1994-1996	INTERNATIONAL/NAVISTAR	9600	CUMMINS N14 DIESEL	1996-1996
FREIGHTLINER	FLC	CUMMINS N14 DIESEL	1991-1993	INTERNATIONAL/NAVISTAR	9700	CUMMINS N14 DIESEL	1996-1996
FREIGHTLINER	FLD	CUMMINS N14 DIESEL	1994-1996	INTERNATIONAL/NAVISTAR	9700	CUMMINS N14 DIESEL	1996-1996
FREIGHTLINER	FLD	CUMMINS N14 DIESEL	1991-1993	KENWORTH	T2000	CUMMINS N14 DIESEL	1997-2000
INTERNATIONAL/NAVISTAR	5500I	CUMMINS N14 DIESEL	2000-2003	KENWORTH	T600	CUMMINS 6 CIL, 14.0 L DIESEL	1991-1991
INTERNATIONAL/NAVISTAR	5600I	CUMMINS N14 DIESEL	2000-2003	KENWORTH	T600	CUMMINS N14 DIESEL	1992-1996
INTERNATIONAL/NAVISTAR	5900I	CUMMINS N14 DIESEL	2000-2003	KENWORTH	T800	CUMMINS 6 CIL, 14.0 L DIESEL	1991-1991
INTERNATIONAL/NAVISTAR	8100	CUMMINS N14 DIESEL	1997-1999	KENWORTH	T800	CUMMINS N14 DIESEL	1992-1996
INTERNATIONAL/NAVISTAR	8200	CUMMINS N14 DIESEL	1997-1998	STERLING	A-LINE	CUMMINS N14 DIESEL	2000-2003
INTERNATIONAL/NAVISTAR	9100	CUMMINS N14 DIESEL	1998-1998	STERLING	L-LINE	CATERPILLAR 3406 DIESEL	2000-2001



MASTER SERVICIO PESADO 2014

BANDAS

MARCA	MODELO	MOTOR	AÑOS	MARCA	MODELO	MOTOR	AÑOS
STERLING	L-LINE	CUMMINS N14 DIESEL	2000-2003	FORD	F-600	FORD V8, 6.1 L	1991-1991
9425				FORD	F-600	FORD V8, 7.0 L	1991-1994
FREIGHTLINER	FLC	CUMMINS N14 DIESEL	1994-1996	INTERNATIONAL/NAVISTAR	8100	CUMMINS N14 DIESEL	1998-1999
FREIGHTLINER	FLC	CUMMINS N14 DIESEL	1991-1993	INTERNATIONAL/NAVISTAR	9200	CUMMINS N14 DIESEL	1996-1996
FREIGHTLINER	FLD	CUMMINS N14 DIESEL	1994-1996	STERLING	A-LINE	CATERPILLAR C10 DIESEL	2000-2001
FREIGHTLINER	FLD	CUMMINS N14 DIESEL	1991-1993	STERLING	A-LINE	CATERPILLAR C12 DIESEL	2000-2001
KENWORTH	T600	CATERPILLAR 3406 DIESEL	1991-1996	STERLING	L-LINE	CATERPILLAR C10 DIESEL	2000-2004
KENWORTH	T600	CUMMINS N14 DIESEL	2000-2001	STERLING	L-LINE	CATERPILLAR C10 DIESEL	2002-2002
KENWORTH	T800	CATERPILLAR 3406 DIESEL	1991-1996	STERLING	L-LINE	CATERPILLAR C12 DIESEL	2000-2004
KENWORTH	T800	CUMMINS N14 DIESEL	1997-2003	STERLING	L-LINE	CATERPILLAR C12 DIESEL	2002-2002
KENWORTH	W900	CUMMINS N14 DIESEL	1993-1996	9447			
KENWORTH	W900	CUMMINS N14 DIESEL	1997-2003	FORD	F-600	FORD V8, 6.1 L	1991-1991
9430				FORD	F-600	FORD V8, 6.1 L	1991-1991
FREIGHTLINER	FLC	CUMMINS N14 DIESEL	1994-1996	FORD	F-600	FORD V8, 7.0 L	1991-1994
FREIGHTLINER	FLC	CUMMINS N14 DIESEL	1991-1993	FORD	F-600	FORD V8, 7.0 L	1991-1994
FREIGHTLINER	FLD	CUMMINS N14 DIESEL	1994-1996	FREIGHTLINER	COLUMBIA	CUMMINS N14 DIESEL	2003-2003
FREIGHTLINER	FLD	CUMMINS N14 DIESEL	1991-1993	FREIGHTLINER	FLC	CUMMINS N14 DIESEL	1994-1996
INTERNATIONAL/NAVISTAR	5000	CUMMINS N14 DIESEL	1995-1998	FREIGHTLINER	FLC	CUMMINS N14 DIESEL	1991-1993
INTERNATIONAL/NAVISTAR	8100	CUMMINS N14 DIESEL	1995-1996	FREIGHTLINER	FLD	CUMMINS N14 DIESEL	1994-1996
INTERNATIONAL/NAVISTAR	8200	CUMMINS N14 DIESEL	1995-1996	FREIGHTLINER	FLD	CUMMINS N14 DIESEL	1991-1993
INTERNATIONAL/NAVISTAR	9200	CUMMINS N14 DIESEL	1996-1996	INTERNATIONAL/NAVISTAR	5000	CATERPILLAR C10 DIESEL	1998-2000
INTERNATIONAL/NAVISTAR	9300	CUMMINS N14 DIESEL	1995-1995	INTERNATIONAL/NAVISTAR	5000	CATERPILLAR C12 DIESEL	1998-1999
INTERNATIONAL/NAVISTAR	9400	CUMMINS N14 DIESEL	1995-1995	INTERNATIONAL/NAVISTAR	5000	CUMMINS N14 DIESEL	1999-1999
INTERNATIONAL/NAVISTAR	9600	CUMMINS N14 DIESEL	1996-1996	INTERNATIONAL/NAVISTAR	5500I	CATERPILLAR C10 DIESEL	2000-2002
INTERNATIONAL/NAVISTAR	9700	CUMMINS N14 DIESEL	1996-1996	INTERNATIONAL/NAVISTAR	5500I	CATERPILLAR C12 DIESEL	2000-2002
KENWORTH	K100	CUMMINS 6 CIL, 14.0 L DIESEL	1991-1991	INTERNATIONAL/NAVISTAR	5500I	CUMMINS N14 DIESEL	2000-2003
KENWORTH	K100	CUMMINS N14 DIESEL	1992-1993	INTERNATIONAL/NAVISTAR	5600I	CATERPILLAR C10 DIESEL	2000-2002
MACK	CL SERIES	MACK 6 CIL, 12.0 L DIESEL	2001-2001	INTERNATIONAL/NAVISTAR	5600I	CATERPILLAR C12 DIESEL	2000-2002
MACK	DM SERIES	MACK 6 CIL, 12.0 L DIESEL	2001-2001	INTERNATIONAL/NAVISTAR	5600I	CUMMINS N14 DIESEL	2000-2003
MACK	RD SERIES	MACK 6 CIL, 12.0 L DIESEL	2001-2002	INTERNATIONAL/NAVISTAR	5900I	CATERPILLAR C10 DIESEL	2000-2002
9435				INTERNATIONAL/NAVISTAR	5900I	CATERPILLAR C12 DIESEL	2000-2002
FORD	F-600	FORD V8, 6.1 L	1991-1991	INTERNATIONAL/NAVISTAR	5900I	CUMMINS N14 DIESEL	2000-2003
FORD	F-600	FORD V8, 7.0 L	1991-1994	INTERNATIONAL/NAVISTAR	8100	CATERPILLAR C10 DIESEL	2000-2001
FREIGHTLINER	CENTURY CLASS	CUMMINS N14 DIESEL	1996-1998	INTERNATIONAL/NAVISTAR	8100	CUMMINS N14 DIESEL	1995-1997
FREIGHTLINER	CENTURY CLASS	CUMMINS N14 DIESEL	1999-2001	INTERNATIONAL/NAVISTAR	8200	CUMMINS N14 DIESEL	1995-1998
FREIGHTLINER	CLASSIC	CUMMINS N14 DIESEL	2001-2002	INTERNATIONAL/NAVISTAR	9100	CUMMINS N14 DIESEL	1998-1999
FREIGHTLINER	CLASSIC XL	CUMMINS N14 DIESEL	2001-2003	INTERNATIONAL/NAVISTAR	9100I	CUMMINS N14 DIESEL	2000-2003
FREIGHTLINER	FLC	CUMMINS N14 DIESEL	1994-1998	INTERNATIONAL/NAVISTAR	9200	CUMMINS N14 DIESEL	1996-1999
FREIGHTLINER	FLC	CUMMINS N14 DIESEL	1991-1993	INTERNATIONAL/NAVISTAR	9200I	CUMMINS N14 DIESEL	2000-2003
FREIGHTLINER	FLD	CUMMINS N14 DIESEL	1994-1996	INTERNATIONAL/NAVISTAR	9300	CUMMINS N14 DIESEL	1995-1999
FREIGHTLINER	FLD	CUMMINS N14 DIESEL	1991-1993	INTERNATIONAL/NAVISTAR	9400	CUMMINS N14 DIESEL	1995-1999
FREIGHTLINER	FLD	CUMMINS N14 DIESEL	1997-2003	INTERNATIONAL/NAVISTAR	9400I	CUMMINS N14 DIESEL	2000-2003
STERLING	A-LINE	CUMMINS N14 DIESEL	2000-2003	INTERNATIONAL/NAVISTAR	9900	CUMMINS N14 DIESEL	1999-1999
STERLING	L-LINE	CUMMINS N14 DIESEL	2000-2003	INTERNATIONAL/NAVISTAR	9900I	CUMMINS N14 DIESEL	2000-2003
9440				INTERNATIONAL/NAVISTAR	9900IX	CUMMINS N14 DIESEL	2000-2003



MASTER SERVICIO PESADO 2014

BANDAS

MARCA	MODELO	MOTOR	AÑOS	MARCA	MODELO	MOTOR	AÑOS
KENWORTH	C500	DETROIT DIESEL 6 CIL, 11.1 L DIESEL	1991-1994	FORD	F-600	FORD V8, 7.0 L	1991-1994
KENWORTH	C500	DETROIT DIESEL 6 CIL, 12.7 L DIESEL	1991-1994	FORD	F-600	FORD V8, 7.0 L	1991-1994
KENWORTH	T600	DETROIT DIESEL 6 CIL, 11.1 L DIESEL	1991-1999	FREIGHTLINER	FLC	CUMMINS N14 DIESEL	1991-1996
KENWORTH	T600	DETROIT DIESEL 6 CIL, 12.7 L DIESEL	1991-1999	FREIGHTLINER	FLD	CUMMINS N14 DIESEL	1991-2000
KENWORTH	T800	DETROIT DIESEL 6 CIL, 11.1 L DIESEL	1991-2001	HINO	1018 SERIE 500	HINO J05D-TG	2012-2013
KENWORTH	T800	DETROIT DIESEL 6 CIL, 12.7 L DIESEL	1991-2001	INTERNATIONAL/NAVISTAR	8100	CATERPILLAR 3176 DIESEL	1995-1997
VOLVO	WG SERIES	CATERPILLAR 3306 DIESEL	1996-1996	INTERNATIONAL/NAVISTAR	8100	CATERPILLAR C10 DIESEL	1998-1998
VOLVO	XPEDITOR	CATERPILLAR 3306 DIESEL	1996-1996	INTERNATIONAL/NAVISTAR	8100	CUMMINS N14 DIESEL	1998-1999
		9451		INTERNATIONAL/NAVISTAR	9100	CATERPILLAR C10 DIESEL	1998-1999
FORD	F-600	FORD V8, 6.1 L	1991-1991	INTERNATIONAL/NAVISTAR	9100	CATERPILLAR C12 DIESEL	1998-1999
FORD	F-600	FORD V8, 6.1 L	1991-1991	INTERNATIONAL/NAVISTAR	9100I	CATERPILLAR C10 DIESEL	2000-2003
FORD	F-600	FORD V8, 7.0 L	1991-1994	INTERNATIONAL/NAVISTAR	9100I	CATERPILLAR C12 DIESEL	2000-2003
FORD	F-600	FORD V8, 7.0 L	1991-1994	INTERNATIONAL/NAVISTAR	9200	CATERPILLAR C10 DIESEL	1996-1999
FREIGHTLINER	CENTURY CLASS	CUMMINS N14 DIESEL	1996-2001	INTERNATIONAL/NAVISTAR	9200	CATERPILLAR C12 DIESEL	1996-1999
FREIGHTLINER	CLASSIC	CUMMINS N14 DIESEL	2001-2002	INTERNATIONAL/NAVISTAR	9200	CUMMINS N14 DIESEL	1996-1997
FREIGHTLINER	CLASSIC XL	CUMMINS N14 DIESEL	2001-2003	INTERNATIONAL/NAVISTAR	9200I	CATERPILLAR C10 DIESEL	2000-2003
FREIGHTLINER	COLUMBIA	CUMMINS N14 DIESEL	2003-2003	INTERNATIONAL/NAVISTAR	9200I	CATERPILLAR C12 DIESEL	2000-2003
FREIGHTLINER	FLC	CATERPILLAR 3176 DIESEL	1994-1996	INTERNATIONAL/NAVISTAR	9300	CATERPILLAR C10 DIESEL	1996-1998
FREIGHTLINER	FLC	CATERPILLAR 3176 DIESEL	1991-1993	INTERNATIONAL/NAVISTAR	9300	CATERPILLAR C12 DIESEL	1996-1998
FREIGHTLINER	FLC	CUMMINS N14 DIESEL	1994-1996	INTERNATIONAL/NAVISTAR	9300	CUMMINS N14 DIESEL	1995-1997
FREIGHTLINER	FLC	CUMMINS N14 DIESEL	1991-1993	INTERNATIONAL/NAVISTAR	9400	CATERPILLAR C10 DIESEL	1996-1999
FREIGHTLINER	FLC	CUMMINS N14 DIESEL	1997-1998	INTERNATIONAL/NAVISTAR	9400	CATERPILLAR C12 DIESEL	1996-1999
FREIGHTLINER	FLC	CUMMINS N14 DIESEL	1991-1996	INTERNATIONAL/NAVISTAR	9400	CUMMINS N14 DIESEL	1995-1997
FREIGHTLINER	FLD	CATERPILLAR 3176 DIESEL	1994-1996	INTERNATIONAL/NAVISTAR	9400I	CATERPILLAR C10 DIESEL	2000-2002
FREIGHTLINER	FLD	CATERPILLAR 3176 DIESEL	1991-1993	INTERNATIONAL/NAVISTAR	9400I	CATERPILLAR C12 DIESEL	2000-2003
FREIGHTLINER	FLD	CUMMINS N14 DIESEL	1994-1996	INTERNATIONAL/NAVISTAR	9900	CATERPILLAR C10 DIESEL	1999-1999
FREIGHTLINER	FLD	CUMMINS N14 DIESEL	1991-1993	INTERNATIONAL/NAVISTAR	9900	CATERPILLAR C12 DIESEL	1999-1999
FREIGHTLINER	FLD	CUMMINS N14 DIESEL	2001-2003	INTERNATIONAL/NAVISTAR	9900I	CATERPILLAR C10 DIESEL	2000-2002
FREIGHTLINER	FLD	CUMMINS N14 DIESEL	1991-1996	INTERNATIONAL/NAVISTAR	9900I	CATERPILLAR C12 DIESEL	2000-2003
KENWORTH	T2000	CUMMINS N14 DIESEL	1997-1997	INTERNATIONAL/NAVISTAR	9900IX	CATERPILLAR C10 DIESEL	2000-2002
KENWORTH	T600	CUMMINS N14 DIESEL	1997-2001	INTERNATIONAL/NAVISTAR	9900IX	CATERPILLAR C12 DIESEL	2000-2003
KENWORTH	T800	CUMMINS N14 DIESEL	1998-2003	KENWORTH	T600	CATERPILLAR 3406 DIESEL	1991-1996
KENWORTH	W900	CUMMINS N14 DIESEL	1998-2003	KENWORTH	T600	CUMMINS 6 CIL, 14.0 L DIESEL	1991-1991
STERLING	L-LINE	CATERPILLAR 3406 DIESEL	2000-2001	KENWORTH	T600	CUMMINS N14 DIESEL	1992-1996
VOLVO	AUTOCAR	CUMMINS N14 DIESEL	1999-2001	KENWORTH	T800	CATERPILLAR 3406 DIESEL	1991-1996
VOLVO	VNL	CUMMINS N14 DIESEL	1998-1999	KENWORTH	T800	CUMMINS 6 CIL, 14.0 L DIESEL	1991-1991
VOLVO	WG SERIES	CATERPILLAR 3306 DIESEL	1996-1996	KENWORTH	T800	CUMMINS N14 DIESEL	1992-1997
VOLVO	WG SERIES	CUMMINS N14 DIESEL	1996-1997	KENWORTH	W900	CUMMINS ISC DIESEL	2003-2004
VOLVO	WIA SERIES	CUMMINS N14 DIESEL	1996-1998	KENWORTH	W900	CUMMINS N14 DIESEL	1993-1997
		9455		STERLING	L-LINE	CUMMINS ISC DIESEL	2000-2003
NISSAN	ESTAQUITAS	4 CIL, 2.4 L	2002-2009	VOLVO	WG SERIES	CATERPILLAR 3306 DIESEL	1996-1997
NISSAN	PICK-UP	4 CIL, 2.4 L	2002-2007	VOLVO	WG SERIES	CUMMINS N14 DIESEL	1996-1997
		9463		VOLVO	WIA SERIES	CUMMINS N14 DIESEL	1996-1998
FORD	F-600	FORD V8, 6.1 L	1991-1991			9463 GS	
FORD	F-600	FORD V8, 6.1 L	1991-1991	MERCEDES BENZ	BUSSCAR	MB 906	2002-2008



MASTER SERVICIO PESADO 2014

BANDAS

MARCA	MODELO	MOTOR	AÑOS	MARCA	MODELO	MOTOR	AÑOS
9465				CHEVROLET	C7500	GM V8 7.4 L	1999-2000
STERLING	A-LINE	CATERPILLAR C10 DIESEL	2000-2001	CHEVROLET	C8500	GM V8 6.0 L	1997-1998
STERLING	A-LINE	CATERPILLAR C12 DIESEL	2000-2001	CHEVROLET	C8500	GM V8 7.0 L	1997-1998
STERLING	L-LINE	CATERPILLAR C10 DIESEL	2000-2004	CHEVROLET	C8500	GM V8 7.4 L	1999-2000
STERLING	L-LINE	CATERPILLAR C12 DIESEL	2000-2004	MACK	CS SERIES	RENAULT 6 CIL, 6.2 L DIESEL	2001-2001
9470				VOLVO	XPEDITOR	CATERPILLAR 3306 DIESEL	1999-1999
FREIGHTLINER	FLC	CATERPILLAR 3176 DIESEL	1994-1996	9480			
FREIGHTLINER	FLC	CATERPILLAR 3176 DIESEL	1991-1993	FORD	F-600	FORD V8, 6.1 L	1991-1991
FREIGHTLINER	FLD	CATERPILLAR 3176 DIESEL	1994-1996	FORD	F-600	FORD V8, 7.0 L	1994-1994
FREIGHTLINER	FLD	CATERPILLAR 3176 DIESEL	1991-1993	FORD	F-600	FORD V8, 7.0 L	1991-1994
INTERNATIONAL/NAVISTAR	9300	CUMMINS N14 DIESEL	1995-1995	FORD	F-600	FORD V8, 7.0 L	1991-1993
INTERNATIONAL/NAVISTAR	9400	CUMMINS N14 DIESEL	1995-1995	FORD	F-600	FORD V8, 7.0 L	1991-1994
INTERNATIONAL/NAVISTAR	9600	CUMMINS N14 DIESEL	1996-1996	FREIGHTLINER	FLC	CATERPILLAR 3176 DIESEL	1994-1996
INTERNATIONAL/NAVISTAR	9700	CUMMINS N14 DIESEL	1996-1996	FREIGHTLINER	FLC	CATERPILLAR 3176 DIESEL	1991-1993
KENWORTH	C500	DETROIT DIESEL 6 CIL, 11.1 L DIESEL	1991-1994	FREIGHTLINER	FLD	CATERPILLAR 3176 DIESEL	1994-1996
KENWORTH	C500	DETROIT DIESEL 6 CIL, 12.7 L DIESEL	1991-1994	FREIGHTLINER	FLD	CATERPILLAR 3176 DIESEL	1991-1993
KENWORTH	K100	CUMMINS 6 CIL, 14.0 L DIESEL	1991-1991	KENWORTH	C500	CATERPILLAR 3306 DIESEL	1991-1992
KENWORTH	K100	CUMMINS N14 DIESEL	1992-1993	KENWORTH	K300	CUMMINS B Series 5.9 L DIESEL	1995-1996
KENWORTH	T2000	DETROIT DIESEL 6 CIL, 11.1 L DIESEL	1997-2000	KENWORTH	K300	CUMMINS ISB DIESEL	2000-2001
KENWORTH	T2000	DETROIT DIESEL 6 CIL, 12.7 L DIESEL	1997-2000	STERLING	ACTERRA	CUMMINS ISC DIESEL	2005-2007
KENWORTH	T600	CUMMINS 6 CIL, 14.0 L DIESEL	1991-1991	STERLING	A-LINE	CATERPILLAR 3406 DIESEL	2000-2001
KENWORTH	T600	CUMMINS N14 DIESEL	1992-1996	STERLING	A-LINE	CUMMINS ISM DIESEL	2000-2001
KENWORTH	T600	DETROIT DIESEL 6 CIL, 11.1 L DIESEL	1991-1994	STERLING	L-LINE	CUMMINS ISM DIESEL	2000-2003
KENWORTH	T600	DETROIT DIESEL 6 CIL, 12.7 L DIESEL	1991-1994	VOLVO	VNL	CATERPILLAR 3406 DIESEL	1997-1998
KENWORTH	T800	CATERPILLAR 3306 DIESEL	1991-1992	9485			
KENWORTH	T800	CUMMINS 6 CIL, 14.0 L DIESEL	1991-1991	KENWORTH	K100	CUMMINS C Series 8.3 L DIESEL	1992-1993
KENWORTH	T800	CUMMINS N14 DIESEL	1992-1996	STERLING	A-LINE	CATERPILLAR 3406 DIESEL	2000-2001
KENWORTH	T800	DETROIT DIESEL 6 CIL, 11.1 L DIESEL	1991-1994	STERLING	A-LINE	CATERPILLAR C15 DIESEL	2000-2001
KENWORTH	T800	DETROIT DIESEL 6 CIL, 12.7 L DIESEL	1991-1994	STERLING	A-LINE	CATERPILLAR C16 DIESEL	2000-2000
KENWORTH	W900	CUMMINS N14 DIESEL	1993-1996	STERLING	L-LINE	CATERPILLAR C15 DIESEL	2001-2002
KENWORTH	W900	DETROIT DIESEL 6 CIL, 11.1 L DIESEL	1994-2001	STERLING	L-LINE	CATERPILLAR C16 DIESEL	2001-2001
KENWORTH	W900	DETROIT DIESEL 6 CIL, 12.7 L DIESEL	1994-2001	STERLING	SILVER STAR	DETROIT DIESEL SERIE 60	2000-2000
STERLING	A-LINE	CATERPILLAR C15 DIESEL	2000-2001	9490			
STERLING	A-LINE	CATERPILLAR C16 DIESEL	2000-2000	KENWORTH	C500	DETROIT DIESEL 6 CIL, 11.1 L DIESEL	1991-1994
STERLING	L-LINE	CATERPILLAR C15 DIESEL	2001-2002	KENWORTH	C500	DETROIT DIESEL 6 CIL, 12.7 L DIESEL	1991-1994
STERLING	L-LINE	CATERPILLAR C16 DIESEL	2001-2001	KENWORTH	T600	DETROIT DIESEL 6 CIL, 11.1 L DIESEL	1991-1994
9476				KENWORTH	T600	DETROIT DIESEL 6 CIL, 12.7 L DIESEL	1991-1994
CHEVROLET	C5500	GM V8 6.0 L	1997-1998	KENWORTH	T800	DETROIT DIESEL 6 CIL, 11.1 L DIESEL	1991-1994
CHEVROLET	C5500	GM V8 7.0 L	1997-1998	KENWORTH	T800	DETROIT DIESEL 6 CIL, 12.7 L DIESEL	1991-1994
CHEVROLET	C5500	GM V8 7.4 L	1999-2000	KENWORTH	W900	DETROIT DIESEL 6 CIL, 11.1 L DIESEL	1991-1993
CHEVROLET	C6500	GM V8 6.0 L	1997-1998	KENWORTH	W900	DETROIT DIESEL 6 CIL, 12.7 L DIESEL	1991-1993
CHEVROLET	C6500	GM V8 7.0 L	1997-1998	MACK	CS SERIES	RENAULT 6 CIL, 6.2 L DIESEL	2001-2001
CHEVROLET	C6500	GM V8 7.4 L	1999-2000	MACK	CX SERIES	MACK 6 CIL, 12.0 L DIESEL	2001-2002
CHEVROLET	C7500	GM V8 6.0 L	1997-1998	STERLING	L-LINE	CATERPILLAR 3306 DIESEL	2000-2000
CHEVROLET	C7500	GM V8 7.0 L	1997-1998	VOLVO	AUTOCAR	DETROIT DIESEL 6 CIL, 11.1 L DIESEL	1999-1999



MASTER SERVICIO PESADO 2014

BANDAS

MARCA	MODELO	MOTOR	AÑOS	MARCA	MODELO	MOTOR	AÑOS
VOLVO	AUTOCAR	DETROIT DIESEL 6 CIL, 11.1 L DIESEL	2000-2001	MACK	CV SERIES	MACK 6 CIL, 12.0 L DIESEL	2001-2002
VOLVO	AUTOCAR	DETROIT DIESEL 6 CIL, 12.7 L DIESEL	1999-1999	MACK	CV SERIES	MACK AI DIESEL	2003-2003
VOLVO	AUTOCAR	DETROIT DIESEL 6 CIL, 12.7 L DIESEL	2000-2001	MACK	CV SERIES	MACK AMI DIESEL	2003-2004
VOLVO	WIA SERIES	DETROIT DIESEL 6 CIL, 11.1 L DIESEL	1996-1998	VOLVO	FE SERIES	VOLVO VE D7 DIESEL	1995-1995
VOLVO	WIA SERIES	DETROIT DIESEL 6 CIL, 11.1 L DIESEL	1996-1998	VOLVO	FE SERIES	VOLVO VE D7 DIESEL	1995-1995
VOLVO	WIA SERIES	DETROIT DIESEL 6 CIL, 12.7 L DIESEL	1996-1998	VOLVO	VNL	CATERPILLAR 3406 DIESEL	1997-1998
VOLVO	WIA SERIES	DETROIT DIESEL 6 CIL, 12.7 L DIESEL	1996-1998	VOLVO	XPEDITOR	CATERPILLAR 3306 DIESEL	1996-1996
VOLVO	XPEDITOR	CATERPILLAR 3306 DIESEL	1996-1996				
9490L				FREIGHTLINER	CENTURY CLASS	CATERPILLAR 3406 DIESEL	1996-1997
NISSAN	NP300	4 CIL. 2.4 L	2008-2013	KENWORTH	C500	CATERPILLAR 3176 DIESEL	1992-1994
9495				KENWORTH	T400	CATERPILLAR 3176 DIESEL	1991-1995
KENWORTH	T2000	DETROIT DIESEL 6 CIL, 11.1 L DIESEL	2000-2000	KENWORTH	T450	CATERPILLAR 3176 DIESEL	1991-1995
KENWORTH	T2000	DETROIT DIESEL 6 CIL, 12.7 L DIESEL	2000-2000	KENWORTH	T600	CATERPILLAR 3176 DIESEL	1991-1995
KENWORTH	T400	CATERPILLAR 3306 DIESEL	1991-1992	KENWORTH	T800	CATERPILLAR 3176 DIESEL	1991-1995
KENWORTH	T450	CATERPILLAR 3306 DIESEL	1991-1996	MACK	CH SERIES	MACK 6 CIL, 12.0 L DIESEL	2001-2002
STERLING	L-LINE	DETROIT DIESEL 6 CIL, 12.7 L DIESEL	2003-2003	9510			
STERLING	L-LINE	DETROIT DIESEL 6 CIL, 14.0 L DIESEL	2003-2003	FREIGHTLINER	CENTURY CLASS	DETROIT DIESEL 6 CIL, 11.1 L DIESEL	1998-1999
9500				FREIGHTLINER	CENTURY CLASS	DETROIT DIESEL 6 CIL, 11.1 L DIESEL	1997-1999
FREIGHTLINER	CENTURY CLASS	DETROIT DIESEL 6 CIL, 11.1 L DIESEL	1997-2003	FREIGHTLINER	CENTURY CLASS	DETROIT DIESEL 6 CIL, 12.7 L DIESEL	1998-1999
FREIGHTLINER	CENTURY CLASS	DETROIT DIESEL 6 CIL, 12.7 L DIESEL	1997-2003	FREIGHTLINER	CENTURY CLASS	DETROIT DIESEL 6 CIL, 12.7 L DIESEL	1997-1999
FREIGHTLINER	CENTURY CLASS	DETROIT DIESEL 6 CIL, 14.0 L DIESEL	2003-2003	FREIGHTLINER	CENTURY CLASS	MERCEDES-BENZ MBE 4000 DIESEL	2001-2001
FREIGHTLINER	COLUMBIA	DETROIT DIESEL 6 CIL, 11.1 L DIESEL	2000-2001	FREIGHTLINER	FLC	CATERPILLAR 3176 DIESEL	1994-1996
FREIGHTLINER	COLUMBIA	DETROIT DIESEL 6 CIL, 12.7 L DIESEL	2000-2003	FREIGHTLINER	FLC	CATERPILLAR 3176 DIESEL	1991-1993
FREIGHTLINER	COLUMBIA	DETROIT DIESEL 6 CIL, 14.0 L DIESEL	2002-2003	FREIGHTLINER	FLC	CATERPILLAR 3406 DIESEL	1991-1993
FREIGHTLINER	FL112	CATERPILLAR C10 DIESEL	2000-2000	FREIGHTLINER	FLC	CUMMINS L10 DIESEL	1991-1993
FREIGHTLINER	FL112	CATERPILLAR C12 DIESEL	2000-2000	FREIGHTLINER	FLC	DETROIT DIESEL 6 CIL, 11.1 L DIESEL	1997-1998
FREIGHTLINER	FLC	CATERPILLAR 3176 DIESEL	1994-1996	FREIGHTLINER	FLC	DETROIT DIESEL 6 CIL, 12.7 L DIESEL	1996-1998
FREIGHTLINER	FLC	CATERPILLAR 3176 DIESEL	1991-1993	FREIGHTLINER	FLD	CATERPILLAR 3176 DIESEL	1993-1996
FREIGHTLINER	FLC	DETROIT DIESEL 6 CIL, 11.1 L DIESEL	1997-1998	FREIGHTLINER	FLD	CATERPILLAR 3176 DIESEL	1991-1992
FREIGHTLINER	FLC	DETROIT DIESEL 6 CIL, 12.7 L DIESEL	1996-1998	FREIGHTLINER	FLD	CUMMINS L10 DIESEL	1993-1993
FREIGHTLINER	FLD	CATERPILLAR 3176 DIESEL	1994-1996	FREIGHTLINER	FLD	CUMMINS L10 DIESEL	1991-1992
FREIGHTLINER	FLD	CATERPILLAR 3176 DIESEL	1991-1993	FREIGHTLINER	FLD	DETROIT DIESEL 6 CIL, 11.1 L DIESEL	2000-2000
FREIGHTLINER	FLD	CATERPILLAR C10 DIESEL	2001-2002	FREIGHTLINER	FLD	DETROIT DIESEL 6 CIL, 11.1 L DIESEL	1994-1994
FREIGHTLINER	FLD	CATERPILLAR C12 DIESEL	2001-2002	FREIGHTLINER	FLD	DETROIT DIESEL 6 CIL, 11.1 L DIESEL	1991-1998
KENWORTH	C500	DETROIT DIESEL 6 CIL, 11.1 L DIESEL	1991-1994	FREIGHTLINER	FLD	DETROIT DIESEL 6 CIL, 12.7 L DIESEL	2000-2000
KENWORTH	C500	DETROIT DIESEL 6 CIL, 12.7 L DIESEL	1991-1994	FREIGHTLINER	FLD	DETROIT DIESEL 6 CIL, 12.7 L DIESEL	1994-1994
KENWORTH	T600	DETROIT DIESEL 6 CIL, 11.1 L DIESEL	1991-1994	FREIGHTLINER	FLD	DETROIT DIESEL 6 CIL, 12.7 L DIESEL	1991-1998
KENWORTH	T600	DETROIT DIESEL 6 CIL, 12.7 L DIESEL	1991-1994	KENWORTH	T600	CATERPILLAR C10 DIESEL	2002-2004
KENWORTH	T800	CATERPILLAR C10 DIESEL	2004-2004	KENWORTH	T600	CATERPILLAR C12 DIESEL	2002-2004
KENWORTH	T800	CATERPILLAR C10 DIESEL	2003-2003	KENWORTH	W900	DETROIT DIESEL 6 CIL, 11.1 L DIESEL	1991-1993
KENWORTH	T800	CATERPILLAR C12 DIESEL	2004-2004	KENWORTH	W900	DETROIT DIESEL 6 CIL, 12.7 L DIESEL	1991-1993
KENWORTH	T800	CATERPILLAR C12 DIESEL	2003-2003	VOLVO	VNL	CATERPILLAR 3406 DIESEL	1999-1999
KENWORTH	T800	DETROIT DIESEL 6 CIL, 11.1 L DIESEL	1991-1994	9520			
KENWORTH	T800	DETROIT DIESEL 6 CIL, 12.7 L DIESEL	1991-1994	FREIGHTLINER	FLD	DETROIT DIESEL 6 CIL, 11.1 L DIESEL	1996-1996
MACK	CS SERIES	MACK AC DIESEL	2003-2003	FREIGHTLINER	FLD	DETROIT DIESEL 6 CIL, 12.7 L DIESEL	1996-1996



MASTER SERVICIO PESADO 2014

BANDAS

MARCA	MODELO	MOTOR	AÑOS	MARCA	MODELO	MOTOR	AÑOS
KENWORTH	C500	CATERPILLAR C15 DIESEL	2000-2003				
KENWORTH	C500	CATERPILLAR C16 DIESEL	2000-2000	FORD	F-600	FORD V8, 7.0 L	1991-1994
KENWORTH	C500	DETROIT DIESEL 6 CIL, 11.1 L DIESEL	1991-1994	FREIGHTLINER	CENTURY CLASS	CATERPILLAR C10 DIESEL	1996-1997
KENWORTH	C500	DETROIT DIESEL 6 CIL, 12.7 L DIESEL	1991-1994	FREIGHTLINER	CENTURY CLASS	CATERPILLAR C12 DIESEL	1997-1997
KENWORTH	T2000	CATERPILLAR C10 DIESEL	1998-1999	FREIGHTLINER	FLC	CUMMINS L10 DIESEL	1993-1993
KENWORTH	T2000	CATERPILLAR C12 DIESEL	1998-1999	FREIGHTLINER	FLC	CUMMINS L10 DIESEL	1991-1992
KENWORTH	T600	CATERPILLAR 3406 DIESEL	1991-1995	FREIGHTLINER	FLD	CATERPILLAR 3306 DIESEL	1993-1994
KENWORTH	T600	DETROIT DIESEL 6 CIL, 11.1 L DIESEL	1991-1994	FREIGHTLINER	FLD	CATERPILLAR 3306 DIESEL	1991-1992
KENWORTH	T600	DETROIT DIESEL 6 CIL, 11.1 L DIESEL	1995-1999	FREIGHTLINER	FLD	CATERPILLAR C10 DIESEL	1997-1997
KENWORTH	T600	DETROIT DIESEL 6 CIL, 12.7 L DIESEL	1991-1994	FREIGHTLINER	FLD	CATERPILLAR C12 DIESEL	1996-1997
KENWORTH	T600	DETROIT DIESEL 6 CIL, 12.7 L DIESEL	1995-1999	FREIGHTLINER	FLD	CUMMINS L10 DIESEL	1993-1993
KENWORTH	T800	CATERPILLAR 3406 DIESEL	1991-1995	FREIGHTLINER	FLD	CUMMINS L10 DIESEL	1991-1992
KENWORTH	T800	DETROIT DIESEL 6 CIL, 11.1 L DIESEL	1991-1994	FREIGHTLINER	FLD	DETROIT DIESEL 6 CIL, 11.1 L DIESEL	1993-1995
KENWORTH	T800	DETROIT DIESEL 6 CIL, 11.1 L DIESEL	1995-1999	FREIGHTLINER	FLD	DETROIT DIESEL 6 CIL, 11.1 L DIESEL	1991-1992
KENWORTH	T800	DETROIT DIESEL 6 CIL, 12.7 L DIESEL	1991-1994	FREIGHTLINER	FLD	DETROIT DIESEL 6 CIL, 11.1 L DIESEL	1991-1994
KENWORTH	T800	DETROIT DIESEL 6 CIL, 12.7 L DIESEL	1995-1999	FREIGHTLINER	FLD	DETROIT DIESEL 6 CIL, 11.1 L DIESEL	1993-1997
KENWORTH	W900	CATERPILLAR C15 DIESEL	2004-2004	FREIGHTLINER	FLD	DETROIT DIESEL 6 CIL, 12.7 L DIESEL	1993-1995
KENWORTH	W900	DETROIT DIESEL 6 CIL, 11.1 L DIESEL	1994-1999	FREIGHTLINER	FLD	DETROIT DIESEL 6 CIL, 12.7 L DIESEL	1991-1992
KENWORTH	W900	DETROIT DIESEL 6 CIL, 12.7 L DIESEL	1994-1999	FREIGHTLINER	FLD	DETROIT DIESEL 6 CIL, 12.7 L DIESEL	1991-1994
				FREIGHTLINER	FLD	DETROIT DIESEL 6 CIL, 12.7 L DIESEL	1993-1997
FREIGHTLINER	CLASSIC	DETROIT DIESEL 6 CIL, 11.1 L DIESEL	2001-2002	KENWORTH	C500	CATERPILLAR 3306 DIESEL	1991-1992
FREIGHTLINER	CLASSIC	DETROIT DIESEL 6 CIL, 12.7 L DIESEL	2001-2004	KENWORTH	T400	CUMMINS L10 DIESEL	1991-1997
FREIGHTLINER	CLASSIC	DETROIT DIESEL 6 CIL, 14.0 L DIESEL	2003-2004	KENWORTH	T400	CUMMINS M11 DIESEL	1995-1997
FREIGHTLINER	CLASSIC XL	DETROIT DIESEL 6 CIL, 11.1 L DIESEL	2001-2002	KENWORTH	T450	CUMMINS L10 DIESEL	1991-1995
FREIGHTLINER	CLASSIC XL	DETROIT DIESEL 6 CIL, 12.7 L DIESEL	2001-2004	KENWORTH	T450	CUMMINS M11 DIESEL	1995-1995
FREIGHTLINER	CLASSIC XL	DETROIT DIESEL 6 CIL, 14.0 L DIESEL	2001-2004	KENWORTH	T600	CUMMINS ISM DIESEL	2001-2002
FREIGHTLINER	FLD	DETROIT DIESEL 6 CIL, 11.1 L DIESEL	2000-2002	KENWORTH	T600	CUMMINS L10 DIESEL	1991-1997
FREIGHTLINER	FLD	DETROIT DIESEL 6 CIL, 12.7 L DIESEL	2000-2004	KENWORTH	T600	CUMMINS M11 DIESEL	1995-1998
FREIGHTLINER	FLD	DETROIT DIESEL 6 CIL, 14.0 L DIESEL	2001-2004	KENWORTH	T800	CATERPILLAR 3306 DIESEL	1991-1992
FREIGHTLINER	FLD	DETROIT DIESEL SERIE 60	2004-2004	KENWORTH	T800	CUMMINS ISM DIESEL	1999-2002
INTERNATIONAL/NAVISTAR	9200	CATERPILLAR 3176 DIESEL	1995-1995	KENWORTH	T800	CUMMINS L10 DIESEL	1991-1997
INTERNATIONAL/NAVISTAR	9300	CATERPILLAR 3176 DIESEL	1995-1995	KENWORTH	T800	CUMMINS M11 DIESEL	1995-1998
KENWORTH	C500	DETROIT DIESEL 6 CIL, 11.1 L DIESEL	1991-1994	KENWORTH	W900	CATERPILLAR 3406 DIESEL	1991-1995
KENWORTH	C500	DETROIT DIESEL 6 CIL, 12.7 L DIESEL	1991-1994	KENWORTH	W900	CUMMINS ISM DIESEL	2002-2002
KENWORTH	K100	DETROIT DIESEL 6 CIL, 11.1 L DIESEL	1991-1993	VOLVO	AUTOCAR	CUMMINS ISM DIESEL	1999-1999
KENWORTH	K100	DETROIT DIESEL 6 CIL, 12.7 L DIESEL	1991-1993	VOLVO	AUTOCAR	CUMMINS ISM DIESEL	2000-2001
KENWORTH	T2000	CATERPILLAR C10 DIESEL	1997-1997	VOLVO	VNL	CUMMINS ISM DIESEL	2001-2001
KENWORTH	T2000	CATERPILLAR C12 DIESEL	1997-1997	VOLVO	WCA SERIES	CUMMINS ISM DIESEL	1998-1998
KENWORTH	T2000	DETROIT DIESEL 6 CIL, 11.1 L DIESEL	1997-1999	VOLVO	WCA SERIES	CUMMINS M11 DIESEL	1996-1997
KENWORTH	T2000	DETROIT DIESEL 6 CIL, 12.7 L DIESEL	1997-1999	VOLVO	WG SERIES	CUMMINS ISM DIESEL	1998-2001
KENWORTH	T600	DETROIT DIESEL 6 CIL, 11.1 L DIESEL	1991-1994	VOLVO	WG SERIES	CUMMINS L10 DIESEL	1996-1997
KENWORTH	T600	DETROIT DIESEL 6 CIL, 12.7 L DIESEL	1991-1994	VOLVO	WG SERIES	CUMMINS M11 DIESEL	1996-1996
KENWORTH	T800	DETROIT DIESEL 6 CIL, 11.1 L DIESEL	1991-1994	VOLVO	WG SERIES	CUMMINS M11 DIESEL	1997-1997
KENWORTH	T800	DETROIT DIESEL 6 CIL, 12.7 L DIESEL	1991-1994	VOLVO	WIA SERIES	CATERPILLAR 3406 DIESEL	1997-1998
VOLVO	WIA SERIES	CATERPILLAR 3406 DIESEL	1996-1996	VOLVO	WIA SERIES	CUMMINS ISM DIESEL	1998-1999



MASTER SERVICIO PESADO 2014

BANDAS

MARCA	MODELO	MOTOR	AÑOS	MARCA	MODELO	MOTOR	AÑOS
VOLVO	WIA SERIES	CUMMINS L10 DIESEL	1997-1997	KENWORTH	T800	DETROIT DIESEL 6 CIL, 11.1 L DIESEL	1991-1994
VOLVO	WIA SERIES	CUMMINS M11 DIESEL	1996-1997	KENWORTH	T800	DETROIT DIESEL 6 CIL, 12.7 L DIESEL	1991-1994
9540				KENWORTH	W900	DETROIT DIESEL 6 CIL, 11.1 L DIESEL	1991-1993
FORD	F-600	FORD V8, 6.1 L	1991-1991	KENWORTH	W900	DETROIT DIESEL 6 CIL, 12.7 L DIESEL	1991-1993
FORD	F-600	FORD V8, 7.0 L	1991-1994	9550			
FREIGHTLINER	FLC	CUMMINS N14 DIESEL	1993-1996	FORD	F-600	FORD 6 CIL, 6.6 L DIESEL	1991-1993
FREIGHTLINER	FLC	CUMMINS N14 DIESEL	1991-1992	FREIGHTLINER	FLC	CATERPILLAR 3406 DIESEL	1991-1993
FREIGHTLINER	FLD	CUMMINS N14 DIESEL	1993-1995	FREIGHTLINER	FLD	CATERPILLAR 3306 DIESEL	1991-1992
FREIGHTLINER	FLD	CUMMINS N14 DIESEL	1991-1992	FREIGHTLINER	FLD	CATERPILLAR 3406 DIESEL	1991-1997
KENWORTH	C500	CATERPILLAR 3176 DIESEL	1992-1994	KENWORTH	K100	DETROIT DIESEL 6 CIL, 11.1 L DIESEL	1991-1993
KENWORTH	K100	CATERPILLAR 3406 DIESEL	1991-1993	KENWORTH	K100	DETROIT DIESEL 6 CIL, 12.7 L DIESEL	1991-1993
KENWORTH	T400	CATERPILLAR 3176 DIESEL	1991-1995	VOLVO	WIA SERIES	DETROIT DIESEL 6 CIL, 11.1 L DIESEL	1996-1998
KENWORTH	T450	CATERPILLAR 3176 DIESEL	1991-1995	VOLVO	WIA SERIES	DETROIT DIESEL 6 CIL, 12.7 L DIESEL	1996-1998
KENWORTH	T600	CATERPILLAR 3176 DIESEL	1991-1995	9555			
KENWORTH	T800	CATERPILLAR 3176 DIESEL	1991-1995	KENWORTH	T600	CATERPILLAR C10 DIESEL	1996-1996
KENWORTH	T800	CATERPILLAR 3306 DIESEL	1991-1992	KENWORTH	T600	CATERPILLAR C10 DIESEL	1997-2001
KENWORTH	W900	CATERPILLAR C10 DIESEL	2001-2004	KENWORTH	T600	CATERPILLAR C12 DIESEL	1996-2001
KENWORTH	W900	CATERPILLAR C12 DIESEL	2001-2001	KENWORTH	T800	CATERPILLAR C10 DIESEL	1997-1998
VOLVO	VNL	CUMMINS ISM DIESEL	1998-1998	KENWORTH	T800	CATERPILLAR C10 DIESEL	1999-2003
VOLVO	VNL	CUMMINS M11 DIESEL	1997-1997	KENWORTH	T800	CATERPILLAR C12 DIESEL	1996-1998
VOLVO	WCA SERIES	CUMMINS ISM DIESEL	1998-1998	KENWORTH	T800	CATERPILLAR C12 DIESEL	1999-2003
VOLVO	WCA SERIES	CUMMINS M11 DIESEL	1996-1997	KENWORTH	W900	CATERPILLAR 3406 DIESEL	1991-1995
VOLVO	WG SERIES	CUMMINS L10 DIESEL	1996-1997	VOLVO	AUTOCAR	DETROIT DIESEL 6 CIL, 11.1 L DIESEL	1998-1998
VOLVO	WG SERIES	CUMMINS M11 DIESEL	1996-1996	VOLVO	AUTOCAR	DETROIT DIESEL 6 CIL, 12.7 L DIESEL	1998-1998
VOLVO	WIA SERIES	CUMMINS ISM DIESEL	1998-1999	VOLVO	VNL	DETROIT DIESEL 6 CIL, 11.1 L DIESEL	1998-2001
VOLVO	WIA SERIES	CUMMINS L10 DIESEL	1997-1997	VOLVO	VNL	DETROIT DIESEL 6 CIL, 12.7 L DIESEL	1998-2001
VOLVO	WIA SERIES	CUMMINS M11 DIESEL	1996-1997	VOLVO	XPEDITOR	CUMMINS L10 DIESEL	1996-1996
9545				9560			
FORD	F-600	FORD 6 CIL, 6.6 L DIESEL	1991-1993	KENWORTH	C500	CATERPILLAR 3176 DIESEL	1992-1994
FREIGHTLINER	CENTURY CLASS	CUMMINS ISM DIESEL	1998-1998	KENWORTH	T2000	CATERPILLAR C15 DIESEL	2000-2001
FREIGHTLINER	CENTURY CLASS	CUMMINS M11 DIESEL	1996-1997	KENWORTH	T2000	CATERPILLAR C16 DIESEL	2000-2001
FREIGHTLINER	FL112	CUMMINS ISM DIESEL	1998-1998	KENWORTH	T400	CATERPILLAR 3176 DIESEL	1991-1995
FREIGHTLINER	FL112	CUMMINS M11 DIESEL	1996-1997	KENWORTH	T400	CUMMINS L10 DIESEL	1991-1997
FREIGHTLINER	FLC	CUMMINS L10 DIESEL	1993-1993	KENWORTH	T450	CATERPILLAR 3176 DIESEL	1991-1995
FREIGHTLINER	FLC	CUMMINS L10 DIESEL	1991-1992	KENWORTH	T450	CUMMINS L10 DIESEL	1991-1995
FREIGHTLINER	FLC	CUMMINS M11 DIESEL	1995-1997	KENWORTH	T600	CATERPILLAR 3176 DIESEL	1991-1995
FREIGHTLINER	FLD	CUMMINS ISM DIESEL	1998-1998	KENWORTH	T600	CUMMINS L10 DIESEL	1991-1997
FREIGHTLINER	FLD	CUMMINS L10 DIESEL	1993-1993	KENWORTH	T800	CATERPILLAR 3176 DIESEL	1991-1995
FREIGHTLINER	FLD	CUMMINS L10 DIESEL	1991-1992	KENWORTH	T800	CUMMINS L10 DIESEL	1991-1997
FREIGHTLINER	FLD	CUMMINS M11 DIESEL	1995-1997	KENWORTH	W900	CATERPILLAR 3406 DIESEL	1990-1996
FREIGHTLINER	FLD	CUMMINS N14 DIESEL	1996-1996	VOLVO	WG SERIES	CATERPILLAR 3306 DIESEL	1996-1996
KENWORTH	C500	DETROIT DIESEL 6 CIL, 11.1 L DIESEL	1991-1994	9565			
KENWORTH	C500	DETROIT DIESEL 6 CIL, 12.7 L DIESEL	1991-1994	FORD	F-600	FORD 6 CIL, 6.6 L DIESEL	1991-1993
KENWORTH	T600	DETROIT DIESEL 6 CIL, 11.1 L DIESEL	1991-1994	9570			
KENWORTH	T600	DETROIT DIESEL 6 CIL, 12.7 L DIESEL	1991-1994	FREIGHTLINER	FLC	CATERPILLAR 3406 DIESEL	1990-1993



MASTER SERVICIO PESADO 2014

BANDAS

MARCA	MODELO	MOTOR	AÑOS	MARCA	MODELO	MOTOR	AÑOS
KENWORTH	K100	CATERPILLAR 3406 DIESEL	1990-1991	KENWORTH	T600	DETROIT DIESEL 6 CIL, 12.7 L DIESEL	1995-1996
KENWORTH	T400	CATERPILLAR 3306 DIESEL	1990-1992	KENWORTH	T800	CATERPILLAR 3406 DIESEL	1990-1998
KENWORTH	T450	CATERPILLAR 3306 DIESEL	1990-1996	KENWORTH	T800	DETROIT DIESEL 6 CIL, 11.1 L DIESEL	1995-1996
VOLVO	WG SERIES	CATERPILLAR 3306 DIESEL	1996-1997	KENWORTH	T800	DETROIT DIESEL 6 CIL, 12.7 L DIESEL	1995-1996
9580				KENWORTH	W900	CATERPILLAR 3406 DIESEL	1990-1996
FORD	F-600	FORD V8, 6.1 L	1991-1991	KENWORTH	W900	CATERPILLAR 3406 DIESEL	1999-2000
FORD	F-600	FORD V8, 7.0 L	1991-1994	KENWORTH	W900	CATERPILLAR C10 DIESEL	1997-2000
KENWORTH	T600	CATERPILLAR 3406 DIESEL	1991-1996	KENWORTH	W900	CATERPILLAR C12 DIESEL	2000-2000
KENWORTH	T800	CATERPILLAR 3406 DIESEL	1991-1996	KENWORTH	W900	CATERPILLAR C15 DIESEL	2000-2003
KENWORTH	W900	CATERPILLAR 3406 DIESEL	1991-1996	KENWORTH	W900	CATERPILLAR C16 DIESEL	2000-2003
VOLVO	WIA SERIES	DETROIT DIESEL 6 CIL, 11.1 L DIESEL	1996-1998	VOLVO	WG SERIES	CATERPILLAR 3306 DIESEL	1997-1997
VOLVO	WIA SERIES	DETROIT DIESEL 6 CIL, 12.7 L DIESEL	1996-1998	VOLVO	WG SERIES	CATERPILLAR 3306 DIESEL	1996-1996
9585				VOLVO	XPEDITOR	VOLVO VE D7 DIESEL	1999-2000
STERLING	L-LINE	CATERPILLAR 3306 DIESEL	2000-2000	9620			
9590				FREIGHTLINER	FLD	CATERPILLAR 3406 DIESEL	1990-1997
FORD	F-600	FORD 6 CIL, 6.6 L DIESEL	1991-1993	FREIGHTLINER	FLD	CATERPILLAR 3406 DIESEL	1996-1996
FORD	F-600	FORD 6 CIL, 7.8 L DIESEL	1991-1993	ISUZU	ELF 450	4HK1-TC	2006-2008
FREIGHTLINER	ARGOSY	DETROIT DIESEL 6 CIL, 11.1 L DIESEL	1999-1999	KENWORTH	T600	CATERPILLAR 3406 DIESEL	1990-1996
FREIGHTLINER	ARGOSY	DETROIT DIESEL 6 CIL, 12.7 L DIESEL	1999-1999	KENWORTH	T600	CATERPILLAR C15 DIESEL	2000-2004
KENWORTH	C500	DETROIT DIESEL 6 CIL, 11.1 L DIESEL	1991-1994	KENWORTH	T800	CATERPILLAR 3406 DIESEL	1990-1996
KENWORTH	C500	DETROIT DIESEL 6 CIL, 12.7 L DIESEL	1991-1994	KENWORTH	T800	CATERPILLAR 3406 DIESEL	1999-2000
KENWORTH	T600	DETROIT DIESEL 6 CIL, 11.1 L DIESEL	1991-1994	KENWORTH	T800	CATERPILLAR C15 DIESEL	2000-2004
KENWORTH	T600	DETROIT DIESEL 6 CIL, 12.7 L DIESEL	1991-1994	KENWORTH	T800	CATERPILLAR C16 DIESEL	2000-2003
KENWORTH	T800	DETROIT DIESEL 6 CIL, 11.1 L DIESEL	1991-1994	KENWORTH	W900	CATERPILLAR 3406 DIESEL	1990-1996
KENWORTH	T800	DETROIT DIESEL 6 CIL, 12.7 L DIESEL	1991-1994	9625			
KENWORTH	W900	CATERPILLAR 3406 DIESEL	1990-1999	FORD	F-600	FORD 6 CIL, 6.6 L DIESEL	1991-1993
KENWORTH	W900	DETROIT DIESEL 6 CIL, 11.1 L DIESEL	1991-1993	FREIGHTLINER	FLD	CATERPILLAR 3406 DIESEL	1994-1994
KENWORTH	W900	DETROIT DIESEL 6 CIL, 12.7 L DIESEL	1991-1993	KENWORTH	W900	CATERPILLAR 3406 DIESEL	1990-1990
9600				VOLVO	AUTOCAR	DETROIT DIESEL 6 CIL, 11.1 L DIESEL	1999-1999
FREIGHTLINER	ARGOSY	DETROIT DIESEL 6 CIL, 11.1 L DIESEL	1999-1999	VOLVO	AUTOCAR	DETROIT DIESEL 6 CIL, 11.1 L DIESEL	2000-2001
FREIGHTLINER	ARGOSY	DETROIT DIESEL 6 CIL, 12.7 L DIESEL	1999-1999	VOLVO	AUTOCAR	DETROIT DIESEL 6 CIL, 12.7 L DIESEL	1999-1999
FREIGHTLINER	CENTURY CLASS	CATERPILLAR 3406 DIESEL	1996-1997	VOLVO	AUTOCAR	DETROIT DIESEL 6 CIL, 12.7 L DIESEL	2000-2001
FREIGHTLINER	FLD	CATERPILLAR 3406 DIESEL	1991-1997	VOLVO	XPEDITOR	VOLVO VE D7 DIESEL	1999-1999
9605				9630			
KENWORTH	T600	CATERPILLAR 3406 DIESEL	1991-1996	FORD	F-600	FORD 6 CIL, 6.6 L DIESEL	1991-1993
KENWORTH	T800	CATERPILLAR 3406 DIESEL	1991-1995	FORD	F-600	FORD 6 CIL, 6.6 L DIESEL	1991-1993
KENWORTH	W900	CATERPILLAR 3406 DIESEL	1991-1996	FORD	F-600	FORD 6 CIL, 7.8 L DIESEL	1991-1993
9610				9635			
FORD	F-600	FORD 6 CIL, 6.6 L DIESEL	1991-1993	FREIGHTLINER	FLD	CATERPILLAR 3306 DIESEL	1993-1994
FORD	F-600	FORD V8, 6.1 L	1991-1991	9640			
FORD	F-600	FORD V8, 7.0 L	1991-1994	CHEVROLET	C5500	GM V8 7.4 L	1999-2000
FREIGHTLINER	FLD	DETROIT DIESEL 6 CIL, 11.1 L DIESEL	1991-1999	CHEVROLET	C6500	GM V8 7.4 L	1999-2000
FREIGHTLINER	FLD	DETROIT DIESEL 6 CIL, 12.7 L DIESEL	1991-1999	CHEVROLET	C7500	GM V8 7.4 L	1999-2000
KENWORTH	T600	CATERPILLAR 3406 DIESEL	1990-1999	CHEVROLET	C8500	GM V8 7.4 L	1999-2000
KENWORTH	T600	DETROIT DIESEL 6 CIL, 11.1 L DIESEL	1995-1996	FORD	F-600	CUMMINS C Series 8.3 L DIESEL	1993-1994



MASTER SERVICIO PESADO 2014

BANDAS

MARCA	MODELO	MOTOR	AÑOS	MARCA	MODELO	MOTOR	AÑOS
FORD	F-600	FORD 6 CIL, 6.6 L DIESEL	1991-1991			9710	
KENWORTH	T2000	CATERPILLAR 3406 DIESEL	1997-1999	FORD	F-600	FORD 6 CIL, 7.8 L DIESEL	1991-1993
		9650		FORD	F-600	FORD 6 CIL, 7.8 L DIESEL	1993-1993
CHEVROLET	C5500	GM V8 6.0 L	1997-1998			9775	
CHEVROLET	C5500	GM V8 7.0 L	1997-1998	STERLING	L-LINE	CUMMINS ISB DIESEL	2000-2000
CHEVROLET	C6500	GM V8 6.0 L	1997-1998			A38	
CHEVROLET	C6500	GM V8 7.0 L	1997-1998	HINO	414 SERIE 300	HINO N04C-TUV	2010-2011
CHEVROLET	C7500	GM V8 6.0 L	1997-1998	HINO	514 SERIE 300	HINO N04C-UV	2012-2013
CHEVROLET	C7500	GM V8 7.0 L	1997-1998	HINO	616 SERIE 300	HINO N04C-TT	2007-2008
CHEVROLET	C8500	GM V8 6.0 L	1997-1998	HINO	616 SERIE 300	HINO N04C-TUV	2009-2011
CHEVROLET	C8500	GM V8 7.0 L	1997-1998	HINO	616 SERIE 300	HINO N04C-UV	2012-2013
FORD	F-600	FORD 6 CIL, 6.6 L DIESEL	1991-1993	HINO	716 SERIE 300	HINO N04C-TT	2007-2008
FORD	F-600	FORD 6 CIL, 7.8 L DIESEL	1991-1993	HINO	716 SERIE 300	HINO N04C-TUV	2009-2011
FORD	F-600	FORD 6 CIL, 7.8 L DIESEL	1991-1991	HINO	716 SERIE 300	HINO N04C-UV	2012-2013
FORD	F-600	FORD V8, 6.1 L	1991-1991	HINO	816 SERIE 300	HINO N04C-TT	2007-2008
FORD	F-600	FORD V8, 7.0 L	1991-1994	HINO	816 SERIE 300	HINO N04C-TUV	2009-2011
KENWORTH	T2000	CATERPILLAR 3406 DIESEL	2000-2000	HINO	816 SERIE 300	HINO N04C-UV	2012-2013
KENWORTH	T2000	CATERPILLAR C15 DIESEL	2002-2003			A44	
KENWORTH	T2000	CATERPILLAR C16 DIESEL	2002-2003	MERCEDES BENZ	MARCOPOLO ANDARE	MERCEDES-BENZ 960	2001-2001
KENWORTH	T600	CATERPILLAR 3406 DIESEL	1991-1996			A48	
KENWORTH	T600	CATERPILLAR 3406 DIESEL	1990-1990	HINO	414 SERIE 300	HINO N04C-TUV	2010-2011
KENWORTH	T800	CATERPILLAR 3406 DIESEL	1991-1996	HINO	514 SERIE 300	HINO N04C-UV	2012-2013
KENWORTH	W900	CATERPILLAR 3406 DIESEL	1990-1996	HINO	616 SERIE 300	HINO N04C-TT	2007-2008
		9670		HINO	616 SERIE 300	HINO N04C-TUV	2009-2011
KENWORTH	T600	CATERPILLAR 3406 DIESEL	1990-1990	HINO	616 SERIE 300	HINO N04C-UV	2012-2013
		9680		HINO	716 SERIE 300	HINO N04C-TT	2007-2008
CHEVROLET	C5500	GM V8 7.4 L	1999-2000	HINO	716 SERIE 300	HINO N04C-TUV	2009-2011
CHEVROLET	C6500	GM V8 7.4 L	1999-2000	HINO	716 SERIE 300	HINO N04C-UV	2012-2013
CHEVROLET	C7500	GM V8 7.4 L	1999-2000	HINO	816 SERIE 300	HINO N04C-TT	2007-2008
CHEVROLET	C8500	GM V8 7.4 L	1999-2000	HINO	816 SERIE 300	HINO N04C-TUV	2009-2011
		9690		HINO	816 SERIE 300	HINO N04C-UV	2012-2013
CHEVROLET	C5500	GM V8 6.0 L	1997-1998			AX36	
CHEVROLET	C5500	GM V8 7.0 L	1997-1998	VOLVO	7550	7550	2001-2006
CHEVROLET	C6500	GM V8 6.0 L	1997-1998	VOLVO	7550 FL	B12	2005-2008
CHEVROLET	C6500	GM V8 7.0 L	1997-1998	VOLVO	9700	B12	2002-2006
CHEVROLET	C7500	GM V8 6.0 L	1997-1998			AX37	
CHEVROLET	C7500	GM V8 7.0 L	1997-1998	IRIZAR	MAN R-33	MAN R-33	2006-2010
CHEVROLET	C8500	GM V8 6.0 L	1997-1998			AX39	
CHEVROLET	C8500	GM V8 7.0 L	1997-1998	DINA	LINNER	CUMMINS ISB 6.7 L	2009-2014
DINA	S-600	INTERNATIONAL/NAVISTAR DT466	1990-1997	NISSAN	NP300	4 CIL. 2.5 L DIESEL	2008-2013
FORD	F-600	FORD 6 CIL, 6.6 L DIESEL	1991-1993			AX41	
MERCEDES BENZ	0371 RS	OM 355	1990-1998	DINA	OUTSIDER	CUMMINS ISB 6.7 L	2009-2014
MERCEDES BENZ	AUTOBUS INTEGRAL	OM 355 LA	1991-1991	MERCEDES BENZ	BUSSCAR	MB 906	2002-2008
		9700				AX42	
DINA	S-500	INTERNATIONAL/NAVISTAR DT466 DIESEL	1990-1997	IRIZAR	INTERCENTURY	906	2003-2006



MASTER SERVICIO PESADO 2014

BANDAS

MARCA	MODELO	MOTOR	AÑOS	MARCA	MODELO	MOTOR	AÑOS
MERCEDES BENZ	BUSS 320	BUSS 320	2002-2006			AX72	
MERCEDES BENZ	CENTURY CLASS	CENTURY CLASS	2006-2010	SCANIA	SCANIA	DSC11-22	1992-1998
MERCEDES BENZ	MULTEGO	MULTEGO	2002-2009	SCANIA	SCANIA	K113	1994-2000
MERCEDES BENZ	TURICLASS	O-500-1841	2007-2010	SCANIA	SCANIA PARADISO	K112	1992-2000
		AX43				AX85	
GIANT MOTORS	GF-3600	GIANT SUPER DIESEL CA4C32-10E3	2007-2008	VOLVO	7550	7550	2001-2006
		AX44				AX86	
MERCEDES BENZ	ALEGRO	MB 1623	2004-2010	VOLVO	7550 FL	B12	2005-2008
MERCEDES BENZ	MARCOPOLO ANDARE	MB 1628	2000-2005	VOLVO	9700	B12	2002-2006
MERCEDES BENZ	TORINO	MB 906	2005-2010			BX37	
		AX46		DINA	LINNER	CUMMINS ISB 6.7 L	2009-2014
GIANT MOTORS	GF-3600	GIANT SUPER DIESEL CA4C32-10E3	2007-2008	DINA	OUTSIDER	CUMMINS ISB 6.7 L	2009-2014
		AX47				BX50	
MERCEDES BENZ	ALBATROS	MB 447	2000-2006	FREIGHTLINER	FLD120	DETROIT DIESEL SERIE 60	2001-2001
		AX50				BX52	
VOLVO	C11R URBANO	CUMMINS ISB DIESEL	2004-2004	DINA	102 F	CUMMINS ISB	2008-2009
		AX54		DINA	104-R	CUMMINS ISB	2008-2009
IRIZAR	INTERCENTURY	906	2003-2003	DINA	104-SF	CUMMINS ISB	2008-2009
IRIZAR	INTERCENTURY	906	2004-2006	DINA	94 F	CUMMINS ISB	2008-2008
		AX55				BX53	
VOLVO	C11R URBANO	CUMMINS ISB DIESEL	2004-2004	DINA	102 F	CUMMINS ISB	2008-2009
		AX57		DINA	104-R	CUMMINS ISB	2008-2009
MERCEDES BENZ	ALBATROS	MB 447	2000-2006	DINA	104-SF	CUMMINS ISB	2008-2009
		AX65		DINA	94 F	CUMMINS ISB	2008-2008
IRIZAR	INTERCENTURY	906	2003-2006	DINA	LINNER	CUMMINS ISB 6.7 L	2009-2014
		AX67		DINA	LINNER	CUMMINS ISB 6.7 L	2009-2014
MERCEDES BENZ	0371 RS	OM 447	1990-1998			BX54	
MERCEDES BENZ	ALBATROS	MB 447	2000-2005	DINA	OUTSIDER	CUMMINS ISB 6.7 L	2009-2014
MERCEDES BENZ	ALBATROS	MB 447	2006-2006	KENWORTH	T600	CATERPILLAR 3406 DIESEL	1990-1990
MERCEDES BENZ	ALBATROS	MB 447	2000-2006			BX55	
MERCEDES BENZ	AUTOBUS INTEGRAL	OM 447 LA	1992-1992	DINA	OUTSIDER	CUMMINS ISB 6.7 L	2009-2014
MERCEDES BENZ	AUTOBUS INTEGRAL	OM 449 LA	1993-1996	DODGE	RAM-6500	V8, 5.9 L	1995-1995
		AX68				BX56	
MERCEDES BENZ	ALEGRO	MB 1623	2004-2010	KENWORTH	W900	CATERPILLAR 3406 DIESEL	1990-1990
MERCEDES BENZ	BUSSCAR	MB 906	2002-2008			BX62	
MERCEDES BENZ	MARCOPOLO ANDARE	MB 1628	2000-2005	DINA	OUTSIDER	CUMMINS ISB 6.7 L	2009-2014
MERCEDES BENZ	MARCOPOLO ANDARE	MERCEDES-BENZ 960	2001-2001			BX66	
MERCEDES BENZ	TORINO	MB 906	2005-2010	MERCEDES BENZ	AUTOBUS INTEGRAL	OM 447 LA	1998-1998
		AX69				BX68	
DINA	CITUS	INTERNATIONAL/NAVISTAR DT466	1992-1998	MERCEDES BENZ	MULTEGO	MULTEGO	2002-2009
DINA	S-400	INTERNATIONAL/NAVISTAR DT360 DIESEL	1990-1997			BX73	
DINA	S-500	INTERNATIONAL/NAVISTAR DT360 DIESEL	1990-1997	DINA	S-600	INTERNATIONAL/NAVISTAR DT466	1990-1997
DODGE	D-600	DODGE V8, 5.9 L	1990-1994			BX75	
		AX70		IRIZAR	MAN R-33	MAN R-33	2006-2010
DINA	CITUS	INTERNATIONAL/NAVISTAR DT466	1992-1998				



MASTER SERVICIO PESADO 2014

BANDAS

MARCA	MODELO	MOTOR	AÑOS
BX76			
NEOPLAN	NEOPLAN 2 PISOS	CUMMINS S60	1992-1999
NEOPLAN	NEOPLAN 2 PISOS	CUMMINS S60	2000-2000
BX77			
DINA	S-500	INTERNATIONAL/NAVISTAR DT466 DIESEL	1990-1997
BX80			
NEOPLAN	NEOPLAN 2 PISOS	CUMMINS S60	1992-2000
BX82			
NEOPLAN	NEOBUS	CUMMINS S60	2000-2006
BX83			
IRIZAR	INTERCENTURY	906	2003-2006
MASA	PREMIER	DETROIT DIESEL SERIE 60	1993-1996
BX87			
SCANIA	IRIZAR I5	K420	2012-2013
SCANIA	IRIZAR I6	K420	2013-2013
BX88			
DINA	AVANTE	DETROIT DIESEL V8	1990-1992
DINA	DORADO	DETROIT DIESEL SERIE 60, 12.7 L	1992-1996
MERCEDES BENZ	ALBATROS	MB 447	2000-2006
VOLVO	7550	7550	2001-2006
BX89			
MASA	ESTRADA	DETROIT DIESEL SERIE 50	1997-2000
BX90			
DINA	AVANTE	DETROIT DIESEL V6	1990-1992
DINA	F-11	DETROIT DIESEL SERIE 50	1997-1999
DINA	MARCOPOLO PARADISO	DETROIT DIESEL SERIE 60, 12.7 L	1992-1997
DINA	MARCOPOLO VIAGGIO GV1000	DETROIT DIESEL SERIE 60, 12.7 L	1994-1998
MASA	PREMIER	DETROIT DIESEL V6	1993-1996
MERCEDES BENZ	0371 RS	OM 447	1990-1998
MERCEDES BENZ	CENTURY CLASS	CENTURY CLASS	2006-2010
SCANIA	SCANIA	K113	1994-2000
BX91			
DINA	MARCOPOLO GV850	CATERPILLAR C10 DIESEL	1992-1998
BX92			
DINA	MARCOPOLO GV850	CATERPILLAR C10 DIESEL	1992-1998
MASA	ESTRADA	DETROIT DIESEL SERIE 50	1997-2000
MASA	ESTRADA	DETROIT DIESEL SERIE 60	1997-2000
VOLVO	7550 FL	B12	2005-2008
VOLVO	9700	B12	2002-2006
BX93			
DINA	AVANTE	DETROIT DIESEL V8	1990-1992
MASA	ESTRADA	DETROIT DIESEL SERIE 50	1997-2000
MERCEDES BENZ	BUSSCAR	MB 906	2002-2008
SCANIA	SCANIA	DSC11-22	1992-1998
BX94			

MARCA	MODELO	MOTOR	AÑOS
DINA	AVANTE	DETROIT DIESEL V6	1990-1992
NEOPLAN	NEOBUS	CUMMINS S60	2000-2006
SCANIA	SCANIA PARADISO	K112	1992-2000
VOLVO	9700 FL	B12	2005-2011
BX96			
VOLVO	9300	B9	2004-2004
BX97			
DINA	MARCOPOLO PARADISO	DETROIT DIESEL SERIE 60, 12.7 L	1992-1997
DINA	MARCOPOLO VIAGGIO GV1000	DETROIT DIESEL SERIE 60, 12.7 L	1994-1998
NEOPLAN	NEOBUS	CUMMINS S60	2000-2006
NEOPLAN	NEOPLAN 2 PISOS	CUMMINS S60	1992-2000
BX99			
DINA	DORADO	DETROIT DIESEL SERIE 60, 12.7 L	1992-1996
CADENA			
CHEVROLET	S-10	4 CIL. 2.2 L	1994-2003
FORD	COURIER	4 CIL. 1.6 L	2003-2009
NISSAN	CHASIS	4 CIL. 2.4 L	1995-2006
NISSAN	ESTAQUITAS	4 CIL. 1.8 L	1993-1994
NISSAN	ESTAQUITAS	4 CIL. 2.4 L	1995-2004
NISSAN	PICK-UP	4 CIL. 2.4 L	1993-2004
NISSAN	URVAN	4 CIL. 2.4 L	2000-2008
VOLKSWAGEN	EUROVAN	6 CIL. 2.8 L	2004-2004
DK070551			
VOLKSWAGEN	EUROVAN	6 CIL. 2.8 L	2004-2004
DK081254			
FORD	F-450 SUPER DUTY	V8, 6.7 L DIESEL	2011-2013
FORD	F-450 SUPER DUTY	V8, 6.7 L DIESEL	2011-2012
FORD	F-550 SUPER DUTY	V8, 6.7 L DIESEL	2011-2013
DK081403			
FORD	F-450 SUPER DUTY	V8, 6.7 L DIESEL	2011-2013
FORD	F-450 SUPER DUTY	V8, 6.7 L DIESEL	2011-2012
FORD	F-550 SUPER DUTY	V8, 6.7 L DIESEL	2011-2013
K040325			
NISSAN	CABSTAR	NISSAN DIESEL YD25DDTi	2008-2013
K040354			
NISSAN	URVAN	4 CIL. 2.4 L	2000-2008
K040360			
NISSAN	URVAN	4 CIL. 2.4 L	2000-2004
NISSAN	URVAN	4 CIL. 2.4 L	2005-2008
K040370			
HYUNDAI	H100	4 CIL. 2.5 L DIESEL	2006-2014
HYUNDAI	H100 VANWAGON	4 CIL. 2.5 L DIESEL	2009-2013
K040385			
HYUNDAI	H100	4 CIL. 2.4 L	2004-2005
K040390			



MASTER SERVICIO PESADO 2014

BANDAS

MARCA	MODELO	MOTOR	AÑOS	MARCA	MODELO	MOTOR	AÑOS
HYUNDAI	VAN 1000	4 CIL, 2.4 L	2007-2012	CHEVROLET	C6500	GM V8 8.1 L	2003-2008
HYUNDAI	VAN 1000	4 CIL, 2.4 L	2007-2012	CHEVROLET	C7500	GM V8 8.1 L	2003-2008
K040415				CHEVROLET	C8500	GM V8 8.1 L	2003-2008
HYUNDAI	H100	4 CIL, 2.5 L DIESEL	2006-2014	K040762			
HYUNDAI	H100 VAN/WAGON	4 CIL, 2.5 L DIESEL	2009-2013	CHEVROLET	C5500	GM V8 8.1 L	2001-2002
K040420				CHEVROLET	C6500	GM V8 8.1 L	2001-2002
HYUNDAI	H100	4 CIL, 2.5 L DIESEL	2006-2014	CHEVROLET	C7500	GM V8 8.1 L	2001-2002
HYUNDAI	H100 VAN/WAGON	4 CIL, 2.5 L DIESEL	2009-2013	CHEVROLET	C8500	GM V8 8.1 L	2001-2002
K040425				CHEVROLET	KODIAK	GM V8, 8.1 L	2001-2008
INTERNATIONAL/NAVISTAR	8100	CUMMINS N14 DIESEL	1995-1997	K050323			
INTERNATIONAL/NAVISTAR	8200	CUMMINS N14 DIESEL	1995-1998	INTERNATIONAL/NAVISTAR	8100	CUMMINS ISM DIESEL	1999-1999
INTERNATIONAL/NAVISTAR	9300	CUMMINS N14 DIESEL	1995-1995	INTERNATIONAL/NAVISTAR	8100	CUMMINS L10 DIESEL	1997-1997
INTERNATIONAL/NAVISTAR	9400	CUMMINS N14 DIESEL	1995-1995	K050336			
INTERNATIONAL/NAVISTAR	9400	CUMMINS NTC 400	1990-1990	INTERNATIONAL/NAVISTAR	5000	CUMMINS ISM DIESEL	1998-1998
INTERNATIONAL/NAVISTAR	9600	CUMMINS N14 DIESEL	1996-1996	INTERNATIONAL/NAVISTAR	5000	CUMMINS ISM DIESEL	1999-2000
INTERNATIONAL/NAVISTAR	9700	CUMMINS N14 DIESEL	1996-1996	INTERNATIONAL/NAVISTAR	5000	CUMMINS L10 DIESEL	1990-1998
KENWORTH	W900	CUMMINS NTC 300	1990-1990	INTERNATIONAL/NAVISTAR	5000	CUMMINS M11 DIESEL	1996-1998
K040430				INTERNATIONAL/NAVISTAR	5000	CUMMINS M11 DIESEL	1999-2000
FREIGHTLINER	FLC	CUMMINS N14 DIESEL	1991-1996	INTERNATIONAL/NAVISTAR	5500I	CUMMINS ISM DIESEL	2000-2000
FREIGHTLINER	FLD	CUMMINS N14 DIESEL	1991-1996	INTERNATIONAL/NAVISTAR	5600I	CUMMINS ISM DIESEL	2000-2000
INTERNATIONAL/NAVISTAR	5000	CUMMINS N14 DIESEL	1992-1993	INTERNATIONAL/NAVISTAR	5900I	CUMMINS ISM DIESEL	2000-2000
INTERNATIONAL/NAVISTAR	9200	CUMMINS N14 DIESEL	1996-1996	INTERNATIONAL/NAVISTAR	8100	CUMMINS ISM DIESEL	1998-1999
INTERNATIONAL/NAVISTAR	9300	CUMMINS N14 DIESEL	1995-1995	INTERNATIONAL/NAVISTAR	8100	CUMMINS ISM DIESEL	1999-2003
INTERNATIONAL/NAVISTAR	9400	CUMMINS N14 DIESEL	1995-1995	INTERNATIONAL/NAVISTAR	8100	CUMMINS L10 DIESEL	1995-1996
INTERNATIONAL/NAVISTAR	PAYSTAR	CUMMINS N14 DIESEL	1992-1993	INTERNATIONAL/NAVISTAR	8100	CUMMINS M11 DIESEL	1995-1997
KENWORTH	K100	CUMMINS 6 CIL, 14.0 L DIESEL	1991-1991	INTERNATIONAL/NAVISTAR	8200	CUMMINS ISM DIESEL	1998-1998
KENWORTH	K100	CUMMINS N14 DIESEL	1992-1993	INTERNATIONAL/NAVISTAR	8200	CUMMINS L10 DIESEL	1995-1997
KENWORTH	T600	CUMMINS 6 CIL, 14.0 L DIESEL	1991-1991	INTERNATIONAL/NAVISTAR	8200	CUMMINS M11 DIESEL	1995-1997
KENWORTH	T600	CUMMINS N14 DIESEL	1992-1996	INTERNATIONAL/NAVISTAR	9100	CUMMINS ISM DIESEL	1999-1999
KENWORTH	T800	CUMMINS 6 CIL, 14.0 L DIESEL	1991-1991	INTERNATIONAL/NAVISTAR	9100I	CUMMINS ISM DIESEL	2000-2003
KENWORTH	T800	CUMMINS N14 DIESEL	1992-1996	INTERNATIONAL/NAVISTAR	9200	CUMMINS ISM DIESEL	1999-1999
K040445				INTERNATIONAL/NAVISTAR	9200	CUMMINS M11 DIESEL	1995-1998
FREIGHTLINER	FLC	CUMMINS N14 DIESEL	1991-1996	INTERNATIONAL/NAVISTAR	9200I	CUMMINS ISM DIESEL	2000-2002
FREIGHTLINER	FLD	CUMMINS N14 DIESEL	1991-1996	INTERNATIONAL/NAVISTAR	9300	CUMMINS M11 DIESEL	1996-1997
INTERNATIONAL/NAVISTAR	5000	CUMMINS N14 DIESEL	1992-1993	INTERNATIONAL/NAVISTAR	9400	CUMMINS ISM DIESEL	1999-1999
INTERNATIONAL/NAVISTAR	PAYSTAR	CUMMINS N14 DIESEL	1992-1993	INTERNATIONAL/NAVISTAR	9400	CUMMINS M11 DIESEL	1996-1997
KENWORTH	K100	CUMMINS 6 CIL, 14.0 L DIESEL	1991-1991	INTERNATIONAL/NAVISTAR	9400I	CUMMINS ISM DIESEL	2000-2003
KENWORTH	K100	CUMMINS N14 DIESEL	1992-1993	INTERNATIONAL/NAVISTAR	9900	CUMMINS ISM DIESEL	1999-1999
KENWORTH	T600	CUMMINS 6 CIL, 14.0 L DIESEL	1991-1991	INTERNATIONAL/NAVISTAR	9900I	CUMMINS ISM DIESEL	2000-2003
KENWORTH	T600	CUMMINS N14 DIESEL	1992-1996	INTERNATIONAL/NAVISTAR	9900IX	CUMMINS ISM DIESEL	2000-2002
KENWORTH	T800	CUMMINS 6 CIL, 14.0 L DIESEL	1991-1991	INTERNATIONAL/NAVISTAR	PAYSTAR	CUMMINS L10 DIESEL	1990-1997
KENWORTH	T800	CUMMINS N14 DIESEL	1992-1996	INTERNATIONAL/NAVISTAR	PAYSTAR	CUMMINS M11 DIESEL	1996-1998
K040490				INTERNATIONAL/NAVISTAR	PAYSTAR	CUMMINS M11 DIESEL	1999-2000
NISSAN	URVAN	4 CIL, 2.4 L	2000-2008	KENWORTH	T2000	CUMMINS M11 DIESEL	1996-1996
K040745				K050340			



MASTER SERVICIO PESADO 2014

BANDAS

MARCA	MODELO	MOTOR	AÑOS	MARCA	MODELO	MOTOR	AÑOS
DINA	S-700	CUMMINS L10 DIESEL	1990-1997	VOLVO	WIA SERIES	CUMMINS M11 DIESEL	1996-1997
FREIGHTLINER	FLC	CUMMINS L10 DIESEL	1990-1993	K050350			
FREIGHTLINER	FLD	CUMMINS L10 DIESEL	1990-1993	FREIGHTLINER	FLC	CUMMINS L10 DIESEL	1991-1993
FREIGHTLINER	FLD120	CUMMINS M11 DIESEL	1994-1994	FREIGHTLINER	FLC	CUMMINS L10 DIESEL	1990-1993
KENWORTH	T400	CUMMINS L10 DIESEL	1990-1997	FREIGHTLINER	FLD	CUMMINS L10 DIESEL	1991-1993
KENWORTH	T400A	CUMMINS L10 DIESEL	1990-1995	FREIGHTLINER	FLD	CUMMINS L10 DIESEL	1990-1993
KENWORTH	T400A	CUMMINS M11 DIESEL	1994-1995	INTERNATIONAL/NAVISTAR	5000	CUMMINS L10 DIESEL	1995-1995
KENWORTH	T450	CUMMINS L10 DIESEL	1990-1995	INTERNATIONAL/NAVISTAR	PAYSTAR	CUMMINS L10 DIESEL	1995-1995
KENWORTH	T450	CUMMINS M11 DIESEL	1990-1999	KENWORTH	T400	CUMMINS L10 DIESEL	1990-1997
KENWORTH	T450B	CUMMINS L10 DIESEL	1992-1994	KENWORTH	T400A	CUMMINS L10 DIESEL	1990-1995
KENWORTH	T600	CUMMINS L10 DIESEL	1990-1997	KENWORTH	T400A	CUMMINS M11 DIESEL	1994-1995
KENWORTH	T600A	CUMMINS L10 DIESEL	1992-1995	KENWORTH	T450	CUMMINS L10 DIESEL	1990-1995
KENWORTH	T800	CUMMINS L10 DIESEL	1990-1997	KENWORTH	T450	CUMMINS M11 DIESEL	1990-1999
VOLVO	WG SERIES	CUMMINS L10 DIESEL	1996-1997	KENWORTH	T450B	CUMMINS L10 DIESEL	1990-1991
VOLVO	XPEDITOR	CUMMINS L10 DIESEL	1996-1996	KENWORTH	T600	CUMMINS L10 DIESEL	1990-1997
K050345				KENWORTH	T600A	CUMMINS L10 DIESEL	1992-1995
FREIGHTLINER	CENTURY CLASS	CUMMINS ISM DIESEL	1998-1998	KENWORTH	T800	CUMMINS L10 DIESEL	1990-1997
FREIGHTLINER	CENTURY CLASS	CUMMINS ISM DIESEL	1999-1999	K050360			
FREIGHTLINER	CENTURY CLASS	CUMMINS M11 DIESEL	1996-1999	STERLING	A-LINE	CUMMINS ISM DIESEL	2000-2001
FREIGHTLINER	CENTURY CLASS	CUMMINS M11 DIESEL	1999-1999	STERLING	L-LINE	CUMMINS ISM DIESEL	2000-2003
FREIGHTLINER	FL112	CUMMINS ISM DIESEL	1998-1998	K050380			
FREIGHTLINER	FL112	CUMMINS ISM DIESEL	1999-1999	VOLVO	WG SERIES	VOLVO VE D12 DIESEL	1998-2001
FREIGHTLINER	FL112	CUMMINS M11 DIESEL	1996-1997	VOLVO	WIA SERIES	VOLVO VE D12 DIESEL	1996-1997
FREIGHTLINER	FLC	CUMMINS M11 DIESEL	1995-1997	K050415			
FREIGHTLINER	FLD	CUMMINS ISM DIESEL	1998-1998	INTERNATIONAL/NAVISTAR	9600	CUMMINS M11 DIESEL	1996-1996
FREIGHTLINER	FLD	CUMMINS ISM DIESEL	1999-1999	INTERNATIONAL/NAVISTAR	9700	CUMMINS M11 DIESEL	1996-1996
FREIGHTLINER	FLD	CUMMINS M11 DIESEL	1995-1998	INTERNATIONAL/NAVISTAR	9800	CUMMINS M11 DIESEL	1997-1997
FREIGHTLINER	FLD	CUMMINS M11 DIESEL	1999-1999	K050420			
FREIGHTLINER	FLD120	CUMMINS M11 DIESEL	1995-1996	VOLVO	VNL	CUMMINS N14 DIESEL	2000-2003
KENWORTH	T400	CUMMINS M11 DIESEL	1995-1997	VOLVO	VNM	CUMMINS N14 DIESEL	2000-2003
KENWORTH	T450	CUMMINS M11 DIESEL	1995-1995	K050435			
KENWORTH	T600	CUMMINS M11 DIESEL	1995-1998	RENAULT	KANGOO	4 CIL, 1.6 L	2005-2013
KENWORTH	T800	CUMMINS M11 DIESEL	1995-1998	RENAULT	KANGOO EXPRESS	4 CIL, 1.6 L	2005-2008
VOLVO	AUTOCAR	CUMMINS ISM DIESEL	1999-1999	K050446			
VOLVO	AUTOCAR	CUMMINS ISM DIESEL	2000-2001	RENAULT	TRAFIC	4 CIL, 1.9 L DIESEL	2008-2009
VOLVO	VNL	CUMMINS ISM DIESEL	2001-2001	K050586			
VOLVO	WCA SERIES	CUMMINS ISM DIESEL	1998-1998	VOLVO	9300	B9	2004-2004
VOLVO	WCA SERIES	CUMMINS M11 DIESEL	1996-1997	K050605			
VOLVO	WG SERIES	CUMMINS ISM DIESEL	2001-2001	IRIZAR	MAN AUTOMATICO	MAN PANORAMICO	2007-2010
VOLVO	WG SERIES	CUMMINS ISM DIESEL	1998-2000	IRIZAR	MAN PANORAMICO	MAN PANORAMICO	2007-2010
VOLVO	WG SERIES	CUMMINS L10 DIESEL	1996-1997	K050688			
VOLVO	WG SERIES	CUMMINS M11 DIESEL	1996-1996	RENAULT	KANGOO	4 CIL, 1.6 L	2005-2013
VOLVO	WG SERIES	CUMMINS M11 DIESEL	1997-1997	RENAULT	KANGOO EXPRESS	4 CIL, 1.6 L	2005-2008
VOLVO	WIA SERIES	CUMMINS ISM DIESEL	1998-1999	K050690			
VOLVO	WIA SERIES	CUMMINS L10 DIESEL	1997-1997	CHEVROLET	TORNADO	4 CIL, 1.8 L	2003-2013



MASTER SERVICIO PESADO 2014

BANDAS

MARCA	MODELO	MOTOR	AÑOS	MARCA	MODELO	MOTOR	AÑOS
K050715				INTERNATIONAL/NAVISTAR	9200	CUMMINS N14 DIESEL	1997-1999
CHEVROLET	TORNADO	4 CIL, 1.8 L	2003-2013	INTERNATIONAL/NAVISTAR	9200I	CUMMINS N14 DIESEL	2000-2002
K060316				INTERNATIONAL/NAVISTAR	9300	CUMMINS N14 DIESEL	1997-1999
PEUGEOT	PARTNER MAXI	4 CIL, 1.6 L TURBO DIESEL	2012-2014	INTERNATIONAL/NAVISTAR	9400	CUMMINS N14 DIESEL	1997-1999
K060340				INTERNATIONAL/NAVISTAR	9400I	CUMMINS N14 DIESEL	2000-2002
INTERNATIONAL/NAVISTAR	9100I	DETROIT DIESEL 6 CIL, 12.7 L DIESEL	2003-2003	INTERNATIONAL/NAVISTAR	9900	CUMMINS N14 DIESEL	1999-1999
INTERNATIONAL/NAVISTAR	9100I	DETROIT DIESEL 6 CIL, 12.7 L DIESEL	2001-2001	INTERNATIONAL/NAVISTAR	9900I	CUMMINS N14 DIESEL	2000-2002
INTERNATIONAL/NAVISTAR	9100I	DETROIT DIESEL SERIE 60	2000-2000	INTERNATIONAL/NAVISTAR	9900IX	CUMMINS N14 DIESEL	2000-2002
INTERNATIONAL/NAVISTAR	9200I	DETROIT DIESEL 6 CIL, 12.7 L DIESEL	2001-2001	STERLING	A-LINE	CUMMINS N14 DIESEL	2001-2003
INTERNATIONAL/NAVISTAR	9200I	DETROIT DIESEL SERIE 60	2000-2000	STERLING	L-LINE	CUMMINS N14 DIESEL	2001-2003
INTERNATIONAL/NAVISTAR	9400	DETROIT DIESEL SERIE 60	1999-1999	VOLVO	VNL	CUMMINS ISM DIESEL	1999-2000
INTERNATIONAL/NAVISTAR	9400I	DETROIT DIESEL 6 CIL, 12.7 L DIESEL	2001-2001	VOLVO	VNL	CUMMINS ISM DIESEL	2003-2003
INTERNATIONAL/NAVISTAR	9400I	DETROIT DIESEL SERIE 60	2000-2000	VOLVO	VNM	CUMMINS ISM DIESEL	2003-2003
INTERNATIONAL/NAVISTAR	9900	DETROIT DIESEL SERIE 60	1999-1999	VOLVO	WIA SERIES	CUMMINS N14 DIESEL	1997-1998
INTERNATIONAL/NAVISTAR	9900I	DETROIT DIESEL 6 CIL, 12.7 L DIESEL	2001-2001	K060420			
INTERNATIONAL/NAVISTAR	9900I	DETROIT DIESEL SERIE 60	2000-2000	STERLING	A-LINE	DETROIT DIESEL 6 CIL, 11.1 L DIESEL	2000-2000
INTERNATIONAL/NAVISTAR	9900IX	DETROIT DIESEL 6 CIL, 12.7 L DIESEL	2001-2001	STERLING	A-LINE	DETROIT DIESEL 6 CIL, 12.7 L DIESEL	2000-2000
INTERNATIONAL/NAVISTAR	9900IX	DETROIT DIESEL SERIE 60	2000-2000	STERLING	A-LINE	DETROIT DIESEL SERIE 60	2001-2001
K060365				STERLING	L-LINE	DETROIT DIESEL 6 CIL, 11.1 L DIESEL	2000-2001
VOLKSWAGEN	PANEL	4 CIL, 1.8 L	1996-2001	STERLING	L-LINE	DETROIT DIESEL 6 CIL, 12.7 L DIESEL	2000-2001
K060384				STERLING	L-LINE	DETROIT DIESEL SERIE 60	2001-2001
PEUGEOT	PARTNER MAXI	4 CIL, 1.6 L TURBO DIESEL	2012-2014	STERLING	SILVER STAR	DETROIT DIESEL SERIE 60	2000-2000
K060385				K060425			
VOLKSWAGEN	VW VAN	4 CIL, 1.6 L	2003-2004	FREIGHTLINER	CENTURY CLASS	CUMMINS N14 DIESEL	1996-1998
VOLKSWAGEN	VW VAN	4 CIL, 1.8 L	2006-2006	FREIGHTLINER	CENTURY CLASS	CUMMINS N14 DIESEL	1998-2001
VOLKSWAGEN	VW VAN	4 CIL, 1.8 L	2005-2005	FREIGHTLINER	CLASSIC	CUMMINS N14 DIESEL	2001-2002
K060393				FREIGHTLINER	CLASSIC XL	CUMMINS N14 DIESEL	2001-2003
FORD	F-450 SUPER DUTY	V8, 6.4 L DIESEL	2008-2008	FREIGHTLINER	COLUMBIA	CUMMINS N14 DIESEL	2003-2003
FORD	F-450 SUPER DUTY	V8, 6.4 L DIESEL	2009-2010	FREIGHTLINER	FLC	CUMMINS N14 DIESEL	1993-1998
FORD	F-450 SUPER DUTY	V8, 6.4 L DIESEL	2009-2010	FREIGHTLINER	FLD	CUMMINS N14 DIESEL	1993-1994
FORD	F-550 SUPER DUTY	V8, 6.4 L DIESEL	2008-2010	FREIGHTLINER	FLD	CUMMINS N14 DIESEL	1997-2003
K060408				INTERNATIONAL/NAVISTAR	5000	CUMMINS N14 DIESEL	1994-1998
INTERNATIONAL/NAVISTAR	5000	CUMMINS N14 DIESEL	1999-2000	INTERNATIONAL/NAVISTAR	8100	CUMMINS N14 DIESEL	1998-1999
INTERNATIONAL/NAVISTAR	5500I	CUMMINS N14 DIESEL	2000-2003	INTERNATIONAL/NAVISTAR	9200I	CUMMINS N14 DIESEL	2003-2003
INTERNATIONAL/NAVISTAR	5600I	CUMMINS N14 DIESEL	2000-2003	INTERNATIONAL/NAVISTAR	9300	CATERPILLAR 3406 DIESEL	1995-1996
INTERNATIONAL/NAVISTAR	5900I	CUMMINS N14 DIESEL	2000-2003	INTERNATIONAL/NAVISTAR	9300	CATERPILLAR 3406 DIESEL	1997-1997
INTERNATIONAL/NAVISTAR	PAYSTAR	CUMMINS N14 DIESEL	1999-2000	INTERNATIONAL/NAVISTAR	9400	CATERPILLAR 3406 DIESEL	1995-1995
K060413				INTERNATIONAL/NAVISTAR	9400	CUMMINS N14 DIESEL	1996-1996
FORD	COURIER	4 CIL, 1.6 L	2003-2012	INTERNATIONAL/NAVISTAR	9400I	CUMMINS N14 DIESEL	2003-2003
K060415				INTERNATIONAL/NAVISTAR	9600	CUMMINS N14 DIESEL	1996-1996
FORD	RANGER	4 CIL, 2.3 L	1996-1997	INTERNATIONAL/NAVISTAR	9700	CUMMINS N14 DIESEL	1996-1996
FORD	RANGER	V6, 3.0 L	1998-1998	INTERNATIONAL/NAVISTAR	9800	CUMMINS N14 DIESEL	1997-1999
FREIGHTLINER	FLD120	CUMMINS N14 DIESEL	1994-1997	INTERNATIONAL/NAVISTAR	9900I	CUMMINS N14 DIESEL	2003-2003
INTERNATIONAL/NAVISTAR	9100	CUMMINS N14 DIESEL	1998-1999	INTERNATIONAL/NAVISTAR	9900IX	CUMMINS N14 DIESEL	2003-2003
INTERNATIONAL/NAVISTAR	9100I	CUMMINS N14 DIESEL	2000-2003	INTERNATIONAL/NAVISTAR	PAYSTAR	CUMMINS N14 DIESEL	1994-1998



MASTER SERVICIO PESADO 2014

BANDAS

MARCA	MODELO	MOTOR	AÑOS	MARCA	MODELO	MOTOR	AÑOS
KENWORTH	T2000	CUMMINS N14 DIESEL	1997-2000	DINA	D-9400	CUMMINS N14 DIESEL	1990-1994
KENWORTH	T600	CUMMINS 6 CIL, 14.0 L DIESEL	1991-1991	DINA	D-9400 EAGLE	CUMMINS NTC 400	1990-1994
KENWORTH	T600	CUMMINS N14 DIESEL	1992-1996	DINA	D-9400 EAGLE	DETROIT DIESEL SERIE 60, 12.7 L	1993-1994
KENWORTH	T600	CUMMINS N14 DIESEL	1997-2001	DINA	S-700	CUMMINS 350	1990-1997
KENWORTH	T800	CUMMINS 6 CIL, 14.0 L DIESEL	1991-1991	KENWORTH	T800	CUMMINS NTC 350	1991-1991
KENWORTH	T800	CUMMINS N14 DIESEL	1992-1996	K060439			
KENWORTH	T800	CUMMINS N14 DIESEL	1997-2003	FREIGHTLINER	CENTURY CLASS	MERCEDES-BENZ MBE 4000 DIESEL	2004-2004
KENWORTH	W900	CUMMINS N14 DIESEL	1993-1996	FREIGHTLINER	COLUMBIA	MERCEDES-BENZ MBE 4000 DIESEL	2003-2004
KENWORTH	W900	CUMMINS N14 DIESEL	1997-2003	FREIGHTLINER	FL112	MERCEDES-BENZ MBE 4000 DIESEL	2003-2004
STERLING	A-LINE	CUMMINS N14 DIESEL	2000-2000	K060441			
STERLING	L-LINE	CUMMINS N14 DIESEL	2000-2000	VOLKSWAGEN	EUROVAN	4 CIL. 1.9 L DIESEL	2005-2008
VOLKSWAGEN	CRAFTER	5 CIL, 2.0 L TDI	2013-2014	VOLKSWAGEN	EUROVAN	4 CIL. 1.9 L DIESEL	2009-2010
VOLKSWAGEN	TRANSPORTER	4 CIL. 2.0 L TDI	2010-2010	K060445			
VOLKSWAGEN	TRANSPORTER	4 CIL. 2.0 L TDI	2011-2014	DINA	S-700	CUMMINS 400	1990-1997
VOLVO	AUTOCAR	CUMMINS N14 DIESEL	1999-2001	K060450			
VOLVO	VNL	CUMMINS N14 DIESEL	1998-2003	INTERNATIONAL/NAVISTAR	9300	DETROIT DIESEL 6 CIL, 11.1 L DIESEL	1995-1997
VOLVO	VNM	CUMMINS N14 DIESEL	1998-2003	INTERNATIONAL/NAVISTAR	9300	DETROIT DIESEL 6 CIL, 12.7 L DIESEL	1995-1997
VOLVO	WG SERIES	CUMMINS N14 DIESEL	1996-1997	INTERNATIONAL/NAVISTAR	9300	DETROIT DIESEL SERIE 60	1998-1998
VOLVO	WIA SERIES	CUMMINS N14 DIESEL	1996-1997	INTERNATIONAL/NAVISTAR	9400	DETROIT DIESEL SERIE 60	1997-1999
K060433				K060455			
STERLING	SILVER STAR	CUMMINS N14 DIESEL	2000-2000	INTERNATIONAL/NAVISTAR	9100	DETROIT DIESEL SERIE 60	1998-1999
STERLING	TRACTO	CUMMINS N14 DIESEL	2000-2000	INTERNATIONAL/NAVISTAR	9100I	DETROIT DIESEL 6 CIL, 12.7 L DIESEL	2001-2001
K060434				INTERNATIONAL/NAVISTAR	9100I	DETROIT DIESEL SERIE 60	2000-2000
KENWORTH	T600	CUMMINS NTC 400	1993-1993	INTERNATIONAL/NAVISTAR	9200	DETROIT DIESEL SERIE 60	1998-1999
K060435				INTERNATIONAL/NAVISTAR	9200I	DETROIT DIESEL 6 CIL, 12.7 L DIESEL	2001-2001
FREIGHTLINER	FLC	CUMMINS N14 DIESEL	1991-1993	INTERNATIONAL/NAVISTAR	9200I	DETROIT DIESEL SERIE 60	2000-2000
FREIGHTLINER	FLD	CUMMINS N14 DIESEL	1991-1993	INTERNATIONAL/NAVISTAR	9400	DETROIT DIESEL 6 CIL, 11.1 L DIESEL	1996-1996
FREIGHTLINER	FLD120	CUMMINS NTC 350	1993-1993	INTERNATIONAL/NAVISTAR	9400	DETROIT DIESEL 6 CIL, 12.7 L DIESEL	1996-1996
INTERNATIONAL/NAVISTAR	5000	CUMMINS N14 DIESEL	1992-1998	INTERNATIONAL/NAVISTAR	9400	DETROIT DIESEL SERIE 60	1997-1999
INTERNATIONAL/NAVISTAR	8100	CUMMINS N14 DIESEL	1995-1999	INTERNATIONAL/NAVISTAR	9400I	DETROIT DIESEL 6 CIL, 12.7 L DIESEL	2001-2001
INTERNATIONAL/NAVISTAR	8200	CUMMINS N14 DIESEL	1995-1998	INTERNATIONAL/NAVISTAR	9400I	DETROIT DIESEL SERIE 60	2000-2000
INTERNATIONAL/NAVISTAR	9300	CUMMINS N14 DIESEL	1995-1995	INTERNATIONAL/NAVISTAR	9600	DETROIT DIESEL 6 CIL, 11.1 L DIESEL	1996-1996
INTERNATIONAL/NAVISTAR	9400	CUMMINS N14 DIESEL	1994-1996	INTERNATIONAL/NAVISTAR	9600	DETROIT DIESEL 6 CIL, 12.7 L DIESEL	1995-1995
INTERNATIONAL/NAVISTAR	9600	CUMMINS N14 DIESEL	1996-1996	INTERNATIONAL/NAVISTAR	9700	DETROIT DIESEL 6 CIL, 11.1 L DIESEL	1996-1996
INTERNATIONAL/NAVISTAR	9700	CUMMINS N14 DIESEL	1996-1996	INTERNATIONAL/NAVISTAR	9700	DETROIT DIESEL 6 CIL, 12.7 L DIESEL	1996-1996
INTERNATIONAL/NAVISTAR	9800	CUMMINS N14 DIESEL	1997-1999	INTERNATIONAL/NAVISTAR	9800	DETROIT DIESEL SERIE 60	1997-1997
INTERNATIONAL/NAVISTAR	PAYSTAR	CUMMINS N14 DIESEL	1992-1998	INTERNATIONAL/NAVISTAR	9900	DETROIT DIESEL SERIE 60	1999-1999
KENWORTH	K100	CUMMINS 6 CIL, 14.0 L DIESEL	1991-1991	INTERNATIONAL/NAVISTAR	9900I	DETROIT DIESEL 6 CIL, 12.7 L DIESEL	2001-2001
KENWORTH	K100	CUMMINS N14 DIESEL	1992-1993	INTERNATIONAL/NAVISTAR	9900I	DETROIT DIESEL SERIE 60	2000-2000
KENWORTH	T600	CUMMINS 6 CIL, 14.0 L DIESEL	1991-1991	INTERNATIONAL/NAVISTAR	9900IX	DETROIT DIESEL 6 CIL, 12.7 L DIESEL	2001-2001
KENWORTH	T600	CUMMINS N14 DIESEL	1992-1996	INTERNATIONAL/NAVISTAR	9900IX	DETROIT DIESEL SERIE 60	2000-2000
KENWORTH	T800	CUMMINS 6 CIL, 14.0 L DIESEL	1991-1991	VOLKSWAGEN	VW VAN	4 CIL, 1.6 L	2004-2004
KENWORTH	T800	CUMMINS N14 DIESEL	1992-1996	VOLKSWAGEN	VW VAN	4 CIL, 1.8 L	2006-2006
VOLVO	WIA SERIES	CUMMINS N14 DIESEL	1996-1997	VOLKSWAGEN	VW VAN	4 CIL, 1.8 L	2005-2005
K060436				K060458			



MASTER SERVICIO PESADO 2014

BANDAS

MARCA	MODELO	MOTOR	AÑOS	MARCA	MODELO	MOTOR	AÑOS
FIAT	DUCATO	4 CIL, 3.0 L DIESEL	2008-2009	INTERNATIONAL/NAVISTAR	5600I	CATERPILLAR C10 DIESEL	2003-2004
FIAT	DUCATO	4 CIL, 3.0 L DIESEL	2010-2013	INTERNATIONAL/NAVISTAR	5600I	CATERPILLAR C12 DIESEL	2003-2004
INTERNATIONAL/NAVISTAR	7300	INTERNATIONAL/NAVISTAR DT466	2002-2003	INTERNATIONAL/NAVISTAR	5900I	CATERPILLAR C10 DIESEL	2003-2003
INTERNATIONAL/NAVISTAR	7400	INTERNATIONAL/NAVISTAR 530 DIESEL	2002-2003	INTERNATIONAL/NAVISTAR	5900I	CATERPILLAR C12 DIESEL	2003-2004
INTERNATIONAL/NAVISTAR	7400	INTERNATIONAL/NAVISTAR DT466	2002-2003	INTERNATIONAL/NAVISTAR	7600	CATERPILLAR C10 DIESEL	2004-2004
INTERNATIONAL/NAVISTAR	7400	INTERNATIONAL/NAVISTAR DT530 DIESEL	2004-2005	INTERNATIONAL/NAVISTAR	7600	CATERPILLAR C12 DIESEL	2004-2004
INTERNATIONAL/NAVISTAR	7500	INTERNATIONAL/NAVISTAR 530 DIESEL	2002-2003	INTERNATIONAL/NAVISTAR	8100	INTERNATIONAL/NAVISTAR 530 DIESEL	1999-2003
INTERNATIONAL/NAVISTAR	7500	INTERNATIONAL/NAVISTAR DT466	2002-2002	K060480			
INTERNATIONAL/NAVISTAR	7500	INTERNATIONAL/NAVISTAR DT530 DIESEL	2004-2005	FREIGHTLINER	CENTURY CLASS	CATERPILLAR C10 DIESEL	1998-1999
PEUGEOT	MANAGER	4 CIL, 3.0 L DIESEL	2008-2009	FREIGHTLINER	CENTURY CLASS	CATERPILLAR C10 DIESEL	2003-2003
PEUGEOT	MANAGER	4 CIL, 3.0 L DIESEL	2010-2013	FREIGHTLINER	CENTURY CLASS	CATERPILLAR C12 DIESEL	1998-1999
K060470				FREIGHTLINER	CENTURY CLASS	CATERPILLAR C12 DIESEL	2003-2004
FREIGHTLINER	CENTURY CLASS	DETROIT DIESEL SERIES 55 DIESEL	1997-1998	FREIGHTLINER	FLD	CATERPILLAR C10 DIESEL	1998-1999
FREIGHTLINER	FL112	DETROIT DIESEL SERIE 55	1997-1998	FREIGHTLINER	FLD	CATERPILLAR C10 DIESEL	2003-2003
FREIGHTLINER	FL112	DETROIT DIESEL SERIES 55 DIESEL	1997-1998	FREIGHTLINER	FLD	CATERPILLAR C12 DIESEL	1998-1999
INTERNATIONAL/NAVISTAR	4700	INTERNATIONAL/NAVISTAR 530 DIESEL	1999-2002	FREIGHTLINER	FLD	CATERPILLAR C12 DIESEL	2003-2003
INTERNATIONAL/NAVISTAR	4700	INTERNATIONAL/NAVISTAR DT408 DIESEL	1995-1997	PEUGEOT	EXPERT	4 CIL, 2.0 L HDI	2008-2010
INTERNATIONAL/NAVISTAR	4700	INTERNATIONAL/NAVISTAR DT466	1997-2000	STERLING	360	MITSUBISHI FUSO 4M50 DIESEL	2008-2013
INTERNATIONAL/NAVISTAR	4700	INTERNATIONAL/NAVISTAR DT466	1995-2002	STERLING	360	MITSUBISHI FUSO 4M50 DIESEL	2006-2007
INTERNATIONAL/NAVISTAR	4800	INTERNATIONAL/NAVISTAR 530 DIESEL	2002-2002	K060483			
INTERNATIONAL/NAVISTAR	4800	INTERNATIONAL/NAVISTAR DT408 DIESEL	1995-1997	INTERNATIONAL/NAVISTAR	7600	CATERPILLAR 3406 DIESEL	2003-2003
INTERNATIONAL/NAVISTAR	4800	INTERNATIONAL/NAVISTAR DT466	1997-2003	INTERNATIONAL/NAVISTAR	7600	CATERPILLAR C10 DIESEL	2002-2003
INTERNATIONAL/NAVISTAR	4800	INTERNATIONAL/NAVISTAR DT466	1995-2002	INTERNATIONAL/NAVISTAR	7600	CATERPILLAR C12 DIESEL	2002-2003
INTERNATIONAL/NAVISTAR	4900	INTERNATIONAL/NAVISTAR 530 DIESEL	1995-2002	K060490			
INTERNATIONAL/NAVISTAR	4900	INTERNATIONAL/NAVISTAR DT408 DIESEL	1995-1997	INTERNATIONAL/NAVISTAR	4300	INTERNATIONAL/NAVISTAR DT466	2002-2004
INTERNATIONAL/NAVISTAR	4900	INTERNATIONAL/NAVISTAR DT466	1997-1997	INTERNATIONAL/NAVISTAR	4400	INTERNATIONAL/NAVISTAR 530 DIESEL	2002-2005
INTERNATIONAL/NAVISTAR	4900	INTERNATIONAL/NAVISTAR DT466	1995-2002	INTERNATIONAL/NAVISTAR	4400	INTERNATIONAL/NAVISTAR DT466	2002-2005
INTERNATIONAL/NAVISTAR	5500I	INTERNATIONAL/NAVISTAR DT466	2001-2002	INTERNATIONAL/NAVISTAR	8500	INTERNATIONAL/NAVISTAR 530 DIESEL	2002-2005
INTERNATIONAL/NAVISTAR	5600I	INTERNATIONAL/NAVISTAR DT466	2001-2002	INTERNATIONAL/NAVISTAR	9100	DETROIT DIESEL SERIE 60	1998-1999
INTERNATIONAL/NAVISTAR	7100	INTERNATIONAL/NAVISTAR DT466	1995-1995	INTERNATIONAL/NAVISTAR	9200	DETROIT DIESEL 6 CIL, 11.1 L DIESEL	1995-1997
INTERNATIONAL/NAVISTAR	8100	INTERNATIONAL/NAVISTAR 530 DIESEL	1995-1998	INTERNATIONAL/NAVISTAR	9200	DETROIT DIESEL 6 CIL, 12.7 L DIESEL	1995-1997
INTERNATIONAL/NAVISTAR	8100	INTERNATIONAL/NAVISTAR DT466	1995-2000	INTERNATIONAL/NAVISTAR	9200	DETROIT DIESEL SERIE 60	1998-1999
INTERNATIONAL/NAVISTAR	8200	INTERNATIONAL/NAVISTAR 530 DIESEL	1996-1997	INTERNATIONAL/NAVISTAR	9300	DETROIT DIESEL 6 CIL, 11.1 L DIESEL	1995-1997
INTERNATIONAL/NAVISTAR	8200	INTERNATIONAL/NAVISTAR DT466	1997-1997	INTERNATIONAL/NAVISTAR	9300	DETROIT DIESEL 6 CIL, 12.7 L DIESEL	1995-1997
INTERNATIONAL/NAVISTAR	9400	DETROIT DIESEL 6 CIL, 11.1 L DIESEL	1995-1995	INTERNATIONAL/NAVISTAR	9300	DETROIT DIESEL SERIE 60	1998-1998
INTERNATIONAL/NAVISTAR	9400	DETROIT DIESEL 6 CIL, 12.7 L DIESEL	1995-1995	INTERNATIONAL/NAVISTAR	9400	DETROIT DIESEL 6 CIL, 11.1 L DIESEL	1996-1996
INTERNATIONAL/NAVISTAR	9600	DETROIT DIESEL 6 CIL, 11.1 L DIESEL	1996-1996	INTERNATIONAL/NAVISTAR	9400	DETROIT DIESEL 6 CIL, 12.7 L DIESEL	1996-1996
INTERNATIONAL/NAVISTAR	9600	DETROIT DIESEL 6 CIL, 12.7 L DIESEL	1995-1995	INTERNATIONAL/NAVISTAR	9400	DETROIT DIESEL SERIE 60	1997-1999
INTERNATIONAL/NAVISTAR	9700	DETROIT DIESEL 6 CIL, 11.1 L DIESEL	1996-1996	K060495			
INTERNATIONAL/NAVISTAR	9700	DETROIT DIESEL 6 CIL, 12.7 L DIESEL	1996-1996	FREIGHTLINER	FLD120	CATERPILLAR C10 DIESEL	2001-2004
INTERNATIONAL/NAVISTAR	9800	DETROIT DIESEL SERIE 60	1997-1997	FREIGHTLINER	FLD120	CATERPILLAR C12 DIESEL	2001-2004
INTERNATIONAL/NAVISTAR	9900I	CATERPILLAR C12 DIESEL	2004-2004	FREIGHTLINER	FLD120	CUMMINS N14 DIESEL	1994-1997
K060478				K060500			
INTERNATIONAL/NAVISTAR	5500I	CATERPILLAR C10 DIESEL	2003-2004	INTERNATIONAL/NAVISTAR	8200	DETROIT DIESEL 6 CIL, 12.7 L DIESEL	1995-1995
INTERNATIONAL/NAVISTAR	5500I	CATERPILLAR C12 DIESEL	2003-2004	INTERNATIONAL/NAVISTAR	9100	CATERPILLAR 3406 DIESEL	1998-1998



MASTER SERVICIO PESADO 2014

BANDAS

MARCA	MODELO	MOTOR	AÑOS	MARCA	MODELO	MOTOR	AÑOS
INTERNATIONAL/NAVISTAR	9200	CATERPILLAR 3406 DIESEL	1996-1996	FREIGHTLINER	ARGOSY	CATERPILLAR C10 DIESEL	2000-2003
INTERNATIONAL/NAVISTAR	9200	CATERPILLAR 3406 DIESEL	1997-1998	FREIGHTLINER	ARGOSY	CATERPILLAR C12 DIESEL	2000-2004
INTERNATIONAL/NAVISTAR	9200I	CATERPILLAR C15 DIESEL	2003-2004	FREIGHTLINER	CENTURY CLASS	CATERPILLAR C10 DIESEL	1998-1999
INTERNATIONAL/NAVISTAR	9200I	CATERPILLAR C16 DIESEL	2003-2003	FREIGHTLINER	CENTURY CLASS	CATERPILLAR C10 DIESEL	2000-2001
INTERNATIONAL/NAVISTAR	9300	CATERPILLAR 3406 DIESEL	1998-1998	FREIGHTLINER	CENTURY CLASS	CATERPILLAR C12 DIESEL	1998-1999
INTERNATIONAL/NAVISTAR	9400	CATERPILLAR 3406 DIESEL	1996-1996	FREIGHTLINER	CENTURY CLASS	CATERPILLAR C12 DIESEL	2000-2001
INTERNATIONAL/NAVISTAR	9400	CATERPILLAR 3406 DIESEL	1997-1999	FREIGHTLINER	COLUMBIA	CATERPILLAR C10 DIESEL	2001-2003
INTERNATIONAL/NAVISTAR	9400I	CATERPILLAR 3406 DIESEL	2000-2000	FREIGHTLINER	COLUMBIA	CATERPILLAR C12 DIESEL	2003-2003
INTERNATIONAL/NAVISTAR	9400I	CATERPILLAR C15 DIESEL	2000-2003	FREIGHTLINER	FL112	CATERPILLAR C10 DIESEL	1999-2000
INTERNATIONAL/NAVISTAR	9400I	CATERPILLAR C16 DIESEL	2000-2003	FREIGHTLINER	FL112	CATERPILLAR C12 DIESEL	1999-2004
INTERNATIONAL/NAVISTAR	9900	CATERPILLAR 3406 DIESEL	1999-1999	FREIGHTLINER	FL112	CUMMINS ISM DIESEL	1999-1999
INTERNATIONAL/NAVISTAR	9900I	CATERPILLAR 3406 DIESEL	2000-2000	FREIGHTLINER	FLD	CATERPILLAR C10 DIESEL	1998-1999
INTERNATIONAL/NAVISTAR	9900I	CATERPILLAR C15 DIESEL	2000-2003	FREIGHTLINER	FLD	CATERPILLAR C10 DIESEL	2000-2004
INTERNATIONAL/NAVISTAR	9900I	CATERPILLAR C16 DIESEL	2000-2003	FREIGHTLINER	FLD	CATERPILLAR C12 DIESEL	1998-1999
INTERNATIONAL/NAVISTAR	9900IX	CATERPILLAR 3406 DIESEL	2000-2000	FREIGHTLINER	FLD	CATERPILLAR C12 DIESEL	2000-2004
INTERNATIONAL/NAVISTAR	9900IX	CATERPILLAR C15 DIESEL	2000-2003	FREIGHTLINER	FLD	CUMMINS ISM DIESEL	1999-1999
INTERNATIONAL/NAVISTAR	9900IX	CATERPILLAR C16 DIESEL	2000-2002	FREIGHTLINER	FLD	CUMMINS M11 DIESEL	1999-1999
K060505				INTERNATIONAL/NAVISTAR	9200I	CATERPILLAR C10 DIESEL	2004-2004
KENWORTH	T800	CATERPILLAR C15 DIESEL	2006-2006	INTERNATIONAL/NAVISTAR	9200I	CATERPILLAR C12 DIESEL	2004-2004
KENWORTH	T800	CATERPILLAR C15 DIESEL	2007-2009	STERLING	A-LINE	CATERPILLAR C10 DIESEL	2002-2004
K060509				STERLING	A-LINE	CATERPILLAR C12 DIESEL	2002-2004
FORD	F-650 SUPER DUTY	FORD V8, 6.0 L DIESEL	2006-2006	K060525			
FORD	F-750 SUPER DUTY	FORD V8, 6.0 L DIESEL	2006-2006	FREIGHTLINER	COLUMBIA	CATERPILLAR C12 DIESEL	2004-2004
INTERNATIONAL/NAVISTAR	4200	INTERNATIONAL/NAVISTAR VT365 DIESEL	2004-2007	INTERNATIONAL/NAVISTAR	4200	INTERNATIONAL/NAVISTAR VT365 DIESEL	2002-2003
INTERNATIONAL/NAVISTAR	CE	INTERNATIONAL/NAVISTAR VT365 DIESEL	2005-2007	INTERNATIONAL/NAVISTAR	4300	INTERNATIONAL/NAVISTAR VT365 DIESEL	2003-2003
K060516				INTERNATIONAL/NAVISTAR	4400	INTERNATIONAL/NAVISTAR VT365 DIESEL	2003-2003
INTERNATIONAL/NAVISTAR	5500	CUMMINS ISM DIESEL	2005-2005	K060529			
INTERNATIONAL/NAVISTAR	5500I	CUMMINS ISM DIESEL	2002-2006	FREIGHTLINER	CENTURY CLASS	CATERPILLAR C10 DIESEL	2002-2002
INTERNATIONAL/NAVISTAR	5600I	CUMMINS ISM DIESEL	2002-2007	FREIGHTLINER	CENTURY CLASS	CATERPILLAR C12 DIESEL	2002-2002
INTERNATIONAL/NAVISTAR	5900I	CUMMINS ISM DIESEL	2001-2006	FREIGHTLINER	FL112	CATERPILLAR C10 DIESEL	2001-2004
INTERNATIONAL/NAVISTAR	7400	CUMMINS ISM DIESEL	2005-2005	FREIGHTLINER	FL112	CATERPILLAR C12 DIESEL	2001-2003
INTERNATIONAL/NAVISTAR	7600	CUMMINS ISM DIESEL	2003-2007	FREIGHTLINER	FLD	CATERPILLAR C10 DIESEL	2002-2002
INTERNATIONAL/NAVISTAR	7700	CUMMINS ISM DIESEL	2005-2006	FREIGHTLINER	FLD	CATERPILLAR C12 DIESEL	2002-2002
INTERNATIONAL/NAVISTAR	8600	CUMMINS ISM DIESEL	2003-2007	K060530			
INTERNATIONAL/NAVISTAR	9000	CUMMINS ISM DIESEL	2004-2004	VOLKSWAGEN	EUROVAN	5 CIL, 2.5 L	2004-2004
INTERNATIONAL/NAVISTAR	9200	CUMMINS ISM DIESEL	2005-2005	K060532			
INTERNATIONAL/NAVISTAR	9200I	CUMMINS ISM DIESEL	2003-2007	VOLKSWAGEN	EUROVAN	5 CIL, 2.5 L	2001-2006
INTERNATIONAL/NAVISTAR	9400I	CUMMINS ISM DIESEL	2004-2007	VOLKSWAGEN	EUROVAN	5 CIL, 2.5 L	2005-2005
INTERNATIONAL/NAVISTAR	TRANSTAR 8600	CUMMINS ISM DIESEL	2008-2008	VOLVO	VHD	CUMMINS ISM DIESEL	2002-2003
INTERNATIONAL/NAVISTAR	WORKSTAR 7600	CUMMINS ISM DIESEL	2008-2010	VOLVO	VNL	CUMMINS ISM DIESEL	2002-2002
INTERNATIONAL/NAVISTAR	WORKSTAR 7600	CUMMINS ISM DIESEL	2008-2008	K060535			
KENWORTH	C500	CATERPILLAR C15 DIESEL	2007-2008	PEUGEOT	PARTNER	4 CIL, 1.6 L DIESEL	2009-2011
K060520				PEUGEOT	PARTNER	4 CIL, 1.6 L HDI	2008-2008
INTERNATIONAL/NAVISTAR	8200	DETROIT DIESEL 6 CIL, 11.1 L DIESEL	1995-1995	K060539			
K060523				KENWORTH	T600	CUMMINS ISM DIESEL	2004-2004



MASTER SERVICIO PESADO 2014

BANDAS

MARCA	MODELO	MOTOR	AÑOS	MARCA	MODELO	MOTOR	AÑOS
KENWORTH	T800	CUMMINS ISM DIESEL	2008-2014	FREIGHTLINER	COLUMBIA	CUMMINS ISM DIESEL	2002-2003
KENWORTH	T800	CUMMINS ISM DIESEL	2003-2007	FREIGHTLINER	FLD120	CUMMINS ISM DIESEL	2001-2002
KENWORTH	W900	CUMMINS ISM DIESEL	2003-2005	KENWORTH	T600	CATERPILLAR C15 DIESEL	2006-2008
KENWORTH	W900	CUMMINS ISM DIESEL	2006-2006	KENWORTH	T800	CATERPILLAR C15 DIESEL	2005-2005
K060547				KENWORTH	T800	CATERPILLAR C15 DIESEL	2006-2009
FREIGHTLINER	ARGOSY	CATERPILLAR 3406 DIESEL	1999-2000	K060578			
FREIGHTLINER	ARGOSY	CATERPILLAR C15 DIESEL	2001-2004	KENWORTH	T800	CATERPILLAR C15 DIESEL	2006-2009
FREIGHTLINER	CLASSIC	CATERPILLAR C15 DIESEL	2003-2003	K060586			
FREIGHTLINER	CLASSIC	CATERPILLAR C16 DIESEL	2003-2003	FREIGHTLINER	CLASSIC	CATERPILLAR C15 DIESEL	2004-2006
FREIGHTLINER	CLASSIC XL	CATERPILLAR C15 DIESEL	2003-2004	FREIGHTLINER	CLASSIC XL	CATERPILLAR C15 DIESEL	2006-2006
FREIGHTLINER	CLASSIC XL	CATERPILLAR C16 DIESEL	2003-2003	FREIGHTLINER	CORONADO	CATERPILLAR C15 DIESEL	2005-2006
FREIGHTLINER	COLUMBIA	CATERPILLAR C15 DIESEL	2001-2003	FREIGHTLINER	FLD	CATERPILLAR C15 DIESEL	2007-2008
FREIGHTLINER	COLUMBIA	CATERPILLAR C16 DIESEL	2001-2004	INTERNATIONAL/NAVISTAR	8100	CATERPILLAR C10 DIESEL	2002-2003
FREIGHTLINER	CORONADO	CATERPILLAR C15 DIESEL	2002-2004	INTERNATIONAL/NAVISTAR	8600	CATERPILLAR C10 DIESEL	2003-2004
FREIGHTLINER	CORONADO	CATERPILLAR C16 DIESEL	2002-2003	INTERNATIONAL/NAVISTAR	8600	CATERPILLAR C12 DIESEL	2003-2004
FREIGHTLINER	FLD	CATERPILLAR C15 DIESEL	2003-2004	MACK	CX SERIES	MACK AC DIESEL	2005-2006
FREIGHTLINER	FLD	CATERPILLAR C16 DIESEL	2003-2004	K060594			
INTERNATIONAL/NAVISTAR	9400	DETROIT DIESEL SERIE 60	1992-1999	FREIGHTLINER	CENTURY CLASS	CATERPILLAR 3406 DIESEL	1998-1999
K060555				FREIGHTLINER	FLD	CATERPILLAR 3406 DIESEL	1998-1999
INTERNATIONAL/NAVISTAR	5600I	CATERPILLAR C15 DIESEL	2004-2004	K060598			
INTERNATIONAL/NAVISTAR	5900I	CATERPILLAR C15 DIESEL	2004-2006	FREIGHTLINER	CENTURY CLASS	CATERPILLAR C15 DIESEL	2001-2004
INTERNATIONAL/NAVISTAR	PAYSTAR 5600I	CATERPILLAR C15 DIESEL	2008-2008	FREIGHTLINER	CLASSIC	CATERPILLAR C15 DIESEL	2001-2002
KENWORTH	W900	CATERPILLAR C15 DIESEL	2006-2007	FREIGHTLINER	CLASSIC	CATERPILLAR C16 DIESEL	2001-2002
K060557				FREIGHTLINER	CLASSIC XL	CATERPILLAR C15 DIESEL	2001-2002
INTERNATIONAL/NAVISTAR	9900	CATERPILLAR C15 DIESEL	2005-2005	FREIGHTLINER	CLASSIC XL	CATERPILLAR C16 DIESEL	2001-2002
INTERNATIONAL/NAVISTAR	9900I	CATERPILLAR C15 DIESEL	2004-2008	FREIGHTLINER	FLD	CATERPILLAR 3406 DIESEL	2000-2000
INTERNATIONAL/NAVISTAR	9900IX	CATERPILLAR C15 DIESEL	2004-2007	FREIGHTLINER	FLD	CATERPILLAR C15 DIESEL	2000-2002
K060559				FREIGHTLINER	FLD	CATERPILLAR C16 DIESEL	2000-2002
FREIGHTLINER	CENTURY CLASS	CUMMINS ISM DIESEL	2001-2001	K060605			
FREIGHTLINER	CENTURY CLASS	CUMMINS M11 DIESEL	1999-2000	INTERNATIONAL/NAVISTAR	9400	CATERPILLAR C15 DIESEL	2005-2005
FREIGHTLINER	CLASSIC	CUMMINS ISM DIESEL	2001-2003	INTERNATIONAL/NAVISTAR	9400I	CATERPILLAR C15 DIESEL	2004-2007
FREIGHTLINER	CLASSIC XL	CUMMINS ISM DIESEL	2001-2003	K060612			
FREIGHTLINER	COLUMBIA	CUMMINS ISM DIESEL	2001-2001	VOLKSWAGEN	TRANSPORTER	4 CIL. 2.0 L TDI	2011-2014
FREIGHTLINER	FL112	CUMMINS ISM DIESEL	2000-2003	VOLKSWAGEN	TRANSPORTER	4 CIL. 2.0 L TDI	2010-2010
FREIGHTLINER	FLD	CUMMINS ISM DIESEL	1999-2003	K060615			
FREIGHTLINER	FLD	CUMMINS M11 DIESEL	1999-2000	KENWORTH	W900	CATERPILLAR C15 DIESEL	2005-2007
K060560				KENWORTH	W900	CATERPILLAR C15 DIESEL	2004-2004
FREIGHTLINER	CENTURY CLASS	CUMMINS ISM DIESEL	1998-1998	PEUGEOT	PARTNER	4 CIL. 1.6 L	2004-2011
FREIGHTLINER	CENTURY CLASS	CUMMINS ISM DIESEL	1999-2000	PEUGEOT	PARTNER	4 CIL. 1.6 L	2005-2005
K060569				K060625			
KENWORTH	T600	CATERPILLAR C15 DIESEL	2005-2005	MACK	CV SERIES	MACK AI DIESEL	2006-2007
KENWORTH	T600	CATERPILLAR C15 DIESEL	2000-2004	MACK	CV SERIES	MACK AMI DIESEL	2006-2006
KENWORTH	T800	CATERPILLAR C15 DIESEL	2004-2004	K060635			
K060575				FREIGHTLINER	CENTURY CLASS	CATERPILLAR C15 DIESEL	2005-2006
FREIGHTLINER	COLUMBIA	CUMMINS ISM DIESEL	2007-2007	FREIGHTLINER	CLASSIC XL	CATERPILLAR C15 DIESEL	2005-2005



MASTER SERVICIO PESADO 2014

BANDAS

MARCA	MODELO	MOTOR	AÑOS	MARCA	MODELO	MOTOR	AÑOS
FREIGHTLINER	COLUMBIA	CATERPILLAR C15 DIESEL	2006-2007	PEUGEOT	MANAGER	4 CIL, 2.2 L DIESEL	2013-2014
FREIGHTLINER	COLUMBIA	CATERPILLAR C15 DIESEL	2005-2005	K060658			
FREIGHTLINER	FLD	CATERPILLAR C15 DIESEL	2005-2006	FORD	E450 SUPER DUTY	FORD V8, 6.0 L DIESEL	2003-2006
VOLKSWAGEN	CRAFTER	5 CIL, 2.0 L TDI	2013-2014	FORD	F-450 SUPER DUTY	FORD V8, 6.0 L DIESEL	2003-2007
K060637				FORD	F-550 SUPER DUTY	FORD V8, 6.0 L DIESEL	2003-2007
CHEVROLET	S-10	4 CIL, 2.2 L	1998-2003	K060660			
INTERNATIONAL/NAVISTAR	5500I	CUMMINS ISX DIESEL	2003-2007	CHEVROLET	C5500	GM V8 7.4 L	1999-2000
INTERNATIONAL/NAVISTAR	5600	CUMMINS ISX DIESEL	2005-2005	CHEVROLET	C6500	GM V8 7.4 L	1999-2000
INTERNATIONAL/NAVISTAR	5600I	CUMMINS ISX DIESEL	2005-2007	CHEVROLET	C7500	GM V8 7.4 L	1999-2000
INTERNATIONAL/NAVISTAR	5900I	CUMMINS ISX DIESEL	2003-2007	CHEVROLET	C8500	GM V8 7.4 L	1999-2000
INTERNATIONAL/NAVISTAR	9000	CUMMINS ISX DIESEL	2004-2004	CHEVROLET	KODIAK	GM V8, 7.4 L	1995-2000
INTERNATIONAL/NAVISTAR	9200	CUMMINS ISX DIESEL	2005-2005	FORD	TRANSIT	4 CIL, 2.2 L TDI	2009-2013
INTERNATIONAL/NAVISTAR	9200I	CUMMINS ISX DIESEL	2003-2004	FORD	TRANSIT	4 CIL, 2.2 L TDI	2008-2008
INTERNATIONAL/NAVISTAR	9200I	CUMMINS ISX DIESEL	2005-2013	FORD	TRANSIT	4 CIL, 2.2 L TDI	2008-2008
INTERNATIONAL/NAVISTAR	9400	CUMMINS ISX DIESEL	2005-2005	FREIGHTLINER	FLD	CUMMINS SIGNATURE 600 DIESEL	1998-1999
INTERNATIONAL/NAVISTAR	9400I	CUMMINS ISX DIESEL	2003-2004	KENWORTH	T2000	CUMMINS SIGNATURE 600 DIESEL	1999-1999
INTERNATIONAL/NAVISTAR	9400I	CUMMINS ISX DIESEL	2005-2007	MACK	CL SERIES	CUMMINS ISX DIESEL	2004-2007
INTERNATIONAL/NAVISTAR	9900	CUMMINS ISX DIESEL	2005-2005	MACK	CT SERIES	MACK AMI DIESEL	2006-2006
INTERNATIONAL/NAVISTAR	9900I	CUMMINS ISX DIESEL	2003-2008	K060670			
INTERNATIONAL/NAVISTAR	9900IX	CUMMINS ISX DIESEL	2004-2007	FORD	COURIER	4 CIL, 1.6 L	2003-2012
INTERNATIONAL/NAVISTAR	9900IX	CUMMINS ISX DIESEL	2003-2003	MACK	CH SERIES	MACK AC DIESEL	2003-2004
INTERNATIONAL/NAVISTAR	PAYSTAR 5500i	CUMMINS ISX DIESEL	2008-2008	MACK	CH SERIES	MACK AC DIESEL	2006-2006
INTERNATIONAL/NAVISTAR	PAYSTAR 5900i	CUMMINS ISX DIESEL	2008-2008	K060672			
INTERNATIONAL/NAVISTAR	PROSTAR SERIES	CUMMINS ISX DIESEL	2009-2012	CHEVROLET	C5500	GM V8 6.0 L	1997-1998
INTERNATIONAL/NAVISTAR	PROSTAR SERIES	CUMMINS ISX DIESEL	2007-2008	CHEVROLET	C5500	GM V8 7.0 L	1997-1998
KENWORTH	T2000	CATERPILLAR C15 DIESEL	2004-2010	CHEVROLET	C6500	CATERPILLAR 3116 DIESEL	1997-1998
KENWORTH	T2000	CUMMINS ISX DIESEL	2004-2006	CHEVROLET	C6500	GM V8 6.0 L	1997-1998
KENWORTH	T600	CUMMINS ISX DIESEL	2002-2010	CHEVROLET	C6500	GM V8 7.0 L	1997-1998
KENWORTH	T660	CUMMINS ISX DIESEL	2007-2014	CHEVROLET	C7500	CATERPILLAR 3116 DIESEL	1997-1998
KENWORTH	T800	CUMMINS ISX DIESEL	2004-2012	CHEVROLET	C7500	GM V8 6.0 L	1997-1998
KENWORTH	T800	CUMMINS ISX DIESEL	2005-2007	CHEVROLET	C7500	GM V8 7.0 L	1997-1998
KENWORTH	T800	CUMMINS ISX DIESEL	2013-2014	CHEVROLET	C8500	CATERPILLAR 3116 DIESEL	1997-1998
KENWORTH	W900	CUMMINS ISX DIESEL	2010-2013	CHEVROLET	C8500	GM V8 6.0 L	1997-1998
KENWORTH	W900	CUMMINS ISX DIESEL	2004-2007	CHEVROLET	C8500	GM V8 7.0 L	1997-1998
KENWORTH	W900	CUMMINS ISX DIESEL	2003-2003	MACK	CH SERIES	MACK AC DIESEL	2005-2005
VOLVO	VNL	CUMMINS ISX DIESEL	2004-2013	PEUGEOT	PARTNER	4 CIL, 1.6 L DIESEL	2009-2011
VOLVO	VNL	CUMMINS ISX DIESEL	2003-2003	PEUGEOT	PARTNER	4 CIL, 1.6 L HDI	2008-2008
VOLVO	VNL	CUMMINS SIGNATURE 600 DIESEL	2003-2003	K060675			
VOLVO	VNM	CUMMINS ISX DIESEL	2004-2013	INTERNATIONAL/NAVISTAR	CE	INTERNATIONAL/NAVISTAR DT466	2003-2004
VOLVO	VNM	CUMMINS ISX DIESEL	2003-2003	K060680			
VOLVO	VNM	CUMMINS SIGNATURE 600 DIESEL	2003-2003	INTERNATIONAL/NAVISTAR	9200I	CUMMINS SIGNATURE 600 DIESEL	2000-2002
VOLVO	VT880	CUMMINS ISX DIESEL	2006-2006	K060685			
K060653				FORD	F-450 SUPER DUTY	V8, 7.5 L	1998-1998
CHEVROLET	S-10	4 CIL, 2.2 L	1994-1997	FREIGHTLINER	ARGOSY	CUMMINS ISX DIESEL	1999-2003
MACK	CT SERIES	MACK AMI DIESEL	2006-2006	FREIGHTLINER	CENTURY CLASS	CUMMINS ISX DIESEL	2000-2001



MASTER SERVICIO PESADO 2014

BANDAS

MARCA	MODELO	MOTOR	AÑOS	MARCA	MODELO	MOTOR	AÑOS
FREIGHTLINER	COLUMBIA	CUMMINS ISX DIESEL	2001-2001			K060730	
FREIGHTLINER	FLD	CUMMINS ISX DIESEL	2002-2003	FORD	RANGER	4 CIL, 2.3 L	2001-2012
FREIGHTLINER	FLD	CUMMINS ISX DIESEL	1999-2001			K060735	
INTERNATIONAL/NAVISTAR	9100I	CUMMINS ISX DIESEL	2001-2003	MACK	CX SERIES	MACK AC DIESEL	2003-2006
INTERNATIONAL/NAVISTAR	9400I	CUMMINS ISX DIESEL	2000-2002			K060736	
INTERNATIONAL/NAVISTAR	9900I	CUMMINS ISX DIESEL	2000-2002	KENWORTH	T660	CATERPILLAR C15 DIESEL	2007-2013
INTERNATIONAL/NAVISTAR	9900IX	CUMMINS ISX DIESEL	2000-2003	KENWORTH	T800	CATERPILLAR C15 DIESEL	2010-2013
KENWORTH	T2000	CUMMINS ISX DIESEL	1999-2003			K060739	
KENWORTH	T2000	CUMMINS ISX DIESEL	2001-2001	MACK	CXN SERIES	MACK AC DIESEL	2006-2007
KENWORTH	T600	CUMMINS SIGNATURE 600 DIESEL	2003-2003			K060744	
KENWORTH	T800	CUMMINS ISX DIESEL	1999-2003	CHEVROLET	S-10	4 CIL, 2.2 L	1998-2002
KENWORTH	W900	CUMMINS ISX DIESEL	1999-2002	CHEVROLET	S-10	4 CIL, 2.2 L	2003-2003
KENWORTH	W900	CUMMINS ISX DIESEL	2003-2003			K060747	
KENWORTH	W900	CUMMINS SIGNATURE 600 DIESEL	2000-2002	MACK	CXN SERIES	MACK AC DIESEL	2007-2007
MACK	CH SERIES	CUMMINS SIGNATURE 600 DIESEL	2001-2003	MACK	CXN SERIES	MACK AC DIESEL	2006-2006
MACK	CL SERIES	CUMMINS SIGNATURE 600 DIESEL	2001-2003			K060755	
STERLING	L-LINE	CUMMINS ISC DIESEL	2001-2001	CHEVROLET	S-10	4 CIL, 2.2 L	1994-1997
STERLING	L-LINE	CUMMINS ISX DIESEL	2001-2001			K060760	
STERLING	L-LINE	CUMMINS SIGNATURE 600 DIESEL	2001-2001	DINA	D-500 HTQ	CATERPILLAR 3126 DIESEL	1996-2000
STERLING	SILVER STAR	CUMMINS SIGNATURE 600 DIESEL	2001-2001	DINA	D-600 HTQ	CATERPILLAR 3126 DIESEL	1996-2000
VOLVO	VNL	CUMMINS ISX DIESEL	2000-2003			K060790	
VOLVO	VNL	CUMMINS SIGNATURE 600 DIESEL	2003-2003	VOLKSWAGEN	CRAFTER	5 CIL, 2.5 L TDI	2008-2013
VOLVO	VNM	CUMMINS ISX DIESEL	2002-2003			K060795	
VOLVO	VNM	CUMMINS SIGNATURE 600 DIESEL	2003-2003	MACK	CV SERIES	MACK AI DIESEL	2005-2005
		K060690		MACK	CV SERIES	MACK AI DIESEL	2006-2007
KENWORTH	W900	CATERPILLAR C15 DIESEL	2008-2010	MACK	CV SERIES	MACK AMI DIESEL	2004-2006
		K060696				K060806	
FORD	RANGER	4 CIL, 2.3 L	1996-1997	FORD	E450 SUPER DUTY	FORD V10, 6.8 L	2002-2009
FORD	RANGER	4 CIL, 2.5 L	1999-2001	FORD	E450 SUPER DUTY	FORD V8, 5.4 L	2002-2005
FORD	RANGER	V6, 3.0 L	1998-1998	FORD	E550 SUPER DUTY	FORD V10, 6.8 L	2002-2003
INTERNATIONAL/NAVISTAR	DURASTAR 4300	INTERNATIONAL/NAVISTAR MAXXFORCE 7 DIESEL	2010-2010	FORD	F-350 SUPER DUTY	V10, 6.8 L	2003-2003
		K060708		FORD	F-350 SUPER DUTY	V8, 5.4 L	2010-2010
RENAULT	TRAFIC	4 CIL, 1.9 L DIESEL	2008-2009	FORD	F-350 SUPER DUTY	V8, 5.4 L	2004-2010
		K060716		FORD	F-350 SUPER DUTY	V8, 5.4 L	2003-2003
MACK	LE SERIES	MACK AI DIESEL	2005-2006	FORD	F-450 SUPER DUTY	FORD V10, 6.8 L	2002-2006
MACK	LE SERIES	MACK AMI DIESEL	2007-2007	FORD	F-450 SUPER DUTY	V10, 6.8 L	2007-2010
MACK	MR SERIES	MACK AI DIESEL	2005-2006	FORD	F-450 SUPER DUTY	V10, 6.8 L	2008-2013
MACK	MR SERIES	MACK AMI DIESEL	2007-2007	FORD	F-450 SUPER DUTY	V8, 5.4 L	2003-2004
MACK	MR SERIES	MACK AMI DIESEL	2003-2005	FORD	F-550 SUPER DUTY	FORD V10, 6.8 L	2002-2006
MACK	MR SERIES	MACK AMI DIESEL	2006-2006	FORD	F-550 SUPER DUTY	V10, 6.8 L	2008-2010
		K060721				K060810	
KENWORTH	T2000	CUMMINS ISX INTERBRAKE	2000-2000	FORD	RANGER	V6, 4.0 L	1999-2001
		K060723				K060820	
FREIGHTLINER	COLUMBIA	CATERPILLAR C15 DIESEL	2008-2009	FORD	RANGER	4 CIL, 2.3 L	1996-1997
FREIGHTLINER	FLD	CATERPILLAR C15 DIESEL	2009-2010	FORD	RANGER	4 CIL, 2.5 L	1999-2001



MASTER SERVICIO PESADO 2014

BANDAS

MARCA	MODELO	MOTOR	AÑOS	MARCA	MODELO	MOTOR	AÑOS
FORD	RANGER	V6, 3.0 L	1998-1998	K060910			
				CHEVROLET	C4500	GM V8 8.1 L	2007-2007
FORD	RANGER	4 CIL, 2.3 L	2001-2007	CHEVROLET	C4500	GM V8 8.1 L	2003-2003
				CHEVROLET	C5500	GM V8 8.1 L	2007-2007
FORD	RANGER	4 CIL, 2.3 L	2011-2012	CHEVROLET	C5500	GM V8 8.1 L	2003-2003
FORD	RANGER	4 CIL, 2.3 L	2008-2010	K060938			
MACK	CT SERIES	MACK AI DIESEL	2006-2007	CHEVROLET	S-10	V6, 4.3 L	1991-1995
				K060950			
MACK	CT SERIES	MACK AI DIESEL	2006-2007	CHEVROLET	S-10	V6, 4.3 L	1996-2002
MACK	CT SERIES	MACK AMI DIESEL	2006-2006	K060956			
				CHEVROLET	S-10	V6, 4.3 L	1991-1995
MACK	CT SERIES	MACK AMI DIESEL	2006-2006	K060984			
VOLKSWAGEN	EUROVAN	5 CIL, 2.5 L	2001-2003	FORD	E450 SUPER DUTY	FORD V10, 6.8 L	2006-2006
				K060988			
MACK	CH SERIES	MACK AC DIESEL	2003-2004	CHEVROLET	C4500	GM V8 8.1 L	2003-2005
MACK	CHN SERIES	MACK AC DIESEL	2006-2007	CHEVROLET	C5500	GM V8 8.1 L	2003-2005
				K060990			
FORD	COURIER	4 CIL, 1.6 L	2003-2012	FORD	E450 SUPER DUTY	FORD V10, 6.8 L	2004-2005
				FORD	E450 SUPER DUTY	FORD V10, 6.8 L	2002-2006
FORD	RANGER	V6, 3.0 L	1996-2002	FORD	E450 SUPER DUTY	FORD V8, 5.4 L	2002-2005
FREIGHTLINER	BUSINESS CLASS M2	CATERPILLAR C13 DIESEL	2009-2010	FORD	E550 SUPER DUTY	FORD V10, 6.8 L	2002-2003
KENWORTH	T660	CATERPILLAR C13 DIESEL	2009-2013	FORD	F-350 SUPER DUTY	V8, 5.4 L	2010-2010
KENWORTH	T800	CATERPILLAR C13 DIESEL	2008-2014	FORD	F-350 SUPER DUTY	V8, 5.4 L	2010-2010
KENWORTH	W900	CATERPILLAR C13 DIESEL	2008-2010	FORD	F-450 SUPER DUTY	V10, 6.8 L	2008-2013
				FORD	F-450 SUPER DUTY	V10, 6.8 L	2009-2010
FORD	RANGER	V6, 4.2 L	2004-2004	FORD	F-550 SUPER DUTY	V10, 6.8 L	2008-2010
				K060994			
CHEVROLET	S-10	V6, 4.3 L	1996-2002	CHEVROLET	C4500	GM V8 8.1 L	2008-2008
VOLKSWAGEN	EUROVAN	5 CIL, 2.5 L	2001-2006	CHEVROLET	C4500	GM V8 8.1 L	2007-2007
VOLKSWAGEN	EUROVAN	5 CIL, 2.5 L	2005-2005	CHEVROLET	C4500	GM V8 8.1 L	2003-2006
				CHEVROLET	C5500	GM V8 8.1 L	2008-2008
FORD	COURIER	4 CIL, 1.6 L	2003-2012	CHEVROLET	C5500	GM V8 8.1 L	2007-2007
FORD	RANGER	V6, 3.0 L	1996-2002	CHEVROLET	C5500	GM V8 8.1 L	2003-2006
FORD	RANGER	V6, 4.0 L	1999-2001	K060997			
				FORD	E450 SUPER DUTY	FORD V10, 6.8 L	2007-2009
MERCEDES BENZ	SPRINTER	4 CIL, 2.2 L CDI	2006-2013	FORD	F-350 SUPER DUTY	V10, 6.8 L	2003-2003
MERCEDES BENZ	VITO	4 CIL, 2.2 L CDI	2009-2013	FORD	F-350 SUPER DUTY	V8, 5.4 L	2003-2003
				FORD	F-350 SUPER DUTY	V8, 5.4 L	2005-2009
MERCEDES BENZ	SPRINTER	5 CIL, 2.7 L CDI	2003-2006	FORD	F-450 SUPER DUTY	FORD V10, 6.8 L	2006-2006
				FORD	F-450 SUPER DUTY	V10, 6.8 L	2005-2007
MERCEDES BENZ	SPRINTER	4 CIL, 2.2 L CDI	2008-2013	FORD	F-450 SUPER DUTY	V8, 5.4 L	2003-2004
MERCEDES BENZ	VITO	4 CIL, 2.2 L CDI	2009-2013	FORD	F-550 SUPER DUTY	FORD V10, 6.8 L	2006-2006
				K061000			
CHEVROLET	C4500	GM V8 8.1 L	2003-2005	FORD	F-350 SUPER DUTY	V8, 5.4 L	2004-2004
CHEVROLET	C5500	GM V8 8.1 L	2003-2005	FORD	F-450 SUPER DUTY	FORD V10, 6.8 L	2002-2005



MASTER SERVICIO PESADO 2014

BANDAS

MARCA	MODELO	MOTOR	AÑOS	MARCA	MODELO	MOTOR	AÑOS
FORD	F-550 SUPER DUTY	FORD V10, 6.8 L	2002-2005			K070694	
		K061005		NISSAN	URVAN	4 CIL, 3.0 L DIESEL	2009-2013
FORD	F-350 SUPER DUTY	V8, 5.4 L	2010-2010			K070705	
FORD	F-350 SUPER DUTY	V8, 5.4 L	2010-2010	CHEVROLET	C5500	CATERPILLAR 3116 DIESEL	1999-1999
FORD	F-450 SUPER DUTY	V10, 6.8 L	2008-2013	CHEVROLET	C5500	CATERPILLAR 3126 DIESEL	1998-2002
FORD	F-450 SUPER DUTY	V10, 6.8 L	2009-2010	CHEVROLET	C6500	CATERPILLAR 3116 DIESEL	1997-2000
FORD	F-550 SUPER DUTY	V10, 6.8 L	2008-2010	CHEVROLET	C6500	CATERPILLAR 3126 DIESEL	1998-2002
		K061020		CHEVROLET	C7500	CATERPILLAR 3116 DIESEL	1997-2000
VOLKSWAGEN	CRAFTER	5 CIL, 2.5 L TDI	2008-2013	CHEVROLET	C7500	CATERPILLAR 3126 DIESEL	1998-2002
		K061058		CHEVROLET	C8500	CATERPILLAR 3116 DIESEL	1997-2000
CHEVROLET	C4500	GM V8 8.1 L	2007-2007	CHEVROLET	C8500	CATERPILLAR 3126 DIESEL	1998-2002
CHEVROLET	C4500	GM V8 8.1 L	2003-2006	CHEVROLET	KODIAK	CATERPILLAR 3116 DIESEL	1996-1996
CHEVROLET	C5500	GM V8 8.1 L	2007-2007	CHEVROLET	KODIAK	CATERPILLAR 3116 DIESEL	1997-2000
CHEVROLET	C5500	GM V8 8.1 L	2003-2006	CHEVROLET	KODIAK	CATERPILLAR 3126 DIESEL	2000-2008
FORD	F-350 SUPER DUTY	V8, 6.2 L	2011-2013			K070709	
FORD	F-350 SUPER DUTY	V8, 6.2 L	2011-2012	CHEVROLET	C6500	CATERPILLAR 3126 DIESEL	2003-2003
		K061140		CHEVROLET	C7500	CATERPILLAR 3126 DIESEL	2003-2003
CHEVROLET	C4500	GM V8 8.1 L	2007-2007	CHEVROLET	C8500	CATERPILLAR 3126 DIESEL	2003-2003
CHEVROLET	C4500	GM V8 8.1 L	2003-2005			K070733	
CHEVROLET	C5500	GM V8 8.1 L	2007-2007	CHEVROLET	C5500	CATERPILLAR 3116 DIESEL	1999-1999
CHEVROLET	C5500	GM V8 8.1 L	2003-2005	CHEVROLET	C5500	CATERPILLAR 3126 DIESEL	1998-2002
		K061187		CHEVROLET	C6500	CATERPILLAR 3116 DIESEL	1999-2000
CHEVROLET	C4500	GM V8 6.6 L DIESEL	2003-2007	CHEVROLET	C6500	CATERPILLAR 3126 DIESEL	1998-2002
CHEVROLET	C5500	GM V8 6.6 L DIESEL	2003-2007	CHEVROLET	C7500	CATERPILLAR 3116 DIESEL	1999-2000
		K061195		CHEVROLET	C7500	CATERPILLAR 3126 DIESEL	1998-2002
CHEVROLET	C4500	GM V8 6.6 L DIESEL	2003-2007	CHEVROLET	C8500	CATERPILLAR 3116 DIESEL	1999-2000
CHEVROLET	C5500	GM V8 6.6 L DIESEL	2003-2007	CHEVROLET	C8500	CATERPILLAR 3126 DIESEL	1998-2002
		K061360		CHEVROLET	KODIAK	CATERPILLAR 3116 DIESEL	1997-2000
CHEVROLET	C4500	GM V8 6.6 L DIESEL	2003-2007	CHEVROLET	KODIAK	CATERPILLAR 3126 DIESEL	2000-2008
CHEVROLET	C5500	GM V8 6.6 L DIESEL	2003-2007			K070735	
		K070390		CHEVROLET	C6500	CATERPILLAR 3116 DIESEL	1997-1998
ISUZU	ELF 300	4JJ1-TC	2007-2011	CHEVROLET	C7500	CATERPILLAR 3116 DIESEL	1997-1998
		K070404		CHEVROLET	C7500	CATERPILLAR 3126 DIESEL	1999-1999
ISUZU	ELF 200	4JJ1-TC	2011-2014	CHEVROLET	C8500	CATERPILLAR 3116 DIESEL	1997-1998
ISUZU	ELF 200	4JJ1-TC	2009-2010	CHEVROLET	KODIAK	CATERPILLAR 3116 DIESEL	1996-1996
ISUZU	ELF 300	4JJ1-TC	2012-2014	TOYOTA	HIACE	4 CIL, 2.7 L	2006-2013
		K070406				K070786	
ISUZU	ELF 300	4JJ1-TC	2007-2011	CHEVROLET	C6500	ISUZU 6HK1-TC DIESEL	2003-2007
		K070425		CHEVROLET	C7500	ISUZU 6HK1-TC DIESEL	2003-2007
FIAT	DUCATO	4 CIL, 2.3 L DIESEL	2008-2013	CHEVROLET	C8500	ISUZU 6HK1-TC DIESEL	2003-2007
ISUZU	FORWARD 800	4HK1-TC	2012-2014			K070825	
		K070505		CHEVROLET	C6500	CATERPILLAR 3116 DIESEL	1997-1998
NISSAN	CABSTAR	NISSAN DIESEL YD25DDTI	2008-2013	CHEVROLET	C7500	CATERPILLAR 3116 DIESEL	1997-1998
		K070673		CHEVROLET	C8500	CATERPILLAR 3116 DIESEL	1997-1998
CHEVROLET	KODIAK	CATERPILLAR 3116 DIESEL	1996-1996			K070835	



MASTER SERVICIO PESADO 2014

BANDAS

MARCA	MODELO	MOTOR	AÑOS	MARCA	MODELO	MOTOR	AÑOS
CHEVROLET	C6500	CATERPILLAR 3126 DIESEL	2003-2003	VOLVO	VNL	VOLVO VE D12 DIESEL	1998-2003
CHEVROLET	C7500	CATERPILLAR 3126 DIESEL	2003-2003	VOLVO	VNM	VOLVO VE 12 DIESEL	2000-2000
CHEVROLET	C8500	CATERPILLAR 3126 DIESEL	2003-2003	VOLVO	VNM	VOLVO VE D12 DIESEL	2002-2003
K070840				K080382			
NISSAN	URVAN	4 CIL. 2.5 L	2009-2013	VOLVO	VHD	VOLVO VE 12 DIESEL	2002-2002
K070873				K080384			
NISSAN	NV2500	V6, 4.0 L	2013-2014	VOLVO	VNL	CUMMINS N14 DIESEL	1998-1999
K070880				VOLVO	VNM	CUMMINS N14 DIESEL	1998-1999
DODGE	RAM-4000	V6, 5.9 L DIESEL	1998-2001	K080385			
DODGE	RAM-4000	V6, 5.9 L DIESEL	1997-1997	VOLVO	VHD	VOLVO VE D12 DIESEL	2005-2006
K070901				VOLVO	VNL	VOLVO VE D12 DIESEL	2004-2008
TOYOTA	HIACE	4 CIL. 2.7 L	2006-2013	VOLVO	VNM	VOLVO VE D12 DIESEL	2006-2008
K070961				K080400			
NISSAN	NV2500	V8, 5.6 L	2013-2014	VOLVO	VNL	VOLVO VE 12 DIESEL	1999-1999
K070975				VOLVO	VNM	VOLVO VE 12 DIESEL	1999-1999
DODGE	RAM-4000	V6, 5.9 L DIESEL	1997-1997	VOLVO	WIA SERIES	CUMMINS N14 DIESEL	1996-1998
DODGE	RAM-4000	V6, 5.9 L DIESEL	1998-2002	K080408			
K071040				VOLVO	VNL	VOLVO VE 12 DIESEL	1999-1999
DODGE	RAM-4000	V6, 5.9 L DIESEL	1998-2001	VOLVO	VNM	VOLVO VE 12 DIESEL	1999-1999
DODGE	RAM-4000	V6, 5.9 L DIESEL	1995-1997	K080415			
K071045				KENWORTH	K100	CUMMINS 6 CIL, 14.0 L DIESEL	1991-1991
DODGE	RAM-4000	V6, 5.9 L DIESEL	1995-1996	KENWORTH	K100	CUMMINS N14 DIESEL	1992-1993
K071056				KENWORTH	T600	CUMMINS 6 CIL, 14.0 L DIESEL	1991-1991
CHEVROLET	C5500	GM V8 8.1 L	2001-2002	KENWORTH	T600	CUMMINS N14 DIESEL	1992-1996
CHEVROLET	C6500	GM V8 8.1 L	2001-2008	KENWORTH	T800	CUMMINS 6 CIL, 14.0 L DIESEL	1991-1991
CHEVROLET	C6500	GM V8 8.1 L	2007-2007	KENWORTH	T800	CUMMINS N14 DIESEL	1992-1996
CHEVROLET	C7500	GM V8 8.1 L	2001-2008	VOLVO	7550	7550	2001-2006
CHEVROLET	C8500	GM V8 8.1 L	2001-2008	VOLVO	7550 FL	B12	2005-2008
CHEVROLET	KODIAK	GM V8, 8.1 L	2001-2008	VOLVO	9700	B12	2002-2006
K071130				VOLVO	WIA SERIES	CUMMINS N14 DIESEL	1996-1998
DODGE	RAM-4000	V6, 5.9 L DIESEL	1997-1997	K080427			
DODGE	RAM-4000	V6, 5.9 L DIESEL	1998-2000	KENWORTH	K100	CUMMINS 6 CIL, 14.0 L DIESEL	1991-1991
K071141				KENWORTH	K100	CUMMINS N14 DIESEL	1992-1993
DODGE	RAM-4000	V6, 5.9 L DIESEL	1995-1996	KENWORTH	T600	CUMMINS 6 CIL, 14.0 L DIESEL	1991-1991
K071157				KENWORTH	T600	CUMMINS N14 DIESEL	1992-1996
DODGE	RAM-6500	V8, 5.9 L	1994-1997	KENWORTH	T800	CUMMINS 6 CIL, 14.0 L DIESEL	1991-1991
K071247				KENWORTH	T800	CUMMINS N14 DIESEL	1992-1996
CHEVROLET	C5500	GM V8 8.1 L	2001-2002	VOLVO	7550	7550	2001-2006
CHEVROLET	C6500	GM V8 8.1 L	2001-2008	VOLVO	7550 FL	B12	2005-2008
CHEVROLET	C7500	GM V8 8.1 L	2001-2008	VOLVO	9700	B12	2002-2006
CHEVROLET	C8500	GM V8 8.1 L	2001-2008	VOLVO	WIA SERIES	CUMMINS N14 DIESEL	1996-1998
CHEVROLET	KODIAK	GM V8, 8.1 L	2001-2008	K080435			
K080375				VOLVO	WG SERIES	CUMMINS N14 DIESEL	1996-1997
VOLVO	VHD	VOLVO VE D12 DIESEL	2003-2004	K080465			
VOLVO	VNL	VOLVO VE 12 DIESEL	2000-2000	INTERNATIONAL/NAVISTAR	9100	CUMMINS ISM DIESEL	1999-1999



MASTER SERVICIO PESADO 2014

BANDAS

MARCA	MODELO	MOTOR	AÑOS	MARCA	MODELO	MOTOR	AÑOS
INTERNATIONAL/NAVISTAR	9200	CUMMINS ISM DIESEL	1999-1999	INTERNATIONAL/NAVISTAR	8100	CUMMINS L10 DIESEL	1995-1996
INTERNATIONAL/NAVISTAR	9400	CUMMINS ISM DIESEL	1999-1999	K080505			
INTERNATIONAL/NAVISTAR	9900	CUMMINS ISM DIESEL	1999-1999	FREIGHTLINER	BUSINESS CLASS	MERCEDES BENZ MBE 4000 Diesel	2007-2010
KENWORTH	K100	CUMMINS 6 CIL, 14.0 L DIESEL	1991-1991	FREIGHTLINER	BUSINESS CLASS M2	MERCEDES-BENZ MBE 4000 DIESEL	2005-2007
KENWORTH	K100	CUMMINS N14 DIESEL	1992-1993	FREIGHTLINER	CASCADIA	MERCEDES BENZ MBE 4000 Diesel	2008-2012
KENWORTH	T400	CUMMINS L10 DIESEL	1990-1997	FREIGHTLINER	CENTURY CLASS	MERCEDES BENZ MBE 4000 Diesel	2009-2010
KENWORTH	T400A	CUMMINS L10 DIESEL	1990-1995	FREIGHTLINER	CLASSIC	MERCEDES BENZ MBE 4000 Diesel	2009-2010
KENWORTH	T400A	CUMMINS M11 DIESEL	1994-1995	FREIGHTLINER	CLASSIC XL	MERCEDES BENZ MBE 4000 Diesel	2009-2010
KENWORTH	T450	CUMMINS L10 DIESEL	1990-1995	FREIGHTLINER	COLUMBIA	MERCEDES BENZ MBE 4000 Diesel	2008-2010
KENWORTH	T450	CUMMINS M11 DIESEL	1990-1999	FREIGHTLINER	COLUMBIA	MERCEDES-BENZ MBE 4000 DIESEL	2006-2007
KENWORTH	T450B	CUMMINS L10 DIESEL	1990-1991	FREIGHTLINER	FLD	MERCEDES BENZ MBE 4000 Diesel	2009-2010
KENWORTH	T600	CUMMINS 6 CIL, 14.0 L DIESEL	1991-1991	STERLING	A-LINE	MERCEDES-BENZ MBE 4000 DIESEL	2008-2008
KENWORTH	T600	CUMMINS L10 DIESEL	1990-1997	STERLING	L-LINE	MERCEDES-BENZ MBE 4000 DIESEL	2007-2007
KENWORTH	T600	CUMMINS N14 DIESEL	1992-1996	VOLKSWAGEN	17-280	MAN D0836 6.8L	2012-2014
KENWORTH	T600A	CUMMINS L10 DIESEL	1992-1995	VOLKSWAGEN	CONSTELLATION 24-280	MAN D0836 6.8L	2012-2014
KENWORTH	T800	CUMMINS 6 CIL, 14.0 L DIESEL	1991-1991	VOLKSWAGEN	CONSTELLATION 8-150 VOLKSBUS	MAN D0834 4.6L	2012-2014
KENWORTH	T800	CUMMINS L10 DIESEL	1990-1997	VOLKSWAGEN	8-150 WORKER	MAN D0834 4.6L	2012-2014
KENWORTH	T800	CUMMINS N14 DIESEL	1992-1996	VOLKSWAGEN	9-150 VOLKSBUS	MAN D0834 4.6L	2012-2014
VOLVO	AUTOCAR	CUMMINS N14 DIESEL	1999-2001	VOLKSWAGEN	9-150 WORKER	MAN D0834 4.6L	2012-2014
K080485				K080510			
FREIGHTLINER	FLC	CUMMINS L10 DIESEL	1990-1993	VOLVO	XPEDITOR	CUMMINS L10 DIESEL	1996-1996
FREIGHTLINER	FLD	CUMMINS L10 DIESEL	1990-1993	K080530			
KENWORTH	T2000	CUMMINS M11 DIESEL	1996-1996	FREIGHTLINER	CENTURY CLASS	CUMMINS ISM DIESEL	1999-1999
KENWORTH	T400	CUMMINS L10 DIESEL	1990-1997	FREIGHTLINER	CENTURY CLASS	CUMMINS M11 DIESEL	1999-1999
KENWORTH	T400	CUMMINS M11 DIESEL	1995-1997	FREIGHTLINER	FL112	CUMMINS ISM DIESEL	1999-1999
KENWORTH	T400A	CUMMINS L10 DIESEL	1993-1995	FREIGHTLINER	FLD	CUMMINS ISM DIESEL	1999-1999
KENWORTH	T400A	CUMMINS M11 DIESEL	1994-1995	FREIGHTLINER	FLD	CUMMINS M11 DIESEL	1999-1999
KENWORTH	T450	CUMMINS L10 DIESEL	1990-1995	VOLVO	XPEDITOR	CUMMINS L10 DIESEL	1996-1996
KENWORTH	T450	CUMMINS M11 DIESEL	1990-1999	K080537			
KENWORTH	T450B	CUMMINS L10 DIESEL	1992-1994	FREIGHTLINER	CENTURY CLASS	CUMMINS ISM DIESEL	1999-1999
KENWORTH	T600	CUMMINS L10 DIESEL	1990-1997	FREIGHTLINER	CENTURY CLASS	CUMMINS M11 DIESEL	1999-1999
KENWORTH	T600	CUMMINS M11 DIESEL	1995-1998	K080545			
KENWORTH	T600A	CUMMINS L10 DIESEL	1993-1995	STERLING	A-LINE	DETROIT DIESEL 6 CIL, 12.7 L DIESEL	2004-2004
KENWORTH	T800	CUMMINS L10 DIESEL	1990-1997	STERLING	A-LINE	DETROIT DIESEL 6 CIL, 14.0 L DIESEL	2004-2004
KENWORTH	T800	CUMMINS M11 DIESEL	1995-1998	STERLING	A-LINE	DETROIT DIESEL SERIE 60	2004-2004
KENWORTH	W900	CUMMINS ISM DIESEL	1999-1999	STERLING	A-LINE	MERCEDES-BENZ MBE 4000 DIESEL	2004-2006
K080491				STERLING	L-LINE	CATERPILLAR 3306 DIESEL	2000-2000
FREIGHTLINER	CENTURY CLASS	CUMMINS ISM DIESEL	1998-1998	STERLING	L-LINE	DETROIT DIESEL 6 CIL, 12.7 L DIESEL	2004-2004
FREIGHTLINER	CENTURY CLASS	CUMMINS M11 DIESEL	1997-1997	STERLING	L-LINE	DETROIT DIESEL 6 CIL, 14.0 L DIESEL	2004-2004
FREIGHTLINER	FL112	CUMMINS ISM DIESEL	1998-1998	STERLING	L-LINE	MERCEDES-BENZ MBE 4000 DIESEL	2003-2006
K080496				VOLVO	WCA SERIES	CUMMINS ISM DIESEL	1998-1998
FREIGHTLINER	CENTURY CLASS	CUMMINS M11 DIESEL	1996-1998	VOLVO	WCA SERIES	CUMMINS M11 DIESEL	1996-1997
FREIGHTLINER	FL112	CUMMINS M11 DIESEL	1996-1997	VOLVO	WG SERIES	CUMMINS L10 DIESEL	1996-1997
FREIGHTLINER	FLC	CUMMINS M11 DIESEL	1995-1997	VOLVO	WG SERIES	CUMMINS M11 DIESEL	1996-1996
FREIGHTLINER	FLD	CUMMINS M11 DIESEL	1997-1997	VOLVO	WIA SERIES	CUMMINS ISM DIESEL	1998-1999



MASTER SERVICIO PESADO 2014

BANDAS

MARCA	MODELO	MOTOR	AÑOS	MARCA	MODELO	MOTOR	AÑOS
VOLVO	WIA SERIES	CUMMINS L10 DIESEL	1997-1997	FREIGHTLINER	FLD	DETROIT DIESEL 6 CIL, 12.7 L DIESEL	2005-2008
VOLVO	WIA SERIES	CUMMINS M11 DIESEL	1996-1997	FREIGHTLINER	FLD	DETROIT DIESEL 6 CIL, 14.0 L DIESEL	2005-2007
VOLVO	XPEDITOR	CUMMINS L10 DIESEL	1996-1996	FREIGHTLINER	FLD	DETROIT DIESEL SERIE 60	2006-2006
K080550				INTERNATIONAL/NAVISTAR	9100I	CUMMINS ISM DIESEL	2000-2003
CHEVROLET	T6500	ISUZU 6HK1-TC DIESEL	2005-2007	INTERNATIONAL/NAVISTAR	9200I	CUMMINS ISM DIESEL	2000-2002
CHEVROLET	T7500	ISUZU 6HK1-TC DIESEL	2005-2007	INTERNATIONAL/NAVISTAR	9400I	CUMMINS ISM DIESEL	2000-2003
CHEVROLET	T8500	ISUZU 6HK1-TC DIESEL	2005-2007	INTERNATIONAL/NAVISTAR	9600	CUMMINS M11 DIESEL	1996-1996
HINO	1524 SERIE 500	HINO J08-ETE	2010-2013	INTERNATIONAL/NAVISTAR	9700	CUMMINS M11 DIESEL	1996-1996
HINO	1714 SERIE 500	HINO J80E-ETB	2010-2013	INTERNATIONAL/NAVISTAR	9800	CUMMINS M11 DIESEL	1997-1997
HINO	1727 SERIE 500	HINO J80E-ETB	2010-2013	INTERNATIONAL/NAVISTAR	9900I	CUMMINS ISM DIESEL	2000-2003
VOLVO	9300	B9	2004-2004	INTERNATIONAL/NAVISTAR	9900IX	CUMMINS ISM DIESEL	2000-2002
VOLVO	VNL	VOLVO D16 DIESEL	2008-2013	STERLING	A-LINE	DETROIT DIESEL 6 CIL, 11.1 L DIESEL	2001-2002
VOLVO	VNL	VOLVO VE D16 DIESEL	2006-2009	STERLING	A-LINE	DETROIT DIESEL 6 CIL, 12.7 L DIESEL	2001-2006
VOLVO	VNM	VOLVO D16 DIESEL	2008-2013	STERLING	A-LINE	DETROIT DIESEL 6 CIL, 14.0 L DIESEL	2005-2006
VOLVO	VNM	VOLVO VE D16 DIESEL	2006-2009	STERLING	A-LINE	DETROIT DIESEL SERIE 60	2002-2006
VOLVO	VT SERIES	VOLVO VE D16 DIESEL	2006-2009	STERLING	L-LINE	DETROIT DIESEL 6 CIL, 11.1 L DIESEL	2002-2002
K080558				STERLING	L-LINE	DETROIT DIESEL 6 CIL, 12.7 L DIESEL	2002-2007
VOLVO	VHD	VOLVO VE D12 DIESEL	2001-2002	STERLING	L-LINE	DETROIT DIESEL 6 CIL, 14.0 L DIESEL	2003-2007
K080560				STERLING	L-LINE	DETROIT DIESEL SERIE 60	2002-2006
FREIGHTLINER	CENTURY CLASS	DETROIT DIESEL SERIE 60	2001-2003	VOLVO	VHD	VOLVO VE D12 DIESEL	2007-2009
FREIGHTLINER	CENTURY CLASS	MERCEDES-BENZ MBE 4000 DIESEL	2001-2001	VOLVO	WCA SERIES	CUMMINS ISM DIESEL	1998-1998
INTERNATIONAL/NAVISTAR	8100	CUMMINS ISM DIESEL	1999-1999	VOLVO	WCA SERIES	CUMMINS M11 DIESEL	1996-1997
KENWORTH	K100	CUMMINS C Series 8.3 L DIESEL	1992-1993	VOLVO	WG SERIES	CUMMINS L10 DIESEL	1996-1997
MERCEDES BENZ	BUSS 320	BUSS 320	2002-2006	VOLVO	WG SERIES	CUMMINS M11 DIESEL	1996-1996
MERCEDES BENZ	BUSSCAR	MB 906	2002-2008	VOLVO	WG SERIES	VOLVO VE D12 DIESEL	1999-1999
VOLVO	XPEDITOR	CATERPILLAR 3306 DIESEL	1996-1996	VOLVO	WIA SERIES	CUMMINS ISM DIESEL	1998-1999
VOLVO	XPEDITOR	CUMMINS L10 DIESEL	1996-1996	VOLVO	WIA SERIES	CUMMINS L10 DIESEL	1997-1997
K080565				VOLVO	WIA SERIES	CUMMINS M11 DIESEL	1996-1997
FREIGHTLINER	CENTURY CLASS	DETROIT DIESEL 6 CIL, 11.1 L DIESEL	2001-2001	K080566			
FREIGHTLINER	CENTURY CLASS	DETROIT DIESEL 6 CIL, 12.7 L DIESEL	2004-2007	VOLVO	WG SERIES	VOLVO VE D12 DIESEL	1998-2001
FREIGHTLINER	CENTURY CLASS	DETROIT DIESEL 6 CIL, 12.7 L DIESEL	2001-2001	K080570			
FREIGHTLINER	CENTURY CLASS	DETROIT DIESEL 6 CIL, 14.0 L DIESEL	2004-2007	DINA	S-700	CUMMINS L10 DIESEL	1990-1997
FREIGHTLINER	CENTURY CLASS	DETROIT DIESEL SERIE 60	2005-2005	FREIGHTLINER	CENTURY CLASS	DETROIT DIESEL 6 CIL, 11.1 L DIESEL	2002-2003
FREIGHTLINER	CENTURY CLASS	MERCEDES-BENZ MBE 4000 DIESEL	2001-2001	FREIGHTLINER	CENTURY CLASS	DETROIT DIESEL 6 CIL, 11.1 L DIESEL	2001-2001
FREIGHTLINER	CLASSIC	DETROIT DIESEL 6 CIL, 12.7 L DIESEL	2005-2007	FREIGHTLINER	CENTURY CLASS	DETROIT DIESEL 6 CIL, 12.7 L DIESEL	2002-2003
FREIGHTLINER	CLASSIC	DETROIT DIESEL 6 CIL, 14.0 L DIESEL	2005-2007	FREIGHTLINER	CENTURY CLASS	DETROIT DIESEL 6 CIL, 12.7 L DIESEL	2001-2001
FREIGHTLINER	CLASSIC	DETROIT DIESEL SERIE 60	2005-2005	FREIGHTLINER	CENTURY CLASS	DETROIT DIESEL 6 CIL, 14.0 L DIESEL	2003-2003
FREIGHTLINER	CLASSIC XL	DETROIT DIESEL 6 CIL, 12.7 L DIESEL	2005-2007	FREIGHTLINER	CENTURY CLASS	DETROIT DIESEL SERIE 60	2002-2003
FREIGHTLINER	CLASSIC XL	DETROIT DIESEL 6 CIL, 14.0 L DIESEL	2005-2007	FREIGHTLINER	CENTURY CLASS	DETROIT DIESEL SERIE 60	2001-2003
FREIGHTLINER	COLUMBIA	DETROIT DIESEL 6 CIL, 12.7 L DIESEL	2004-2009	FREIGHTLINER	CLASSIC	DETROIT DIESEL 6 CIL, 12.7 L DIESEL	2004-2004
FREIGHTLINER	COLUMBIA	DETROIT DIESEL 6 CIL, 14.0 L DIESEL	2004-2007	FREIGHTLINER	CLASSIC	DETROIT DIESEL 6 CIL, 12.7 L DIESEL	2003-2003
FREIGHTLINER	COLUMBIA	DETROIT DIESEL SERIE 60	2004-2006	FREIGHTLINER	CLASSIC	DETROIT DIESEL 6 CIL, 14.0 L DIESEL	2004-2008
FREIGHTLINER	CORONADO	DETROIT DIESEL 6 CIL, 12.7 L DIESEL	2002-2008	FREIGHTLINER	CLASSIC	DETROIT DIESEL 6 CIL, 14.0 L DIESEL	2003-2003
FREIGHTLINER	CORONADO	DETROIT DIESEL 6 CIL, 14.0 L DIESEL	2003-2010	FREIGHTLINER	CLASSIC XL	DETROIT DIESEL 6 CIL, 12.7 L DIESEL	2004-2004
FREIGHTLINER	CORONADO	DETROIT DIESEL SERIE 60	2004-2006	FREIGHTLINER	CLASSIC XL	DETROIT DIESEL 6 CIL, 12.7 L DIESEL	2003-2003



MASTER SERVICIO PESADO 2014

BANDAS

MARCA	MODELO	MOTOR	AÑOS	MARCA	MODELO	MOTOR	AÑOS
FREIGHTLINER	CLASSIC XL	DETROIT DIESEL 6 CIL, 14.0 L DIESEL	2004-2008	FREIGHTLINER	ARGOSY	DETROIT DIESEL 6 CIL, 11.1 L DIESEL	2000-2003
FREIGHTLINER	CLASSIC XL	DETROIT DIESEL 6 CIL, 14.0 L DIESEL	2003-2003	FREIGHTLINER	ARGOSY	DETROIT DIESEL 6 CIL, 12.7 L DIESEL	2000-2008
FREIGHTLINER	COLUMBIA	DETROIT DIESEL 6 CIL, 11.1 L DIESEL	2000-2001	FREIGHTLINER	ARGOSY	DETROIT DIESEL 6 CIL, 14.0 L DIESEL	2001-2008
FREIGHTLINER	COLUMBIA	DETROIT DIESEL 6 CIL, 12.7 L DIESEL	2000-2003	FREIGHTLINER	CASCADIA	DETROIT DIESEL 6 CIL, 14.0 L DIESEL	2008-2010
FREIGHTLINER	COLUMBIA	DETROIT DIESEL 6 CIL, 14.0 L DIESEL	2008-2010	FREIGHTLINER	CENTURY CLASS	DETROIT DIESEL 6 CIL, 11.1 L DIESEL	1999-2000
FREIGHTLINER	COLUMBIA	DETROIT DIESEL 6 CIL, 14.0 L DIESEL	2002-2003	FREIGHTLINER	CENTURY CLASS	DETROIT DIESEL 6 CIL, 12.7 L DIESEL	1999-2000
FREIGHTLINER	COLUMBIA	DETROIT DIESEL SERIE 60	2001-2001	FREIGHTLINER	CENTURY CLASS	DETROIT DIESEL SERIE 60	1999-2000
FREIGHTLINER	COLUMBIA	DETROIT DIESEL SERIE 60	2002-2003	FREIGHTLINER	CLASSIC	DETROIT DIESEL 6 CIL, 11.1 L DIESEL	2001-2002
FREIGHTLINER	FLC	CUMMINS L10 DIESEL	1990-1993	FREIGHTLINER	CLASSIC	DETROIT DIESEL 6 CIL, 12.7 L DIESEL	2001-2003
FREIGHTLINER	FLD	CUMMINS ISM DIESEL	1998-1998	FREIGHTLINER	CLASSIC	DETROIT DIESEL 6 CIL, 14.0 L DIESEL	2003-2003
FREIGHTLINER	FLD	CUMMINS L10 DIESEL	1990-1993	FREIGHTLINER	CLASSIC XL	DETROIT DIESEL 6 CIL, 11.1 L DIESEL	2001-2002
FREIGHTLINER	FLD	CUMMINS M11 DIESEL	1995-1998	FREIGHTLINER	CLASSIC XL	DETROIT DIESEL 6 CIL, 12.7 L DIESEL	2001-2003
FREIGHTLINER	FLD	DETROIT DIESEL 6 CIL, 12.7 L DIESEL	2004-2004	FREIGHTLINER	CLASSIC XL	DETROIT DIESEL 6 CIL, 14.0 L DIESEL	2001-2003
FREIGHTLINER	FLD	DETROIT DIESEL 6 CIL, 12.7 L DIESEL	2003-2003	FREIGHTLINER	COLUMBIA	DETROIT DIESEL 6 CIL, 11.1 L DIESEL	2000-2001
FREIGHTLINER	FLD	DETROIT DIESEL 6 CIL, 14.0 L DIESEL	2004-2008	FREIGHTLINER	COLUMBIA	DETROIT DIESEL 6 CIL, 12.7 L DIESEL	2000-2003
FREIGHTLINER	FLD	DETROIT DIESEL 6 CIL, 14.0 L DIESEL	2003-2003	FREIGHTLINER	COLUMBIA	DETROIT DIESEL 6 CIL, 14.0 L DIESEL	2002-2003
FREIGHTLINER	FLD	DETROIT DIESEL 6 CIL, 14.0 L DIESEL	2009-2010	FREIGHTLINER	COLUMBIA	DETROIT DIESEL SERIE 60	2002-2003
FREIGHTLINER	FLD	DETROIT DIESEL SERIE 60	2004-2004	FREIGHTLINER	FLD	DETROIT DIESEL 6 CIL, 11.1 L DIESEL	2000-2000
FREIGHTLINER	FLD	DETROIT DIESEL SERIE 60	2003-2003	FREIGHTLINER	FLD	DETROIT DIESEL 6 CIL, 11.1 L DIESEL	2001-2002
INTERNATIONAL/NAVISTAR	8100	CUMMINS ISM DIESEL	1999-1999	FREIGHTLINER	FLD	DETROIT DIESEL 6 CIL, 12.7 L DIESEL	2000-2000
INTERNATIONAL/NAVISTAR	8200	CUMMINS L10 DIESEL	1995-1997	FREIGHTLINER	FLD	DETROIT DIESEL 6 CIL, 12.7 L DIESEL	2001-2003
IRIZAR	INTERCENTURY	906	2003-2006	FREIGHTLINER	FLD	DETROIT DIESEL 6 CIL, 14.0 L DIESEL	2009-2010
MERCEDES BENZ	ALEGRO	MB 1623	2004-2010	FREIGHTLINER	FLD	DETROIT DIESEL 6 CIL, 14.0 L DIESEL	2001-2003
MERCEDES BENZ	MARCOPOLO ANDARE	MB 1628	2000-2005	FREIGHTLINER	FLD	DETROIT DIESEL SERIE 60	2000-2000
MERCEDES BENZ	MARCOPOLO ANDARE	O-500-1728	2005-2006	FREIGHTLINER	FLD	DETROIT DIESEL SERIE 60	2001-2001
STERLING	L-LINE	DETROIT DIESEL 6 CIL, 12.7 L DIESEL	2008-2008	FREIGHTLINER	FLD	DETROIT DIESEL SERIE 60	2002-2003
STERLING	L-LINE	DETROIT DIESEL 6 CIL, 14.0 L DIESEL	2008-2008	FREIGHTLINER	FLD120	DETROIT DIESEL SERIE 60	2001-2001
K080575				KENWORTH	T2000	DETROIT DIESEL 6 CIL, 11.1 L DIESEL	2000-2000
FREIGHTLINER	BUSINESS CLASS M2	MERCEDES-BENZ MBE 4000 DIESEL	2004-2004	KENWORTH	T2000	DETROIT DIESEL 6 CIL, 12.7 L DIESEL	2000-2000
FREIGHTLINER	CENTURY CLASS	MERCEDES-BENZ MBE 4000 DIESEL	2005-2005	KENWORTH	T2000	DETROIT DIESEL SERIE 60	2000-2000
FREIGHTLINER	CLASSIC	DETROIT DIESEL 6 CIL, 11.1 L DIESEL	2001-2002	KENWORTH	T800	DETROIT DIESEL 6 CIL, 11.1 L DIESEL	2000-2001
FREIGHTLINER	CLASSIC	DETROIT DIESEL 6 CIL, 12.7 L DIESEL	2001-2002	KENWORTH	T800	DETROIT DIESEL 6 CIL, 12.7 L DIESEL	2000-2001
FREIGHTLINER	CLASSIC XL	DETROIT DIESEL 6 CIL, 11.1 L DIESEL	2001-2002	KENWORTH	W900	DETROIT DIESEL 6 CIL, 11.1 L DIESEL	2000-2001
FREIGHTLINER	CLASSIC XL	DETROIT DIESEL 6 CIL, 12.7 L DIESEL	2001-2002	KENWORTH	W900	DETROIT DIESEL 6 CIL, 12.7 L DIESEL	2000-2001
FREIGHTLINER	CLASSIC XL	DETROIT DIESEL 6 CIL, 14.0 L DIESEL	2001-2001	KENWORTH	W900	DETROIT DIESEL SERIE 60	2000-2000
FREIGHTLINER	COLUMBIA	MERCEDES-BENZ MBE 4000 DIESEL	2005-2005	K080585			
FREIGHTLINER	FLD	DETROIT DIESEL 6 CIL, 11.1 L DIESEL	2001-2002	FREIGHTLINER	ARGOSY	DETROIT DIESEL 6 CIL, 11.1 L DIESEL	1999-1999
FREIGHTLINER	FLD	DETROIT DIESEL 6 CIL, 12.7 L DIESEL	2001-2002	FREIGHTLINER	ARGOSY	DETROIT DIESEL 6 CIL, 12.7 L DIESEL	1999-1999
FREIGHTLINER	FLD	DETROIT DIESEL 6 CIL, 14.0 L DIESEL	2001-2002	FREIGHTLINER	FLC	CUMMINS L10 DIESEL	1990-1993
FREIGHTLINER	FLD	DETROIT DIESEL SERIE 60	2001-2001	FREIGHTLINER	FLD	CUMMINS L10 DIESEL	1990-1993
FREIGHTLINER	FLD	DETROIT DIESEL SERIE 60	2002-2002	FREIGHTLINER	FLD120	CUMMINS M11 DIESEL	1994-1994
FREIGHTLINER	FLD120	CUMMINS M11 DIESEL	1995-1996	INTERNATIONAL/NAVISTAR	5000	CUMMINS L10 DIESEL	1990-1994
KENWORTH	K300	CUMMINS C Series 8.3 L DIESEL	1993-1997	INTERNATIONAL/NAVISTAR	PAYSTAR	CUMMINS L10 DIESEL	1990-1994
VOLVO	WIA SERIES	VOLVO VE D12 DIESEL	1996-1997	MERCEDES BENZ	MARCOPOLO ANDARE	MERCEDES-BENZ 960	2001-2001
K080580				VOLVO	XPEDITOR	CUMMINS L10 DIESEL	1996-1996



MASTER SERVICIO PESADO 2014

BANDAS

MARCA	MODELO	MOTOR	AÑOS	MARCA	MODELO	MOTOR	AÑOS
K080586				MACK	CXU SERIES	MACK MP8 DIESEL	2008-2008
VOLVO	9700	B13	2012-2014	MACK	GRANITE	MACK MP8 DIESEL	2011-2013
K080590				MACK	GU SERIES	MACK MP8 DIESEL	2008-2010
FREIGHTLINER	FLD120	CUMMINS ISM 370	2000-2000	VOLVO	VNL	VOLVO D13 DIESEL	2008-2014
KENWORTH	K100	CUMMINS C Series 8.3 L DIESEL	1992-1993	VOLVO	VNM	VOLVO D13 DIESEL	2008-2014
KENWORTH	K300	CUMMINS C Series 8.3 L DIESEL	1993-1997	K080635			
MACK	CXU SERIES	MACK MP8 DIESEL	2008-2010	VOLKSWAGEN	15-190 WORKER	CUMMINS Interact 5.9 DIESEL (EURO III)	2005-2011
MERCEDES BENZ	BOXER	MB 904	2005-2010	VOLKSWAGEN	17-210 VOLKSBUS	MWM de 6.2 DIESEL ELECTRONICO	2005-2011
MERCEDES BENZ	TORINO	MB 906	2005-2010	VOLKSWAGEN	17-250 WORKER	CUMMINS Interact 5.9 DIESEL (EURO III)	2005-2011
K080605				VOLKSWAGEN	24-250 WORKER	CUMMINS INTERACT 5.9 DIESEL (EURO III)	2005-2011
INTERNATIONAL/NAVISTAR	5000	CUMMINS ISM DIESEL	1998-2000	VOLKSWAGEN	8-150 VOLKSBUS	CUMMINS Interact 3.9 DIESEL (EURO II)	2005-2011
INTERNATIONAL/NAVISTAR	5000	CUMMINS L10 DIESEL	1990-1998	VOLKSWAGEN	8-150 WORKER	CUMMINS INTERACT 3.9 DIESEL (EURO III)	2005-2011
INTERNATIONAL/NAVISTAR	5000	CUMMINS M11 DIESEL	1996-1999	K080645			
INTERNATIONAL/NAVISTAR	8100	CUMMINS ISM DIESEL	1998-2003	INTERNATIONAL/NAVISTAR	5000	CUMMINS M11 DIESEL	2000-2000
INTERNATIONAL/NAVISTAR	8100	CUMMINS L10 DIESEL	1997-1997	INTERNATIONAL/NAVISTAR	5500I	CUMMINS ISM DIESEL	2000-2000
INTERNATIONAL/NAVISTAR	8100	CUMMINS M11 DIESEL	1995-1997	INTERNATIONAL/NAVISTAR	5600I	CUMMINS ISM DIESEL	2000-2000
INTERNATIONAL/NAVISTAR	8200	CUMMINS ISM DIESEL	1998-1998	INTERNATIONAL/NAVISTAR	5900I	CUMMINS ISM DIESEL	2000-2000
INTERNATIONAL/NAVISTAR	8200	CUMMINS M11 DIESEL	1995-1997	INTERNATIONAL/NAVISTAR	PAYSTAR	CUMMINS M11 DIESEL	2000-2000
INTERNATIONAL/NAVISTAR	9200	CUMMINS M11 DIESEL	1995-1998	KENWORTH	T2000	CATERPILLAR C10 DIESEL	1997-1999
INTERNATIONAL/NAVISTAR	9300	CUMMINS M11 DIESEL	1996-1997	KENWORTH	T2000	CATERPILLAR C12 DIESEL	1997-1999
INTERNATIONAL/NAVISTAR	9400	CUMMINS M11 DIESEL	1996-1997	VOLVO	AUTOCAR	CUMMINS ISM DIESEL	2000-2001
INTERNATIONAL/NAVISTAR	PAYSTAR	CUMMINS L10 DIESEL	1990-1997	K080660			
INTERNATIONAL/NAVISTAR	PAYSTAR	CUMMINS M11 DIESEL	1996-1999	STERLING	L-LINE	MERCEDES-BENZ MBE 4000 DIESEL	2007-2007
K080610				K080670			
FREIGHTLINER	FLD	CUMMINS ISM DIESEL	1999-1999	VOLVO	AUTOCAR	DETROIT DIESEL 6 CIL, 11.1 L DIESEL	1998-1998
FREIGHTLINER	FLD	CUMMINS M11 DIESEL	1999-1999	VOLVO	AUTOCAR	DETROIT DIESEL 6 CIL, 12.7 L DIESEL	1998-1998
VOLVO	AUTOCAR	CUMMINS ISM DIESEL	1999-1999	VOLVO	VNL	DETROIT DIESEL 6 CIL, 11.1 L DIESEL	1998-2001
VOLVO	VNL	CUMMINS ISM DIESEL	2001-2001	VOLVO	VNL	DETROIT DIESEL 6 CIL, 12.7 L DIESEL	1998-2001
VOLVO	WG SERIES	CUMMINS ISM DIESEL	2000-2001	VOLVO	VNL 64T	DETROIT DIESEL SERIE 60	1999-2000
K080615				VOLVO	VNM	DETROIT DIESEL SERIE 60	1998-2000
DINA	S-600	CUMMINS 8.3 L DIESEL	1990-1997	VOLVO	XPEDITOR	CUMMINS C Series 8.3 L DIESEL	1996-1996
FREIGHTLINER	BUSINESS CLASS M2	MERCEDES-BENZ MBE 900 DIESEL	2006-2007	VOLVO	XPEDITOR	CUMMINS C Series 8.3 L DIESEL	1996-1996
INTERNATIONAL/NAVISTAR	5000	CUMMINS L10 DIESEL	1990-1994	K080672			
INTERNATIONAL/NAVISTAR	PAYSTAR	CUMMINS L10 DIESEL	1990-1994	FREIGHTLINER	CENTURY CLASS	MERCEDES-BENZ MBE 4000 DIESEL	2004-2004
K080623				FREIGHTLINER	COLUMBIA	MERCEDES-BENZ MBE 4000 DIESEL	2003-2004
VOLVO	VNL	CUMMINS ISM DIESEL	1998-1998	FREIGHTLINER	FL112	MERCEDES-BENZ MBE 4000 DIESEL	2003-2004
VOLVO	VNL	CUMMINS M11 DIESEL	1997-1997	K080675			
VOLVO	VNM	CUMMINS M11 DIESEL	1997-1998	KENWORTH	C500	CATERPILLAR 3176 DIESEL	1992-1994
K080630				KENWORTH	K300	CUMMINS B Series 5.9 L DIESEL	1995-1996
INTERNATIONAL/NAVISTAR	5000	CUMMINS L10 DIESEL	1990-1991	KENWORTH	K300	CUMMINS ISB DIESEL	2000-2001
INTERNATIONAL/NAVISTAR	PAYSTAR	CUMMINS L10 DIESEL	1990-1991	KENWORTH	T400	CATERPILLAR 3176 DIESEL	1991-1995
MACK	CHU SERIES	MACK MP8 DIESEL	2008-2010	KENWORTH	T450	CATERPILLAR 3176 DIESEL	1991-1995
MACK	CTP SERIES	MACK MP7 DIESEL	2007-2007	KENWORTH	T600	CATERPILLAR 3176 DIESEL	1991-1995
MACK	CXP SERIES	MACK MP7 DIESEL	2006-2007	KENWORTH	T800	CATERPILLAR 3176 DIESEL	1991-1995
MACK	CXU SERIES	MACK MP8 DIESEL	2009-2010	K080677			



MASTER SERVICIO PESADO 2014

BANDAS

MARCA	MODELO	MOTOR	AÑOS	MARCA	MODELO	MOTOR	AÑOS
FREIGHTLINER	BUSINESS CLASS M2	MERCEDES-BENZ MBE 900 DIESEL	2002-2004	INTERNATIONAL/NAVISTAR	BE	INTERNATIONAL/NAVISTAR VT365 DIESEL	2007-2008
K080680				INTERNATIONAL/NAVISTAR	CE	INTERNATIONAL/NAVISTAR VT365 DIESEL	2005-2007
FREIGHTLINER	CENTURY CLASS	CATERPILLAR C10 DIESEL	1997-1997	KENWORTH	T600	CUMMINS ISM DIESEL	2004-2004
FREIGHTLINER	CENTURY CLASS	CATERPILLAR C12 DIESEL	1997-1997	KENWORTH	T800	CUMMINS ISM DIESEL	2004-2007
FREIGHTLINER	FLC	CATERPILLAR 3176 DIESEL	1991-1996	KENWORTH	W900	CUMMINS ISM DIESEL	2003-2005
FREIGHTLINER	FLD	CATERPILLAR 3176 DIESEL	1991-1996	KENWORTH	W900	CUMMINS ISM DIESEL	2006-2006
FREIGHTLINER	FLD	CATERPILLAR C10 DIESEL	1997-1997	STERLING	ACTERRA	CATERPILLAR 3126 DIESEL	2003-2003
FREIGHTLINER	FLD	CATERPILLAR C12 DIESEL	1996-1997	STERLING	ACTERRA	CATERPILLAR 3126 DIESEL	2001-2004
KENWORTH	C500	CATERPILLAR 3176 DIESEL	1992-1994	STERLING	ACTERRA	CATERPILLAR C7 DIESEL	2004-2004
KENWORTH	T400	CATERPILLAR 3176 DIESEL	1991-1995	STERLING	ACTERRA	CATERPILLAR C7 DIESEL	2004-2004
KENWORTH	T450	CATERPILLAR 3176 DIESEL	1991-1995	K080708			
KENWORTH	T600	CATERPILLAR 3176 DIESEL	1991-1995	FREIGHTLINER	ARGOSY	CUMMINS ISM DIESEL	2000-2000
KENWORTH	T800	CATERPILLAR 3176 DIESEL	1991-1995	INTERNATIONAL/NAVISTAR	8100	CATERPILLAR 3176 DIESEL	1995-1997
K080683				INTERNATIONAL/NAVISTAR	PROSTAR SERIES	CUMMINS ISX DIESEL	2007-2008
KENWORTH	T800	CUMMINS ISM DIESEL	2008-2014	KENWORTH	T600	CUMMINS ISM DIESEL	2001-2002
K080685				KENWORTH	T800	CUMMINS ISM DIESEL	1999-2002
INTERNATIONAL/NAVISTAR	4400	INTERNATIONAL/NAVISTAR 530 DIESEL	2002-2005	KENWORTH	T800	CUMMINS M11 DIESEL	2000-2000
INTERNATIONAL/NAVISTAR	8500	INTERNATIONAL/NAVISTAR 530 DIESEL	2002-2005	KENWORTH	W900	CUMMINS ISM DIESEL	2002-2002
KENWORTH	K100	CUMMINS C Series 8.3 L DIESEL	1992-1993	STERLING	ACTERRA	CUMMINS ISC DIESEL	2005-2007
K080690				VOLKSWAGEN	17-210 VOLKSBUS	MWM de 6.2 DIESEL ELECTRONICO	2005-2011
FREIGHTLINER	FLC	CUMMINS L10 DIESEL	1990-1993	VOLKSWAGEN	24-250 WORKER	CUMMINS INTERACT 5.9 DIESEL (EURO III)	2005-2011
FREIGHTLINER	FLD	CUMMINS L10 DIESEL	1990-1993	K080716			
INTERNATIONAL/NAVISTAR	3800	INTERNATIONAL/NAVISTAR DT466	2002-2002	FREIGHTLINER	BUSINESS CLASS M2	CUMMINS ISC DIESEL	2004-2004
INTERNATIONAL/NAVISTAR	CE	INTERNATIONAL/NAVISTAR DT466	2003-2004	INTERNATIONAL/NAVISTAR	4700	INTERNATIONAL/NAVISTAR 530 DIESEL	1999-2002
INTERNATIONAL/NAVISTAR	CONVENTIONAL IC	INTERNATIONAL/NAVISTAR DT466	2002-2003	INTERNATIONAL/NAVISTAR	4800	INTERNATIONAL/NAVISTAR 530 DIESEL	2002-2002
KENWORTH	T600	CATERPILLAR C10 DIESEL	1996-1996	INTERNATIONAL/NAVISTAR	4900	INTERNATIONAL/NAVISTAR 530 DIESEL	1995-2002
K080694				KENWORTH	T800	CUMMINS ISL DIESEL	2001-2005
INTERNATIONAL/NAVISTAR	8600	CUMMINS ISM DIESEL	2003-2007	KENWORTH	T800	CUMMINS ISM DIESEL	2003-2003
INTERNATIONAL/NAVISTAR	TRANSTAR 8600	CUMMINS ISM DIESEL	2008-2008	KENWORTH	W900	CUMMINS ISC DIESEL	2003-2004
STERLING	ACTERRA	CATERPILLAR C7 DIESEL	2006-2007	K080720			
VOLVO	VNL	CATERPILLAR 3406 DIESEL	1999-1999	FORD	F-600	CUMMINS C Series 8.3 L DIESEL	1994-1994
VOLVO	VNM	CATERPILLAR 3406 DIESEL	1999-1999	FORD	F-600	CUMMINS C Series 8.3 L DIESEL	1993-1993
K080700				INTERNATIONAL/NAVISTAR	8100	CATERPILLAR 3176 DIESEL	1995-1997
DINA	DORADO	DETROIT DIESEL SERIE 60, 12.7 L	1992-1996	INTERNATIONAL/NAVISTAR	8100	INTERNATIONAL/NAVISTAR 530 DIESEL	1996-1997
INTERNATIONAL/NAVISTAR	4300	INTERNATIONAL/NAVISTAR DT466	2002-2002	INTERNATIONAL/NAVISTAR	8200	INTERNATIONAL/NAVISTAR 530 DIESEL	1996-1997
INTERNATIONAL/NAVISTAR	4400	INTERNATIONAL/NAVISTAR DT466	2002-2002	INTERNATIONAL/NAVISTAR	8200	INTERNATIONAL/NAVISTAR DT466	1997-1997
KENWORTH	C500	CATERPILLAR 3176 DIESEL	1992-1994	INTERNATIONAL/NAVISTAR	9200	CATERPILLAR 3176 DIESEL	1995-1995
KENWORTH	T400	CATERPILLAR 3176 DIESEL	1991-1995	INTERNATIONAL/NAVISTAR	9200	CATERPILLAR C10 DIESEL	1996-1996
KENWORTH	T450	CATERPILLAR 3176 DIESEL	1991-1995	INTERNATIONAL/NAVISTAR	9200	CATERPILLAR C12 DIESEL	1996-1996
KENWORTH	T600	CATERPILLAR 3176 DIESEL	1991-1995	INTERNATIONAL/NAVISTAR	9300	CATERPILLAR 3176 DIESEL	1995-1995
KENWORTH	T800	CATERPILLAR 3176 DIESEL	1991-1995	INTERNATIONAL/NAVISTAR	9300	CATERPILLAR C10 DIESEL	1996-1996
K080702				INTERNATIONAL/NAVISTAR	9300	CATERPILLAR C12 DIESEL	1996-1996
INTERNATIONAL/NAVISTAR	4300	INTERNATIONAL/NAVISTAR DT466	2003-2004	INTERNATIONAL/NAVISTAR	9400	CATERPILLAR 3176 DIESEL	1995-1997
INTERNATIONAL/NAVISTAR	4400	INTERNATIONAL/NAVISTAR DT466	2003-2005	INTERNATIONAL/NAVISTAR	9400	CATERPILLAR C10 DIESEL	1996-1996
INTERNATIONAL/NAVISTAR	BE	INTERNATIONAL/NAVISTAR MAXXFORCE 7 DIESEL	2008-2008	INTERNATIONAL/NAVISTAR	9400	CATERPILLAR C12 DIESEL	1996-1996



MASTER SERVICIO PESADO 2014

BANDAS

MARCA	MODELO	MOTOR	AÑOS	MARCA	MODELO	MOTOR	AÑOS
KENWORTH	T300	CUMMINS ISC DIESEL	2005-2005	STERLING	L-LINE	CUMMINS ISC DIESEL	2003-2003
K080723				STERLING	TORTON	CUMMINS ISB DIESEL	2000-2000
INTERNATIONAL/NAVISTAR	DURASTAR 4300	INTERNATIONAL/NAVISTAR MAXXFORCE DT DIESEL	2012-2012	K080733			
K080726				FREIGHTLINER	FLC	CATERPILLAR 3176 DIESEL	1991-1996
CHEVROLET	T6500	ISUZU 6HK1-TC DIESEL	2005-2008	FREIGHTLINER	FLD	CATERPILLAR 3176 DIESEL	1991-1996
CHEVROLET	T7500	ISUZU 6HK1-TC DIESEL	2005-2008	INTERNATIONAL/NAVISTAR	9100	CATERPILLAR C10 DIESEL	1998-1999
CHEVROLET	T8500	ISUZU 6HK1-TC DIESEL	2005-2008	INTERNATIONAL/NAVISTAR	9100	CATERPILLAR C12 DIESEL	1998-1999
FORD	F-650 SUPER DUTY	CUMMINS ISB DIESEL	2001-2004	INTERNATIONAL/NAVISTAR	9100I	CATERPILLAR C10 DIESEL	2000-2003
FORD	F-650 SUPER DUTY	CUMMINS ISB DIESEL	2000-2000	INTERNATIONAL/NAVISTAR	9100I	CATERPILLAR C12 DIESEL	2000-2003
FORD	F-750 SUPER DUTY	CUMMINS ISB DIESEL	2001-2004	INTERNATIONAL/NAVISTAR	9200	CATERPILLAR 3176 DIESEL	1995-1995
FORD	F-750 SUPER DUTY	CUMMINS ISB DIESEL	2000-2000	INTERNATIONAL/NAVISTAR	9200	CATERPILLAR C10 DIESEL	1997-1999
INTERNATIONAL/NAVISTAR	3800	INTERNATIONAL/NAVISTAR DT466	2000-2001	INTERNATIONAL/NAVISTAR	9200	CATERPILLAR C12 DIESEL	1997-1999
INTERNATIONAL/NAVISTAR	4700	INTERNATIONAL/NAVISTAR DT466	1995-2002	INTERNATIONAL/NAVISTAR	9200I	CATERPILLAR C10 DIESEL	2000-2003
INTERNATIONAL/NAVISTAR	4800	INTERNATIONAL/NAVISTAR DT466	1995-2003	INTERNATIONAL/NAVISTAR	9200I	CATERPILLAR C12 DIESEL	2000-2003
INTERNATIONAL/NAVISTAR	4900	INTERNATIONAL/NAVISTAR DT466	1995-2002	INTERNATIONAL/NAVISTAR	9300	CATERPILLAR 3176 DIESEL	1995-1995
INTERNATIONAL/NAVISTAR	7100	INTERNATIONAL/NAVISTAR DT466	1995-1995	INTERNATIONAL/NAVISTAR	9300	CATERPILLAR C10 DIESEL	1997-1998
INTERNATIONAL/NAVISTAR	CE	INTERNATIONAL/NAVISTAR DT466	2006-2008	INTERNATIONAL/NAVISTAR	9300	CATERPILLAR C12 DIESEL	1997-1998
INTERNATIONAL/NAVISTAR	CE	INTERNATIONAL/NAVISTAR DT466	2005-2005	INTERNATIONAL/NAVISTAR	9400	CATERPILLAR 3176 DIESEL	1995-1997
INTERNATIONAL/NAVISTAR	CE	INTERNATIONAL/NAVISTAR MAXXFORCE DT DIESEL	2008-2008	INTERNATIONAL/NAVISTAR	9400	CATERPILLAR C10 DIESEL	1997-1999
INTERNATIONAL/NAVISTAR	FE	INTERNATIONAL/NAVISTAR DT466	2002-2004	INTERNATIONAL/NAVISTAR	9400	CATERPILLAR C12 DIESEL	1997-1999
STERLING	L-LINE	CUMMINS ISB DIESEL	2000-2000	INTERNATIONAL/NAVISTAR	9400I	CATERPILLAR C10 DIESEL	2000-2002
K080730				INTERNATIONAL/NAVISTAR	9400I	CATERPILLAR C12 DIESEL	2000-2003
DINA	102 F	CUMMINS ISB	2008-2009	INTERNATIONAL/NAVISTAR	9900	CATERPILLAR C10 DIESEL	1999-1999
DINA	104-R	CUMMINS ISB	2008-2009	INTERNATIONAL/NAVISTAR	9900	CATERPILLAR C12 DIESEL	1999-1999
DINA	104-SF	CUMMINS ISB	2008-2009	INTERNATIONAL/NAVISTAR	9900I	CATERPILLAR C10 DIESEL	2000-2002
DINA	94 F	CUMMINS ISB	2008-2008	INTERNATIONAL/NAVISTAR	9900I	CATERPILLAR C12 DIESEL	2000-2003
DINA	CITUS	DETROIT DIESEL SERIE 60, 12.7 L	1994-1998	INTERNATIONAL/NAVISTAR	9900IX	CATERPILLAR C10 DIESEL	2000-2002
DINA	URBANO	CATERPILLAR 3126 DIESEL	1996-2000	INTERNATIONAL/NAVISTAR	9900IX	CATERPILLAR C12 DIESEL	2000-2003
FREIGHTLINER	ARGOSY	CUMMINS ISM DIESEL	1999-1999	IRIZAR	MAN AUTOMATICO	MAN PANORAMICO	2007-2010
FREIGHTLINER	CENTURY CLASS	CUMMINS ISM DIESEL	1998-2001	IRIZAR	MAN PANORAMICO	MAN PANORAMICO	2007-2010
FREIGHTLINER	CENTURY CLASS	CUMMINS M11 DIESEL	2000-2000	STERLING	MAN PANORAMICO L-LINE	CUMMINS ISC DIESEL	2000-2001
FREIGHTLINER	COLUMBIA	CUMMINS ISM DIESEL	2007-2007	K080734			
FREIGHTLINER	COLUMBIA	CUMMINS ISM DIESEL	2002-2003	STERLING	ACTERRA	CATERPILLAR C7 DIESEL	2005-2005
FREIGHTLINER	FL112	CUMMINS ISM DIESEL	2001-2003	K080738			
FREIGHTLINER	FL112	CUMMINS ISM DIESEL	2000-2000	INTERNATIONAL/NAVISTAR	4700	INTERNATIONAL/NAVISTAR DT466	1995-2002
INTERNATIONAL/NAVISTAR	3800	INTERNATIONAL/NAVISTAR DT466	1998-1999	INTERNATIONAL/NAVISTAR	4800	INTERNATIONAL/NAVISTAR DT466	1995-2003
INTERNATIONAL/NAVISTAR	4700	INTERNATIONAL/NAVISTAR DT466	1995-2002	INTERNATIONAL/NAVISTAR	4900	INTERNATIONAL/NAVISTAR DT466	1995-2002
INTERNATIONAL/NAVISTAR	4800	INTERNATIONAL/NAVISTAR DT466	1995-2003	INTERNATIONAL/NAVISTAR	7100	INTERNATIONAL/NAVISTAR DT466	1995-1995
INTERNATIONAL/NAVISTAR	4900	INTERNATIONAL/NAVISTAR DT466	1995-2002	INTERNATIONAL/NAVISTAR	9200	CATERPILLAR 3176 DIESEL	1995-1995
INTERNATIONAL/NAVISTAR	7100	INTERNATIONAL/NAVISTAR DT466	1995-1995	INTERNATIONAL/NAVISTAR	9300	CATERPILLAR 3176 DIESEL	1995-1995
INTERNATIONAL/NAVISTAR	8100	INTERNATIONAL/NAVISTAR 530 DIESEL	1995-1997	INTERNATIONAL/NAVISTAR	9400	CATERPILLAR 3176 DIESEL	1995-1997
INTERNATIONAL/NAVISTAR	8100	INTERNATIONAL/NAVISTAR DT466	1996-1997	K080740			
INTERNATIONAL/NAVISTAR	8100	INTERNATIONAL/NAVISTAR DT466	1995-1995	FREIGHTLINER	FLC	CATERPILLAR 3176 DIESEL	1991-1996
INTERNATIONAL/NAVISTAR	8200	INTERNATIONAL/NAVISTAR 530 DIESEL	1996-1997	FREIGHTLINER	FLD	CATERPILLAR 3176 DIESEL	1991-1996
INTERNATIONAL/NAVISTAR	8200	INTERNATIONAL/NAVISTAR DT466	1997-1997	INTERNATIONAL/NAVISTAR	3300	INTERNATIONAL/NAVISTAR DT466	2005-2005



MASTER SERVICIO PESADO 2014

BANDAS

MARCA	MODELO	MOTOR	AÑOS	MARCA	MODELO	MOTOR	AÑOS
INTERNATIONAL/NAVISTAR	4700	INTERNATIONAL/NAVISTAR DT408 DIESEL	1995-1997	INTERNATIONAL/NAVISTAR	4900	INTERNATIONAL/NAVISTAR DT466	1995-2002
INTERNATIONAL/NAVISTAR	4800	INTERNATIONAL/NAVISTAR DT408 DIESEL	1995-1997	INTERNATIONAL/NAVISTAR	7100	INTERNATIONAL/NAVISTAR DT466	1995-1995
INTERNATIONAL/NAVISTAR	4900	INTERNATIONAL/NAVISTAR DT408 DIESEL	1995-1997	INTERNATIONAL/NAVISTAR	7300	INTERNATIONAL/NAVISTAR DT466	2002-2003
INTERNATIONAL/NAVISTAR	9000	CUMMINS ISM DIESEL	2004-2004	INTERNATIONAL/NAVISTAR	7400	INTERNATIONAL/NAVISTAR DT466	2002-2003
INTERNATIONAL/NAVISTAR	9200	CUMMINS ISM DIESEL	2005-2005	INTERNATIONAL/NAVISTAR	7500	INTERNATIONAL/NAVISTAR DT466	2002-2002
INTERNATIONAL/NAVISTAR	9200I	CUMMINS ISM DIESEL	2003-2007	INTERNATIONAL/NAVISTAR	7500	INTERNATIONAL/NAVISTAR DT530 DIESEL	2004-2005
INTERNATIONAL/NAVISTAR	9400I	CUMMINS ISM DIESEL	2004-2007	INTERNATIONAL/NAVISTAR	8100	CATERPILLAR 3176 DIESEL	1995-1997
K080745				INTERNATIONAL/NAVISTAR	8100	CATERPILLAR 3176 DIESEL	1995-1997
FREIGHTLINER	COLUMBIA	CUMMINS ISM DIESEL	2001-2001	INTERNATIONAL/NAVISTAR	8100	INTERNATIONAL/NAVISTAR DT466	1996-2000
INTERNATIONAL/NAVISTAR	4700	INTERNATIONAL/NAVISTAR DT408 DIESEL	1995-1997	INTERNATIONAL/NAVISTAR	FE	INTERNATIONAL/NAVISTAR DT466	2005-2005
INTERNATIONAL/NAVISTAR	4800	INTERNATIONAL/NAVISTAR DT408 DIESEL	1995-1997	INTERNATIONAL/NAVISTAR	FE	INTERNATIONAL/NAVISTAR DT466	2009-2009
INTERNATIONAL/NAVISTAR	4900	INTERNATIONAL/NAVISTAR DT408 DIESEL	1995-1997	KENWORTH	T300	CATERPILLAR 3126 DIESEL	1996-1997
INTERNATIONAL/NAVISTAR	8100	INTERNATIONAL/NAVISTAR 530 DIESEL	1995-1995	KENWORTH	T300	CATERPILLAR 3126 DIESEL	1998-2003
INTERNATIONAL/NAVISTAR	8100	INTERNATIONAL/NAVISTAR DT466	1996-1997	K080776			
INTERNATIONAL/NAVISTAR	8100	INTERNATIONAL/NAVISTAR DT466	1995-1995	STERLING	L-LINE	CATERPILLAR 3126 DIESEL	2002-2004
KENWORTH	T300	CUMMINS ISC DIESEL	1998-2004	STERLING	L-LINE	CATERPILLAR C7 DIESEL	2004-2004
VOLVO	9700 FL	B12	2005-2011	K080780			
K080751				FREIGHTLINER	BUSINESS CLASS M2	CATERPILLAR 3126 DIESEL	2002-2007
FREIGHTLINER	FLC	CATERPILLAR 3176 DIESEL	1991-1996	FREIGHTLINER	BUSINESS CLASS M2	CATERPILLAR C7 DIESEL	2004-2007
FREIGHTLINER	FLD	CATERPILLAR 3176 DIESEL	1991-1996	FREIGHTLINER	CENTURY CLASS	CATERPILLAR C10 DIESEL	2002-2002
K080755				FREIGHTLINER	CENTURY CLASS	CATERPILLAR C12 DIESEL	2002-2002
INTERNATIONAL/NAVISTAR	5500I	INTERNATIONAL/NAVISTAR DT466	2001-2002	FREIGHTLINER	FLD	CATERPILLAR C10 DIESEL	2001-2002
INTERNATIONAL/NAVISTAR	5600I	INTERNATIONAL/NAVISTAR DT466	2001-2002	FREIGHTLINER	FLD	CATERPILLAR C12 DIESEL	2001-2002
K080760				INTERNATIONAL/NAVISTAR	5000	CATERPILLAR C10 DIESEL	1998-2000
FREIGHTLINER	FLD120	CUMMINS ISM DIESEL	2001-2002	INTERNATIONAL/NAVISTAR	5000	CATERPILLAR C12 DIESEL	1998-2000
INTERNATIONAL/NAVISTAR	7400	INTERNATIONAL/NAVISTAR 530 DIESEL	2002-2003	INTERNATIONAL/NAVISTAR	5500I	CATERPILLAR C10 DIESEL	2000-2002
INTERNATIONAL/NAVISTAR	7400	INTERNATIONAL/NAVISTAR DT530 DIESEL	2004-2005	INTERNATIONAL/NAVISTAR	5500I	CATERPILLAR C12 DIESEL	2000-2002
INTERNATIONAL/NAVISTAR	7500	INTERNATIONAL/NAVISTAR 530 DIESEL	2002-2003	INTERNATIONAL/NAVISTAR	5600I	CATERPILLAR C10 DIESEL	2000-2002
INTERNATIONAL/NAVISTAR	8100	CATERPILLAR 3406 DIESEL	1998-1998	INTERNATIONAL/NAVISTAR	5600I	CATERPILLAR C12 DIESEL	2000-2002
INTERNATIONAL/NAVISTAR	8100	CATERPILLAR C10 DIESEL	1998-2001	INTERNATIONAL/NAVISTAR	5900I	CATERPILLAR C10 DIESEL	2000-2002
INTERNATIONAL/NAVISTAR	8100	INTERNATIONAL/NAVISTAR 530 DIESEL	1996-2003	INTERNATIONAL/NAVISTAR	5900I	CATERPILLAR C12 DIESEL	2000-2002
INTERNATIONAL/NAVISTAR	8200	INTERNATIONAL/NAVISTAR 530 DIESEL	1996-1997	INTERNATIONAL/NAVISTAR	PAYSTAR	CATERPILLAR C10 DIESEL	2000-2000
INTERNATIONAL/NAVISTAR	8200	INTERNATIONAL/NAVISTAR DT466	1997-1997	INTERNATIONAL/NAVISTAR	PAYSTAR	CATERPILLAR C12 DIESEL	2000-2000
INTERNATIONAL/NAVISTAR	RE	INTERNATIONAL/NAVISTAR 530 DIESEL	1998-2001	STERLING	ACTERRA	CATERPILLAR 3126 DIESEL	2001-2004
K080765				STERLING	L-LINE	CATERPILLAR 3126 DIESEL	2000-2001
INTERNATIONAL/NAVISTAR	RE	INTERNATIONAL/NAVISTAR 530 DIESEL	2003-2004	K080785			
K080774				FREIGHTLINER	BUSINESS CLASS M2	CATERPILLAR C9 DIESEL	2004-2007
DINA	MARCOPOLO GV850	CATERPILLAR C10 DIESEL	1992-1998	FREIGHTLINER	FL112	CUMMINS ISM DIESEL	2000-2000
FORD	F-650 SUPER DUTY	CATERPILLAR C7 DIESEL	2004-2006	FREIGHTLINER	FLD	CUMMINS ISM DIESEL	2000-2000
FORD	F-750 SUPER DUTY	CATERPILLAR C7 DIESEL	2004-2006	FREIGHTLINER	FLD	CUMMINS M11 DIESEL	2000-2000
FREIGHTLINER	BUSINESS CLASS M2	CATERPILLAR 3126 DIESEL	2003-2007	K080790			
FREIGHTLINER	BUSINESS CLASS M2	CATERPILLAR 3126 DIESEL	2002-2002	VOLVO	C11R URBANO	CUMMINS ISB DIESEL	2004-2004
FREIGHTLINER	BUSINESS CLASS M2	CATERPILLAR C7 DIESEL	2004-2007	K080794			
INTERNATIONAL/NAVISTAR	4700	INTERNATIONAL/NAVISTAR DT466	1995-2002	INTERNATIONAL/NAVISTAR	PROSTAR SERIES	INTERNATIONAL/NAVISTAR MAXXFORCE 13 DIESEL	2008-2010
INTERNATIONAL/NAVISTAR	4800	INTERNATIONAL/NAVISTAR DT466	1995-2003	K080797			



MASTER SERVICIO PESADO 2014

BANDAS

MARCA	MODELO	MOTOR	AÑOS	MARCA	MODELO	MOTOR	AÑOS
FORD	F-650 SUPER DUTY	CUMMINS ISB DIESEL	2005-2007	FREIGHTLINER	CLASSIC XL	CUMMINS ISM DIESEL	2001-2001
FORD	F-750 SUPER DUTY	CUMMINS ISB DIESEL	2005-2007	FREIGHTLINER	FLD	CUMMINS ISM DIESEL	2001-2001
KENWORTH	T800	CUMMINS ISC 260	2001-2001	INTERNATIONAL/NAVISTAR	MXT	INTERNATIONAL/NAVISTAR VT365 DIESEL	2007-2008
KENWORTH	T800	CATERPILLAR C10 DIESEL	2003-2003	INTERNATIONAL/NAVISTAR	WORKSTAR 7600	CUMMINS ISM DIESEL	2009-2010
KENWORTH	T800	CATERPILLAR C12 DIESEL	1998-1998	STERLING	ACTERRA	CUMMINS ISB-07 DIESEL	2008-2008
KENWORTH	T800	CATERPILLAR C12 DIESEL	2003-2003	STERLING	L-LINE	CATERPILLAR C7 DIESEL	2007-2007
K080806				K080817			
CHEVROLET	C6500	CATERPILLAR C7 DIESEL	2004-2007	FREIGHTLINER	CLASSIC	CUMMINS ISM DIESEL	2001-2003
CHEVROLET	C7500	CATERPILLAR C7 DIESEL	2004-2007	FREIGHTLINER	CLASSIC XL	CUMMINS ISM DIESEL	2002-2003
CHEVROLET	C8500	CATERPILLAR C7 DIESEL	2004-2007	FREIGHTLINER	FLD	CUMMINS ISM DIESEL	2002-2003
FORD	E450 SUPER DUTY	FORD V10, 6.8 L	1999-2001	K080820			
FORD	E450 SUPER DUTY	FORD V8, 5.4 L	2000-2001	FORD	F-650 SUPER DUTY	FORD V8, 7.3 L DIESEL	2000-2004
FORD	F-450 SUPER DUTY	FORD V10, 6.8 L	1999-2001	FORD	F-750 SUPER DUTY	FORD V8, 7.3 L DIESEL	2000-2004
FORD	F-450 SUPER DUTY	V10, 6.8 L	1999-2004	FREIGHTLINER	BUSINESS CLASS M2	CUMMINS ISC DIESEL	2007-2011
FORD	F-450 SUPER DUTY	V8, 5.4 L	1999-2000	FREIGHTLINER	BUSINESS CLASS M2	CUMMINS ISC DIESEL	2006-2006
FORD	F-550 SUPER DUTY	FORD V10, 6.8 L	1999-2001	STERLING	ACTERRA	CUMMINS ISC DIESEL	2005-2008
INTERNATIONAL/NAVISTAR	5500	CUMMINS ISM DIESEL	2005-2005	K080825			
INTERNATIONAL/NAVISTAR	5500I	CUMMINS ISM DIESEL	2002-2006	DINA	D-7400 HTQ	CATERPILLAR 3126 E DIESEL	1996-2000
INTERNATIONAL/NAVISTAR	5600	CUMMINS ISX DIESEL	2005-2005	FREIGHTLINER	BUSINESS CLASS M2	MERCEDES-BENZ MBE 900 DIESEL	2008-2008
INTERNATIONAL/NAVISTAR	5600I	CUMMINS ISM DIESEL	2002-2007	FREIGHTLINER	BUSINESS CLASS M2	MERCEDES-BENZ MBE 900 DIESEL	2006-2007
INTERNATIONAL/NAVISTAR	5900I	CUMMINS ISM DIESEL	2001-2006	FREIGHTLINER	BUSINESS CLASS M2	MERCEDES-BENZ MBE 900 DIESEL	2006-2007
INTERNATIONAL/NAVISTAR	7400	CUMMINS ISM DIESEL	2005-2005	INTERNATIONAL/NAVISTAR	4300	INTERNATIONAL/NAVISTAR DT466	2005-2008
INTERNATIONAL/NAVISTAR	7600	CUMMINS ISM DIESEL	2003-2007	INTERNATIONAL/NAVISTAR	4400	INTERNATIONAL/NAVISTAR DT466	2006-2008
INTERNATIONAL/NAVISTAR	7700	CUMMINS ISM DIESEL	2005-2006	KENWORTH	K100	CUMMINS C Series 8.3 L DIESEL	1992-1993
INTERNATIONAL/NAVISTAR	WORKSTAR 7600	CUMMINS ISM DIESEL	2008-2008	KENWORTH	T370	PACCAR PX-6	2012-2013
KENWORTH	T800	CATERPILLAR C10 DIESEL	2000-2002	KENWORTH	T600	CATERPILLAR C10 DIESEL	1997-2004
KENWORTH	T800	CATERPILLAR C12 DIESEL	2000-2002	KENWORTH	T600	CATERPILLAR C12 DIESEL	1996-2004
KENWORTH	T800	CUMMINS ISL	2006-2006	KENWORTH	T800	CATERPILLAR C10 DIESEL	1997-1999
KENWORTH	T800	CUMMINS ISL DIESEL	2006-2009	KENWORTH	T800	CATERPILLAR C10 DIESEL	2000-2002
K080810				KENWORTH	T800	CATERPILLAR C12 DIESEL	1996-1999
DODGE	RAM-4000	V6, 5.9 L DIESEL	2002-2002	KENWORTH	T800	CATERPILLAR C12 DIESEL	2000-2002
KENWORTH	T300	CATERPILLAR C7 DIESEL	2004-2007	STERLING	ACTERRA	MERCEDES-BENZ MBE 900 DIESEL	2006-2007
KENWORTH	T800	CATERPILLAR C10 DIESEL	2004-2004	STERLING	A-LINE	CATERPILLAR C9 DIESEL	2004-2004
KENWORTH	T800	CATERPILLAR C10 DIESEL	2003-2003	STERLING	L-LINE	CATERPILLAR C9 DIESEL	2004-2004
KENWORTH	T800	CATERPILLAR C12 DIESEL	2004-2004	K080830			
KENWORTH	T800	CATERPILLAR C12 DIESEL	2003-2003	FORD	F-600	CUMMINS B Series 5.9 L DIESEL	1992-1994
KENWORTH	W900	CATERPILLAR C10 DIESEL	2001-2004	FORD	F-650 SUPER DUTY	FORD V8, 6.0 L DIESEL	2003-2006
KENWORTH	W900	CATERPILLAR C12 DIESEL	2001-2001	FORD	F-750 SUPER DUTY	FORD V8, 6.0 L DIESEL	2003-2006
STERLING	ACTERRA	MERCEDES-BENZ MBE 900 DIESEL	2004-2004	FORD	F-800	CUMMINS ISB DIESEL	1999-1999
K080816				FORD	F-800	CUMMINS ISB DIESEL	1998-1998
FORD	F-650 SUPER DUTY	CATERPILLAR 3126 DIESEL	2000-2004	FREIGHTLINER	BUSINESS CLASS M2	MERCEDES-BENZ MBE 900 DIESEL	2002-2005
FORD	F-750 SUPER DUTY	CATERPILLAR 3126 DIESEL	2000-2004	INTERNATIONAL/NAVISTAR	4100	INTERNATIONAL/NAVISTAR VT365 DIESEL	2006-2007
FREIGHTLINER	BUSINESS CLASS M2	CUMMINS ISB DIESEL	2007-2007	INTERNATIONAL/NAVISTAR	4200	INTERNATIONAL/NAVISTAR VT365 DIESEL	2002-2007
FREIGHTLINER	BUSINESS CLASS M2	CUMMINS ISB-07 DIESEL	2008-2008	INTERNATIONAL/NAVISTAR	4300	INTERNATIONAL/NAVISTAR VT365 DIESEL	2003-2003
FREIGHTLINER	CLASSIC	CUMMINS ISM DIESEL	2001-2001	INTERNATIONAL/NAVISTAR	4400	INTERNATIONAL/NAVISTAR VT365 DIESEL	2003-2003



MASTER SERVICIO PESADO 2014

BANDAS

MARCA	MODELO	MOTOR	AÑOS	MARCA	MODELO	MOTOR	AÑOS
INTERNATIONAL/NAVISTAR	RE	INTERNATIONAL/NAVISTAR DT466	2006-2008			K080859	
STERLING	ACTERRA	MERCEDES-BENZ MBE 900 DIESEL	2001-2005	INTERNATIONAL/NAVISTAR	8100	CATERPILLAR C10 DIESEL	2002-2003
		K080834		INTERNATIONAL/NAVISTAR	8600	CATERPILLAR C10 DIESEL	2003-2004
FORD	F-650 SUPER DUTY	CUMMINS ISB-07 DIESEL	2008-2009	INTERNATIONAL/NAVISTAR	8600	CATERPILLAR C12 DIESEL	2003-2004
FORD	F-750 SUPER DUTY	CUMMINS ISB-07 DIESEL	2008-2009	KENWORTH	T300	CATERPILLAR C7 DIESEL	2005-2005
		K080839				K080865	
DINA	D-7400 HTQ	CATERPILLAR 3126 DIESEL	1996-2000	FORD	F-450 SUPER DUTY	V8, 6.4 L DIESEL	2008-2008
FORD	F-600	CUMMINS B Series 5.9 L DIESEL	1993-1994	FORD	F-450 SUPER DUTY	V8, 6.4 L DIESEL	2009-2010
		K080842		FORD	F-450 SUPER DUTY	V8, 6.4 L DIESEL	2009-2010
INTERNATIONAL/NAVISTAR	RE	INTERNATIONAL/NAVISTAR DT466	1998-2005	FORD	F-550 SUPER DUTY	V8, 6.4 L DIESEL	2009-2009
KENWORTH	T600	CATERPILLAR C15 DIESEL	2000-2005	FORD	F-550 SUPER DUTY	V8, 6.4 L DIESEL	2008-2010
KENWORTH	T800	CATERPILLAR C15 DIESEL	2004-2004			K080868	
		K080845		KENWORTH	T300	PACCAR PX-6 DIESEL	2007-2010
INTERNATIONAL/NAVISTAR	4400	INTERNATIONAL/NAVISTAR DT570 DIESEL	2004-2008	KENWORTH	T300	PACCAR PX-6 DIESEL	2008-2010
		K080855		KENWORTH	T370	PACCAR PX-6	2009-2011
FREIGHTLINER	ARGOSY	CATERPILLAR C10 DIESEL	2000-2003			K080872	
FREIGHTLINER	ARGOSY	CATERPILLAR C12 DIESEL	2000-2004	FREIGHTLINER	FL112	CATERPILLAR C10 DIESEL	2003-2004
FREIGHTLINER	BUSINESS CLASS M2	MERCEDES-BENZ MBE 4000 DIESEL	2004-2007	FREIGHTLINER	FL112	CATERPILLAR C12 DIESEL	2003-2003
FREIGHTLINER	CASCADIA	MERCEDES BENZ MBE 4000 Diesel	2008-2012			K080876	
FREIGHTLINER	CENTURY CLASS	CATERPILLAR C10 DIESEL	2001-2001	STERLING	L-LINE	CATERPILLAR C7 DIESEL	2005-2005
FREIGHTLINER	CENTURY CLASS	CATERPILLAR C10 DIESEL	2000-2000			K080878	
FREIGHTLINER	CENTURY CLASS	CATERPILLAR C12 DIESEL	2001-2001	FREIGHTLINER	FLD120	CATERPILLAR C10 DIESEL	2001-2004
FREIGHTLINER	CENTURY CLASS	CATERPILLAR C12 DIESEL	2000-2000	FREIGHTLINER	FLD120	CATERPILLAR C12 DIESEL	2001-2004
FREIGHTLINER	CENTURY CLASS	MERCEDES BENZ MBE 4000 Diesel	2009-2010	KENWORTH	T300	CUMMINS ISC DIESEL	2006-2006
FREIGHTLINER	CENTURY CLASS	MERCEDES-BENZ MBE 4000 DIESEL	2005-2005	KENWORTH	T300	CUMMINS ISC DIESEL	2007-2008
FREIGHTLINER	CLASSIC	MERCEDES BENZ MBE 4000 Diesel	2009-2010			K080893	
FREIGHTLINER	CLASSIC XL	MERCEDES BENZ MBE 4000 Diesel	2009-2010	FORD	F-650 SUPER DUTY	FORD V8, 7.3 L DIESEL	2000-2004
FREIGHTLINER	COLUMBIA	MERCEDES BENZ MBE 4000 Diesel	2008-2010	FORD	F-750 SUPER DUTY	FORD V8, 7.3 L DIESEL	2000-2004
FREIGHTLINER	COLUMBIA	MERCEDES-BENZ MBE 4000 DIESEL	2005-2007	INTERNATIONAL/NAVISTAR	3800	INTERNATIONAL/NAVISTAR T444 DIESEL	1998-2002
FREIGHTLINER	FL112	CATERPILLAR C10 DIESEL	1999-1999	INTERNATIONAL/NAVISTAR	4600	INTERNATIONAL/NAVISTAR T444 DIESEL	1995-1995
FREIGHTLINER	FL112	CATERPILLAR C10 DIESEL	2000-2002	INTERNATIONAL/NAVISTAR	4700	INTERNATIONAL/NAVISTAR T444 DIESEL	1995-2002
FREIGHTLINER	FL112	CATERPILLAR C12 DIESEL	1999-1999	INTERNATIONAL/NAVISTAR	4800	INTERNATIONAL/NAVISTAR T444 DIESEL	1995-1997
FREIGHTLINER	FL112	CATERPILLAR C12 DIESEL	2000-2002	INTERNATIONAL/NAVISTAR	4900	INTERNATIONAL/NAVISTAR T444 DIESEL	1995-1997
FREIGHTLINER	FLD	CATERPILLAR C10 DIESEL	2001-2001	INTERNATIONAL/NAVISTAR	CONVENTIONAL IC	INTERNATIONAL/NAVISTAR T444 DIESEL	2002-2002
FREIGHTLINER	FLD	CATERPILLAR C10 DIESEL	2000-2000	KENWORTH	T600	CATERPILLAR C15 DIESEL	2000-2005
FREIGHTLINER	FLD	CATERPILLAR C12 DIESEL	2001-2001	KENWORTH	T800	CATERPILLAR C15 DIESEL	2004-2004
FREIGHTLINER	FLD	CATERPILLAR C12 DIESEL	2000-2000			K080897	
FREIGHTLINER	FLD	MERCEDES BENZ MBE 4000 Diesel	2009-2010	STERLING	A-LINE	CATERPILLAR C10 DIESEL	2002-2004
INTERNATIONAL/NAVISTAR	CE	INTERNATIONAL/NAVISTAR VT365 DIESEL	2005-2005	STERLING	A-LINE	CATERPILLAR C12 DIESEL	2002-2004
INTERNATIONAL/NAVISTAR	WORKSTAR 7400	INTERNATIONAL/NAVISTAR MAXXFORCE 9 DIESEL	2010-2012			K080915	
KENWORTH	T300	PACCAR PX-6 DIESEL	2008-2010	INTERNATIONAL/NAVISTAR	9200I	CATERPILLAR C10 DIESEL	2004-2004
KENWORTH	T370	PACCAR PX-6	2009-2011	INTERNATIONAL/NAVISTAR	9200I	CATERPILLAR C12 DIESEL	2004-2004
STERLING	A-LINE	MERCEDES-BENZ MBE 4000 DIESEL	2008-2008			K080922	
STERLING	A-LINE	MERCEDES-BENZ MBE 4000 DIESEL	2004-2006	FREIGHTLINER	CENTURY CLASS	CATERPILLAR C10 DIESEL	1998-2003
STERLING	L-LINE	MERCEDES-BENZ MBE 4000 DIESEL	2003-2007	FREIGHTLINER	CENTURY CLASS	CATERPILLAR C12 DIESEL	1998-2004



MASTER SERVICIO PESADO 2014

BANDAS

MARCA	MODELO	MOTOR	AÑOS
FREIGHTLINER	FLD	CATERPILLAR C10 DIESEL	1998-2003
FREIGHTLINER	FLD	CATERPILLAR C12 DIESEL	1998-2003
INTERNATIONAL/NAVISTAR	4600	INTERNATIONAL/NAVISTAR T444 DIESEL	1995-1995
INTERNATIONAL/NAVISTAR	4700	INTERNATIONAL/NAVISTAR T444 DIESEL	1995-2002
INTERNATIONAL/NAVISTAR	4800	INTERNATIONAL/NAVISTAR T444 DIESEL	1995-1997
INTERNATIONAL/NAVISTAR	4900	INTERNATIONAL/NAVISTAR T444 DIESEL	1995-1997
INTERNATIONAL/NAVISTAR	7500	INTERNATIONAL/NAVISTAR DT570 DIESEL	2005-2005
INTERNATIONAL/NAVISTAR	8500	INTERNATIONAL/NAVISTAR DT570 DIESEL	2005-2005
INTERNATIONAL/NAVISTAR	CE	INTERNATIONAL/NAVISTAR DT466	2005-2005
K080926			
FREIGHTLINER	CENTURY CLASS	CATERPILLAR C15 DIESEL	2005-2006
FREIGHTLINER	CLASSIC XL	CATERPILLAR C15 DIESEL	2005-2005
FREIGHTLINER	COLUMBIA	CATERPILLAR C15 DIESEL	2005-2005
FREIGHTLINER	COLUMBIA	CATERPILLAR C15 DIESEL	2006-2007
FREIGHTLINER	CORONADO	CATERPILLAR C15 DIESEL	2005-2006
FREIGHTLINER	FLD	CATERPILLAR C15 DIESEL	2005-2006
INTERNATIONAL/NAVISTAR	7300	INTERNATIONAL/NAVISTAR DT466	2006-2006
INTERNATIONAL/NAVISTAR	7400	INTERNATIONAL/NAVISTAR DT466	2005-2007
INTERNATIONAL/NAVISTAR	CXT	INTERNATIONAL/NAVISTAR DT466	2005-2006
STERLING	ACTERRA	CATERPILLAR C13 DIESEL	2006-2006
K080934			
INTERNATIONAL/NAVISTAR	7300	INTERNATIONAL/NAVISTAR DT466	2005-2005
INTERNATIONAL/NAVISTAR	7400	INTERNATIONAL/NAVISTAR DT466	2005-2005
KENWORTH	T600	CATERPILLAR C15 DIESEL	2006-2008
KENWORTH	T800	CATERPILLAR C15 DIESEL	2005-2005
KENWORTH	T800	CATERPILLAR C15 DIESEL	2006-2009
K080939			
FREIGHTLINER	COLUMBIA	CATERPILLAR C15 DIESEL	2002-2003
FREIGHTLINER	COLUMBIA	CATERPILLAR C16 DIESEL	2002-2004
FREIGHTLINER	CORONADO	CATERPILLAR C15 DIESEL	2002-2004
FREIGHTLINER	CORONADO	CATERPILLAR C16 DIESEL	2002-2003
KENWORTH	T2000	CATERPILLAR C15 DIESEL	2004-2010
K080944			
FREIGHTLINER	CLASSIC	CATERPILLAR C15 DIESEL	2003-2003
FREIGHTLINER	CLASSIC	CATERPILLAR C16 DIESEL	2003-2003
FREIGHTLINER	CLASSIC XL	CATERPILLAR C15 DIESEL	2003-2004
FREIGHTLINER	CLASSIC XL	CATERPILLAR C16 DIESEL	2003-2003
FREIGHTLINER	COLUMBIA	CATERPILLAR C15 DIESEL	2003-2003
FREIGHTLINER	COLUMBIA	CATERPILLAR C16 DIESEL	2003-2004
FREIGHTLINER	FLD	CATERPILLAR C15 DIESEL	2003-2004
FREIGHTLINER	FLD	CATERPILLAR C16 DIESEL	2003-2004
INTERNATIONAL/NAVISTAR	7500	INTERNATIONAL/NAVISTAR HT570 DIESEL	2005-2007
INTERNATIONAL/NAVISTAR	8600	CATERPILLAR C11 DIESEL	2004-2007
INTERNATIONAL/NAVISTAR	8600	CATERPILLAR C13 DIESEL	2004-2007
K080952			

MARCA	MODELO	MOTOR	AÑOS
FREIGHTLINER	ARGOSY	CATERPILLAR 3406 DIESEL	1999-2000
FREIGHTLINER	ARGOSY	CATERPILLAR C15 DIESEL	2001-2004
FREIGHTLINER	BUSINESS CLASS M2	CATERPILLAR C13 DIESEL	2006-2007
FREIGHTLINER	CENTURY CLASS	CATERPILLAR 3406 DIESEL	1998-1999
FREIGHTLINER	CENTURY CLASS	CATERPILLAR C15 DIESEL	2001-2004
FREIGHTLINER	CLASSIC	CATERPILLAR C15 DIESEL	2001-2002
FREIGHTLINER	CLASSIC	CATERPILLAR C16 DIESEL	2001-2002
FREIGHTLINER	CLASSIC XL	CATERPILLAR C15 DIESEL	2001-2002
FREIGHTLINER	CLASSIC XL	CATERPILLAR C16 DIESEL	2001-2002
FREIGHTLINER	COLUMBIA	CATERPILLAR C11 DIESEL	2004-2004
FREIGHTLINER	COLUMBIA	CATERPILLAR C13 DIESEL	2005-2005
FREIGHTLINER	COLUMBIA	CATERPILLAR C13 DIESEL	2004-2009
FREIGHTLINER	COLUMBIA	CATERPILLAR C15 DIESEL	2001-2001
FREIGHTLINER	COLUMBIA	CATERPILLAR C15 DIESEL	2002-2002
FREIGHTLINER	COLUMBIA	CATERPILLAR C16 DIESEL	2001-2001
FREIGHTLINER	COLUMBIA	CATERPILLAR C16 DIESEL	2002-2002
FREIGHTLINER	CORONADO	CATERPILLAR C15 DIESEL	2002-2004
FREIGHTLINER	CORONADO	CATERPILLAR C16 DIESEL	2002-2003
FREIGHTLINER	FLD	CATERPILLAR 3406 DIESEL	1998-2000
FREIGHTLINER	FLD	CATERPILLAR C15 DIESEL	2000-2002
FREIGHTLINER	FLD	CATERPILLAR C16 DIESEL	2000-2002
INTERNATIONAL/NAVISTAR	7400	INTERNATIONAL/NAVISTAR 570 DIESEL	2006-2006
INTERNATIONAL/NAVISTAR	7400	INTERNATIONAL/NAVISTAR DT570 DIESEL	2006-2006
INTERNATIONAL/NAVISTAR	7400	INTERNATIONAL/NAVISTAR DT570 DIESEL	2005-2007
INTERNATIONAL/NAVISTAR	7500	INTERNATIONAL/NAVISTAR HT570	2006-2006
KENWORTH	T800	CATERPILLAR C11 DIESEL	2003-2009
KENWORTH	T800	CATERPILLAR C13 DIESEL	2004-2007
KENWORTH	W900	CATERPILLAR C15 DIESEL	2005-2007
KENWORTH	W900	CATERPILLAR C15 DIESEL	2004-2004
K080956			
FORD	F-450 SUPER DUTY	V8, 6.4 L DIESEL	2008-2008
FORD	F-450 SUPER DUTY	V8, 6.4 L DIESEL	2009-2010
FORD	F-450 SUPER DUTY	V8, 6.4 L DIESEL	2009-2010
FORD	F-550 SUPER DUTY	V8, 6.4 L DIESEL	2008-2010
KENWORTH	T300	CUMMINS ISC DIESEL	2007-2008
K080962			
INTERNATIONAL/NAVISTAR	BE	INTERNATIONAL/NAVISTAR MAXXFORCE 7 DIESEL	2009-2010
K080968			
KENWORTH	W900	CATERPILLAR C13 DIESEL	2004-2007
K080970			
SCANIA	IRIZAR I5	K420	2012-2013
SCANIA	IRIZAR I6	K420	2013-2013
K080986			
INTERNATIONAL/NAVISTAR	7600	CATERPILLAR 3406 DIESEL	2003-2003
INTERNATIONAL/NAVISTAR	7600	CATERPILLAR C10 DIESEL	2002-2003



MASTER SERVICIO PESADO 2014

BANDAS

MARCA	MODELO	MOTOR	AÑOS	MARCA	MODELO	MOTOR	AÑOS
INTERNATIONAL/NAVISTAR	7600	CATERPILLAR C12 DIESEL	2002-2003	FREIGHTLINER	FLD120	CATERPILLAR C11 DIESEL	2005-2005
K080991				FREIGHTLINER	FLD120	CATERPILLAR C13 DIESEL	2005-2005
FORD	E450 SUPER DUTY	FORD V10, 6.8 L	1999-2001	KENWORTH	K300	CUMMINS C Series 8.3 L DIESEL	1995-1995
FORD	E450 SUPER DUTY	FORD V8, 5.4 L	2000-2001	KENWORTH	T300	CUMMINS C Series 8.3 L DIESEL	1996-1997
FREIGHTLINER	CLASSIC	CATERPILLAR C15 DIESEL	2004-2006	K081023			
FREIGHTLINER	CLASSIC XL	CATERPILLAR C15 DIESEL	2006-2006	KENWORTH	T800	CATERPILLAR C15 DIESEL	2006-2006
FREIGHTLINER	FLD	CATERPILLAR C15 DIESEL	2007-2008	KENWORTH	T800	CATERPILLAR C15 DIESEL	2007-2009
INTERNATIONAL/NAVISTAR	9400	CATERPILLAR C15 DIESEL	2005-2005	K081035			
INTERNATIONAL/NAVISTAR	9400I	CATERPILLAR C15 DIESEL	2004-2007	INTERNATIONAL/NAVISTAR	4600	INTERNATIONAL/NAVISTAR T444 DIESEL	1995-1995
INTERNATIONAL/NAVISTAR	BE	INTERNATIONAL/NAVISTAR MAXXFORCE 7 DIESEL	2011-2011	INTERNATIONAL/NAVISTAR	4700	INTERNATIONAL/NAVISTAR T444 DIESEL	1995-2002
K081000				INTERNATIONAL/NAVISTAR	4800	INTERNATIONAL/NAVISTAR T444 DIESEL	1995-1997
FORD	F-450 SUPER DUTY	FORD V10, 6.8 L	1999-2001	INTERNATIONAL/NAVISTAR	4900	INTERNATIONAL/NAVISTAR T444 DIESEL	1995-1997
FORD	F-450 SUPER DUTY	V10, 6.8 L	1999-2004	K081047			
FORD	F-450 SUPER DUTY	V8, 5.4 L	1999-2000	INTERNATIONAL/NAVISTAR	BE	INTERNATIONAL/NAVISTAR MAXXFORCE 7 DIESEL	2012-2013
FORD	F-550 SUPER DUTY	FORD V10, 6.8 L	1999-2001	INTERNATIONAL/NAVISTAR	DURASTAR 4300	INTERNATIONAL/NAVISTAR MAXXFORCE 7 DIESEL	2011-2012
INTERNATIONAL/NAVISTAR	4600	INTERNATIONAL/NAVISTAR T444 DIESEL	1995-1995	INTERNATIONAL/NAVISTAR	DURASTAR 4300	INTERNATIONAL/NAVISTAR MAXXFORCE DT DIESEL	2010-2010
INTERNATIONAL/NAVISTAR	4700	INTERNATIONAL/NAVISTAR T444 DIESEL	1995-2002	K081065			
INTERNATIONAL/NAVISTAR	4800	INTERNATIONAL/NAVISTAR T444 DIESEL	1995-1997	INTERNATIONAL/NAVISTAR	DURASTAR 4300	INTERNATIONAL/NAVISTAR MAXXFORCE 7 DIESEL	2009-2010
INTERNATIONAL/NAVISTAR	4900	INTERNATIONAL/NAVISTAR T444 DIESEL	1995-1997	K081079			
INTERNATIONAL/NAVISTAR	9200I	CATERPILLAR C13 DIESEL	2004-2008	STERLING	A-LINE	CATERPILLAR C11 DIESEL	2004-2004
INTERNATIONAL/NAVISTAR	9400I	CATERPILLAR C13 DIESEL	2004-2007	STERLING	L-LINE	CATERPILLAR C11 DIESEL	2004-2007
K081005				STERLING	L-LINE	CATERPILLAR C13 DIESEL	2006-2007
FREIGHTLINER	BUSINESS CLASS M2	CATERPILLAR C13 DIESEL	2004-2005	STERLING	L-LINE	CATERPILLAR C15 DIESEL	2006-2007
FREIGHTLINER	CENTURY CLASS	CATERPILLAR C11 DIESEL	2006-2006	STERLING	L-LINE	CATERPILLAR C9 DIESEL	2007-2007
FREIGHTLINER	CENTURY CLASS	CATERPILLAR C13 DIESEL	2006-2006	K081088			
FREIGHTLINER	COLUMBIA	CATERPILLAR C11 DIESEL	2006-2007	INTERNATIONAL/NAVISTAR	5900I	CATERPILLAR C15 DIESEL	2004-2006
FREIGHTLINER	COLUMBIA	CATERPILLAR C13 DIESEL	2006-2006	INTERNATIONAL/NAVISTAR	PAYSTAR 5600I	CATERPILLAR C15 DIESEL	2008-2008
FREIGHTLINER	FLD	CATERPILLAR C11 DIESEL	2005-2007	K081092			
FREIGHTLINER	FLD	CATERPILLAR C13 DIESEL	2005-2007	INTERNATIONAL/NAVISTAR	5500I	CATERPILLAR C13 DIESEL	2005-2007
INTERNATIONAL/NAVISTAR	5500I	CATERPILLAR C10 DIESEL	2003-2004	INTERNATIONAL/NAVISTAR	5600I	CATERPILLAR C13 DIESEL	2005-2005
INTERNATIONAL/NAVISTAR	5500I	CATERPILLAR C12 DIESEL	2003-2004	INTERNATIONAL/NAVISTAR	7600	CATERPILLAR C11 DIESEL	2004-2007
INTERNATIONAL/NAVISTAR	5600I	CATERPILLAR C10 DIESEL	2003-2004	INTERNATIONAL/NAVISTAR	7600	CATERPILLAR C13 DIESEL	2004-2008
INTERNATIONAL/NAVISTAR	5600I	CATERPILLAR C12 DIESEL	2003-2004	INTERNATIONAL/NAVISTAR	7700	CATERPILLAR C11 DIESEL	2005-2006
INTERNATIONAL/NAVISTAR	5900I	CATERPILLAR C10 DIESEL	2003-2003	INTERNATIONAL/NAVISTAR	7700	CATERPILLAR C13 DIESEL	2005-2006
INTERNATIONAL/NAVISTAR	5900I	CATERPILLAR C12 DIESEL	2003-2004	INTERNATIONAL/NAVISTAR	9900	CATERPILLAR C15 DIESEL	2005-2005
INTERNATIONAL/NAVISTAR	7600	CATERPILLAR C10 DIESEL	2004-2004	INTERNATIONAL/NAVISTAR	9900I	CATERPILLAR C15 DIESEL	2004-2008
INTERNATIONAL/NAVISTAR	7600	CATERPILLAR C12 DIESEL	2004-2004	INTERNATIONAL/NAVISTAR	9900IX	CATERPILLAR C15 DIESEL	2004-2007
STERLING	ACTERRA	CATERPILLAR C13 DIESEL	2004-2006	K081102			
STERLING	A-LINE	CATERPILLAR C11 DIESEL	2005-2006	DODGE	RAM-4000	V6, 5.9 L DIESEL	2003-2008
STERLING	A-LINE	CATERPILLAR C13 DIESEL	2004-2006	DODGE	RAM-4000	V6, 6.7 L DIESEL	2008-2013
STERLING	A-LINE	CATERPILLAR C15 DIESEL	2005-2006	INTERNATIONAL/NAVISTAR	4600	INTERNATIONAL/NAVISTAR T444 DIESEL	1995-1995
STERLING	L-LINE	CATERPILLAR C13 DIESEL	2004-2007	INTERNATIONAL/NAVISTAR	4700	INTERNATIONAL/NAVISTAR T444 DIESEL	1995-2002
STERLING	L-LINE	CATERPILLAR C15 DIESEL	2005-2007	INTERNATIONAL/NAVISTAR	4700	INTERNATIONAL/NAVISTAR T444 DIESEL	2001-2001
STERLING	L-LINE	CATERPILLAR C9 DIESEL	2005-2005	INTERNATIONAL/NAVISTAR	4800	INTERNATIONAL/NAVISTAR T444 DIESEL	1995-1997
K081020				INTERNATIONAL/NAVISTAR	4900	INTERNATIONAL/NAVISTAR T444 DIESEL	1995-1997



MASTER SERVICIO PESADO 2014

BANDAS

MARCA	MODELO	MOTOR	AÑOS	MARCA	MODELO	MOTOR	AÑOS
K081124				FORD	F-550 SUPER DUTY	FORD V8, 6.0 L DIESEL	2003-2007
INTERNATIONAL/NAVISTAR	3400	INTERNATIONAL/NAVISTAR T444 DIESEL	1998-1999	INTERNATIONAL/NAVISTAR	3800	INTERNATIONAL/NAVISTAR T444 DIESEL	1999-1999
INTERNATIONAL/NAVISTAR	3800	INTERNATIONAL/NAVISTAR T444 DIESEL	1998-2002	INTERNATIONAL/NAVISTAR	4600	INTERNATIONAL/NAVISTAR T444 DIESEL	1995-1995
INTERNATIONAL/NAVISTAR	4600	INTERNATIONAL/NAVISTAR T444 DIESEL	1995-1995	INTERNATIONAL/NAVISTAR	4700	INTERNATIONAL/NAVISTAR T444 DIESEL	1995-2002
INTERNATIONAL/NAVISTAR	4700	INTERNATIONAL/NAVISTAR T444 DIESEL	1995-2002	INTERNATIONAL/NAVISTAR	4800	INTERNATIONAL/NAVISTAR T444 DIESEL	1995-1997
INTERNATIONAL/NAVISTAR	4800	INTERNATIONAL/NAVISTAR T444 DIESEL	1995-1997	INTERNATIONAL/NAVISTAR	4900	INTERNATIONAL/NAVISTAR T444 DIESEL	1995-1997
INTERNATIONAL/NAVISTAR	4900	INTERNATIONAL/NAVISTAR T444 DIESEL	1995-1997	K081298			
INTERNATIONAL/NAVISTAR	CE	INTERNATIONAL/NAVISTAR T444 DIESEL	2003-2004	FORD	E450 SUPER DUTY	FORD V8, 6.0 L DIESEL	2003-2006
KENWORTH	C500	CATERPILLAR C15 DIESEL	2007-2008	K081325			
K081153				FORD	F-450 SUPER DUTY	FORD V8, 6.0 L DIESEL	2003-2007
FORD	F-650 SUPER DUTY	FORD V8, 7.3 L DIESEL	2000-2004	FORD	F-550 SUPER DUTY	FORD V8, 6.0 L DIESEL	2003-2007
FORD	F-750 SUPER DUTY	FORD V8, 7.3 L DIESEL	2000-2004	K081331			
K081177				INTERNATIONAL/NAVISTAR	CF500	INTERNATIONAL/NAVISTAR VT275 DIESEL	2005-2008
FORD	E450 SUPER DUTY	FORD V8, 7.3 L DIESEL	1998-1998	INTERNATIONAL/NAVISTAR	CF600	INTERNATIONAL/NAVISTAR VT275 DIESEL	2005-2008
K081196				K081359			
FORD	E450 SUPER DUTY	FORD V8, 7.3 L DIESEL	1998-1998	FORD	E450 SUPER DUTY	FORD V8, 6.0 L DIESEL	2003-2006
K081207				FORD	E450 SUPER DUTY	FORD V8, 7.3 L DIESEL	2002-2003
FORD	E450 SUPER DUTY	FORD V8, 7.3 L DIESEL	2002-2003	FORD	E450 SUPER DUTY	FORD V8, 7.3 L DIESEL	1998-1998
K081213				STERLING	BULLET	CUMMINS ISB-07 DIESEL	2008-2008
FORD	E450 SUPER DUTY	FORD V8, 7.3 L DIESEL	1998-1998	K081377			
FORD	E450 SUPER DUTY	FORD V8, 7.3 L DIESEL	1999-2003	FORD	F-450 SUPER DUTY	FORD V8, 7.3 L DIESEL	2000-2003
FORD	E550 SUPER DUTY	FORD V8, 7.3 L DIESEL	2002-2003	FORD	F-550 SUPER DUTY	FORD V8, 7.3 L DIESEL	2000-2004
FORD	F-450 SUPER DUTY	FORD V8, 7.3 L DIESEL	2002-2003	INTERNATIONAL/NAVISTAR	CONVENTIONAL IC	INTERNATIONAL/NAVISTAR T444 DIESEL	2003-2003
FORD	F-550 SUPER DUTY	FORD V8, 7.3 L DIESEL	2002-2004	K090609			
K081223				FREIGHTLINER	CENTURY CLASS	MERCEDES-BENZ MBE 4000 DIESEL	2004-2004
FORD	E550 SUPER DUTY	FORD V8, 7.3 L DIESEL	2002-2003	FREIGHTLINER	COLUMBIA	MERCEDES-BENZ MBE 4000 DIESEL	2003-2004
FORD	F-450 SUPER DUTY	FORD V8, 7.3 L DIESEL	2000-2003	FREIGHTLINER	FL112	MERCEDES-BENZ MBE 4000 DIESEL	2003-2004
FORD	F-450 SUPER DUTY	FORD V8, 7.3 L DIESEL	1999-2000	K090760			
FORD	F-450 SUPER DUTY	V8, 7.3 L	2001-2003	MERCEDES BENZ	MULTEGO	MULTEGO	2002-2009
FORD	F-550 SUPER DUTY	FORD V8, 7.3 L DIESEL	2000-2004	K090787			
FORD	F-550 SUPER DUTY	FORD V8, 7.3 L DIESEL	1999-2000	MERCEDES BENZ	CENTURY CLASS	CENTURY CLASS	2006-2010
FORD	F-650 SUPER DUTY	FORD V8, 7.3 L DIESEL	2000-2004	MERCEDES BENZ	TURICLASS	O-500-1841	2007-2010
FORD	F-750 SUPER DUTY	FORD V8, 7.3 L DIESEL	2000-2004	K090790			
INTERNATIONAL/NAVISTAR	4600	INTERNATIONAL/NAVISTAR T444 DIESEL	1995-1995	MERCEDES BENZ	MARCOPOLO ANDARE	O-500-1735	2007-2010
INTERNATIONAL/NAVISTAR	4700	INTERNATIONAL/NAVISTAR T444 DIESEL	1995-2002	K090806			
INTERNATIONAL/NAVISTAR	4800	INTERNATIONAL/NAVISTAR T444 DIESEL	1995-1997	MERCEDES BENZ	MARCOPOLO ANDARE	O-500-1735	2007-2010
INTERNATIONAL/NAVISTAR	4900	INTERNATIONAL/NAVISTAR T444 DIESEL	1995-1997	K100437			
K081264				VOLVO	VHD	VOLVO VE D12 DIESEL	2003-2004
DODGE	RAM-4000	V6, 5.9 L DIESEL	2008-2008	VOLVO	VNL	VOLVO VE 12 DIESEL	2000-2000
DODGE	RAM-4000	V6, 6.7 L DIESEL	2008-2013	VOLVO	VNL	VOLVO VE D12 DIESEL	1998-2003
K081265				VOLVO	VNM	VOLVO VE 12 DIESEL	2000-2000
DODGE	RAM-4000	V6, 5.9 L DIESEL	2003-2007	VOLVO	VNM	VOLVO VE D12 DIESEL	2002-2003
FORD	F-450 SUPER DUTY	FORD V8, 6.0 L DIESEL	2005-2006	K100456			
FORD	F-450 SUPER DUTY	FORD V8, 6.0 L DIESEL	2003-2007	INTERNATIONAL/NAVISTAR	9200	CUMMINS N14 DIESEL	1997-1997
FORD	F-550 SUPER DUTY	FORD V8, 6.0 L DIESEL	2006-2006	INTERNATIONAL/NAVISTAR	9300	CUMMINS N14 DIESEL	1997-1997



MASTER SERVICIO PESADO 2014

BANDAS

MARCA	MODELO	MOTOR	AÑOS	MARCA	MODELO	MOTOR	AÑOS
INTERNATIONAL/NAVISTAR	9400	CUMMINS N14 DIESEL	1997-1997	INTERNATIONAL/NAVISTAR	9100I	DETROIT DIESEL 6 CIL, 12.7 L DIESEL	2002-2002
K100465				INTERNATIONAL/NAVISTAR	9200I	DETROIT DIESEL 6 CIL, 12.7 L DIESEL	2002-2003
INTERNATIONAL/NAVISTAR	9100	CUMMINS N14 DIESEL	1999-1999	INTERNATIONAL/NAVISTAR	9400	DETROIT DIESEL 6 CIL, 11.1 L DIESEL	1995-1995
INTERNATIONAL/NAVISTAR	9100I	CUMMINS N14 DIESEL	2000-2003	INTERNATIONAL/NAVISTAR	9400	DETROIT DIESEL 6 CIL, 12.7 L DIESEL	1995-1995
INTERNATIONAL/NAVISTAR	9200	CUMMINS N14 DIESEL	1999-1999	INTERNATIONAL/NAVISTAR	9400	DETROIT DIESEL SERIE 60	1992-1999
INTERNATIONAL/NAVISTAR	9200I	CUMMINS N14 DIESEL	2003-2003	INTERNATIONAL/NAVISTAR	9400I	DETROIT DIESEL 6 CIL, 12.7 L DIESEL	2001-2003
INTERNATIONAL/NAVISTAR	9200I	CUMMINS N14 DIESEL	2000-2002	INTERNATIONAL/NAVISTAR	9400I	DETROIT DIESEL SERIE 60	2000-2000
INTERNATIONAL/NAVISTAR	9400	CUMMINS N14 DIESEL	1999-1999	INTERNATIONAL/NAVISTAR	9600	DETROIT DIESEL 6 CIL, 11.1 L DIESEL	1996-1996
INTERNATIONAL/NAVISTAR	9400I	CUMMINS N14 DIESEL	2003-2003	INTERNATIONAL/NAVISTAR	9600	DETROIT DIESEL 6 CIL, 12.7 L DIESEL	1995-1995
INTERNATIONAL/NAVISTAR	9400I	CUMMINS N14 DIESEL	2000-2002	INTERNATIONAL/NAVISTAR	9700	DETROIT DIESEL 6 CIL, 11.1 L DIESEL	1996-1996
INTERNATIONAL/NAVISTAR	9900	CUMMINS N14 DIESEL	1999-1999	INTERNATIONAL/NAVISTAR	9700	DETROIT DIESEL 6 CIL, 12.7 L DIESEL	1996-1996
INTERNATIONAL/NAVISTAR	9900I	CUMMINS N14 DIESEL	2003-2003	INTERNATIONAL/NAVISTAR	9800	DETROIT DIESEL SERIE 60	1997-1997
INTERNATIONAL/NAVISTAR	9900I	CUMMINS N14 DIESEL	2000-2002	INTERNATIONAL/NAVISTAR	9900	DETROIT DIESEL SERIE 60	1999-1999
INTERNATIONAL/NAVISTAR	9900IX	CUMMINS N14 DIESEL	2003-2003	INTERNATIONAL/NAVISTAR	9900I	DETROIT DIESEL 6 CIL, 12.7 L DIESEL	2001-2003
INTERNATIONAL/NAVISTAR	9900IX	CUMMINS N14 DIESEL	2000-2002	INTERNATIONAL/NAVISTAR	9900I	DETROIT DIESEL SERIE 60	2000-2000
K100502				INTERNATIONAL/NAVISTAR	9900IX	DETROIT DIESEL 6 CIL, 12.7 L DIESEL	2001-2002
FREIGHTLINER	CASCADIA	DETROIT DIESEL 6 CIL, 14.0 L DIESEL	2008-2010	INTERNATIONAL/NAVISTAR	9900IX	DETROIT DIESEL SERIE 60	2000-2000
FREIGHTLINER	CENTURY CLASS	DETROIT DIESEL 6 CIL, 11.1 L DIESEL	1999-1999	K100554			
FREIGHTLINER	CENTURY CLASS	DETROIT DIESEL 6 CIL, 12.7 L DIESEL	1999-2007	MACK	CX SERIES	MACK AC DIESEL	2003-2006
FREIGHTLINER	CENTURY CLASS	DETROIT DIESEL 6 CIL, 14.0 L DIESEL	2004-2007	MACK	LE SERIES	MACK AI DIESEL	2006-2006
FREIGHTLINER	CENTURY CLASS	DETROIT DIESEL SERIE 60	2005-2005	MACK	LE SERIES	MACK AMI DIESEL	2007-2007
FREIGHTLINER	CLASSIC	DETROIT DIESEL 6 CIL, 14.0 L DIESEL	2008-2008	MACK	MR SERIES	MACK AI DIESEL	2005-2006
FREIGHTLINER	CLASSIC XL	DETROIT DIESEL 6 CIL, 14.0 L DIESEL	2008-2008	MACK	MR SERIES	MACK AMI DIESEL	2003-2006
FREIGHTLINER	COLUMBIA	DETROIT DIESEL 6 CIL, 12.7 L DIESEL	2004-2009	MACK	MR SERIES	MACK AMI DIESEL	2007-2007
FREIGHTLINER	COLUMBIA	DETROIT DIESEL 6 CIL, 14.0 L DIESEL	2004-2011	VOLVO	VNL	VOLVO VE D16 DIESEL	2006-2008
FREIGHTLINER	COLUMBIA	DETROIT DIESEL SERIE 60	2005-2006	VOLVO	VNM	VOLVO VE D16 DIESEL	2006-2008
FREIGHTLINER	CORONADO	DETROIT DIESEL 6 CIL, 12.7 L DIESEL	2004-2008	VOLVO	VT SERIES	VOLVO VE D16 DIESEL	2006-2009
FREIGHTLINER	CORONADO	DETROIT DIESEL 6 CIL, 14.0 L DIESEL	2004-2010	K100557			
FREIGHTLINER	CORONADO	DETROIT DIESEL SERIE 60	2005-2006	FREIGHTLINER	COLUMBIA	DETROIT DIESEL 6 CIL, 14.0 L DIESEL	2011-2011
FREIGHTLINER	FLD	DETROIT DIESEL 6 CIL, 11.1 L DIESEL	1999-1999	K100570			
FREIGHTLINER	FLD	DETROIT DIESEL 6 CIL, 12.7 L DIESEL	1999-1999	INTERNATIONAL/NAVISTAR	9100	DETROIT DIESEL SERIE 60	1998-1999
FREIGHTLINER	FLD	DETROIT DIESEL 6 CIL, 14.0 L DIESEL	2008-2008	INTERNATIONAL/NAVISTAR	9100I	DETROIT DIESEL 6 CIL, 12.7 L DIESEL	2001-2003
STERLING	L-LINE	DETROIT DIESEL 6 CIL, 12.7 L DIESEL	2008-2008	INTERNATIONAL/NAVISTAR	9100I	DETROIT DIESEL SERIE 60	2000-2000
STERLING	L-LINE	DETROIT DIESEL 6 CIL, 14.0 L DIESEL	2008-2008	INTERNATIONAL/NAVISTAR	9200	DETROIT DIESEL SERIE 60	1998-1999
K100510				INTERNATIONAL/NAVISTAR	9200I	DETROIT DIESEL 6 CIL, 12.7 L DIESEL	2001-2001
INTERNATIONAL/NAVISTAR	9100	CUMMINS N14 DIESEL	1998-1998	INTERNATIONAL/NAVISTAR	9200I	DETROIT DIESEL SERIE 60	2000-2000
INTERNATIONAL/NAVISTAR	9200	CUMMINS N14 DIESEL	1997-1998	INTERNATIONAL/NAVISTAR	9300	DETROIT DIESEL 6 CIL, 11.1 L DIESEL	1995-1997
INTERNATIONAL/NAVISTAR	9300	CUMMINS N14 DIESEL	1997-1999	INTERNATIONAL/NAVISTAR	9300	DETROIT DIESEL 6 CIL, 12.7 L DIESEL	1995-1997
INTERNATIONAL/NAVISTAR	9400	CUMMINS N14 DIESEL	1997-1998	INTERNATIONAL/NAVISTAR	9300	DETROIT DIESEL SERIE 60	1998-1998
VOLVO	VNL	CUMMINS ISX DIESEL	2000-2003	INTERNATIONAL/NAVISTAR	9400	DETROIT DIESEL 6 CIL, 11.1 L DIESEL	1996-1996
VOLVO	VNL	CUMMINS SIGNATURE 600 DIESEL	2003-2003	INTERNATIONAL/NAVISTAR	9400	DETROIT DIESEL 6 CIL, 12.7 L DIESEL	1996-1996
VOLVO	VNM	CUMMINS ISX DIESEL	2002-2003	INTERNATIONAL/NAVISTAR	9400	DETROIT DIESEL SERIE 60	1997-1999
VOLVO	VNM	CUMMINS SIGNATURE 600 DIESEL	2003-2003	KENWORTH	T2000	CUMMINS SIGNATURE 600 DIESEL	1999-1999
K100540				K100572			
DINA	D-9400 EAGLE	DETROIT DIESEL SERIE 60, 12.7 L	1990-1992	VOLVO	VHD	VOLVO VE D12 DIESEL	2007-2009



MASTER SERVICIO PESADO 2014

BANDAS

MARCA	MODELO	MOTOR	AÑOS	MARCA	MODELO	MOTOR	AÑOS
K100578				MACK	MR SERIES	MACK 6 CIL, 12.0 L DIESEL	2001-2002
VOLVO	VNL	VOLVO D16 DIESEL	2009-2013	K100610			
VOLVO	VNL	VOLVO VE D16 DIESEL	2009-2009	MACK	LE SERIES	MACK AI DIESEL	2003-2005
VOLVO	VNM	VOLVO D16 DIESEL	2009-2013	K100630			
VOLVO	VNM	VOLVO VE D16 DIESEL	2009-2009	MACK	CXP SERIES	MACK MP7 DIESEL	2007-2007
K100579				VOLVO	VNL	CUMMINS N14 DIESEL	2000-2003
FREIGHTLINER	ARGOSY	DETROIT DIESEL 6 CIL, 11.1 L DIESEL	2000-2003	VOLVO	VNM	CUMMINS N14 DIESEL	2000-2003
FREIGHTLINER	ARGOSY	DETROIT DIESEL 6 CIL, 12.7 L DIESEL	2000-2008	K100637			
FREIGHTLINER	ARGOSY	DETROIT DIESEL 6 CIL, 14.0 L DIESEL	2001-2008	INTERNATIONAL/NAVISTAR	9200	DETROIT DIESEL 6 CIL, 11.1 L DIESEL	1995-1997
FREIGHTLINER	CLASSIC	DETROIT DIESEL 6 CIL, 12.7 L DIESEL	2004-2007	INTERNATIONAL/NAVISTAR	9200	DETROIT DIESEL 6 CIL, 12.7 L DIESEL	1995-1997
FREIGHTLINER	CLASSIC	DETROIT DIESEL 6 CIL, 14.0 L DIESEL	2004-2007	INTERNATIONAL/NAVISTAR	9400	DETROIT DIESEL 6 CIL, 11.1 L DIESEL	1996-1996
FREIGHTLINER	CLASSIC	DETROIT DIESEL SERIE 60	2005-2005	INTERNATIONAL/NAVISTAR	9400	DETROIT DIESEL 6 CIL, 12.7 L DIESEL	1996-1996
FREIGHTLINER	CLASSIC XL	DETROIT DIESEL 6 CIL, 12.7 L DIESEL	2004-2007	K100640			
FREIGHTLINER	CLASSIC XL	DETROIT DIESEL 6 CIL, 14.0 L DIESEL	2004-2007	INTERNATIONAL/NAVISTAR	8200	DETROIT DIESEL 6 CIL, 11.1 L DIESEL	1995-1995
FREIGHTLINER	CORONADO	DETROIT DIESEL 6 CIL, 12.7 L DIESEL	2002-2003	INTERNATIONAL/NAVISTAR	8200	DETROIT DIESEL 6 CIL, 12.7 L DIESEL	1995-1995
FREIGHTLINER	CORONADO	DETROIT DIESEL 6 CIL, 14.0 L DIESEL	2003-2003	INTERNATIONAL/NAVISTAR	9300	DETROIT DIESEL 6 CIL, 11.1 L DIESEL	1995-1997
FREIGHTLINER	FLD	DETROIT DIESEL 6 CIL, 12.7 L DIESEL	2004-2008	INTERNATIONAL/NAVISTAR	9300	DETROIT DIESEL 6 CIL, 12.7 L DIESEL	1995-1997
FREIGHTLINER	FLD	DETROIT DIESEL 6 CIL, 14.0 L DIESEL	2004-2007	INTERNATIONAL/NAVISTAR	9300	DETROIT DIESEL SERIE 60	1998-1998
FREIGHTLINER	FLD	DETROIT DIESEL SERIE 60	2006-2006	INTERNATIONAL/NAVISTAR	9400	DETROIT DIESEL 6 CIL, 11.1 L DIESEL	1996-1996
MACK	CXN SERIES	MACK AC DIESEL	2007-2007	INTERNATIONAL/NAVISTAR	9400	DETROIT DIESEL 6 CIL, 11.1 L DIESEL	1995-1995
MACK	CXN SERIES	MACK AC DIESEL	2006-2006	INTERNATIONAL/NAVISTAR	9400	DETROIT DIESEL 6 CIL, 12.7 L DIESEL	1996-1996
STERLING	A-LINE	DETROIT DIESEL 6 CIL, 12.7 L DIESEL	2004-2006	INTERNATIONAL/NAVISTAR	9400	DETROIT DIESEL 6 CIL, 12.7 L DIESEL	1995-1995
STERLING	A-LINE	DETROIT DIESEL 6 CIL, 14.0 L DIESEL	2004-2006	INTERNATIONAL/NAVISTAR	9400	DETROIT DIESEL SERIE 60	1997-1999
STERLING	A-LINE	DETROIT DIESEL SERIE 60	2004-2006	K100655			
STERLING	L-LINE	DETROIT DIESEL 6 CIL, 12.7 L DIESEL	2004-2007	MACK	CL SERIES	MACK 6 CIL, 12.0 L DIESEL	2001-2001
STERLING	L-LINE	DETROIT DIESEL 6 CIL, 14.0 L DIESEL	2004-2007	MACK	CV SERIES	MACK 6 CIL, 12.0 L DIESEL	2001-2002
STERLING	L-LINE	DETROIT DIESEL SERIE 60	2004-2006	MACK	DM SERIES	MACK 6 CIL, 12.0 L DIESEL	2001-2001
VOLVO	VHD	VOLVO VE 12 DIESEL	2002-2002	MACK	RD SERIES	MACK 6 CIL, 12.0 L DIESEL	2001-2002
VOLVO	VHD	VOLVO VE D12 DIESEL	2001-2006	K100658			
K100582				KENWORTH	T600	CUMMINS SIGNATURE 600 DIESEL	2003-2003
VOLVO	VNL	VOLVO VE D12 DIESEL	2004-2008	KENWORTH	T600	CUMMINS SIGNATURE 600 DIESEL	2003-2003
VOLVO	VNM	VOLVO VE D12 DIESEL	2006-2008	KENWORTH	T800	CUMMINS ISX DIESEL	1999-2002
K100594				MACK	CS SERIES	MACK AC DIESEL	2003-2003
VOLVO	9700	B13	2012-2014	MACK	CT SERIES	MACK AI DIESEL	2006-2007
K100607				MACK	CT SERIES	MACK AMI DIESEL	2006-2006
INTERNATIONAL/NAVISTAR	9400	DETROIT DIESEL 6 CIL, 11.1 L DIESEL	1995-1995	MACK	CV SERIES	MACK AI DIESEL	2003-2003
INTERNATIONAL/NAVISTAR	9400	DETROIT DIESEL 6 CIL, 12.7 L DIESEL	1995-1995	MACK	CV SERIES	MACK AMI DIESEL	2004-2004
INTERNATIONAL/NAVISTAR	9600	DETROIT DIESEL 6 CIL, 11.1 L DIESEL	1996-1996	K100665			
INTERNATIONAL/NAVISTAR	9600	DETROIT DIESEL 6 CIL, 12.7 L DIESEL	1995-1995	MACK	CT SERIES	MACK AMI DIESEL	2006-2006
INTERNATIONAL/NAVISTAR	9700	DETROIT DIESEL 6 CIL, 11.1 L DIESEL	1996-1996	MACK	CV SERIES	MACK AMI DIESEL	2003-2003
INTERNATIONAL/NAVISTAR	9700	DETROIT DIESEL 6 CIL, 12.7 L DIESEL	1996-1996	MACK	CX SERIES	MACK 6 CIL, 12.0 L DIESEL	2001-2001
INTERNATIONAL/NAVISTAR	9800	DETROIT DIESEL SERIE 60	1997-1997	VOLVO	VNL	CUMMINS ISM DIESEL	2003-2003
MACK	CV SERIES	MACK AI DIESEL	2005-2007	VOLVO	VNL	CUMMINS ISM DIESEL	1999-2000
MACK	CV SERIES	MACK AMI DIESEL	2004-2005	VOLVO	VNM	CUMMINS ISM DIESEL	2003-2003
MACK	CX SERIES	MACK 6 CIL, 12.0 L DIESEL	2002-2002	K100670			



MASTER SERVICIO PESADO 2014

BANDAS

MARCA	MODELO	MOTOR	AÑOS	MARCA	MODELO	MOTOR	AÑOS
KENWORTH	W900	CUMMINS ISX DIESEL	1999-2003	INTERNATIONAL/NAVISTAR	9400I	CATERPILLAR C15 DIESEL	2000-2003
KENWORTH	W900	CUMMINS SIGNATURE 600 DIESEL	2000-2002	INTERNATIONAL/NAVISTAR	9400I	CATERPILLAR C16 DIESEL	2000-2003
K100675				INTERNATIONAL/NAVISTAR	9900	CATERPILLAR 3406 DIESEL	1999-1999
KENWORTH	T2000	CUMMINS ISX DIESEL	1999-2003	INTERNATIONAL/NAVISTAR	9900I	CATERPILLAR 3406 DIESEL	2000-2000
K100677				INTERNATIONAL/NAVISTAR	9900I	CATERPILLAR C15 DIESEL	2000-2003
MACK	CH SERIES	MACK AC DIESEL	2003-2006	INTERNATIONAL/NAVISTAR	9900I	CATERPILLAR C16 DIESEL	2000-2003
K100702				INTERNATIONAL/NAVISTAR	9900IX	CATERPILLAR 3406 DIESEL	2000-2000
INTERNATIONAL/NAVISTAR	CE	INTERNATIONAL/NAVISTAR MAXXFORCE DT DIESEL	2011-2012	INTERNATIONAL/NAVISTAR	9900IX	CATERPILLAR C15 DIESEL	2000-2003
INTERNATIONAL/NAVISTAR	CE	INTERNATIONAL/NAVISTAR MAXXFORCE DT DIESEL	2009-2009	INTERNATIONAL/NAVISTAR	9900IX	CATERPILLAR C16 DIESEL	2000-2002
K100710				K100810			
FREIGHTLINER	ARGOSY	CUMMINS ISX DIESEL	1999-2003	STERLING	L-LINE	CUMMINS ISC DIESEL	2001-2001
FREIGHTLINER	CENTURY CLASS	CUMMINS ISX DIESEL	2001-2001	STERLING	L-LINE	CUMMINS ISX DIESEL	2001-2001
FREIGHTLINER	CENTURY CLASS	CUMMINS ISX DIESEL	2000-2000	STERLING	L-LINE	CUMMINS SIGNATURE 600 DIESEL	2001-2001
FREIGHTLINER	COLUMBIA	CUMMINS ISX DIESEL	2001-2001	STERLING	SILVER STAR	CUMMINS SIGNATURE 600 DIESEL	2001-2001
FREIGHTLINER	FLD	CUMMINS ISX DIESEL	2002-2003	K100817			
FREIGHTLINER	FLD	CUMMINS ISX DIESEL	1999-2001	VOLVO	9700	B13	2012-2014
MACK	CH SERIES	CUMMINS SIGNATURE 600 DIESEL	2001-2003	K100818			
MACK	CL SERIES	CUMMINS SIGNATURE 600 DIESEL	2001-2003	INTERNATIONAL/NAVISTAR	WORKSTAR 7400	INTERNATIONAL/NAVISTAR MAXXFORCE 9 DIESEL	2008-2009
K100719				K100822			
INTERNATIONAL/NAVISTAR	9100I	CUMMINS ISX DIESEL	2001-2003	INTERNATIONAL/NAVISTAR	WORKSTAR 7400	INTERNATIONAL/NAVISTAR MAXXFORCE 9 DIESEL	2010-2012
INTERNATIONAL/NAVISTAR	9200I	CUMMINS SIGNATURE 600 DIESEL	2000-2002	K100852			
INTERNATIONAL/NAVISTAR	9400I	CUMMINS ISX DIESEL	2000-2002	INTERNATIONAL/NAVISTAR	9300	CATERPILLAR 3406 DIESEL	1996-1998
INTERNATIONAL/NAVISTAR	9900I	CUMMINS ISX DIESEL	2000-2002	K100860			
INTERNATIONAL/NAVISTAR	9900IX	CUMMINS ISX DIESEL	2000-2003	INTERNATIONAL/NAVISTAR	DURASTAR 4300	INTERNATIONAL/NAVISTAR MAXXFORCE DT DIESEL	2008-2009
K100720				K100870			
INTERNATIONAL/NAVISTAR	CE	INTERNATIONAL/NAVISTAR MAXXFORCE DT DIESEL	2010-2010	INTERNATIONAL/NAVISTAR	DURASTAR 4300	INTERNATIONAL/NAVISTAR MAXXFORCE DT DIESEL	2011-2011
K100726				K100877			
INTERNATIONAL/NAVISTAR	CE	INTERNATIONAL/NAVISTAR MAXXFORCE DT DIESEL	2010-2010	INTERNATIONAL/NAVISTAR	DURASTAR 4300	INTERNATIONAL/NAVISTAR MAXXFORCE DT DIESEL	2013-2013
K100731				INTERNATIONAL/NAVISTAR	DURASTAR 4400	INTERNATIONAL/NAVISTAR MAXXFORCE DT DIESEL	2012-2013
INTERNATIONAL/NAVISTAR	CE	INTERNATIONAL/NAVISTAR MAXXFORCE DT DIESEL	2009-2009	K100891			
MACK	CH SERIES	MACK 6 CIL, 12.0 L DIESEL	2001-2002	VOLVO	VHD	CUMMINS ISM DIESEL	2002-2003
MACK	CTP SERIES	MACK MP7 DIESEL	2007-2007	VOLVO	VNL	CUMMINS ISM DIESEL	2002-2002
K100739				K100894			
KENWORTH	T800	CUMMINS ISX DIESEL	2003-2003	INTERNATIONAL/NAVISTAR	DURASTAR 4400	INTERNATIONAL/NAVISTAR MAXXFORCE DT DIESEL	2008-2011
K100745				K100922			
INTERNATIONAL/NAVISTAR	FE	INTERNATIONAL/NAVISTAR MAXXFORCE DT DIESEL	2010-2012	IRIZAR	MAN PANORAMICO	MAN PANORAMICO	2007-2010
K100764				K100946			
MACK	GU SERIES	MACK MP8 DIESEL	2008-2010	KENWORTH	T660	CATERPILLAR C13 DIESEL	2009-2013
K100771				KENWORTH	T800	CATERPILLAR C13 DIESEL	2008-2014
INTERNATIONAL/NAVISTAR	9100	CATERPILLAR 3406 DIESEL	1998-1998	KENWORTH	W900	CATERPILLAR C13 DIESEL	2008-2010
INTERNATIONAL/NAVISTAR	9200	CATERPILLAR 3406 DIESEL	1996-1998	K100953			
INTERNATIONAL/NAVISTAR	9200I	CATERPILLAR C15 DIESEL	2003-2004	FREIGHTLINER	BUSINESS CLASS M2	CATERPILLAR C13 DIESEL	2009-2010
INTERNATIONAL/NAVISTAR	9200I	CATERPILLAR C16 DIESEL	2003-2003	K100983			
INTERNATIONAL/NAVISTAR	9400	CATERPILLAR 3406 DIESEL	1996-1999	INTERNATIONAL/NAVISTAR	WORKSTAR 7400	INTERNATIONAL/NAVISTAR MAXXFORCE 9 DIESEL	2008-2009
INTERNATIONAL/NAVISTAR	9400I	CATERPILLAR 3406 DIESEL	2000-2000	K100983			



MASTER SERVICIO PESADO 2014

BANDAS

MARCA	MODELO	MOTOR	AÑOS	MARCA	MODELO	MOTOR	AÑOS
K101015				K120878			
INTERNATIONAL/NAVISTAR	WORKSTAR 7300	INTERNATIONAL/NAVISTAR MAXXFORCE DT DIESEL	2008-2009	KENWORTH	W900	CUMMINS ISX DIESEL	2004-2007
K101091				K120901			
INTERNATIONAL/NAVISTAR	RE	INTERNATIONAL/NAVISTAR MAXXFORCE DT DIESEL	2008-2012	INTERNATIONAL/NAVISTAR	9200I	CUMMINS ISX DIESEL	2003-2004
INTERNATIONAL/NAVISTAR	RE	INTERNATIONAL/NAVISTAR MAXXFORCE DT DIESEL	2009-2012	K120911			
K120433				INTERNATIONAL/NAVISTAR	9200	CUMMINS ISX DIESEL	2005-2005
STERLING	SILVER STAR	CUMMINS N14 DIESEL	2000-2000	INTERNATIONAL/NAVISTAR	9200I	CUMMINS ISX DIESEL	2005-2010
STERLING	TRACTO	CUMMINS N14 DIESEL	2000-2000	INTERNATIONAL/NAVISTAR	9400	CUMMINS ISX DIESEL	2005-2005
K120610				INTERNATIONAL/NAVISTAR	9400I	CUMMINS ISX DIESEL	2004-2007
VOLVO	VNL	VOLVO D16 DIESEL	2008-2008	KENWORTH	W900	CUMMINS ISX DIESEL	2010-2013
VOLVO	VNM	VOLVO D16 DIESEL	2008-2008	MACK	CL SERIES	CUMMINS ISX DIESEL	2004-2007
K120640				K120931			
MACK	CXU SERIES	MACK MP8 DIESEL	2008-2010	KENWORTH	W900	CUMMINS ISX DIESEL	2003-2003
VOLVO	VNL	VOLVO D13 DIESEL	2008-2014	K120964			
VOLVO	VNM	VOLVO D13 DIESEL	2008-2014	INTERNATIONAL/NAVISTAR	5500I	CUMMINS ISX DIESEL	2003-2007
K120720				INTERNATIONAL/NAVISTAR	5600	CUMMINS ISM DIESEL	2005-2005
DINA	MARCOPOLO PARADISO	DETROIT DIESEL SERIE 60, 12.7 L	1992-1997	INTERNATIONAL/NAVISTAR	5600I	CUMMINS ISX DIESEL	2005-2007
DINA	MARCOPOLO VIAGGIO GV1000	DETROIT DIESEL SERIE 60, 12.7 L	1994-1998	INTERNATIONAL/NAVISTAR	5900I	CUMMINS ISX DIESEL	2003-2007
NEOPLAN	NEOPLAN 2 PISOS	CUMMINS S60	1992-2000	INTERNATIONAL/NAVISTAR	PAYSTAR 5500I	CUMMINS ISX DIESEL	2008-2008
K120735				INTERNATIONAL/NAVISTAR	PAYSTAR 5900I	CUMMINS ISX DIESEL	2008-2008
NEOPLAN	NEOBUS	CUMMINS S60	2000-2006	K120979			
K120786				INTERNATIONAL/NAVISTAR	9000	CUMMINS ISX DIESEL	2004-2004
MACK	CHU SERIES	MACK MP8 DIESEL	2008-2010	INTERNATIONAL/NAVISTAR	9400I	CUMMINS ISX DIESEL	2003-2003
MACK	GRANITE	MACK MP8 DIESEL	2011-2013	INTERNATIONAL/NAVISTAR	9900	CUMMINS ISX DIESEL	2005-2005
MACK	GU SERIES	MACK MP8 DIESEL	2008-2010	INTERNATIONAL/NAVISTAR	9900I	CUMMINS ISX DIESEL	2003-2008
K120842				INTERNATIONAL/NAVISTAR	9900IX	CUMMINS ISX DIESEL	2004-2007
VOLVO	VNL	CUMMINS ISX DIESEL	2004-2013	INTERNATIONAL/NAVISTAR	9900IX	CUMMINS ISX DIESEL	2003-2003
VOLVO	VNL	CUMMINS ISX DIESEL	2003-2003	KENWORTH	T800	CATERPILLAR C15 DIESEL	2006-2009
VOLVO	VNL	CUMMINS SIGNATURE 600 DIESEL	2003-2003	KENWORTH	T800	CATERPILLAR C15 DIESEL	2010-2013
VOLVO	VNM	CUMMINS ISX DIESEL	2004-2013	K120980			
VOLVO	VNM	CUMMINS ISX DIESEL	2003-2003	KENWORTH	T660	CATERPILLAR C15 DIESEL	2007-2013
VOLVO	VT880	CUMMINS ISX DIESEL	2006-2006	K120985			
K120858				FREIGHTLINER	COLUMBIA	CATERPILLAR C15 DIESEL	2008-2009
KENWORTH	T800	CUMMINS ISX DIESEL	2013-2014	FREIGHTLINER	FLD	CATERPILLAR C15 DIESEL	2009-2010
K120864				K121049			
KENWORTH	T2000	CUMMINS ISX DIESEL	2004-2006	KENWORTH	W900	CATERPILLAR C15 DIESEL	2008-2010
KENWORTH	T600	CUMMINS ISX DIESEL	2002-2010	K140429			
KENWORTH	T800	CUMMINS ISX DIESEL	2004-2006	STERLING	A-LINE	CUMMINS N14 DIESEL	2000-2001
KENWORTH	T800	CUMMINS ISX DIESEL	2007-2007	STERLING	L-LINE	CUMMINS N14 DIESEL	2000-2001
K120870				K140433			
INTERNATIONAL/NAVISTAR	9200I	CUMMINS ISX DIESEL	2011-2013	STERLING	SILVER STAR	CATERPILLAR C15 DIESEL	2000-2000
INTERNATIONAL/NAVISTAR	PROSTAR SERIES	CUMMINS ISX DIESEL	2009-2012	K140496			
K120872				STERLING	A-LINE	DETROIT DIESEL 6 CIL, 11.1 L DIESEL	2000-2002
KENWORTH	T660	CUMMINS ISX DIESEL	2007-2014	STERLING	A-LINE	DETROIT DIESEL 6 CIL, 12.7 L DIESEL	2000-2002
KENWORTH	T800	CUMMINS ISX DIESEL	2008-2012	STERLING	A-LINE	DETROIT DIESEL SERIE 60	2001-2002



MASTER SERVICIO PESADO 2014

BANDAS

MARCA	MODELO	MOTOR	AÑOS	MARCA	MODELO	MOTOR	AÑOS
STERLING	L-LINE	DETROIT DIESEL 6 CIL, 11.1 L DIESEL	2000-2002	KENWORTH	T600	CUMMINS N14 DIESEL	1992-1996
STERLING	L-LINE	DETROIT DIESEL 6 CIL, 12.7 L DIESEL	2000-2002	KENWORTH	T800	CUMMINS N14 DIESEL	1992-1996
STERLING	L-LINE	DETROIT DIESEL SERIE 60	2001-2002	KENWORTH	T800	CUMMINS N14 DIESEL	2002-2003
STERLING	SILVER STAR	DETROIT DIESEL SERIE 60	2000-2000	KENWORTH	W900	CUMMINS N14 DIESEL	2002-2003
K140516				STERLING	A-LINE	CUMMINS N14 DIESEL	2001-2002
STERLING	A-LINE	CUMMINS ISM DIESEL	2000-2001	STERLING	L-LINE	CUMMINS N14 DIESEL	2001-2002
STERLING	L-LINE	CUMMINS ISM DIESEL	2000-2003	PQ17430			
K140580				FREIGHTLINER	FLC	CUMMINS N14 DIESEL	1992-1996
STERLING	A-LINE	CATERPILLAR 3406 DIESEL	2000-2001	FREIGHTLINER	FLD	CUMMINS N14 DIESEL	1992-1996
STERLING	A-LINE	CATERPILLAR C15 DIESEL	2000-2001	FREIGHTLINER	FLD120	CUMMINS NTC 350	1993-1993
STERLING	A-LINE	CATERPILLAR C16 DIESEL	2000-2000	INTERNATIONAL/NAVISTAR	5000	CUMMINS N14 DIESEL	1992-1998
STERLING	L-LINE	CATERPILLAR C15 DIESEL	2001-2002	INTERNATIONAL/NAVISTAR	PAYSTAR	CUMMINS N14 DIESEL	1992-1998
STERLING	L-LINE	CATERPILLAR C16 DIESEL	2001-2001	KENWORTH	K100	CUMMINS N14 DIESEL	1992-1993
STERLING	SILVER STAR	CATERPILLAR 3406 DIESEL	1999-2000	KENWORTH	T600	CATERPILLAR 3406 DIESEL	1990-1990
K140603				KENWORTH	T600	CUMMINS N14 DIESEL	2000-2001
STERLING	A-LINE	CATERPILLAR C10 DIESEL	2000-2001	KENWORTH	T800	CATERPILLAR 3406 DIESEL	1990-1990
STERLING	A-LINE	CATERPILLAR C12 DIESEL	2000-2001	KENWORTH	T800	CUMMINS N14 DIESEL	1997-2001
STERLING	L-LINE	CATERPILLAR C10 DIESEL	2000-2004	KENWORTH	W900	CUMMINS N14 DIESEL	1993-1996
STERLING	L-LINE	CATERPILLAR C12 DIESEL	2000-2004	KENWORTH	W900	CUMMINS N14 DIESEL	1997-2001
K140662				MERCEDES BENZ	1517	OM 366	1990-1994
STERLING	L-LINE	CATERPILLAR 3406 DIESEL	2000-2001	STERLING	SILVER STAR	CUMMINS N14 DIESEL	2000-2000
K140682				STERLING	TRACTO	CUMMINS N14 DIESEL	2000-2000
STERLING	L-LINE	CATERPILLAR C10 DIESEL	2002-2002	PQ17440			
STERLING	L-LINE	CATERPILLAR C12 DIESEL	2002-2002	DINA	D-9400 EAGLE	CUMMINS NTC 400	1990-1994
K150759				DINA	S-700	CUMMINS 400	1990-1997
FREIGHTLINER	FLD	CUMMINS SIGNATURE 600 DIESEL	1998-1999	FREIGHTLINER	CENTURY CLASS	CUMMINS N14 DIESEL	1996-1998
PQ17400				FREIGHTLINER	CENTURY CLASS	CUMMINS N14 DIESEL	1998-2001
INTERNATIONAL/NAVISTAR	9400	CUMMINS N14 DIESEL	1993-1993	FREIGHTLINER	FLC	CUMMINS N14 DIESEL	1992-1997
INTERNATIONAL/NAVISTAR	9400	CUMMINS N14 DIESEL	1994-1996	FREIGHTLINER	FLD	CUMMINS N14 DIESEL	1992-1996
KENWORTH	K100	CUMMINS N14 DIESEL	1992-1993	FREIGHTLINER	FLD	CUMMINS N14 DIESEL	1997-2001
KENWORTH	T600	CUMMINS N14 DIESEL	1992-1996	FREIGHTLINER	FLD120	CUMMINS N14 DIESEL	1993-1997
KENWORTH	T800	CUMMINS N14 DIESEL	1992-1996	SCANIA	SCANIA	K113	1994-2000
KENWORTH	W900	CUMMINS NTC 300	1990-1990	PQ17450			
KENWORTH	W900	CUMMINS NTC 300	1990-1990	DINA	D-9400	CUMMINS N14 DIESEL	1990-1994
MERCEDES BENZ	1317	OM 366	1990-1994	DODGE	D-600	DODGE V8, 5.9 L	1993-1994
PQ17420				FREIGHTLINER	CENTURY CLASS	CUMMINS N14 DIESEL	1996-2001
FORD	F-800	CUMMINS ISB DIESEL	1998-1998	FREIGHTLINER	FLC	CUMMINS N14 DIESEL	1992-1996
FREIGHTLINER	FLC	CUMMINS N14 DIESEL	1992-1996	FREIGHTLINER	FLC	CUMMINS N14 DIESEL	1997-1997
FREIGHTLINER	FLD	CUMMINS N14 DIESEL	1992-1996	FREIGHTLINER	FLC	CUMMINS N14 DIESEL	1992-1996
ISUZU	ELF 400	4HK1-TC	2006-2013	FREIGHTLINER	FLD	CUMMINS N14 DIESEL	1992-1996
ISUZU	ELF 450	4HK1-TC	2006-2008	FREIGHTLINER	FLD	CUMMINS N14 DIESEL	2001-2001
ISUZU	ELF 500	4HK1-TC	2009-2013	FREIGHTLINER	FLD	CUMMINS N14 DIESEL	1992-1996
ISUZU	ELF 600	4HK1-TC	2009-2013	FREIGHTLINER	FLD120	CUMMINS N14 DIESEL	1993-1997
ISUZU	ELF 600-BUS	4HK1-TC	2011-2013	INTERNATIONAL/NAVISTAR	5000	CATERPILLAR C12 DIESEL	2000-2000
KENWORTH	T2000	CUMMINS N14 DIESEL	1998-2000	INTERNATIONAL/NAVISTAR	5000	CUMMINS N14 DIESEL	1992-2000



MASTER SERVICIO PESADO 2014

BANDAS

MARCA	MODELO	MOTOR	AÑOS	MARCA	MODELO	MOTOR	AÑOS
INTERNATIONAL/NAVISTAR	9400	CUMMINS N14 DIESEL	1994-1996	KENWORTH	W900	DETROIT DIESEL SERIE 60	1997-2000
INTERNATIONAL/NAVISTAR	9400	CUMMINS NTC 400	1990-1990	KENWORTH	W900	DETROIT DIESEL SERIE 60, 11.1	1991-1996
INTERNATIONAL/NAVISTAR	PAYSTAR	CATERPILLAR C10 DIESEL	2000-2000	KENWORTH	W900	DETROIT DIESEL SERIE 60, 12.7	1991-1996
INTERNATIONAL/NAVISTAR	PAYSTAR	CATERPILLAR C12 DIESEL	2000-2000	MASA	PREMIER	DETROIT DIESEL SERIE 60	1993-1996
INTERNATIONAL/NAVISTAR	PAYSTAR	CUMMINS N14 DIESEL	1992-2000	MASA	PREMIER	DETROIT DIESEL V6	1993-1996
KENWORTH	T600	CUMMINS ISC 260	2001-2001	MERCEDES BENZ	0371 RS	OM 447	1990-1998
KENWORTH	T600	CUMMINS N14 DIESEL	1997-2001			PQ17480	
KENWORTH	T600	DETROIT DIESEL SERIE 60	1990-1999	DINA	AVANTE	DETROIT DIESEL V6	1990-1992
KENWORTH	T800	CUMMINS N14 DIESEL	1998-2003	KENWORTH	T800	DETROIT DIESEL SERIE 60, 11.1	1990-1990
KENWORTH	T800	DETROIT DIESEL SERIE 60	1990-1999	KENWORTH	T800	DETROIT DIESEL SERIE 60, 12.7	1990-1990
KENWORTH	T800	DETROIT DIESEL SERIE 60, 11.1	1992-1995	STERLING	SILVER STAR	CATERPILLAR 3406 DIESEL	1999-2000
KENWORTH	T800	DETROIT DIESEL SERIE 60, 12.7	1992-1995	STERLING	SILVER STAR	CATERPILLAR 3406 DIESEL	1999-2000
KENWORTH	W900	CUMMINS N14 DIESEL	1998-2003	STERLING	SILVER STAR	CATERPILLAR C15 DIESEL	2000-2000
SCANIA	SCANIA	DSC11-22	1992-1998	VOLVO	VNM	CATERPILLAR 3406 DIESEL	1997-1998
SCANIA	SCANIA PARADISO	K112	1992-2000			PQ17490	
VOLVO	VNM	CUMMINS N14 DIESEL	1998-1999	KENWORTH	T600	DETROIT DIESEL SERIE 60	1990-1994
		PQ17460		KENWORTH	T800	DETROIT DIESEL SERIE 60	1990-1994
DINA	D-9400 EAGLE	CUMMINS NTC 400	1990-1994	KENWORTH	W900	DETROIT DIESEL SERIE 60	1990-1993
DINA	S-700	CUMMINS 350	1990-1997	KENWORTH	W900	DETROIT DIESEL SERIE 60, 11.1	1990-1996
FREIGHTLINER	FLC	CUMMINS N14 DIESEL	1992-1996	KENWORTH	W900	DETROIT DIESEL SERIE 60, 12.7	1990-1996
FREIGHTLINER	FLD	CUMMINS N14 DIESEL	1992-2000	MASA	ESTRADA	DETROIT DIESEL SERIE 50	1997-1997
FREIGHTLINER	FLD120	CUMMINS NTC 350	1993-1993	MERCEDES BENZ	AUTOBUS INTEGRAL	OM 355 LA	1991-1991
INTERNATIONAL/NAVISTAR	9400	CUMMINS N14 DIESEL	1993-1993	STERLING	SILVER STAR	CATERPILLAR C15 DIESEL	2000-2000
KENWORTH	T2000	CUMMINS N14 DIESEL	1996-1996			PQ17500	
KENWORTH	T600	CATERPILLAR 3406 DIESEL	1990-1990	FREIGHTLINER	CENTURY CLASS	DETROIT DIESEL SERIE 60	1997-2003
KENWORTH	T600	CUMMINS N14 DIESEL	1992-1996	FREIGHTLINER	COLUMBIA	DETROIT DIESEL SERIE 60	2001-2003
KENWORTH	T800	CATERPILLAR 3406 DIESEL	1990-1990	FREIGHTLINER	FLC	DETROIT DIESEL SERIE 60	1997-1997
KENWORTH	T800	CUMMINS N14 DIESEL	1992-1997	FREIGHTLINER	FLD	CATERPILLAR C10 DIESEL	1996-1996
KENWORTH	T800	CUMMINS NTC 350	1991-1991	KENWORTH	T2000	DETROIT DIESEL SERIE 60	2000-2000
KENWORTH	W900	CUMMINS N14 DIESEL	1993-1997	KENWORTH	T400	CATERPILLAR 3306 DIESEL	1990-1990
MERCEDES BENZ	BUSSCAR	MB 906	2002-2008	KENWORTH	T450	CATERPILLAR 3306 DIESEL	1990-1990
		PQ17470		KENWORTH	T600	CUMMINS NTC 400	1993-1993
KENWORTH	K100	CUMMINS N14 DIESEL	1992-1993	KENWORTH	T600	DETROIT DIESEL SERIE 60	1990-1991
KENWORTH	T2000	DETROIT DIESEL SERIE 60	1998-2000	KENWORTH	T600	DETROIT DIESEL SERIE 60	1990-1994
KENWORTH	T2000	DETROIT DIESEL SERIE 60, 11.1	1997-1999	KENWORTH	T800	DETROIT DIESEL SERIE 60	1990-1994
KENWORTH	T2000	DETROIT DIESEL SERIE 60, 12.7	1997-1999	MERCEDES BENZ	0371 RS	OM 355	1990-1998
KENWORTH	T600	CUMMINS N14 DIESEL	1992-1996	VOLVO	7350	D7C	2002-2002
KENWORTH	T600	DETROIT DIESEL SERIE 60	1990-1994	VOLVO	VNM	CATERPILLAR 3406 DIESEL	1997-1998
KENWORTH	T800	CATERPILLAR 3306 DIESEL	1990-1990			PQ17510	
KENWORTH	T800	CUMMINS N14 DIESEL	1992-1996	FREIGHTLINER	CENTURY CLASS	DETROIT DIESEL SERIE 60	1999-1999
KENWORTH	T800	DETROIT DIESEL SERIE 60	1990-1994	FREIGHTLINER	CENTURY CLASS	DETROIT DIESEL SERIE 60	1998-1999
KENWORTH	T800	DETROIT DIESEL SERIE 60, 11.1	1990-1995	FREIGHTLINER	CENTURY CLASS	DETROIT DIESEL SERIE 60	1997-2000
KENWORTH	T800	DETROIT DIESEL SERIE 60, 12.7	1990-1995	FREIGHTLINER	FLC	CATERPILLAR 3406 DIESEL	1990-1990
KENWORTH	W900	CUMMINS N14 DIESEL	1993-1996	FREIGHTLINER	FLC	CUMMINS L10 DIESEL	1990-1993
KENWORTH	W900	CUMMINS NTC 300	1990-1990	FREIGHTLINER	FLC	DETROIT DIESEL SERIE 60	1990-1990



MASTER SERVICIO PESADO 2014

BANDAS

MARCA	MODELO	MOTOR	AÑOS	MARCA	MODELO	MOTOR	AÑOS
FREIGHTLINER	FLC	DETROIT DIESEL SERIE 60	1997-1997	FREIGHTLINER	FLD	CUMMINS L10 DIESEL	1990-1993
FREIGHTLINER	FLD	CUMMINS L10 DIESEL	1990-1993	FREIGHTLINER	FLD	DETROIT DIESEL SERIE 60	1990-1995
FREIGHTLINER	FLD	DETROIT DIESEL SERIE 60	1990-1990	FREIGHTLINER	FLD	DETROIT DIESEL SERIE 60	1990-2001
FREIGHTLINER	FLD	DETROIT DIESEL SERIE 60	2000-2000	FREIGHTLINER	FLD120	CUMMINS M11 DIESEL	1994-1994
FREIGHTLINER	FLD	DETROIT DIESEL SERIE 60	1994-1994	FREIGHTLINER	FLD120	DETROIT DIESEL SERIE 60	1991-1997
FREIGHTLINER	FLD	DETROIT DIESEL SERIE 60	1990-1998	INTERNATIONAL/NAVISTAR	5000	CUMMINS L10 DIESEL	1990-1991
KENWORTH	T800	DETROIT DIESEL SERIE 60, 11.1	1990-1991	INTERNATIONAL/NAVISTAR	PAYSTAR	CUMMINS L10 DIESEL	1990-1991
KENWORTH	T800	L DETROIT DIESEL SERIE 60, 12.7	1990-1991	KENWORTH	K100	DETROIT DIESEL SERIE 60	1991-1993
KENWORTH	W900	L DETROIT DIESEL SERIE 60	1990-1993	KENWORTH	K100	DETROIT DIESEL SERIE 60, 11.1	1991-1993
KENWORTH	W900	L DETROIT DIESEL SERIE 60, 11.1	1990-1991	KENWORTH	K100	L DETROIT DIESEL SERIE 60, 12.7	1991-1993
KENWORTH	W900	L DETROIT DIESEL SERIE 60, 12.7	1990-1991	KENWORTH	T2000	L DETROIT DIESEL SERIE 60	1998-1999
MASA	ESTRADA	DETROIT DIESEL SERIE 60	1997-2000	KENWORTH	T400	CUMMINS L10 DIESEL	1990-1997
MERCEDES BENZ	AUTOBUS INTEGRAL	OM 355 LA	1991-1991	KENWORTH	T400	CUMMINS M11 DIESEL	1995-1997
MERCEDES BENZ	AUTOBUS INTEGRAL	OM 447 LA	1992-1992	KENWORTH	T400A	CUMMINS L10 DIESEL	1993-1994
VOLVO	7350	D7C	2002-2002	KENWORTH	T400A	CUMMINS L10 DIESEL	1995-1995
VOLVO	VNM	CATERPILLAR 3406 DIESEL	1999-1999	KENWORTH	T400A	CUMMINS M11 DIESEL	1994-1995
		PQ17520		KENWORTH	T450	CUMMINS L10 DIESEL	1990-1995
DINA	AVANTE	DETROIT DIESEL V8	1990-1992	KENWORTH	T450	CUMMINS M11 DIESEL	1990-1999
FREIGHTLINER	FLD	DETROIT DIESEL SERIE 60	1996-2003	KENWORTH	T600	CUMMINS L10 DIESEL	1990-1997
KENWORTH	T2000	CUMMINS M11 DIESEL	1996-1996	KENWORTH	T600	CUMMINS M11 DIESEL	1995-1998
KENWORTH	T2000	DETROIT DIESEL SERIE 60, 11.1	1997-1999	KENWORTH	T600	DETROIT DIESEL SERIE 60	1992-1996
KENWORTH	T2000	L DETROIT DIESEL SERIE 60, 12.7	1997-1999	KENWORTH	T600	DETROIT DIESEL SERIE 60	1990-1994
KENWORTH	T600	L CATERPILLAR 3406 DIESEL	1990-1990	KENWORTH	T600A	CUMMINS L10 DIESEL	1993-1995
KENWORTH	T600	DETROIT DIESEL SERIE 60	1990-1994	KENWORTH	T800	CATERPILLAR 3306 DIESEL	1990-1990
KENWORTH	T600	DETROIT DIESEL SERIE 60	1995-1999	KENWORTH	T800	CUMMINS L10 DIESEL	1990-1997
KENWORTH	T800	CATERPILLAR 3406 DIESEL	1990-1990	KENWORTH	T800	CUMMINS M11 DIESEL	1995-1998
KENWORTH	T800	DETROIT DIESEL SERIE 60	1990-1994	KENWORTH	T800	CUMMINS M11 DIESEL	2000-2000
KENWORTH	T800	DETROIT DIESEL SERIE 60	1995-1999	KENWORTH	T800	DETROIT DIESEL SERIE 60	1990-1994
KENWORTH	T800	DETROIT DIESEL SERIE 60, 11.1	1993-1995	KENWORTH	T800	DETROIT DIESEL SERIE 60, 11.1	1991-1992
KENWORTH	T800	L DETROIT DIESEL SERIE 60, 11.1	1992-1994	KENWORTH	T800	L DETROIT DIESEL SERIE 60, 11.1	1991-1991
KENWORTH	T800	L DETROIT DIESEL SERIE 60, 12.7	1993-1995	KENWORTH	T800	L DETROIT DIESEL SERIE 60, 12.7	1991-1992
KENWORTH	T800	L DETROIT DIESEL SERIE 60, 12.7	1992-1994	KENWORTH	T800	L DETROIT DIESEL SERIE 60, 12.7	1991-1991
KENWORTH	W900	L DETROIT DIESEL SERIE 60	1997-1999	KENWORTH	W900	L CATERPILLAR 3406 DIESEL	1990-1990
KENWORTH	W900	L DETROIT DIESEL SERIE 60, 11.1	1991-1991	KENWORTH	W900	L DETROIT DIESEL SERIE 60, 11.1	1992-1996
KENWORTH	W900	L DETROIT DIESEL SERIE 60, 11.1	1992-1996	KENWORTH	W900	L DETROIT DIESEL SERIE 60, 12.7	1992-1996
KENWORTH	W900	L DETROIT DIESEL SERIE 60, 12.7	1991-1991	MERCEDES BENZ	1114	OM 366	1990-1994
KENWORTH	W900	L DETROIT DIESEL SERIE 60, 12.7	1992-1996	MERCEDES BENZ	1314	OM 366	1990-1994
		PQ17530		MERCEDES BENZ	1417	OM 366	1990-1994
DINA	S-400	PERKINS 5.8 L DIESEL	1990-1997	MERCEDES BENZ	1517	OM 366	1990-1994
DINA	S-500 CORAZA	PERKINS 5.8 L DIESEL	1990-1997	MERCEDES BENZ	1521	OM 366	1990-1994
DINA	S-500 CORAZA	PERKINS FASE IV C6-354.4 (5.8)	1990-1990	MERCEDES BENZ	2121	OM 366	1990-1994
FREIGHTLINER	CENTURY CLASS	L CATERPILLAR C12 DIESEL	1996-1996			PQ17540	
FREIGHTLINER	FLC	CUMMINS L10 DIESEL	1990-1993	FREIGHTLINER	FLC	CUMMINS N14 DIESEL	1992-1996
FREIGHTLINER	FLC	CUMMINS L10 DIESEL	1990-1993	FREIGHTLINER	FLD	CUMMINS N14 DIESEL	1992-1995
FREIGHTLINER	FLD	CUMMINS L10 DIESEL	1990-1993	FREIGHTLINER	FLD120	CUMMINS M11 DIESEL	1995-1996



MASTER SERVICIO PESADO 2014

BANDAS

MARCA	MODELO	MOTOR	AÑOS	MARCA	MODELO	MOTOR	AÑOS
KENWORTH	T450B	CUMMINS L10 DIESEL	1992-1994	DINA	S-600	INTERNATIONAL/NAVISTAR DT466	1990-1997
KENWORTH	T600	DETROIT DIESEL SERIE 60	1990-1991			PQ24895	
KENWORTH	T600	DETROIT DIESEL SERIE 60	1992-1996	MASA	ESTRADA	DETROIT DIESEL SERIE 60	1997-2000
KENWORTH	T800	CATERPILLAR 3306 DIESEL	1990-1990	MASA	PREMIER	DETROIT DIESEL V6	1993-1996
KENWORTH	T800	DETROIT DIESEL SERIE 60, 11.1 L	1990-1991			PQ28400	
KENWORTH	T800	DETROIT DIESEL SERIE 60, 12.7 L	1990-1991	KENWORTH	K100	CUMMINS N14 DIESEL	1992-1993
KENWORTH	W900	DETROIT DIESEL SERIE 60, 11.1 L	1991-1991	KENWORTH	T600	CUMMINS N14 DIESEL	1992-1996
KENWORTH	W900	DETROIT DIESEL SERIE 60, 11.1 L	1990-1990	KENWORTH	T800	CUMMINS N14 DIESEL	1992-1996
KENWORTH	W900	DETROIT DIESEL SERIE 60, 12.7 L	1991-1991			PQ28412	
KENWORTH	W900	DETROIT DIESEL SERIE 60, 12.7 L	1990-1990	FREIGHTLINER	CENTURY CLASS	CUMMINS N14 DIESEL	1998-2001
MERCEDES BENZ	1517	OM 366	1990-1994	FREIGHTLINER	CENTURY CLASS	CUMMINS N14 DIESEL	1996-1998
SCANIA	SCANIA	K113	1994-2000	FREIGHTLINER	FLC	CUMMINS N14 DIESEL	1997-1997
VOLVO	VNM	CUMMINS M11 DIESEL	1997-1998	KENWORTH	T2000	CUMMINS N14 DIESEL	1998-2000
		PQ17550		KENWORTH	T2000	CUMMINS N14 DIESEL	1996-1996
FREIGHTLINER	CENTURY CLASS	CUMMINS M11 DIESEL	1996-1998	KENWORTH	T600	CUMMINS N14 DIESEL	1992-1996
FREIGHTLINER	FLC	CATERPILLAR 3406 DIESEL	1990-1990	KENWORTH	T600	CUMMINS NTC 400	1993-1993
FREIGHTLINER	FLC	CUMMINS L10 DIESEL	1990-1993	KENWORTH	T800	CUMMINS N14 DIESEL	1992-1996
FREIGHTLINER	FLC	CUMMINS M11 DIESEL	1995-1997	KENWORTH	T800	CUMMINS NTC 350	1991-1991
FREIGHTLINER	FLC	DETROIT DIESEL SERIE 60	1990-1990			PQ28423	
FREIGHTLINER	FLD	CATERPILLAR 3406 DIESEL	1990-1990	INTERNATIONAL/NAVISTAR	5000	CUMMINS N14 DIESEL	1992-1993
FREIGHTLINER	FLD	CUMMINS L10 DIESEL	1990-1993	INTERNATIONAL/NAVISTAR	PAYSTAR	CUMMINS N14 DIESEL	1992-1993
FREIGHTLINER	FLD	CUMMINS M11 DIESEL	1995-1998			PQ28429	
FREIGHTLINER	FLD	CUMMINS N14 DIESEL	1996-1996	FREIGHTLINER	CENTURY CLASS	CUMMINS N14 DIESEL	1997-1997
KENWORTH	K100	DETROIT DIESEL SERIE 60	1991-1993	FREIGHTLINER	FLC	CUMMINS N14 DIESEL	1992-1996
KENWORTH	K100	DETROIT DIESEL SERIE 60, 11.1 L	1991-1993	FREIGHTLINER	FLD	CUMMINS N14 DIESEL	1997-2001
KENWORTH	K100	DETROIT DIESEL SERIE 60, 12.7 L	1991-1993	FREIGHTLINER	FLD	CUMMINS N14 DIESEL	1992-1996
KENWORTH	T400	CUMMINS L10 DIESEL	1990-1993	FREIGHTLINER	FLD120	CUMMINS N14 DIESEL	1993-1993
KENWORTH	T600	DETROIT DIESEL SERIE 60	1990-1994	INTERNATIONAL/NAVISTAR	9400	CUMMINS NTC 400	1990-1990
KENWORTH	T800	DETROIT DIESEL SERIE 60	1990-1994	KENWORTH	T600	CUMMINS N14 DIESEL	1992-1996
KENWORTH	W900	CATERPILLAR 3406 DIESEL	1990-1990	KENWORTH	T800	CUMMINS N14 DIESEL	1992-1996
KENWORTH	W900	DETROIT DIESEL SERIE 60	1990-1993	KENWORTH	W900	CUMMINS NTC 300	1990-1990
VOLVO	VNL 64T	DETROIT DIESEL SERIE 60	1999-2000			PQ28437	
VOLVO	VNM	DETROIT DIESEL SERIE 60	1998-2000	FREIGHTLINER	FLC	CUMMINS N14 DIESEL	1992-1996
		PQ24434		FREIGHTLINER	FLD	CUMMINS N14 DIESEL	1992-1996
FREIGHTLINER	FLD120	CUMMINS N14 DIESEL	2000-2000	FREIGHTLINER	FLD120	CUMMINS N14 DIESEL	1994-1997
KENWORTH	K100	CUMMINS N14 DIESEL	1992-1993	FREIGHTLINER	FLD120	CUMMINS NTC 350	1993-1993
		PQ24545		KENWORTH	T600	CATERPILLAR 3406 DIESEL	1990-1990
KENWORTH	T600	CATERPILLAR 3406 DIESEL	1990-1990	KENWORTH	T600	CUMMINS N14 DIESEL	1997-2001
KENWORTH	T800	CATERPILLAR 3406 DIESEL	1990-1990	KENWORTH	T600	CUMMINS N14 DIESEL	1992-1996
		PQ24570		KENWORTH	T800	CATERPILLAR 3406 DIESEL	1990-1990
KENWORTH	T600	CATERPILLAR 3406 DIESEL	1990-1990	KENWORTH	T800	CUMMINS N14 DIESEL	1998-2002
KENWORTH	T800	CATERPILLAR 3406 DIESEL	1990-1990	KENWORTH	T800	CUMMINS N14 DIESEL	1992-1996
KENWORTH	W900	CATERPILLAR 3406 DIESEL	1990-1990			PQ28445	
		PQ24710		FREIGHTLINER	FLC	CUMMINS N14 DIESEL	1992-1996
DINA	S-600	CUMMINS 8.3 L DIESEL	1990-1997	FREIGHTLINER	FLD	CUMMINS N14 DIESEL	1992-1996



MASTER SERVICIO PESADO 2014

BANDAS

MARCA	MODELO	MOTOR	AÑOS	MARCA	MODELO	MOTOR	AÑOS
PQ28463				GIANT MOTORS	GF-8	4 CIL, 1.0 L	2007-2008
INTERNATIONAL/NAVISTAR	9400	CUMMINS N14 DIESEL	1993-1993	GIANT MOTORS	GF-900	4 CIL, 1.0 L	2007-2008
INTERNATIONAL/NAVISTAR	9400	CUMMINS N14 DIESEL	1993-1993	T1095			
INTERNATIONAL/NAVISTAR	9400	CUMMINS N14 DIESEL	1994-1996	RENAULT	KANGOO	4 CIL, 1.6 L	2005-2013
INTERNATIONAL/NAVISTAR	9400	CUMMINS NTC 400	1990-1990	RENAULT	KANGOO EXPRESS	4 CIL, 1.6 L	2005-2008
KENWORTH	T800	CUMMINS N14 DIESEL	2002-2003	T1096			
PQ28473				HYUNDAI	H100	4 CIL, 2.5 L DIESEL	2009-2014
FREIGHTLINER	FLC	CUMMINS N14 DIESEL	1992-1996	HYUNDAI	H100	4 CIL, 2.5 L DIESEL	2006-2008
FREIGHTLINER	FLD	CUMMINS N14 DIESEL	1992-1996	HYUNDAI	H100 VAN/WAGON	4 CIL, 2.5 L DIESEL	2009-2013
INTERNATIONAL/NAVISTAR	9400	CUMMINS N14 DIESEL	1993-1993	T124			
KENWORTH	W900	CUMMINS N14 DIESEL	2003-2003	HYUNDAI	H100	4 CIL, 2.4 L	2003-2005
PQ28480				T1502			
FREIGHTLINER	FLC	CUMMINS N14 DIESEL	1992-1996	CHEVROLET	LUV	4 CIL, 2.2 L	2001-2003
FREIGHTLINER	FLD	CUMMINS N14 DIESEL	1992-1996	T1548			
FREIGHTLINER	FLD120	CUMMINS N14 DIESEL	2000-2000	VOLKSWAGEN	SAVEIRO	4 CIL, 1.6 L	2010-2013
KENWORTH	W900	CUMMINS N14 DIESEL	1993-1996	T1558			
PQ28483				RENAULT	TRAFIC	4 CIL, 1.9 L DIESEL	2009-2009
DINA	D-9400	CUMMINS N14 DIESEL	1990-1994	RENAULT	TRAFIC	4 CIL, 1.9 L DIESEL	2008-2008
KENWORTH	T800	CUMMINS N14 DIESEL	1997-1997	T1581			
KENWORTH	W900	CUMMINS N14 DIESEL	1997-2001	PEUGEOT	PARTNER	4 CIL, 1.6 L	2004-2011
PQ28492				T159			
DINA	S-700	CUMMINS 400	1990-1997	HYUNDAI	H100	4 CIL, 2.4 L	2003-2005
FREIGHTLINER	FLC	CUMMINS N14 DIESEL	1992-1996	T1603			
FREIGHTLINER	FLD	CUMMINS N14 DIESEL	1992-1996	PEUGEOT	EXPERT	4 CIL, 2.0 L HDI	2008-2010
INTERNATIONAL/NAVISTAR	5000	CUMMINS N14 DIESEL	1992-1993	T1653			
INTERNATIONAL/NAVISTAR	PAYSTAR	CUMMINS N14 DIESEL	1992-1993	VOLKSWAGEN	CRAFTER	5 CIL, 2.0 L TDI	2013-2014
KENWORTH	K100	CUMMINS N14 DIESEL	1992-1993	T1663			
KENWORTH	W900	CUMMINS N14 DIESEL	1993-1996	PEUGEOT	PARTNER MAXI	4 CIL, 1.6 L TURBO DIESEL	2012-2014
KENWORTH	W900	CUMMINS NTC 300	1990-1990	T203			
PQ28501				CHEVROLET	TORNADO	4 CIL, 1.8 L	2003-2013
DINA	S-700	CUMMINS 350	1990-1997	T260			
FREIGHTLINER	FLC	CUMMINS N14 DIESEL	1992-1996	VOLKSWAGEN	PANEL	4 CIL, 1.8 L	1993-2001
FREIGHTLINER	FLD	CUMMINS N14 DIESEL	1992-1996	VOLKSWAGEN	VW VAN	4 CIL, 1.8 L	2005-2006
KENWORTH	K100	CUMMINS N14 DIESEL	1992-1993	T276			
PQ28514				FORD	RANGER	4 CIL, 2.3 L	1996-2002
INTERNATIONAL/NAVISTAR	5000	CUMMINS N14 DIESEL	1992-1993	FORD	RANGER	4 CIL, 2.5 L	1996-2001
INTERNATIONAL/NAVISTAR	PAYSTAR	CUMMINS N14 DIESEL	1992-1993	T321			
PQ28522				VOLKSWAGEN	CRAFTER	5 CIL, 2.5 L TDI	2008-2013
INTERNATIONAL/NAVISTAR	5000	CUMMINS N14 DIESEL	1999-2000	T333			
INTERNATIONAL/NAVISTAR	5000	CUMMINS N14 DIESEL	1994-1998	VOLKSWAGEN	EUROVAN	4 CIL, 1.9 L DIESEL	2005-2005
INTERNATIONAL/NAVISTAR	PAYSTAR	CUMMINS N14 DIESEL	1999-2000	T724			
INTERNATIONAL/NAVISTAR	PAYSTAR	CUMMINS N14 DIESEL	1994-1998	HYUNDAI	H100	4 CIL, 2.5 L DIESEL	2009-2014
PQ28580				HYUNDAI	H100 VAN/WAGON	4 CIL, 2.5 L DIESEL	2009-2013
DINA	D-9400 EAGLE	DETROIT DIESEL SERIE 60, 12.7 L	1993-1994	T739			
T070							



MASTER SERVICIO PESADO 2014

BANDAS

MARCA	MODELO	MOTOR	AÑOS	MARCA	MODELO	MOTOR	AÑOS
VOLKSWAGEN	EUROVAN	5 CIL, 2.5 L	2001-2003	TR22545			
TR20619				KENWORTH	T600	CATERPILLAR 3406 DIESEL	1991-1999
FREIGHTLINER	FLC	CATERPILLAR 3406 DIESEL	1990-1993	KENWORTH	T800	CATERPILLAR 3406 DIESEL	1999-2000
TR22358				KENWORTH	T800	CATERPILLAR 3406 DIESEL	1991-1998
INTERNATIONAL/NAVISTAR	8100	CUMMINS N14 DIESEL	1995-1996	KENWORTH	T800	CATERPILLAR C15 DIESEL	2000-2004
INTERNATIONAL/NAVISTAR	8200	CUMMINS N14 DIESEL	1995-1996	KENWORTH	T800	CATERPILLAR C16 DIESEL	2000-2003
TR22461				TR22553			
CHEVROLET	C6500	ISUZU 6HK1-TC DIESEL	2003-2007	INTERNATIONAL/NAVISTAR	9300	CATERPILLAR 3406 DIESEL	1995-1995
CHEVROLET	C7500	ISUZU 6HK1-TC DIESEL	2003-2007	INTERNATIONAL/NAVISTAR	9300	CATERPILLAR 3406 DIESEL	1995-1995
CHEVROLET	C8500	ISUZU 6HK1-TC DIESEL	2003-2007	INTERNATIONAL/NAVISTAR	9400	CATERPILLAR 3406 DIESEL	1995-1995
TR22485				INTERNATIONAL/NAVISTAR	9400	CATERPILLAR 3406 DIESEL	1995-1995
INTERNATIONAL/NAVISTAR	8100	CUMMINS ISM DIESEL	1998-1998	KENWORTH	T600	CATERPILLAR C15 DIESEL	2000-2004
INTERNATIONAL/NAVISTAR	8100	CUMMINS ISM DIESEL	1999-2003	KENWORTH	W900	CATERPILLAR 3406 DIESEL	1990-1999
INTERNATIONAL/NAVISTAR	8100	CUMMINS L10 DIESEL	1995-1997	VOLVO	WIA SERIES	CATERPILLAR 3406 DIESEL	1996-1998
INTERNATIONAL/NAVISTAR	8100	CUMMINS M11 DIESEL	1995-1997	TR22570			
INTERNATIONAL/NAVISTAR	8200	CUMMINS ISM DIESEL	1998-1998	INTERNATIONAL/NAVISTAR	9300	CATERPILLAR 3406 DIESEL	1995-1995
INTERNATIONAL/NAVISTAR	8200	CUMMINS L10 DIESEL	1995-1997	INTERNATIONAL/NAVISTAR	9300	CATERPILLAR 3406 DIESEL	1995-1995
INTERNATIONAL/NAVISTAR	8200	CUMMINS M11 DIESEL	1995-1997	INTERNATIONAL/NAVISTAR	9400	CATERPILLAR 3406 DIESEL	1995-1995
INTERNATIONAL/NAVISTAR	9100I	CUMMINS ISM DIESEL	2000-2003	INTERNATIONAL/NAVISTAR	9400	CATERPILLAR 3406 DIESEL	1995-1995
INTERNATIONAL/NAVISTAR	9200	CUMMINS M11 DIESEL	1995-1998	INTERNATIONAL/NAVISTAR	9600	CUMMINS M11 DIESEL	1996-1996
INTERNATIONAL/NAVISTAR	9200I	CUMMINS ISM DIESEL	2000-2002	INTERNATIONAL/NAVISTAR	9700	CUMMINS M11 DIESEL	1996-1996
INTERNATIONAL/NAVISTAR	9300	CUMMINS M11 DIESEL	1996-1997	INTERNATIONAL/NAVISTAR	9800	CUMMINS M11 DIESEL	1997-1997
INTERNATIONAL/NAVISTAR	9400	CUMMINS M11 DIESEL	1996-1997	KENWORTH	T2000	CATERPILLAR 3406 DIESEL	1997-2000
INTERNATIONAL/NAVISTAR	9400I	CUMMINS ISM DIESEL	2000-2003	KENWORTH	T2000	CATERPILLAR C15 DIESEL	2000-2003
INTERNATIONAL/NAVISTAR	9900I	CUMMINS ISM DIESEL	2000-2003	KENWORTH	T2000	CATERPILLAR C16 DIESEL	2000-2003
INTERNATIONAL/NAVISTAR	9900IX	CUMMINS ISM DIESEL	2000-2002	KENWORTH	T600	CATERPILLAR 3406 DIESEL	1991-1996
TR22508				KENWORTH	T800	CATERPILLAR 3406 DIESEL	1991-1996
FREIGHTLINER	FLC	CUMMINS L10 DIESEL	1990-1993	KENWORTH	W900	CATERPILLAR 3406 DIESEL	1991-2000
FREIGHTLINER	FLD	CATERPILLAR 3406 DIESEL	1990-1997	KENWORTH	W900	CATERPILLAR C10 DIESEL	1997-2000
FREIGHTLINER	FLD	CUMMINS L10 DIESEL	1990-1993	KENWORTH	W900	CATERPILLAR C12 DIESEL	2000-2000
TR22517				KENWORTH	W900	CATERPILLAR C15 DIESEL	2000-2003
FREIGHTLINER	FLD	CATERPILLAR 3406 DIESEL	1990-1992	KENWORTH	W900	CATERPILLAR C16 DIESEL	2000-2003
FREIGHTLINER	FLD	CATERPILLAR 3406 DIESEL	1993-1997	TR22588			
TR22525				FREIGHTLINER	FLC	CATERPILLAR 3406 DIESEL	1990-1993
INTERNATIONAL/NAVISTAR	5000	CUMMINS ISM DIESEL	1998-1998	KENWORTH	K100	CATERPILLAR 3406 DIESEL	1991-1993
INTERNATIONAL/NAVISTAR	5000	CUMMINS M11 DIESEL	1996-1997	KENWORTH	W900	CATERPILLAR 3406 DIESEL	1990-1996
INTERNATIONAL/NAVISTAR	5000	CUMMINS M11 DIESEL	1996-1998	TR22607			
INTERNATIONAL/NAVISTAR	5000	CUMMINS M11 DIESEL	2000-2000	INTERNATIONAL/NAVISTAR	9300	CATERPILLAR 3406 DIESEL	1995-1995
INTERNATIONAL/NAVISTAR	5500I	CUMMINS ISM DIESEL	2000-2000	INTERNATIONAL/NAVISTAR	9400	CATERPILLAR 3406 DIESEL	1995-1995
INTERNATIONAL/NAVISTAR	5600I	CUMMINS ISM DIESEL	2000-2000	KENWORTH	K100	CATERPILLAR 3406 DIESEL	1990-1991
INTERNATIONAL/NAVISTAR	5900I	CUMMINS ISM DIESEL	2000-2000	TR22625			
INTERNATIONAL/NAVISTAR	PAYSTAR	CUMMINS M11 DIESEL	1996-1998	FREIGHTLINER	FLC	CATERPILLAR 3406 DIESEL	1990-1993
INTERNATIONAL/NAVISTAR	PAYSTAR	CUMMINS M11 DIESEL	2000-2000	KENWORTH	T600	CATERPILLAR 3406 DIESEL	1990-1996
TR22534				KENWORTH	T800	CATERPILLAR 3406 DIESEL	1990-1996
FREIGHTLINER	FLD	CATERPILLAR 3406 DIESEL	1990-1997	TR22635			



MASTER SERVICIO PESADO 2014

BANDAS















MARCA	MODELO	MOTOR	AÑOS	MARCA	MODELO	MOTOR	AÑOS
KENWORTH	C500	CATERPILLAR C15 DIESEL	2000-2003				
KENWORTH	C500	CATERPILLAR C16 DIESEL	2000-2000				
TR22648							
FREIGHTLINER	FLC	CATERPILLAR 3406 DIESEL	1990-1993				
KENWORTH	W900	CATERPILLAR 3406 DIESEL	1990-1990				
KENWORTH	W900	CATERPILLAR 3406 DIESEL	1991-1996				
KENWORTH	W900	CATERPILLAR C15 DIESEL	2004-2004				
TR22676							
INTERNATIONAL/NAVISTAR	9300	CATERPILLAR 3406 DIESEL	1995-1995				
INTERNATIONAL/NAVISTAR	9300	CATERPILLAR 3406 DIESEL	1995-1995				
INTERNATIONAL/NAVISTAR	9400	CATERPILLAR 3406 DIESEL	1995-1995				
INTERNATIONAL/NAVISTAR	9400	CATERPILLAR 3406 DIESEL	1995-1995				
TR22770							
DINA	S-400	INTERNATIONAL/NAVISTAR DT360 DIESEL	1990-1997				
DINA	S-500	INTERNATIONAL/NAVISTAR DT360 DIESEL	1990-1997				
DINA	S-500	INTERNATIONAL/NAVISTAR DT466 DIESEL	1990-1997				
TR24438							
KENWORTH	K100	CUMMINS 6 CIL, 14.0 L DIESEL	1991-1991				
KENWORTH	K100	CUMMINS N14 DIESEL	1992-1993				
TR24457							
KENWORTH	K100	CUMMINS 6 CIL, 14.0 L DIESEL	1991-1991				
KENWORTH	K100	CUMMINS N14 DIESEL	1992-1993				
TR24530							
INTERNATIONAL/NAVISTAR	5000	CUMMINS N14 DIESEL	1992-1993				
INTERNATIONAL/NAVISTAR	PAYSTAR	CUMMINS N14 DIESEL	1992-1993				
TR28390							
VOLVO	WG SERIES	CUMMINS N14 DIESEL	1996-1996				
VOLVO	WIA SERIES	CUMMINS N14 DIESEL	1996-1998				
TR28400							
KENWORTH	K100	CUMMINS 6 CIL, 14.0 L DIESEL	1991-1991				
KENWORTH	K100	CUMMINS N14 DIESEL	1992-1993				
KENWORTH	T600	CUMMINS 6 CIL, 14.0 L DIESEL	1991-1991				
KENWORTH	T600	CUMMINS N14 DIESEL	1992-1996				
KENWORTH	T800	CUMMINS 6 CIL, 14.0 L DIESEL	1991-1991				
KENWORTH	T800	CUMMINS N14 DIESEL	1992-1996				
VOLVO	WIA SERIES	CUMMINS N14 DIESEL	1996-1997				
TR28412							
FREIGHTLINER	CENTURY CLASS	CUMMINS N14 DIESEL	1996-2001				
FREIGHTLINER	CENTURY CLASS	CUMMINS N14 DIESEL	1998-1998				
FREIGHTLINER	FLC	CUMMINS N14 DIESEL	1997-1998				
KENWORTH	T2000	CUMMINS N14 DIESEL	1997-2000				
KENWORTH	T600	CUMMINS 6 CIL, 14.0 L DIESEL	1991-1991				
KENWORTH	T600	CUMMINS N14 DIESEL	1992-1996				
KENWORTH	T800	CUMMINS 6 CIL, 14.0 L DIESEL	1991-1991				
KENWORTH	T800	CUMMINS N14 DIESEL	1992-1996				
TR28429							
FREIGHTLINER	CENTURY CLASS	CUMMINS N14 DIESEL	1997-1997				
FREIGHTLINER	CLASSIC	CUMMINS N14 DIESEL	2001-2001				
FREIGHTLINER	CLASSIC XL	CUMMINS N14 DIESEL	2001-2001				
FREIGHTLINER	FLC	CUMMINS N14 DIESEL	1991-1992				
FREIGHTLINER	FLC	CUMMINS N14 DIESEL	1993-1996				
FREIGHTLINER	FLD	CUMMINS N14 DIESEL	1997-2001				
FREIGHTLINER	FLD	CUMMINS N14 DIESEL	1991-1992				
FREIGHTLINER	FLD	CUMMINS N14 DIESEL	1993-1996				
KENWORTH	T600	CUMMINS 6 CIL, 14.0 L DIESEL	1991-1991				
KENWORTH	T600	CUMMINS N14 DIESEL	1996-1996				
KENWORTH	T800	CUMMINS N14 DIESEL	1992-1996				
KENWORTH	T800	CUMMINS 6 CIL, 14.0 L DIESEL	1991-1991				
KENWORTH	T800	CUMMINS N14 DIESEL	1992-1996				
TR28437							
FREIGHTLINER	FLC	CUMMINS N14 DIESEL	1991-1992				
FREIGHTLINER	FLC	CUMMINS N14 DIESEL	1993-1996				
FREIGHTLINER	FLD	CUMMINS N14 DIESEL	1991-1992				
FREIGHTLINER	FLD	CUMMINS N14 DIESEL	1993-1996				
KENWORTH	T600	CATERPILLAR 3406 DIESEL	1991-1996				
KENWORTH	T600	CUMMINS 6 CIL, 14.0 L DIESEL	1991-1991				
KENWORTH	T600	CUMMINS N14 DIESEL	1997-2001				
KENWORTH	T600	CUMMINS N14 DIESEL	1992-1996				
KENWORTH	T800	CATERPILLAR 3406 DIESEL	1991-1996				
KENWORTH	T800	CUMMINS 6 CIL, 14.0 L DIESEL	1991-1991				
KENWORTH	T800	CUMMINS N14 DIESEL	1998-2002				
KENWORTH	T800	CUMMINS N14 DIESEL	1992-1996				
TR28445							
FREIGHTLINER	COLUMBIA	CUMMINS N14 DIESEL	2003-2003				
FREIGHTLINER	FLC	CUMMINS N14 DIESEL	1991-1996				
FREIGHTLINER	FLD	CUMMINS N14 DIESEL	1991-1996				
TR28463							
KENWORTH	T800	CUMMINS N14 DIESEL	2002-2003				
TR28473							
FREIGHTLINER	FLC	CUMMINS N14 DIESEL	1991-1992				
FREIGHTLINER	FLC	CUMMINS N14 DIESEL	1993-1996				
FREIGHTLINER	FLD	CUMMINS N14 DIESEL	1991-1992				
FREIGHTLINER	FLD	CUMMINS N14 DIESEL	1993-1996				
INTERNATIONAL/NAVISTAR	8100	CUMMINS N14 DIESEL	1995-1999				
INTERNATIONAL/NAVISTAR	8200	CUMMINS N14 DIESEL	1995-1998				
INTERNATIONAL/NAVISTAR	9200	CUMMINS N14 DIESEL	1996-1996				
KENWORTH	W900	CUMMINS N14 DIESEL	2003-2003				
TR28480							
FREIGHTLINER	FLC	CUMMINS N14 DIESEL	1991-1992				
FREIGHTLINER	FLC	CUMMINS N14 DIESEL	1993-1996				



MASTER SERVICIO PESADO 2014

BANDAS

MARCA	MODELO	MOTOR	AÑOS	MARCA	MODELO	MOTOR	AÑOS
FREIGHTLINER	FLD	CUMMINS N14 DIESEL	1991-1992	INTERNATIONAL/NAVISTAR	9700	CUMMINS N14 DIESEL	1996-1996
FREIGHTLINER	FLD	CUMMINS N14 DIESEL	1993-1996	INTERNATIONAL/NAVISTAR	9800	CUMMINS N14 DIESEL	1997-1999
INTERNATIONAL/NAVISTAR	8100	CUMMINS N14 DIESEL	1995-1995	TR28522			
INTERNATIONAL/NAVISTAR	8200	CUMMINS N14 DIESEL	1995-1995	INTERNATIONAL/NAVISTAR	5000	CUMMINS N14 DIESEL	1999-1999
INTERNATIONAL/NAVISTAR	9200	CUMMINS N14 DIESEL	1996-1996	INTERNATIONAL/NAVISTAR	5000	CUMMINS N14 DIESEL	1995-1998
INTERNATIONAL/NAVISTAR	9300	CUMMINS N14 DIESEL	1995-1995	INTERNATIONAL/NAVISTAR	5500I	CUMMINS N14 DIESEL	2000-2003
INTERNATIONAL/NAVISTAR	9400	CUMMINS N14 DIESEL	1995-1995	INTERNATIONAL/NAVISTAR	5600I	CUMMINS N14 DIESEL	2000-2003
KENWORTH	W900	CUMMINS N14 DIESEL	1993-1996	INTERNATIONAL/NAVISTAR	5900I	CUMMINS N14 DIESEL	2000-2003
TR28483				INTERNATIONAL/NAVISTAR	8100	CUMMINS N14 DIESEL	1998-1999
KENWORTH	T800	CUMMINS N14 DIESEL	1997-1997	INTERNATIONAL/NAVISTAR	8100	CUMMINS N14 DIESEL	1996-1996
KENWORTH	W900	CUMMINS N14 DIESEL	1997-2002	INTERNATIONAL/NAVISTAR	8100	CUMMINS N14 DIESEL	1996-1996
TR28492				INTERNATIONAL/NAVISTAR	8100	CUMMINS N14 DIESEL	1995-1996
FREIGHTLINER	FLC	CUMMINS N14 DIESEL	1991-1992	INTERNATIONAL/NAVISTAR	8100	CUMMINS N14 DIESEL	1996-1996
FREIGHTLINER	FLC	CUMMINS N14 DIESEL	1993-1996	INTERNATIONAL/NAVISTAR	8200	CUMMINS N14 DIESEL	1996-1996
FREIGHTLINER	FLD	CUMMINS N14 DIESEL	1991-1992	INTERNATIONAL/NAVISTAR	8200	CUMMINS N14 DIESEL	1996-1996
FREIGHTLINER	FLD	CUMMINS N14 DIESEL	1993-1996	INTERNATIONAL/NAVISTAR	8200	CUMMINS N14 DIESEL	1995-1996
INTERNATIONAL/NAVISTAR	9200	CUMMINS N14 DIESEL	1996-1996	INTERNATIONAL/NAVISTAR	8200	CUMMINS N14 DIESEL	1996-1996
INTERNATIONAL/NAVISTAR	9600	CUMMINS N14 DIESEL	1996-1996	INTERNATIONAL/NAVISTAR	9200	CUMMINS N14 DIESEL	1996-1996
INTERNATIONAL/NAVISTAR	9700	CUMMINS N14 DIESEL	1996-1996	TR28545			
INTERNATIONAL/NAVISTAR	9800	CUMMINS N14 DIESEL	1997-1999	INTERNATIONAL/NAVISTAR	8100	CUMMINS N14 DIESEL	1995-1995
KENWORTH	K100	CUMMINS 6 CIL. 14.0 L DIESEL	1991-1991	INTERNATIONAL/NAVISTAR	8200	CUMMINS N14 DIESEL	1995-1995
KENWORTH	K100	CUMMINS N14 DIESEL	1992-1993	TR28550			
KENWORTH	W900	CUMMINS N14 DIESEL	1993-1996	INTERNATIONAL/NAVISTAR	9200	CUMMINS N14 DIESEL	1996-1996
TR28498				INTERNATIONAL/NAVISTAR	9300	CUMMINS N14 DIESEL	1995-1995
INTERNATIONAL/NAVISTAR	9600	CUMMINS N14 DIESEL	1996-1996	INTERNATIONAL/NAVISTAR	9400	CUMMINS N14 DIESEL	1995-1995
INTERNATIONAL/NAVISTAR	9700	CUMMINS N14 DIESEL	1996-1996	INTERNATIONAL/NAVISTAR	9800	CUMMINS N14 DIESEL	1997-1999
TR28501				TR28565			
FREIGHTLINER	FLC	CUMMINS N14 DIESEL	1991-1996	INTERNATIONAL/NAVISTAR	9200	CUMMINS N14 DIESEL	1996-1996
FREIGHTLINER	FLD	CUMMINS N14 DIESEL	1991-1996	INTERNATIONAL/NAVISTAR	9800	CUMMINS N14 DIESEL	1997-1999
INTERNATIONAL/NAVISTAR	8100	CUMMINS N14 DIESEL	1996-1996	TR28510			
INTERNATIONAL/NAVISTAR	8200	CUMMINS N14 DIESEL	1996-1996	INTERNATIONAL/NAVISTAR	8100	CUMMINS N14 DIESEL	1996-1996
INTERNATIONAL/NAVISTAR	9200	CUMMINS N14 DIESEL	1996-1996	INTERNATIONAL/NAVISTAR	8200	CUMMINS N14 DIESEL	1996-1996
INTERNATIONAL/NAVISTAR	9300	CUMMINS N14 DIESEL	1995-1995	INTERNATIONAL/NAVISTAR	9200	CUMMINS N14 DIESEL	1996-1996
INTERNATIONAL/NAVISTAR	9400	CUMMINS N14 DIESEL	1995-1996	INTERNATIONAL/NAVISTAR	9300	CUMMINS N14 DIESEL	1995-1995
TR28514				INTERNATIONAL/NAVISTAR	9400	CUMMINS N14 DIESEL	1995-1996
INTERNATIONAL/NAVISTAR	8100	CUMMINS N14 DIESEL	1995-1996	INTERNATIONAL/NAVISTAR	9600	CUMMINS N14 DIESEL	1996-1996
INTERNATIONAL/NAVISTAR	8200	CUMMINS N14 DIESEL	1995-1996	TR28510			
INTERNATIONAL/NAVISTAR	9300	CUMMINS N14 DIESEL	1995-1995	INTERNATIONAL/NAVISTAR	8100	CUMMINS N14 DIESEL	1996-1996
INTERNATIONAL/NAVISTAR	9400	CUMMINS N14 DIESEL	1995-1996	INTERNATIONAL/NAVISTAR	8200	CUMMINS N14 DIESEL	1996-1996
INTERNATIONAL/NAVISTAR	9600	CUMMINS N14 DIESEL	1996-1996	INTERNATIONAL/NAVISTAR	9200	CUMMINS N14 DIESEL	1996-1996

MARCA	MODELO	MOTOR	AÑOS	MARCA	MODELO	MOTOR	AÑOS
		CH-227182 MANGUERA INFERIOR				CH-220112 MANGUERA INFERIOR	
VOLKSWAGEN	PANEL	4 CIL, 1.8 L	1993-2001	VOLKSWAGEN	EUROVAN	4 CIL. 1.9 L DIESEL	2005-2010
		CH-227181 MANGUERA SUPERIOR				CH-220111 MANGUERA SUPERIOR	
VOLKSWAGEN	PANEL	4 CIL, 1.8 L	1993-2001	VOLKSWAGEN	EUROVAN	4 CIL. 1.9 L DIESEL	2005-2010
		CH-220772 MANGUERA SUPERIOR				CH-181222 MANGUERA INFERIOR	
VOLKSWAGEN	EUROVAN	4 CIL. 1.9 L DIESEL	2006-2006	NISSAN	ESTAQUITAS	4 CIL, 1.8 L	1993-1994
VOLKSWAGEN	EUROVAN	5 CIL, 2.5 L	2001-2002				
VOLKSWAGEN	EUROVAN	5 CIL, 2.5 L	2005-2005				
VOLKSWAGEN	EUROVAN	5 CIL, 2.5 L	2006-2006				
		CH-220762 MANGUERA SUPERIOR				CH-181001 MANGUERA SUPERIOR	
VOLKSWAGEN	EUROVAN	4 CIL. 1.9 L DIESEL	2006-2006	NISSAN	ESTAQUITAS	4 CIL, 1.8 L	1993-1994
VOLKSWAGEN	EUROVAN	5 CIL, 2.5 L	2001-2002				
VOLKSWAGEN	EUROVAN	5 CIL, 2.5 L	2003-2003				
VOLKSWAGEN	EUROVAN	5 CIL, 2.5 L	2005-2005				
VOLKSWAGEN	EUROVAN	5 CIL, 2.5 L	2006-2006				
		CH-220751 MANGUERA SUPERIOR				CH-180302 MANGUERA INFERIOR	
VOLKSWAGEN	EUROVAN	5 CIL, 2.5 L	2001-2002	NISSAN	NP300	4 CIL. 2.5 L DIESEL	2008-2012
VOLKSWAGEN	EUROVAN	5 CIL, 2.5 L	2003-2003				
		CH-220741 MANGUERA SUPERIOR				CH-180301 MANGUERA SUPERIOR	
VOLKSWAGEN	EUROVAN	5 CIL, 2.5 L	2001-2002	NISSAN	NP300	4 CIL. 2.5 L DIESEL	2008-2012
VOLKSWAGEN	EUROVAN	5 CIL, 2.5 L	2003-2003				
		CH-220593 MANGUERA DE PASO				CH-180202 MANGUERA INFERIOR	
VOLKSWAGEN	PANEL	4 CIL, 1.8 L	1993-2001	NISSAN	ESTAQUITAS	4 CIL, 2.4 L	1995-2009
				NISSAN	PICK-UP	4 CIL, 2.4 L	1994-2007
						CH-180191 MANGUERA SUPERIOR	
				RENAULT	KANGOO	4 CIL, 1.6 L	2005-2013
				RENAULT	KANGOO EXPRESS	4 CIL, 1.6 L	2005-2008



























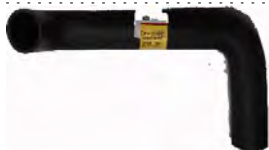

MASTER SERVICIO PESADO 2014

MANGUERAS

MARCA	MODELO	MOTOR	AÑOS	MARCA	MODELO	MOTOR	AÑOS
		CH-180182 MANGUERA INFERIOR				CH-180101 MANGUERA SUPERIOR	
RENAULT	KANGOO	4 CIL, 1.6 L	2005-2013	NISSAN	NP300	4 CIL, 2.4 L	2008-2012
RENAULT	KANGOO EXPRESS	4 CIL, 1.6 L	2005-2008				
		CH-180172 MANGUERA INFERIOR				CH-180042 MANGUERA INFERIOR	
NISSAN	URVAN	4 CIL, 3.0 L DIESEL	2009-2013	NISSAN	CHASIS	4 CIL, 2.4 L	1998-2006
				NISSAN	ESTAQUITAS	4 CIL, 2.4 L	1998-2001
		CH-180171 MANGUERA SUPERIOR				CH-180041 MANGUERA SUPERIOR	
NISSAN	URVAN	4 CIL, 3.0 L DIESEL	2009-2013	NISSAN	PICK-UP	4 CIL, 2.4 L	1993-1994
		CH-180152 MANGUERA INFERIOR				CH-180031 MANGUERA SUPERIOR	
NISSAN	URVAN	4 CIL, 2.4 L	2000-2008	NISSAN	CHASIS	4 CIL, 2.4 L	1998-2006
				NISSAN	ESTAQUITAS	4 CIL, 2.4 L	1998-2001
		CH-180151 MANGUERA SUPERIOR				CH-170005 MANGUERA INFERIOR	
NISSAN	URVAN	4 CIL, 2.5 L	2009-2013	MERCEDES BENZ	1114	OM 366	1990-1994
				MERCEDES BENZ	1314	OM 366	1990-1994
		CH-180142 MANGUERA INFERIOR		MERCEDES BENZ	1317	OM 366	1990-1994
NISSAN	URVAN	4 CIL, 2.5 L	2009-2013	MERCEDES BENZ	1417	OM 366	1990-1994
				MERCEDES BENZ	1517	OM 366	1990-1994
		CH-180141 MANGUERA INFERIOR		MERCEDES BENZ	1521	OM 366	1990-1994
NISSAN	URVAN	4 CIL, 2.4 L	2005-2005	MERCEDES BENZ	2121	OM 366	1990-1994
NISSAN	URVAN	4 CIL, 2.4 L	2000-2008				
		CH-180102 MANGUERA INFERIOR				CH-170001 MANGUERA SUPERIOR	
NISSAN	NP300	4 CIL, 2.4 L	2008-2012	MERCEDES BENZ	0371 RS	OM 355	1990-1998
				MERCEDES BENZ	0371 RS	OM 447	1990-1998
				MERCEDES BENZ	1114	OM 366	1990-1994
				MERCEDES BENZ	1314	OM 366	1990-1994
				MERCEDES BENZ	1317	OM 366	1990-1994
				MERCEDES BENZ	1417	OM 366	1990-1994
				MERCEDES BENZ	1517	OM 366	1990-1994
				MERCEDES BENZ	1521	OM 366	1990-1994

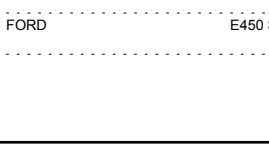

MARCA	MODELO	MOTOR	AÑOS	MARCA	MODELO	MOTOR	AÑOS
MERCEDES BENZ	2121	OM 366	1990-1994				
						CH-150112 MANGUERA INFERIOR	
TOYOTA	HIACE	4 CIL. 2.7 L	2006-2012				
TOYOTA	HIACE	4 CIL. 2.7 L	2006-2013			CH-140201 MANGUERA SUPERIOR	
				CHEVROLET	TORNADO	4 CIL, 1.8 L	2003-2013
							
						CH-130292 MANGUERA INFERIOR	
				FORD	COURIER	4 CIL, 1.6 L	2003-2012
							
						CH-150102 MANGUERA INFERIOR	
TOYOTA	HIACE	4 CIL. 2.7 L	2006-2012				
TOYOTA	HIACE	4 CIL. 2.7 L	2006-2013			CH-130281 MANGUERA SUPERIOR	
				FORD	COURIER	4 CIL, 1.6 L	2003-2012
							
						CH-150101 MANGUERA SUPERIOR	
TOYOTA	HIACE	4 CIL. 2.7 L	2006-2013				
						CH-130122 MANGUERA INFERIOR	
				FORD	TRANSIT	4 CIL, 2.2 L TDI	2008-2013
							
						CH-147162 MANGUERA INFERIOR	
CHEVROLET	S-10	V6, 3.1 L	1991-1994				
CHEVROLET	S-10	V6, 4.3 L	1994-1994			CH-124832 MANGUERA INFERIOR	
				DINA	S-600	CUMMINS 8.3 L DIESEL	1990-1997
							
						CH-147151 MANGUERA SUPERIOR	
CHEVROLET	S-10	V6, 3.1 L	1991-1994				
CHEVROLET	S-10	V6, 4.3 L	1994-1994			CH-124831 MANGUERA SUPERIOR	
				DINA	S-600	CUMMINS 8.3 L DIESEL	1990-1997
							
						CH-140242 MANGUERA INFERIOR	
CHEVROLET	LUV	4 CIL, 2.2 L	2001-2003				
						CH-124762 MANGUERA INFERIOR	
				DINA	S-600	INTERNATIONAL/NAVISTAR DT466	1990-1997
							
						CH-140231 MANGUERA SUPERIOR	
CHEVROLET	LUV	4 CIL, 2.2 L	2001-2003				
						CH-124761 MANGUERA SUPERIOR	
				DINA	S-600	INTERNATIONAL/NAVISTAR DT466	1990-1997
							
						CH-140222 MANGUERA INFERIOR	
CHEVROLET	TORNADO	4 CIL, 1.8 L	2003-2013				
						CH-123212 MANGUERA INFERIOR	
				DINA	CITUS	INTERNATIONAL/NAVISTAR DT466	1992-1998

MARCA	MODELO	MOTOR	AÑOS	MARCA	MODELO	MOTOR	AÑOS
		CH-122011 MANGUERA SUPERIOR		DODGE	RAM-4000	V6, 5.9 L DIESEL	1998-2001
DINA	S-400	PERKINS 5.8 L DIESEL	1990-1997	DODGE	RAM-4000	V6, 5.9 L DIESEL	1995-1997
DINA	S-500 CORAZA	PERKINS 5.8 L DIESEL	1990-1997			CH-114602 MANGUERA INFERIOR	
DINA	S-500 CORAZA	PERKINS T6-354.4	1990-1996	DODGE	D-600	DODGE V8, 6.0 L	1992-1993
		CH-121042 MANGUERA INFERIOR				CH-114601 MANGUERA SUPERIOR	
DINA	S-400	INTERNATIONAL/NAVISTAR DT360 DIESEL	1990-1997	DODGE	D-600	DODGE V8, 6.0 L	1992-1993
DINA	S-500	INTERNATIONAL/NAVISTAR DT360 DIESEL	1990-1997			CH-114592 MANGUERA INFERIOR	
		CH-120692 MANGUERA INFERIOR		DODGE	D-600	DODGE V8, 5.9 L	1993-1994
DINA	S-400	PERKINS 5.8 L DIESEL	1990-1997			CH-114591 MANGUERA SUPERIOR	
DINA	S-500 CORAZA	PERKINS 5.8 L DIESEL	1990-1997	DODGE	D-600	DODGE V8, 5.9 L	1993-1994
DINA	S-500 CORAZA	PERKINS T6-354.4	1990-1992			CH-112592 MANGUERA INFERIOR	
		CH-120192 MANGUERA INFERIOR		DODGE	RAM-6500	V8, 5.9 L	1994-1997
DINA	URBANO	CATERPILLAR 3126 DIESEL	1996-2000			CH-112591 MANGUERA SUPERIOR	
		CH-119412 MANGUERA INFERIOR		DODGE	RAM-6500	V8, 5.9 L	1994-1997
HYUNDAI	H100	4 CIL, 2.5 L DIESEL	2009-2014			28469 MANGUERA DE ENFRIAMIENTO	
		CH-119411 MANGUERA SUPERIOR		DODGE	RAM-6500	V8, 5.9 L	1994-1997
HYUNDAI	H100	4 CIL, 2.5 L DIESEL	2009-2014			28467 MANGUERA DE CALEFACCIÓN	
		CH-117592 MANGUERA INFERIOR		CHEVROLET	S-10	4 CIL, 2.2 L	2002-2002
DODGE	RAM-4000	V6, 5.9 L DIESEL	1995-1997			CH-115591 MANGUERA MOLDEADA	
DODGE	RAM-4000	V6, 5.9 L DIESEL	1998-2001	FORD	E450 SUPER DUTY	FORD V8, 7.3 L DIESEL	1998-1998
		CH-115591 MANGUERA MOLDEADA		FORD	E450 SUPER DUTY	FORD V8, 7.3 L DIESEL	1998-1998
				FORD	E450 SUPER DUTY	FORD V8, 7.3 L DIESEL	1998-1998

















MASTER SERVICIO PESADO 2014

MANGUERAS

MARCA	MODELO	MOTOR	AÑOS	MARCA	MODELO	MOTOR	AÑOS
		28466 MANGUERA DE CALEFACCIÓN		INTERNATIONAL/NAVISTAR	DURASTAR 4300	INTERNATIONAL/NAVISTAR MAXXFORCE 7 DIESEL	2010-2012
CHEVROLET	S-10	4 CIL, 2.2 L	2002-2003			23794 MANGUERA SUPERIOR	
				INTERNATIONAL/NAVISTAR	CE	INTERNATIONAL/NAVISTAR MAXXFORCE DT DIESEL	2009-2012
		28212 MANGUERA SUPERIOR		INTERNATIONAL/NAVISTAR	DURASTAR 4300	INTERNATIONAL/NAVISTAR MAXXFORCE DT DIESEL	2008-2013
KENWORTH	T660	CATERPILLAR C13 DIESEL	2009-2013	INTERNATIONAL/NAVISTAR	DURASTAR 4400	INTERNATIONAL/NAVISTAR MAXXFORCE DT DIESEL	2008-2013
		23956 MANGUERA INFERIOR				23793 MANGUERA INFERIOR	
DODGE	RAM-4000	V6, 6.7 L DIESEL	2012-2013	INTERNATIONAL/NAVISTAR	BE	INTERNATIONAL/NAVISTAR MAXXFORCE 7 DIESEL	2009-2013
		23955 MANGUERA SUPERIOR		INTERNATIONAL/NAVISTAR	DURASTAR 4300	INTERNATIONAL/NAVISTAR MAXXFORCE 7 DIESEL	2010-2012
DODGE	RAM-4000	V6, 6.7 L DIESEL	2012-2013			23572 MANGUERA INFERIOR	
		23818 MANGUERA INFERIOR		FREIGHTLINER	FLC	CUMMINS L10 DIESEL	1991-1993
FORD	F-450 SUPER DUTY	V8, 6.4 L DIESEL	2008-2008	FREIGHTLINER	FLC	CUMMINS L10 DIESEL	1990-1993
		23817 MANGUERA INFERIOR		FREIGHTLINER	FLD	CUMMINS L10 DIESEL	1991-1993
FORD	F-450 SUPER DUTY	V8, 6.4 L DIESEL	2008-2008	FREIGHTLINER	FLD	CUMMINS L10 DIESEL	1990-1993
		23816 MANGUERA INFERIOR				23564 MANGUERA SUPERIOR	
FORD	F-450 SUPER DUTY	V8, 6.4 L DIESEL	2008-2008	VOLVO	VNL	VOLVO D13 DIESEL	2008-2014
		23815 MANGUERA SUPERIOR		VOLVO	VNM	VOLVO D13 DIESEL	2008-2014
FORD	F-450 SUPER DUTY	V8, 6.4 L DIESEL	2008-2008			23563 MANGUERA INFERIOR	
		23795 MANGUERA SUPERIOR		MACK	CXU SERIES	MACK MP8 DIESEL	2008-2010
INTERNATIONAL/NAVISTAR	BE	INTERNATIONAL/NAVISTAR MAXXFORCE 7 DIESEL	2009-2013	VOLVO	VNL	VOLVO D13 DIESEL	2008-2014
				VOLVO	VNM	VOLVO D13 DIESEL	2008-2014
		23562 MANGUERA INFERIOR				23562 MANGUERA INFERIOR	
FREIGHTLINER	FLC	CATERPILLAR 3306 DIESEL	1992-1992	FREIGHTLINER	FLC	CATERPILLAR 3306 DIESEL	1991-1991
FREIGHTLINER	FLC	CATERPILLAR 3306 DIESEL	1991-1991	FREIGHTLINER	FLC	CATERPILLAR 3306 DIESEL	1991-1992
FREIGHTLINER	FLC	CATERPILLAR 3306 DIESEL	1991-1992	FREIGHTLINER	FLC	CATERPILLAR 3306 DIESEL	1991-1992
FREIGHTLINER	FLC	CATERPILLAR 3306 DIESEL	1991-1992	FREIGHTLINER	FLC	CATERPILLAR 3406 DIESEL	1991-1993
FREIGHTLINER	FLC	CATERPILLAR 3406 DIESEL	1991-1993	FREIGHTLINER	FLC	CATERPILLAR 3406 DIESEL	1990-1990

MARCA	MODELO	MOTOR	AÑOS	MARCA	MODELO	MOTOR	AÑOS
FREIGHTLINER	FLD	CATERPILLAR 3306 DIESEL	1992-1992			23171 MANGUERA INFERIOR	
FREIGHTLINER	FLD	CATERPILLAR 3306 DIESEL	1991-1991				
FREIGHTLINER	FLD	CATERPILLAR 3306 DIESEL	1991-1992				
FREIGHTLINER	FLD	CATERPILLAR 3306 DIESEL	1991-1992				
				FREIGHTLINER	BUSINESS CLASS M2	MERCEDES-BENZ MBE 4000 DIESEL	2005-2007
		23275 MANGUERA MOLDEADA		FREIGHTLINER	COLUMBIA	MERCEDES-BENZ MBE 4000 DIESEL	2006-2007
FORD	F-450 SUPER DUTY	V10, 6.8 L	2007-2007			23170 MANGUERA SUPERIOR	
				FREIGHTLINER	BUSINESS CLASS M2	CUMMINS ISC DIESEL	2006-2006
		23273 MANGUERA SUPERIOR				23099 MANGUERA SUPERIOR	
FORD	F-350 SUPER DUTY	V8, 5.4 L	2007-2007				
FORD	F-350 SUPER DUTY	V8, 5.4 L	2008-2009	CHEVROLET	C6500	CATERPILLAR C7 DIESEL	2004-2005
				CHEVROLET	C7500	CATERPILLAR C7 DIESEL	2004-2005
		23266 MANGUERA MOLDEADA		CHEVROLET	C8500	CATERPILLAR C7 DIESEL	2004-2005
FORD	F-450 SUPER DUTY	V10, 6.8 L	2007-2007			23096 MANGUERA SUPERIOR	
				ISUZU	ELF 400	4HK1-TC	2006-2013
		23229 MANGUERA SUPERIOR		ISUZU	ELF 450	4HK1-TC	2006-2007
FREIGHTLINER	CLASSIC	CATERPILLAR C15 DIESEL	2006-2006	ISUZU	ELF 450	4HK1-TC	2008-2008
FREIGHTLINER	CLASSIC XL	CATERPILLAR C15 DIESEL	2006-2006	ISUZU	ELF 500	4HK1-TC	2009-2013
FREIGHTLINER	FLD	CATERPILLAR C15 DIESEL	2007-2008	ISUZU	ELF 600	4HK1-TC	2009-2013
				ISUZU	ELF 600-BUS	4HK1-TC	2011-2013
		23176 MANGUERA INFERIOR				23095 MANGUERA INFERIOR	
INTERNATIONAL/NAVISTAR	CE	INTERNATIONAL/NAVISTAR DT466	2006-2006	ISUZU	ELF 400	4HK1-TC	2006-2013
				ISUZU	ELF 450	4HK1-TC	2008-2008
		23175 MANGUERA INFERIOR		ISUZU	ELF 500	4HK1-TC	2009-2013
INTERNATIONAL/NAVISTAR	CE	INTERNATIONAL/NAVISTAR DT466	2006-2006	ISUZU	ELF 600	4HK1-TC	2009-2013
				ISUZU	ELF 600-BUS	4HK1-TC	2011-2013
		23173 MANGUERA INFERIOR				23088 MANGUERA INFERIOR	
FREIGHTLINER	BUSINESS CLASS M2	CATERPILLAR C9 DIESEL	2004-2007	CHEVROLET	C6500	CATERPILLAR C7 DIESEL	2004-2006
				CHEVROLET	C7500	CATERPILLAR C7 DIESEL	2004-2006
				CHEVROLET	C8500	CATERPILLAR C7 DIESEL	2004-2006

MARCA	MODELO	MOTOR	AÑOS	MARCA	MODELO	MOTOR	AÑOS
		23087 MANGUERA SUPERIOR		FREIGHTLINER	BUSINESS CLASS M2	MERCEDES-BENZ MBE 4000 DIESEL	2004-2004
CHEVROLET	C6500	CATERPILLAR C7 DIESEL	2004-2006	STERLING	A-LINE	MERCEDES-BENZ MBE 4000 DIESEL	2006-2006
CHEVROLET	C7500	CATERPILLAR C7 DIESEL	2004-2006	STERLING	L-LINE	MERCEDES-BENZ MBE 4000 DIESEL	2006-2006
CHEVROLET	C8500	CATERPILLAR C7 DIESEL	2004-2006			23013 MANGUERA SUPERIOR	
		23086 MANGUERA SUPERIOR		FREIGHTLINER	BUSINESS CLASS M2	MERCEDES-BENZ MBE 4000 DIESEL	2004-2004
FREIGHTLINER	BUSINESS CLASS M2	CATERPILLAR C13 DIESEL	2004-2007	FREIGHTLINER	COLUMBIA	MERCEDES-BENZ MBE 4000 DIESEL	2005-2005
FREIGHTLINER	COLUMBIA	CATERPILLAR C11 DIESEL	2006-2007			22980 MANGUERA SUPERIOR	
FREIGHTLINER	COLUMBIA	CATERPILLAR C13 DIESEL	2006-2006	STERLING	ACTERRA	CATERPILLAR C13 DIESEL	2004-2006
		23085 MANGUERA SUPERIOR		STERLING	A-LINE	CATERPILLAR C11 DIESEL	2004-2006
FREIGHTLINER	BUSINESS CLASS M2	CATERPILLAR C9 DIESEL	2004-2007	STERLING	A-LINE	CATERPILLAR C13 DIESEL	2004-2006
		23084 MANGUERA INFERIOR		STERLING	A-LINE	CATERPILLAR C15 DIESEL	2005-2006
FREIGHTLINER	CORONADO	CATERPILLAR C15 DIESEL	2005-2006	STERLING	L-LINE	CATERPILLAR C11 DIESEL	2004-2007
		23077 MANGUERA SUPERIOR		STERLING	L-LINE	CATERPILLAR C13 DIESEL	2004-2007
FORD	E450 SUPER DUTY	FORD V8, 6.0 L DIESEL	2005-2006	STERLING	L-LINE	CATERPILLAR C15 DIESEL	2007-2007
		23076 MANGUERA INFERIOR		STERLING	L-LINE	CATERPILLAR C15 DIESEL	2005-2007
FORD	E450 SUPER DUTY	FORD V8, 6.0 L DIESEL	2005-2006	STERLING	L-LINE	CATERPILLAR C9 DIESEL	2005-2007
		23015 MANGUERA INFERIOR				22959 MANGUERA SUPERIOR	
FREIGHTLINER	CLASSIC	CATERPILLAR C15 DIESEL	2004-2006	FREIGHTLINER	BUSINESS CLASS M2	MERCEDES-BENZ MBE 4000 DIESEL	2005-2007
FREIGHTLINER	CLASSIC XL	CATERPILLAR C15 DIESEL	2006-2006	FREIGHTLINER	COLUMBIA	MERCEDES-BENZ MBE 4000 DIESEL	2005-2007
FREIGHTLINER	FLD	CATERPILLAR C15 DIESEL	2007-2008			22952 MANGUERA INFERIOR	
		23014 MANGUERA INFERIOR		FREIGHTLINER	BUSINESS CLASS M2	CATERPILLAR C13 DIESEL	2004-2007
				FREIGHTLINER	COLUMBIA	CATERPILLAR C11 DIESEL	2006-2007
				FREIGHTLINER	COLUMBIA	CATERPILLAR C13 DIESEL	2006-2006
				STERLING	ACTERRA	CATERPILLAR C13 DIESEL	2006-2006
				STERLING	A-LINE	CATERPILLAR C11 DIESEL	2004-2004
				STERLING	L-LINE	CATERPILLAR C11 DIESEL	2004-2007
				STERLING	L-LINE	CATERPILLAR C13 DIESEL	2006-2006
				STERLING	L-LINE	CATERPILLAR C15 DIESEL	2006-2006
				STERLING	L-LINE	CATERPILLAR C9 DIESEL	2007-2007

MARCA	MODELO	MOTOR	AÑOS	MARCA	MODELO	MOTOR	AÑOS				
 <p>22950 MANGUERA SUPERIOR</p>				CHEVROLET	T6500	ISUZU 6HK1-TC DIESEL	2005-2008				
				CHEVROLET	T7500	ISUZU 6HK1-TC DIESEL	2005-2008				
				CHEVROLET	T8500	ISUZU 6HK1-TC DIESEL	2005-2008				
				FREIGHTLINER	COLUMBIA	CATERPILLAR C11 DIESEL	2004-2004				
FREIGHTLINER	COLUMBIA	CATERPILLAR C13 DIESEL	2007-2009	 <p>22854 MANGUERA SUPERIOR</p>							
FREIGHTLINER	COLUMBIA	CATERPILLAR C13 DIESEL	2004-2005								
CHEVROLET	C6500	GM V8 8.1 L	2003-2007								
CHEVROLET	C7500	GM V8 8.1 L	2003-2007								
 <p>22903 MANGUERA INFERIOR</p>				CHEVROLET	C8500	GM V8 8.1 L	2003-2007				
				STERLING	ACTERRA	MERCEDES-BENZ MBE 900 DIESEL	2001-2004	 <p>22850 MANGUERA SUPERIOR</p>			
STERLING	ACTERRA	MERCEDES-BENZ MBE 900 DIESEL	2001-2003								
 <p>22893 MANGUERA INFERIOR</p>				STERLING	A-LINE	MERCEDES-BENZ MBE 4000 DIESEL	2004-2005				
				DODGE	RAM-4000	V6, 5.9 L DIESEL	2003-2008	STERLING	L-LINE	MERCEDES-BENZ MBE 4000 DIESEL	2003-2005
DODGE	RAM-4000	V6, 6.7 L DIESEL	2008-2011	 <p>22843 MANGUERA INFERIOR</p>							
 <p>22892 MANGUERA SUPERIOR</p>								INTERNATIONAL/NAVISTAR	3400	INTERNATIONAL/NAVISTAR T444 DIESEL	1999-1999
				DODGE	RAM-4000	V6, 5.9 L DIESEL	2003-2008	INTERNATIONAL/NAVISTAR	3800	INTERNATIONAL/NAVISTAR T444 DIESEL	1999-1999
DODGE	RAM-4000	V6, 6.7 L DIESEL	2008-2011	 <p>22785 MANGUERA SUPERIOR</p>							
 <p>22877 MANGUERA INFERIOR</p>								INTERNATIONAL/NAVISTAR	CE	INTERNATIONAL/NAVISTAR T444 DIESEL	2003-2004
				FREIGHTLINER	CENTURY CLASS	DETROIT DIESEL 6 CIL, 12.7 L DIESEL	2004-2005	 <p>22783 MANGUERA INFERIOR</p>			
FREIGHTLINER	CENTURY CLASS	DETROIT DIESEL 6 CIL, 14.0 L DIESEL	2004-2006								
FREIGHTLINER	COLUMBIA	DETROIT DIESEL 6 CIL, 12.7 L DIESEL	2004-2009	INTERNATIONAL/NAVISTAR	FE	INTERNATIONAL/NAVISTAR DT466	2002-2004				
FREIGHTLINER	COLUMBIA	DETROIT DIESEL 6 CIL, 14.0 L DIESEL	2004-2007	 <p>22782 MANGUERA INFERIOR</p>							
FREIGHTLINER	COLUMBIA	DETROIT DIESEL SERIE 60	2006-2006								
 <p>22856 MANGUERA INFERIOR</p>				INTERNATIONAL/NAVISTAR	3800	INTERNATIONAL/NAVISTAR T444 DIESEL	2000-2000				
				CHEVROLET	T6500	ISUZU 6HK1-TC DIESEL	2005-2007	INTERNATIONAL/NAVISTAR	CONVENTIONAL IC DIESEL	INTERNATIONAL/NAVISTAR T444	2002-2003
				CHEVROLET	T7500	ISUZU 6HK1-TC DIESEL	2005-2007	 <p>22780 MANGUERA INFERIOR</p>			
CHEVROLET	T8500	ISUZU 6HK1-TC DIESEL	2005-2007								
 <p>22855 MANGUERA SUPERIOR</p>				FORD	F-450 SUPER DUTY	FORD V8, 6.0 L DIESEL	2003-2005				
				FORD	F-450 SUPER DUTY	FORD V8, 6.0 L DIESEL	2005-2006				
				FORD	F-550 SUPER DUTY	FORD V8, 6.0 L DIESEL	2003-2005				

MARCA	MODELO	MOTOR	AÑOS
22768 MANGUERA INFERIOR			
CHEVROLET	C6500	ISUZU 6HK1-TC DIESEL	2003-2007
CHEVROLET	C7500	ISUZU 6HK1-TC DIESEL	2003-2007
CHEVROLET	C8500	ISUZU 6HK1-TC DIESEL	2003-2007

MARCA	MODELO	MOTOR	AÑOS
22767 MANGUERA SUPERIOR			
CHEVROLET	C6500	ISUZU 6HK1-TC DIESEL	2003-2007
CHEVROLET	C7500	ISUZU 6HK1-TC DIESEL	2003-2007
CHEVROLET	C8500	ISUZU 6HK1-TC DIESEL	2003-2007

MARCA	MODELO	MOTOR	AÑOS
22766 MANGUERA INFERIOR			
CHEVROLET	C6500	CATERPILLAR 3126 DIESEL	2003-2003
CHEVROLET	C7500	CATERPILLAR 3126 DIESEL	2003-2003
CHEVROLET	C8500	CATERPILLAR 3126 DIESEL	2003-2003

MARCA	MODELO	MOTOR	AÑOS
22765 MANGUERA SUPERIOR			
CHEVROLET	C6500	CATERPILLAR 3126 DIESEL	2003-2003
CHEVROLET	C7500	CATERPILLAR 3126 DIESEL	2003-2003
CHEVROLET	C8500	CATERPILLAR 3126 DIESEL	2003-2003

MARCA	MODELO	MOTOR	AÑOS
22764 MANGUERA SUPERIOR			
CHEVROLET	C6500	CATERPILLAR 3126 DIESEL	2003-2003
CHEVROLET	C7500	CATERPILLAR 3126 DIESEL	2003-2003
CHEVROLET	C8500	CATERPILLAR 3126 DIESEL	2003-2003

MARCA	MODELO	MOTOR	AÑOS
22763 MANGUERA SUPERIOR			
CHEVROLET	C4500	GM V8 6.6 L DIESEL	2003-2007
CHEVROLET	C5500	GM V8 6.6 L DIESEL	2003-2007

MARCA	MODELO	MOTOR	AÑOS
22762 MANGUERA INFERIOR			

MARCA	MODELO	MOTOR	AÑOS
INTERNATIONAL/NAVISTAR	3800	INTERNATIONAL/NAVISTAR DT466	1998-1998
INTERNATIONAL/NAVISTAR	3800	INTERNATIONAL/NAVISTAR DT466	1999-2000
INTERNATIONAL/NAVISTAR	7400	INTERNATIONAL/NAVISTAR 530 DIESEL	2002-2003
INTERNATIONAL/NAVISTAR	7400	INTERNATIONAL/NAVISTAR DT466	2002-2003
INTERNATIONAL/NAVISTAR	7400	INTERNATIONAL/NAVISTAR DT530 DIESEL	2004-2005
INTERNATIONAL/NAVISTAR	7500	INTERNATIONAL/NAVISTAR 530 DIESEL	2002-2003
INTERNATIONAL/NAVISTAR	7500	INTERNATIONAL/NAVISTAR DT466	2002-2002
INTERNATIONAL/NAVISTAR	7500	INTERNATIONAL/NAVISTAR DT530 DIESEL	2004-2005

MARCA	MODELO	MOTOR	AÑOS
22745 MANGUERA SUPERIOR			
FREIGHTLINER	BUSINESS CLASS M2	CATERPILLAR 3126 DIESEL	2002-2007
FREIGHTLINER	BUSINESS CLASS M2	CATERPILLAR C7 DIESEL	2004-2007

MARCA	MODELO	MOTOR	AÑOS
22744 MANGUERA INFERIOR			
FREIGHTLINER	BUSINESS CLASS M2	CATERPILLAR 3126 DIESEL	2002-2004
FREIGHTLINER	BUSINESS CLASS M2	CATERPILLAR C7 DIESEL	2004-2004













MARCA	MODELO	MOTOR	AÑOS
22742 MANGUERA INFERIOR			
INTERNATIONAL/NAVISTAR	4300	INTERNATIONAL/NAVISTAR DT466	2002-2008
INTERNATIONAL/NAVISTAR	4400	INTERNATIONAL/NAVISTAR 530 DIESEL	2002-2005
INTERNATIONAL/NAVISTAR	4400	INTERNATIONAL/NAVISTAR DT466	2002-2005
INTERNATIONAL/NAVISTAR	5500	CUMMINS ISM DIESEL	2005-2005













MARCA	MODELO	MOTOR	AÑOS
22726 MANGUERA SUPERIOR			
VOLVO	VNL	CUMMINS N14 DIESEL	2001-2002

MARCA	MODELO	MOTOR	AÑOS
22725 MANGUERA INFERIOR			
VOLVO	VHD	VOLVO VE 12 DIESEL	2002-2002
VOLVO	VHD	VOLVO VE D12 DIESEL	2001-2002

MARCA	MODELO	MOTOR	AÑOS
22724 MANGUERA SUPERIOR			
VOLVO	VHD	VOLVO VE 12 DIESEL	2002-2002
VOLVO	VHD	VOLVO VE D12 DIESEL	2001-2002

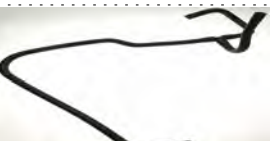











MARCA	MODELO	MOTOR	AÑOS	MARCA	MODELO	MOTOR	AÑOS
 22717 MANGUERA INFERIOR				VOLVO	VNL	CUMMINS ISX DIESEL	2004-2013
				VOLVO	VNL	CUMMINS ISX DIESEL	2000-2002
				VOLVO	VNM	CUMMINS ISX DIESEL	2006-2013
				VOLVO	VNL	CUMMINS ISX DIESEL	2004-2008
 22716 MANGUERA SUPERIOR				VOLVO	VNL	CUMMINS ISX DIESEL	2000-2002
				VOLVO	VNM	CUMMINS ISX DIESEL	2006-2008
 22715 MANGUERA INFERIOR				VOLVO	WG SERIES	VOLVO VE D12 DIESEL	1998-2001
				VOLVO	VNL	CUMMINS ISX DIESEL	2004-2008
				VOLVO	VNL	CUMMINS ISX DIESEL	1998-2003
				VOLVO	VNM	CUMMINS ISX DIESEL	2006-2008
 22714 MANGUERA SUPERIOR				MACK	CHU SERIES	MACK MP8 DIESEL	2008-2010
				MACK	CXU SERIES	MACK MP8 DIESEL	2008-2010
				MACK	GRANITE	MACK MP8 DIESEL	2011-2013
				MACK	GU SERIES	MACK MP8 DIESEL	2008-2010
				VOLVO	VNL	VOLVO D13 DIESEL	2008-2014
				VOLVO	VNM	VOLVO D13 DIESEL	2008-2014
				VOLVO	WG SERIES	VOLVO VE D12 DIESEL	1998-2001
 22713 MANGUERA SUPERIOR				VOLVO	WG SERIES	VOLVO VE D12 DIESEL	1998-2001
				VOLVO	VNL	CUMMINS ISX DIESEL	2004-2008
 22712 MANGUERA INFERIOR				VOLVO	VHD	CUMMINS ISM DIESEL	2002-2003
				VOLVO	VNM	CUMMINS ISX DIESEL	2006-2008
 22711 MANGUERA SUPERIOR				VOLVO	VHD	CUMMINS ISM DIESEL	2002-2003
				VOLVO	VNM	CUMMINS ISX DIESEL	2006-2008
 22710 MANGUERA INFERIOR				VOLVO	VHD	VOLVO VE D12 DIESEL	2003-2004
				VOLVO	VNL	VOLVO VE 12 DIESEL	2000-2000
				VOLVO	VNL	VOLVO VE D12 DIESEL	2004-2008
				VOLVO	VNL	VOLVO VE D12 DIESEL	1998-2003
 22709 MANGUERA SUPERIOR				VOLVO	VHD	VOLVO VE D12 DIESEL	2003-2004
				VOLVO	VNL	VOLVO VE 12 DIESEL	2000-2000
				VOLVO	VNL	VOLVO VE D12 DIESEL	2004-2008
				VOLVO	VNL	VOLVO VE D12 DIESEL	1998-2003
 22707 MANGUERA INFERIOR				VOLVO	VNM	VOLVO VE D12 DIESEL	2006-2008
				KENWORTH	T300	CATERPILLAR 3126 DIESEL	1996-2003
				STERLING	L-LINE	CATERPILLAR C15 DIESEL	2008-2008
 22701 MANGUERA SUPERIOR				STERLING	ACTERRA	MERCEDES-BENZ MBE 900 DIESEL	2001-2004
				VOLVO	VNL	CUMMINS ISX DIESEL	2004-2008
 22690 MANGUERA INFERIOR				FORD	F-450 SUPER DUTY	FORD V8, 7.3 L DIESEL	2001-2003
				FORD	F-550 SUPER DUTY	FORD V8, 7.3 L DIESEL	2001-2004
 22679 MANGUERA INFERIOR				CHEVROLET	C5500	GM V8 8.1 L	2001-2002
				CHEVROLET	C6500	GM V8 8.1 L	2001-2002
				CHEVROLET	C7500	GM V8 8.1 L	2001-2002
				CHEVROLET	C8500	GM V8 8.1 L	2001-2002
				CHEVROLET	KODIAK	GM V8, 8.1 L	2001-2008
				CHEVROLET	CHEVROLET	GM V8 8.1 L	2001-2002

MARCA	MODELO	MOTOR	AÑOS	MARCA	MODELO	MOTOR	AÑOS
 22678 MANGUERA SUPERIOR				CHEVROLET	C5500	GM V8 8.1 L	2001-2002
				CHEVROLET	C6500	GM V8 8.1 L	2001-2002
				CHEVROLET	C7500	GM V8 8.1 L	2001-2002
				CHEVROLET	C8500	GM V8 8.1 L	2001-2002
				CHEVROLET	KODIAK	GM V8, 8.1 L	2001-2008
 22671 MANGUERA INFERIOR				INTERNATIONAL/NAVISTAR	3800	INTERNATIONAL/NAVISTAR T444 DIESEL	1998-1998
				INTERNATIONAL/NAVISTAR	4600	INTERNATIONAL/NAVISTAR T444 DIESEL	1995-1995
				INTERNATIONAL/NAVISTAR	4700	INTERNATIONAL/NAVISTAR T444 DIESEL	2001-2002
				INTERNATIONAL/NAVISTAR	4700	INTERNATIONAL/NAVISTAR T444 DIESEL	1995-2000
				INTERNATIONAL/NAVISTAR	4800	INTERNATIONAL/NAVISTAR T444 DIESEL	1995-1997
				INTERNATIONAL/NAVISTAR	4900	INTERNATIONAL/NAVISTAR T444 DIESEL	1995-1997
 22668 MANGUERA SUPERIOR				STERLING	ACTERRA	CATERPILLAR C7 DIESEL	2004-2005
 22664 MANGUERA SUPERIOR				CHEVROLET	C5500	CATERPILLAR 3126 DIESEL	1998-2002
				CHEVROLET	C6500	CATERPILLAR 3126 DIESEL	1998-2002
				CHEVROLET	C7500	CATERPILLAR 3126 DIESEL	1998-2002
				CHEVROLET	C8500	CATERPILLAR 3126 DIESEL	1998-2002
				CHEVROLET	KODIAK	CATERPILLAR 3116 DIESEL	2000-2000
				CHEVROLET	KODIAK	CATERPILLAR 3126 DIESEL	2000-2008
 22663 MANGUERA SUPERIOR				CHEVROLET	C5500	GM V8 7.4 L	1999-2000
				CHEVROLET	C6500	GM V8 7.4 L	1999-2000
				CHEVROLET	C7500	GM V8 7.4 L	1999-2000
				CHEVROLET	C8500	GM V8 7.4 L	1999-2000
				CHEVROLET	KODIAK	GM V8, 7.4 L	1995-2000
 22654 MANGUERA INFERIOR				FORD	RANGER	4 CIL, 2.3 L	2001-2012
 22653 MANGUERA SUPERIOR				FORD	RANGER	4 CIL, 2.3 L	2001-2004
 22646 MANGUERA SUPERIOR				FORD	RANGER	V6, 4.0 L	2001-2001
 22624 MANGUERA DE CALEFACCIÓN				FORD	E450 SUPER DUTY	FORD V8, 5.4 L	2000-2000
 22614 MANGUERA DE CALEFACCIÓN				FORD	E450 SUPER DUTY	FORD V8, 5.4 L	2000-2000
 22542 MANGUERA SUPERIOR				FORD	F-450 SUPER DUTY	FORD V8, 7.3 L DIESEL	1999-2003
				FORD	F-550 SUPER DUTY	FORD V8, 7.3 L DIESEL	1999-2004
 22469 MANGUERA DE CALEFACCIÓN				FORD	RANGER	V6, 3.0 L	2001-2001
 22468 MANGUERA DE CALEFACCIÓN				FORD	RANGER	V6, 3.0 L	2000-2001
 22434 MANGUERA INFERIOR							











MASTER SERVICIO PESADO 2014









MANGUERAS

MARCA	MODELO	MOTOR	AÑOS	MARCA	MODELO	MOTOR	AÑOS
FORD	F-450 SUPER DUTY	FORD V8, 7.3 L DIESEL	1999-2000	FORD	F-600	FORD V8, 7.0 L	1992-1994
FORD	F-450 SUPER DUTY	V8, 7.3 L	1999-2003			22380 MANGUERA SUPERIOR	
FORD	F-550 SUPER DUTY	FORD V8, 7.3 L DIESEL	1999-2000				
		22433 MANGUERA SUPERIOR		FORD	RANGER	4 CIL, 2.5 L	1996-2001
FORD	F-450 SUPER DUTY	FORD V8, 7.3 L DIESEL	1999-2003			22371 MANGUERA INFERIOR	
FORD	F-450 SUPER DUTY	V8, 7.3 L	1999-2003				
FORD	F-550 SUPER DUTY	FORD V8, 7.3 L DIESEL	1999-2004	FORD	E450 SUPER DUTY	FORD V10, 6.8 L	1999-2001
		22432 MANGUERA DE ENFRIAMIENTO				22364 MANGUERA INFERIOR	
FORD	F-350 SUPER DUTY	V10, 6.8 L	2003-2004				
FORD	F-450 SUPER DUTY	FORD V10, 6.8 L	1999-2005	FORD	RANGER	4 CIL, 2.5 L	1996-2001
FORD	F-450 SUPER DUTY	V10, 6.8 L	2000-2000			22356 MANGUERA SUPERIOR	
FORD	F-550 SUPER DUTY	FORD V10, 6.8 L	1999-2005				
		22431 MANGUERA DE ENFRIAMIENTO		CHEVROLET	S-10	4 CIL, 2.2 L	1998-2003
FORD	F-350 SUPER DUTY	V10, 6.8 L	2004-2004			22351 MANGUERA INFERIOR	
FORD	F-450 SUPER DUTY	FORD V10, 6.8 L	1999-2005				
FORD	F-450 SUPER DUTY	V10, 6.8 L	1999-2000	FORD	RANGER	V6, 3.0 L	1998-2002
FORD	F-550 SUPER DUTY	FORD V10, 6.8 L	1999-2005			22350 MANGUERA INFERIOR	
		22430 MANGUERA DE ENFRIAMIENTO					
FORD	F-350 SUPER DUTY	V8, 5.4 L	2004-2004	FORD	RANGER	V6, 4.0 L	1999-2001
FORD	F-350 SUPER DUTY	V8, 5.4 L	2003-2006			22349 MANGUERA SUPERIOR	
FORD	F-450 SUPER DUTY	V8, 5.4 L	2003-2004				
FORD	F-450 SUPER DUTY	V8, 5.4 L	1999-2000	FORD	RANGER	V6, 4.0 L	1999-2000
		22429 MANGUERA DE ENFRIAMIENTO				22322 MANGUERA SUPERIOR	
FORD	F-350 SUPER DUTY	V8, 5.4 L	2004-2004				
FORD	F-350 SUPER DUTY	V8, 5.4 L	2004-2006	MACK	CS SERIES	MACK AC DIESEL	2003-2003
FORD	F-450 SUPER DUTY	V8, 5.4 L	1999-2000			22319 MANGUERA INFERIOR	
		22400 MANGUERA INFERIOR					

MARCA	MODELO	MOTOR	AÑOS	MARCA	MODELO	MOTOR	AÑOS
FORD	E450 SUPER DUTY	FORD V8, 7.3 L DIESEL	1998-2001	VOLVO	WCA SERIES	CUMMINS M11 DIESEL	1996-1997
FORD	E450 SUPER DUTY	FORD V8, 7.3 L DIESEL	2002-2003	VOLVO	WG SERIES	CUMMINS L10 DIESEL	1996-1997
FORD	E550 SUPER DUTY	FORD V8, 7.3 L DIESEL	2002-2003	VOLVO	WG SERIES	CUMMINS M11 DIESEL	1996-1996
	22318 MANGUERA INFERIOR				22159 MANGUERA SUPERIOR		
FORD	E450 SUPER DUTY	FORD V8, 5.4 L	2000-2001	INTERNATIONAL/NAVISTAR	3400	INTERNATIONAL/NAVISTAR T444 DIESEL	1998-1999
	22316 MANGUERA SUPERIOR			INTERNATIONAL/NAVISTAR	3800	INTERNATIONAL/NAVISTAR T444 DIESEL	2001-2001
FORD	E450 SUPER DUTY	FORD V10, 6.8 L	1999-2001	INTERNATIONAL/NAVISTAR	3800	INTERNATIONAL/NAVISTAR T444 DIESEL	2000-2000
	22315 MANGUERA SUPERIOR			INTERNATIONAL/NAVISTAR	4600	INTERNATIONAL/NAVISTAR T444 DIESEL	1995-1995
FORD	E450 SUPER DUTY	FORD V10, 6.8 L	2002-2009	INTERNATIONAL/NAVISTAR	4700	INTERNATIONAL/NAVISTAR T444 DIESEL	1995-2002
FORD	E450 SUPER DUTY	FORD V8, 5.4 L	2000-2003	INTERNATIONAL/NAVISTAR	4800	INTERNATIONAL/NAVISTAR T444 DIESEL	1995-1997
FORD	E550 SUPER DUTY	FORD V10, 6.8 L	2002-2003	INTERNATIONAL/NAVISTAR	4900	INTERNATIONAL/NAVISTAR T444 DIESEL	1995-1997
	22312 MANGUERA SUPERIOR				22156 MANGUERA INFERIOR		
FORD	E450 SUPER DUTY	FORD V8, 7.3 L DIESEL	1998-2003	FORD	RANGER	4 CIL, 2.3 L	1996-1997
FORD	E550 SUPER DUTY	FORD V8, 7.3 L DIESEL	2002-2003		22155 MANGUERA SUPERIOR		
	22297 MANGUERA INFERIOR			FORD	RANGER	4 CIL, 2.3 L	1996-1997
FORD	E450 SUPER DUTY	FORD V8, 5.4 L	2003-2003		22144 MANGUERA SUPERIOR		
FORD	E450 SUPER DUTY	FORD V8, 5.4 L	2003-2003	FORD	RANGER	V6, 3.0 L	1996-2002
	22254 MANGUERA INFERIOR				22140 MANGUERA SUPERIOR		
FORD	RANGER	V6, 3.0 L	1996-1996	INTERNATIONAL/NAVISTAR	3800	INTERNATIONAL/NAVISTAR DT466	1998-2001
	22196 MANGUERA SUPERIOR			INTERNATIONAL/NAVISTAR	4700	INTERNATIONAL/NAVISTAR 530 DIESEL	1999-2002
CHEVROLET	S-10	V6, 4.3 L	1996-2002	INTERNATIONAL/NAVISTAR	4700	INTERNATIONAL/NAVISTAR DT408 DIESEL	1995-1997
	22177 MANGUERA SUPERIOR			INTERNATIONAL/NAVISTAR	4700	INTERNATIONAL/NAVISTAR DT466	2000-2002
				INTERNATIONAL/NAVISTAR	4800	INTERNATIONAL/NAVISTAR 530 DIESEL	2002-2002
				INTERNATIONAL/NAVISTAR	4800	INTERNATIONAL/NAVISTAR DT408 DIESEL	1995-1997
				INTERNATIONAL/NAVISTAR	4900	INTERNATIONAL/NAVISTAR 530 DIESEL	1995-2002
				INTERNATIONAL/NAVISTAR	4900	INTERNATIONAL/NAVISTAR DT408 DIESEL	1995-1997
				INTERNATIONAL/NAVISTAR	4900	INTERNATIONAL/NAVISTAR DT466	2000-2001

MARCA	MODELO	MOTOR	AÑOS	MARCA	MODELO	MOTOR	AÑOS								
 <p>22136 MANGUERA SUPERIOR</p>				 <p>22083 MANGUERA INFERIOR</p>											
								CHEVROLET	C5500	GM V8 6.0 L	1997-1998	DODGE	RAM-4000	V6, 5.9 L DIESEL	2002-2002
								CHEVROLET	C5500	GM V8 7.0 L	1997-1998	 <p>22043 MANGUERA SUPERIOR</p>			
								CHEVROLET	C6500	GM V8 6.0 L	1997-1998				
								CHEVROLET	C6500	GM V8 7.0 L	1997-1998				
								CHEVROLET	C7500	GM V8 6.0 L	1997-1998				
								CHEVROLET	C7500	GM V8 7.0 L	1997-1998				
								CHEVROLET	C8500	GM V8 6.0 L	1997-1998				
CHEVROLET	C8500	GM V8 7.0 L	1997-1998												
 <p>22135 MANGUERA INFERIOR</p>				 <p>22039 MANGUERA INFERIOR</p>											
								CHEVROLET	C5500	GM V8 6.0 L	1997-1997	CHEVROLET	S-10	V6, 4.3 L	1992-2002
								CHEVROLET	C5500	GM V8 7.0 L	1997-1997	 <p>22038 MANGUERA DE PASO</p>			
								CHEVROLET	C5500	GM V8 7.4 L	1999-2000				
								CHEVROLET	C6500	GM V8 6.0 L	1997-1997				
								CHEVROLET	C6500	GM V8 7.0 L	1997-1997				
								CHEVROLET	C6500	GM V8 7.4 L	1999-2000				
								CHEVROLET	C7500	GM V8 6.0 L	1997-1997				
								CHEVROLET	C7500	GM V8 7.0 L	1997-1997				
								CHEVROLET	C7500	GM V8 7.4 L	1999-2000				
								CHEVROLET	C8500	GM V8 6.0 L	1997-1997				
								CHEVROLET	C8500	GM V8 7.0 L	1997-1997				
								CHEVROLET	C8500	GM V8 7.4 L	1999-2000				
								CHEVROLET	KODIAK	GM V8, 7.4 L	1995-2000				
 <p>22134 MANGUERA SUPERIOR</p>				 <p>22037 MANGUERA INFERIOR</p>											
								CHEVROLET	C6500	CATERPILLAR 3116 DIESEL	1997-1998				
								CHEVROLET	C7500	CATERPILLAR 3116 DIESEL	1997-1998	 <p>22033 MANGUERA INFERIOR</p>			
								CHEVROLET	C8500	CATERPILLAR 3116 DIESEL	1997-1998				
 <p>22101 MANGUERA SUPERIOR</p>				 <p>22032 MANGUERA SUPERIOR</p>											
								INTERNATIONAL/NAVISTAR	8100	INTERNATIONAL/NAVISTAR DT466	1995-1995				
								<p>22032 MANGUERA SUPERIOR</p>				CHEVROLET	C5500	CATERPILLAR 3126 DIESEL	1998-2002
												CHEVROLET	C6500	CATERPILLAR 3116 DIESEL	1997-2000
												CHEVROLET	C6500	CATERPILLAR 3126 DIESEL	1998-2002
												CHEVROLET	C7500	CATERPILLAR 3116 DIESEL	1997-2000
												CHEVROLET	C7500	CATERPILLAR 3126 DIESEL	1998-2002
												CHEVROLET	C8500	CATERPILLAR 3116 DIESEL	1997-2000
												CHEVROLET	C8500	CATERPILLAR 3126 DIESEL	1998-2002
												CHEVROLET	C8500	CATERPILLAR 3116 DIESEL	1997-2000
												CHEVROLET	C8500	CATERPILLAR 3126 DIESEL	1998-2002
CHEVROLET	KODIAK	CATERPILLAR 3116 DIESEL	1997-1999												

MARCA	MODELO	MOTOR	AÑOS	MARCA	MODELO	MOTOR	AÑOS
				22031 MANGUERA SUPERIOR			
CHEVROLET	C5500	GM V8 6.0 L	1997-1998	CHEVROLET	C5500	CATERPILLAR 3116 DIESEL	1999-1999
CHEVROLET	C5500	GM V8 7.0 L	1997-1998	CHEVROLET	C5500	CATERPILLAR 3126 DIESEL	1998-2002
CHEVROLET	C6500	GM V8 6.0 L	1997-1998	CHEVROLET	C6500	CATERPILLAR 3116 DIESEL	1997-2000
CHEVROLET	C6500	GM V8 7.0 L	1997-1998	CHEVROLET	C6500	CATERPILLAR 3126 DIESEL	1998-2002
CHEVROLET	C7500	GM V8 6.0 L	1997-1998	CHEVROLET	C7500	CATERPILLAR 3116 DIESEL	1997-2000
CHEVROLET	C7500	GM V8 7.0 L	1997-1998	CHEVROLET	C7500	CATERPILLAR 3126 DIESEL	1998-2002
CHEVROLET	C8500	GM V8 6.0 L	1997-1998	CHEVROLET	C8500	CATERPILLAR 3116 DIESEL	1997-2000
CHEVROLET	C8500	GM V8 7.0 L	1997-1998	CHEVROLET	C8500	CATERPILLAR 3126 DIESEL	1998-2002
				22030 MANGUERA INFERIOR			
CHEVROLET	C5500	GM V8 6.0 L	1997-1998	CHEVROLET	KODIAK	CATERPILLAR 3116 DIESEL	1997-2000
CHEVROLET	C5500	GM V8 7.0 L	1997-1998	CHEVROLET	KODIAK	CATERPILLAR 3126 DIESEL	2000-2008
CHEVROLET	C6500	GM V8 6.0 L	1997-1998				
CHEVROLET	C6500	GM V8 7.0 L	1997-1998				
CHEVROLET	C7500	GM V8 6.0 L	1997-1998	FORD	F-600	FORD 6 CIL, 6.6 L DIESEL	1991-1993
CHEVROLET	C7500	GM V8 7.0 L	1997-1998	FORD	F-600	FORD 6 CIL, 7.8 L DIESEL	1991-1993
CHEVROLET	C8500	GM V8 6.0 L	1997-1998				
CHEVROLET	C8500	GM V8 7.0 L	1997-1998				
CHEVROLET	C8500	GM V8 6.0 L	1997-1998	FORD	F-600	FORD 6 CIL, 6.6 L DIESEL	1991-1993
CHEVROLET	C8500	GM V8 7.0 L	1997-1998	FORD	F-600	FORD 6 CIL, 7.8 L DIESEL	1991-1991
				21989 MANGUERA SUPERIOR			
CHEVROLET	C5500	CATERPILLAR 3116 DIESEL	1999-1999				
CHEVROLET	C6500	CATERPILLAR 3116 DIESEL	1997-2000				
CHEVROLET	C7500	CATERPILLAR 3116 DIESEL	1997-2000	FORD	RANGER	4 CIL, 2.3 L	2006-2012
CHEVROLET	C8500	CATERPILLAR 3116 DIESEL	1997-2000				
				21987 MANGUERA INFERIOR			
CHEVROLET	C5500	GM V8 6.0 L	1997-1998	FORD	F-600	FORD 6 CIL, 6.6 L DIESEL	1991-1993
CHEVROLET	C5500	GM V8 7.0 L	1997-1998	FORD	F-600	FORD 6 CIL, 7.8 L DIESEL	1991-1993
CHEVROLET	C6500	GM V8 6.0 L	1997-1998				
CHEVROLET	C6500	GM V8 7.0 L	1997-1998				
CHEVROLET	C7500	GM V8 6.0 L	1997-1998	FORD	F-600	FORD V8, 6.1 L	1991-1991
CHEVROLET	C7500	GM V8 7.0 L	1997-1998	FORD	F-600	FORD V8, 7.0 L	1991-1994
CHEVROLET	C8500	GM V8 6.0 L	1997-1998				
CHEVROLET	C8500	GM V8 7.0 L	1997-1998				

MARCA	MODELO	MOTOR	AÑOS	MARCA	MODELO	MOTOR	AÑOS
 <p>21940 MANGUERA SUPERIOR</p>				STERLING	SILVER STAR	CUMMINS SIGNATURE 600 DIESEL	2001-2001
				 <p>21891 MANGUERA INFERIOR</p>			
FREIGHTLINER	FLD	CATERPILLAR C10 DIESEL	1997-1997	FREIGHTLINER	ARGOSY	CATERPILLAR 3406 DIESEL	1999-2000
FREIGHTLINER	FLD	CATERPILLAR C12 DIESEL	1996-1997	FREIGHTLINER	ARGOSY	CATERPILLAR C15 DIESEL	2001-2004
 <p>21938 MANGUERA SUPERIOR</p>				FREIGHTLINER	ARGOSY	CUMMINS ISM DIESEL	1999-1999
				FREIGHTLINER	ARGOSY	DETROIT DIESEL 6 CIL, 11.1 L DIESEL	1999-2003
FORD	F-600	FORD V8, 6.1 L	1991-1991	FREIGHTLINER	ARGOSY	DETROIT DIESEL 6 CIL, 12.7 L DIESEL	1999-2008
FORD	F-600	FORD V8, 7.0 L	1991-1994	FREIGHTLINER	ARGOSY	DETROIT DIESEL 6 CIL, 14.0 L DIESEL	2001-2008
 <p>21936 MANGUERA SUPERIOR</p>				FREIGHTLINER	BUSINESS CLASS M2	CATERPILLAR C13 DIESEL	2009-2010
				FREIGHTLINER	BUSINESS CLASS M2	CUMMINS ISC DIESEL	2004-2004
FORD	F-600	FORD V8, 6.1 L	1991-1991	FREIGHTLINER	CASCADIA	DETROIT DIESEL 6 CIL, 14.0 L DIESEL	2008-2010
FORD	F-600	FORD V8, 7.0 L	1991-1994	FREIGHTLINER	CASCADIA	MERCEDES BENZ MBE 4000 Diesel	2008-2012
 <p>21936 MANGUERA SUPERIOR</p>				FREIGHTLINER	CENTURY CLASS	CATERPILLAR C10 DIESEL	1996-1997
				FREIGHTLINER	CENTURY CLASS	CATERPILLAR C12 DIESEL	1996-1996
 <p>21909 MANG. INFERIOR</p>				FREIGHTLINER	CENTURY CLASS	CATERPILLAR C12 DIESEL	1997-1997
				FREIGHTLINER	CENTURY CLASS	CATERPILLAR C15 DIESEL	2005-2006
FORD	F-450 SUPER DUTY	V8, 7.5 L	1997-1997	FREIGHTLINER	CENTURY CLASS	CUMMINS ISM DIESEL	2001-2001
 <p>21901 MANGUERA INFERIOR</p>				FREIGHTLINER	CENTURY CLASS	CUMMINS ISX DIESEL	2001-2001
				FREIGHTLINER	CENTURY CLASS	DETROIT DIESEL 6 CIL, 11.1 L DIESEL	1998-2003
FORD	F-600	CUMMINS C Series 8.3 L DIESEL	1993-1994	FREIGHTLINER	CENTURY CLASS	DETROIT DIESEL 6 CIL, 12.7 L DIESEL	1998-2003
KENWORTH	K100	CUMMINS C Series 8.3 L DIESEL	1992-1993	FREIGHTLINER	CENTURY CLASS	DETROIT DIESEL 6 CIL, 14.0 L DIESEL	2003-2003
KENWORTH	K300	CUMMINS C Series 8.3 L DIESEL	1995-1995	FREIGHTLINER	CENTURY CLASS	DETROIT DIESEL SERIE 60	1998-2003
 <p>21897 MANGUERA INFERIOR</p>				FREIGHTLINER	CENTURY CLASS	MERCEDES BENZ MBE 4000 Diesel	2009-2010
				FREIGHTLINER	CENTURY CLASS	MERCEDES-BENZ MBE 4000 DIESEL	2004-2005
FORD	F-600	CUMMINS C Series 8.3 L DIESEL	1993-1994	FREIGHTLINER	CLASSIC	DETROIT DIESEL 6 CIL, 14.0 L DIESEL	2008-2008
KENWORTH	K100	CUMMINS C Series 8.3 L DIESEL	1992-1993	FREIGHTLINER	CLASSIC	MERCEDES BENZ MBE 4000 Diesel	2009-2010
KENWORTH	K300	CUMMINS C Series 8.3 L DIESEL	1995-1995	FREIGHTLINER	CLASSIC XL	CATERPILLAR C15 DIESEL	2005-2005
 <p>21897 MANGUERA INFERIOR</p>				FREIGHTLINER	CLASSIC XL	DETROIT DIESEL 6 CIL, 14.0 L DIESEL	2008-2008
				FREIGHTLINER	CLASSIC XL	MERCEDES BENZ MBE 4000 Diesel	2009-2010
INTERNATIONAL/NAVISTAR	8100	CATERPILLAR 3406 DIESEL	1998-1998	FREIGHTLINER	COLUMBIA	CATERPILLAR C10 DIESEL	2001-2003
 <p>21894 MANGUERA INFERIOR</p>				FREIGHTLINER	COLUMBIA	CATERPILLAR C10 DIESEL	2001-2003
				FREIGHTLINER	COLUMBIA	CATERPILLAR C12 DIESEL	2003-2003
INTERNATIONAL/NAVISTAR	7600	CATERPILLAR C11 DIESEL	2006-2007	FREIGHTLINER	COLUMBIA	CATERPILLAR C12 DIESEL	2003-2003
INTERNATIONAL/NAVISTAR	7600	CATERPILLAR C13 DIESEL	2006-2008	FREIGHTLINER	COLUMBIA	CATERPILLAR C12 DIESEL	2003-2003
INTERNATIONAL/NAVISTAR	7700	CATERPILLAR C11 DIESEL	2006-2006	FREIGHTLINER	COLUMBIA	CATERPILLAR C15 DIESEL	2006-2007
INTERNATIONAL/NAVISTAR	7700	CATERPILLAR C13 DIESEL	2006-2006	FREIGHTLINER	COLUMBIA	CATERPILLAR C15 DIESEL	2005-2005
STERLING	L-LINE	CUMMINS ISX DIESEL	2001-2001	FREIGHTLINER	COLUMBIA	CUMMINS ISX DIESEL	2001-2001
STERLING	L-LINE	CUMMINS SIGNATURE 600 DIESEL	2001-2001	FREIGHTLINER	COLUMBIA	DETROIT DIESEL 6 CIL, 11.1 L DIESEL	2000-2001
				FREIGHTLINER	COLUMBIA	DETROIT DIESEL 6 CIL, 12.7 L DIESEL	2000-2003



MASTER SERVICIO PESADO 2014

MANGUERAS



MARCA	MODELO	MOTOR	AÑOS	MARCA	MODELO	MOTOR	AÑOS
FREIGHTLINER	COLUMBIA	DETROIT DIESEL 6 CIL., 14.0 L DIESEL	2002-2003	INTERNATIONAL/NAVISTAR	5500I	CATERPILLAR C12 DIESEL	2003-2004
FREIGHTLINER	COLUMBIA	DETROIT DIESEL SERIE 60	2001-2003	INTERNATIONAL/NAVISTAR	5500I	CATERPILLAR C12 DIESEL	2003-2004
FREIGHTLINER	COLUMBIA	MERCEDES BENZ MBE 4000 Diesel	2008-2010	INTERNATIONAL/NAVISTAR	5500I	CUMMINS ISM DIESEL	2005-2006
FREIGHTLINER	COLUMBIA	MERCEDES-BENZ MBE 4000 DIESEL	2003-2004	INTERNATIONAL/NAVISTAR	5500I	CUMMINS N14 DIESEL	2002-2003
FREIGHTLINER	CORONADO	CATERPILLAR C15 DIESEL	2002-2004	INTERNATIONAL/NAVISTAR	5500I	CUMMINS N14 DIESEL	2002-2003
FREIGHTLINER	CORONADO	CATERPILLAR C15 DIESEL	2008-2008	INTERNATIONAL/NAVISTAR	5600	CUMMINS ISM DIESEL	2005-2005
FREIGHTLINER	CORONADO	CATERPILLAR C15 DIESEL	2002-2006	INTERNATIONAL/NAVISTAR	5600I	CATERPILLAR C10 DIESEL	2003-2004
FREIGHTLINER	CORONADO	CATERPILLAR C16 DIESEL	2002-2003	INTERNATIONAL/NAVISTAR	5600I	CATERPILLAR C10 DIESEL	2003-2004
FREIGHTLINER	CORONADO	CATERPILLAR C16 DIESEL	2002-2003	INTERNATIONAL/NAVISTAR	5600I	CATERPILLAR C10 DIESEL	2003-2004
FREIGHTLINER	FL112	CATERPILLAR C10 DIESEL	2000-2004	INTERNATIONAL/NAVISTAR	5600I	CATERPILLAR C12 DIESEL	2003-2004
FREIGHTLINER	FL112	CATERPILLAR C10 DIESEL	2002-2002	INTERNATIONAL/NAVISTAR	5600I	CATERPILLAR C12 DIESEL	2003-2004
FREIGHTLINER	FL112	CATERPILLAR C10 DIESEL	2001-2002	INTERNATIONAL/NAVISTAR	5600I	CATERPILLAR C12 DIESEL	2003-2004
FREIGHTLINER	FL112	CATERPILLAR C10 DIESEL	2000-2004	INTERNATIONAL/NAVISTAR	5600I	CUMMINS ISM DIESEL	2005-2006
FREIGHTLINER	FL112	CATERPILLAR C12 DIESEL	2000-2003	INTERNATIONAL/NAVISTAR	5600I	CUMMINS ISX DIESEL	2007-2007
FREIGHTLINER	FL112	CATERPILLAR C12 DIESEL	2001-2002	INTERNATIONAL/NAVISTAR	5600I	CUMMINS N14 DIESEL	2002-2003
FREIGHTLINER	FL112	CATERPILLAR C12 DIESEL	2000-2003	INTERNATIONAL/NAVISTAR	5600I	CUMMINS N14 DIESEL	2002-2003
FREIGHTLINER	FL112	CUMMINS ISM DIESEL	2001-2001	INTERNATIONAL/NAVISTAR	5900I	CATERPILLAR C15 DIESEL	2004-2006
FREIGHTLINER	FL112	MERCEDES-BENZ MBE 4000 DIESEL	2003-2004	INTERNATIONAL/NAVISTAR	5900I	CUMMINS ISM DIESEL	2006-2006
FREIGHTLINER	FLC	CATERPILLAR 3306 DIESEL	1991-1992	INTERNATIONAL/NAVISTAR	5900I	CUMMINS ISX DIESEL	2007-2007
FREIGHTLINER	FLD	CATERPILLAR 3306 DIESEL	1991-1992	INTERNATIONAL/NAVISTAR	5900I	CUMMINS N14 DIESEL	2002-2003
FREIGHTLINER	FLD	CATERPILLAR C10 DIESEL	2002-2003	INTERNATIONAL/NAVISTAR	5900I	CUMMINS N14 DIESEL	2002-2003
FREIGHTLINER	FLD	CATERPILLAR C10 DIESEL	2001-2001	INTERNATIONAL/NAVISTAR	7400	CUMMINS ISM DIESEL	2005-2005
FREIGHTLINER	FLD	CATERPILLAR C10 DIESEL	2004-2004	INTERNATIONAL/NAVISTAR	7400	INTERNATIONAL/NAVISTAR 570 DIESEL	2006-2006
FREIGHTLINER	FLD	CATERPILLAR C10 DIESEL	2001-2003	INTERNATIONAL/NAVISTAR	7400	INTERNATIONAL/NAVISTAR 570 DIESEL	2006-2006
FREIGHTLINER	FLD	CATERPILLAR C10 DIESEL	2004-2004	INTERNATIONAL/NAVISTAR	7400	INTERNATIONAL/NAVISTAR 570 DIESEL	2006-2006
FREIGHTLINER	FLD	CATERPILLAR C12 DIESEL	2002-2003	INTERNATIONAL/NAVISTAR	7400	INTERNATIONAL/NAVISTAR 570 DIESEL	2006-2006
FREIGHTLINER	FLD	CATERPILLAR C12 DIESEL	2001-2001	INTERNATIONAL/NAVISTAR	7400	INTERNATIONAL/NAVISTAR DT570 DIESEL	2005-2007
FREIGHTLINER	FLD	CATERPILLAR C12 DIESEL	2004-2004	INTERNATIONAL/NAVISTAR	7400	INTERNATIONAL/NAVISTAR DT570 DIESEL	2005-2007
FREIGHTLINER	FLD	CATERPILLAR C12 DIESEL	2001-2003	INTERNATIONAL/NAVISTAR	7400	INTERNATIONAL/NAVISTAR DT570 DIESEL	2005-2007
FREIGHTLINER	FLD	CATERPILLAR C12 DIESEL	2004-2004	INTERNATIONAL/NAVISTAR	7400	INTERNATIONAL/NAVISTAR DT570 DIESEL	2005-2007
FREIGHTLINER	FLD	CATERPILLAR C15 DIESEL	2005-2006	INTERNATIONAL/NAVISTAR	7500	INTERNATIONAL/NAVISTAR DT570 DIESEL	2005-2005
FREIGHTLINER	FLD	CUMMINS ISX DIESEL	1999-2001	INTERNATIONAL/NAVISTAR	7500	INTERNATIONAL/NAVISTAR HT570	2006-2006
FREIGHTLINER	FLD	MERCEDES BENZ MBE 4000 Diesel	2009-2010	INTERNATIONAL/NAVISTAR	7500	INTERNATIONAL/NAVISTAR HT570 DIESEL	2005-2007
INTERNATIONAL/NAVISTAR	4400	INTERNATIONAL/NAVISTAR DT466	2006-2008	INTERNATIONAL/NAVISTAR	7600	CATERPILLAR C10 DIESEL	2004-2004
INTERNATIONAL/NAVISTAR	4700	INTERNATIONAL/NAVISTAR DT408 DIESEL	1995-1997	INTERNATIONAL/NAVISTAR	7600	CATERPILLAR C10 DIESEL	2002-2003
INTERNATIONAL/NAVISTAR	4800	INTERNATIONAL/NAVISTAR DT408 DIESEL	1995-1997	INTERNATIONAL/NAVISTAR	7600	CATERPILLAR C11 DIESEL	2004-2005
INTERNATIONAL/NAVISTAR	4900	INTERNATIONAL/NAVISTAR DT408 DIESEL	1995-1997	INTERNATIONAL/NAVISTAR	7600	CATERPILLAR C12 DIESEL	2004-2004
INTERNATIONAL/NAVISTAR	4900	INTERNATIONAL/NAVISTAR DT466	2002-2002	INTERNATIONAL/NAVISTAR	7600	CATERPILLAR C12 DIESEL	2002-2003
INTERNATIONAL/NAVISTAR	5500	CUMMINS ISM DIESEL	2005-2005	INTERNATIONAL/NAVISTAR	7600	CUMMINS ISM DIESEL	2003-2004
INTERNATIONAL/NAVISTAR	5500I	CATERPILLAR C10 DIESEL	2003-2004	INTERNATIONAL/NAVISTAR	7600	CUMMINS ISM DIESEL	2005-2007
INTERNATIONAL/NAVISTAR	5500I	CATERPILLAR C10 DIESEL	2003-2004	INTERNATIONAL/NAVISTAR	7600	CUMMINS ISM DIESEL	2007-2007
INTERNATIONAL/NAVISTAR	5500I	CATERPILLAR C10 DIESEL	2003-2004	INTERNATIONAL/NAVISTAR	7700	CATERPILLAR C11 DIESEL	2005-2005
INTERNATIONAL/NAVISTAR	5500I	CATERPILLAR C12 DIESEL	2003-2004	INTERNATIONAL/NAVISTAR	7700	CATERPILLAR C13 DIESEL	2005-2005



MASTER SERVICIO PESADO 2014

MANGUERAS

MARCA	MODELO	MOTOR	AÑOS	MARCA	MODELO	MOTOR	AÑOS
INTERNATIONAL/NAVISTAR	7700	CATERPILLAR C13 DIESEL	2005-2005	INTERNATIONAL/NAVISTAR	9400	CATERPILLAR C12 DIESEL	1996-1999
INTERNATIONAL/NAVISTAR	7700	CUMMINS ISM DIESEL	2005-2006	INTERNATIONAL/NAVISTAR	9400	CATERPILLAR C15 DIESEL	2005-2005
INTERNATIONAL/NAVISTAR	8100	CATERPILLAR C10 DIESEL	2000-2001	INTERNATIONAL/NAVISTAR	9400	CUMMINS ISX DIESEL	2005-2005
INTERNATIONAL/NAVISTAR	8100	CATERPILLAR C10 DIESEL	1998-2003	INTERNATIONAL/NAVISTAR	9400	DETROIT DIESEL SERIE 60	1999-1999
INTERNATIONAL/NAVISTAR	8100	CUMMINS N14 DIESEL	1995-1996	INTERNATIONAL/NAVISTAR	9400I	CATERPILLAR C10 DIESEL	2000-2002
INTERNATIONAL/NAVISTAR	8100	INTERNATIONAL/NAVISTAR 530 DIESEL	1999-2003	INTERNATIONAL/NAVISTAR	9400I	CATERPILLAR C12 DIESEL	2000-2003
INTERNATIONAL/NAVISTAR	8100	INTERNATIONAL/NAVISTAR 530 DIESEL	1999-2003	INTERNATIONAL/NAVISTAR	9400I	CATERPILLAR C15 DIESEL	2005-2007
INTERNATIONAL/NAVISTAR	8200	CUMMINS N14 DIESEL	1995-1996	INTERNATIONAL/NAVISTAR	9400I	CUMMINS ISM DIESEL	2007-2007
INTERNATIONAL/NAVISTAR	8200	DETROIT DIESEL 6 CIL, 11.1 L DIESEL	1995-1995	INTERNATIONAL/NAVISTAR	9400I	CUMMINS ISM DIESEL	2004-2006
INTERNATIONAL/NAVISTAR	8200	DETROIT DIESEL 6 CIL, 12.7 L DIESEL	1995-1995	INTERNATIONAL/NAVISTAR	9400I	CUMMINS ISX DIESEL	2000-2007
INTERNATIONAL/NAVISTAR	8600	CATERPILLAR C10 DIESEL	2003-2004	INTERNATIONAL/NAVISTAR	9400I	CUMMINS ISX DIESEL	2005-2007
INTERNATIONAL/NAVISTAR	8600	CATERPILLAR C11 DIESEL	2005-2006	INTERNATIONAL/NAVISTAR	9400I	CUMMINS ISX DIESEL	2003-2004
INTERNATIONAL/NAVISTAR	8600	CATERPILLAR C12 DIESEL	2003-2004	INTERNATIONAL/NAVISTAR	9400I	CUMMINS ISX DIESEL	2000-2002
INTERNATIONAL/NAVISTAR	8600	CATERPILLAR C13 DIESEL	2005-2006	INTERNATIONAL/NAVISTAR	9400I	DETROIT DIESEL 6 CIL, 12.7 L DIESEL	2001-2001
INTERNATIONAL/NAVISTAR	8600	CUMMINS ISM DIESEL	2003-2007	INTERNATIONAL/NAVISTAR	9400I	DETROIT DIESEL SERIE 60	2000-2000
INTERNATIONAL/NAVISTAR	9000	CUMMINS ISM DIESEL	2004-2004	INTERNATIONAL/NAVISTAR	9900	CATERPILLAR C10 DIESEL	1999-1999
INTERNATIONAL/NAVISTAR	9100	CATERPILLAR C10 DIESEL	1998-1999	INTERNATIONAL/NAVISTAR	9900	CATERPILLAR C12 DIESEL	1999-1999
INTERNATIONAL/NAVISTAR	9100	CATERPILLAR C12 DIESEL	1998-1999	INTERNATIONAL/NAVISTAR	9900	CATERPILLAR C15 DIESEL	2005-2005
INTERNATIONAL/NAVISTAR	9100	DETROIT DIESEL SERIE 60	1999-1999	INTERNATIONAL/NAVISTAR	9900	DETROIT DIESEL SERIE 60	1999-1999
INTERNATIONAL/NAVISTAR	9100I	CATERPILLAR C10 DIESEL	2000-2003	INTERNATIONAL/NAVISTAR	9900I	CATERPILLAR C10 DIESEL	2000-2002
INTERNATIONAL/NAVISTAR	9100I	CATERPILLAR C12 DIESEL	2000-2003	INTERNATIONAL/NAVISTAR	9900I	CATERPILLAR C12 DIESEL	2000-2003
INTERNATIONAL/NAVISTAR	9100I	CUMMINS ISX DIESEL	2001-2003	INTERNATIONAL/NAVISTAR	9900I	CATERPILLAR C15 DIESEL	2004-2008
INTERNATIONAL/NAVISTAR	9100I	DETROIT DIESEL 6 CIL, 12.7 L DIESEL	2001-2001	INTERNATIONAL/NAVISTAR	9900I	CUMMINS ISX DIESEL	2000-2002
INTERNATIONAL/NAVISTAR	9100I	DETROIT DIESEL SERIE 60	2000-2000	INTERNATIONAL/NAVISTAR	9900I	CUMMINS ISX DIESEL	2003-2008
INTERNATIONAL/NAVISTAR	9200	CATERPILLAR C10 DIESEL	1996-1999	INTERNATIONAL/NAVISTAR	9900I	CUMMINS ISX DIESEL	2000-2002
INTERNATIONAL/NAVISTAR	9200	CATERPILLAR C12 DIESEL	1996-1999	INTERNATIONAL/NAVISTAR	9900I	DETROIT DIESEL 6 CIL, 12.7 L DIESEL	2001-2001
INTERNATIONAL/NAVISTAR	9200	CUMMINS ISM DIESEL	2005-2005	INTERNATIONAL/NAVISTAR	9900I	DETROIT DIESEL SERIE 60	2000-2000
INTERNATIONAL/NAVISTAR	9200	CUMMINS ISX DIESEL	2005-2005	INTERNATIONAL/NAVISTAR	9900IX	CATERPILLAR C10 DIESEL	2000-2002
INTERNATIONAL/NAVISTAR	9200	DETROIT DIESEL SERIE 60	1999-1999	INTERNATIONAL/NAVISTAR	9900IX	CATERPILLAR C12 DIESEL	2000-2003
INTERNATIONAL/NAVISTAR	9200I	CATERPILLAR C10 DIESEL	2000-2003	INTERNATIONAL/NAVISTAR	9900IX	CATERPILLAR C15 DIESEL	2004-2007
INTERNATIONAL/NAVISTAR	9200I	CATERPILLAR C10 DIESEL	2004-2004	INTERNATIONAL/NAVISTAR	9900IX	CUMMINS ISX DIESEL	2000-2002
INTERNATIONAL/NAVISTAR	9200I	CATERPILLAR C12 DIESEL	2000-2003	INTERNATIONAL/NAVISTAR	9900IX	CUMMINS ISX DIESEL	2006-2006
INTERNATIONAL/NAVISTAR	9200I	CATERPILLAR C12 DIESEL	2004-2004	INTERNATIONAL/NAVISTAR	9900IX	CUMMINS ISX DIESEL	2000-2003
INTERNATIONAL/NAVISTAR	9200I	CATERPILLAR C13 DIESEL	2004-2008	INTERNATIONAL/NAVISTAR	9900IX	DETROIT DIESEL 6 CIL, 12.7 L DIESEL	2001-2001
INTERNATIONAL/NAVISTAR	9200I	CUMMINS ISM DIESEL	2003-2007	INTERNATIONAL/NAVISTAR	9900IX	DETROIT DIESEL SERIE 60	2000-2000
INTERNATIONAL/NAVISTAR	9200I	CUMMINS ISX DIESEL	2007-2013	INTERNATIONAL/NAVISTAR	CXT	INTERNATIONAL/NAVISTAR DT466	2005-2006
INTERNATIONAL/NAVISTAR	9200I	CUMMINS ISX DIESEL	2005-2013	INTERNATIONAL/NAVISTAR	CXT	INTERNATIONAL/NAVISTAR DT466	2005-2006
INTERNATIONAL/NAVISTAR	9200I	CUMMINS ISX DIESEL	2003-2004	INTERNATIONAL/NAVISTAR	CXT	INTERNATIONAL/NAVISTAR DT466	2005-2006
INTERNATIONAL/NAVISTAR	9200I	DETROIT DIESEL 6 CIL, 12.7 L DIESEL	2001-2001	INTERNATIONAL/NAVISTAR	MXT	INTERNATIONAL/NAVISTAR VT365 DIESEL	2007-2008
INTERNATIONAL/NAVISTAR	9200I	DETROIT DIESEL SERIE 60	2000-2000	INTERNATIONAL/NAVISTAR	PAYSTAR 5600I	CATERPILLAR C15 DIESEL	2008-2008
INTERNATIONAL/NAVISTAR	9300	CATERPILLAR C10 DIESEL	1996-1998	INTERNATIONAL/NAVISTAR	PAYSTAR 5900I	CUMMINS ISX DIESEL	2008-2008
INTERNATIONAL/NAVISTAR	9300	CATERPILLAR C12 DIESEL	1996-1998	INTERNATIONAL/NAVISTAR	PROSTAR SERIES	INTERNATIONAL/NAVISTAR MAXXFORCE 13 DIESEL	2008-2010
INTERNATIONAL/NAVISTAR	9400	CATERPILLAR C10 DIESEL	1996-1999	INTERNATIONAL/NAVISTAR	PROSTAR SERIES	INTERNATIONAL/NAVISTAR MAXXFORCE 13 DIESEL	2008-2010

MARCA	MODELO	MOTOR	AÑOS	MARCA	MODELO	MOTOR	AÑOS
INTERNATIONAL/NAVISTAR	TRANSTAR 8600	CUMMINS ISM DIESEL	2008-2008	STERLING	A-LINE	MERCEDES-BENZ MBE 4000 DIESEL	2004-2005
INTERNATIONAL/NAVISTAR	WORKSTAR 7300	INTERNATIONAL/NAVISTAR MAXXFORCE DT DIESEL	2008-2009	STERLING	L-LINE	CATERPILLAR C13 DIESEL	2007-2007
INTERNATIONAL/NAVISTAR	WORKSTAR 7400	INTERNATIONAL/NAVISTAR MAXXFORCE 10 DIESEL	2008-2008	STERLING	L-LINE	CATERPILLAR C13 DIESEL	2007-2007
INTERNATIONAL/NAVISTAR	WORKSTAR 7400	INTERNATIONAL/NAVISTAR MAXXFORCE 10 DIESEL	2008-2008	STERLING	L-LINE	CATERPILLAR C15 DIESEL	2007-2007
INTERNATIONAL/NAVISTAR	WORKSTAR 7400	INTERNATIONAL/NAVISTAR MAXXFORCE 10 DIESEL	2008-2008	STERLING	L-LINE	CATERPILLAR C15 DIESEL	2001-2002
INTERNATIONAL/NAVISTAR	WORKSTAR 7400	INTERNATIONAL/NAVISTAR MAXXFORCE 9 DIESEL	2008-2009	STERLING	L-LINE	CATERPILLAR C15 DIESEL	2008-2008
INTERNATIONAL/NAVISTAR	WORKSTAR 7500	INTERNATIONAL/NAVISTAR MAXXFORCE 10 DIESEL	2008-2008	STERLING	L-LINE	CATERPILLAR C15 DIESEL	2005-2007
INTERNATIONAL/NAVISTAR	WORKSTAR 7600	CUMMINS ISM DIESEL	2008-2009	STERLING	L-LINE	CATERPILLAR C16 DIESEL	2001-2001
KENWORTH	T2000	CATERPILLAR 3406 DIESEL	2000-2000	STERLING	L-LINE	CATERPILLAR C9 DIESEL	2004-2004
KENWORTH	T300	CATERPILLAR 3126 DIESEL	1996-2003	STERLING	L-LINE	CUMMINS ISB DIESEL	2000-2000
KENWORTH	T660	CATERPILLAR C15 DIESEL	2007-2013	STERLING	L-LINE	CUMMINS ISC DIESEL	2000-2003
KENWORTH	T660	CUMMINS ISX DIESEL	2007-2014	STERLING	L-LINE	DETROIT DIESEL 6 CIL, 11.1 L DIESEL	2002-2002
KENWORTH	T800	CATERPILLAR C13 DIESEL	2008-2014	STERLING	L-LINE	DETROIT DIESEL 6 CIL, 11.1 L DIESEL	2002-2002
KENWORTH	T800	CATERPILLAR C13 DIESEL	2008-2014	STERLING	L-LINE	DETROIT DIESEL 6 CIL, 12.7 L DIESEL	2002-2003
KENWORTH	T800	CUMMINS ISX DIESEL	2008-2014	STERLING	L-LINE	DETROIT DIESEL 6 CIL, 12.7 L DIESEL	2003-2004
KENWORTH	T800	CUMMINS ISX DIESEL	2008-2014	STERLING	L-LINE	DETROIT DIESEL 6 CIL, 12.7 L DIESEL	2002-2002
MACK	CH SERIES	MACK 6 CIL, 12.0 L DIESEL	2001-2002	STERLING	L-LINE	DETROIT DIESEL 6 CIL, 14.0 L DIESEL	2003-2003
MACK	CH SERIES	MACK AC DIESEL	2003-2006	STERLING	L-LINE	DETROIT DIESEL 6 CIL, 14.0 L DIESEL	2003-2004
MACK	CHN SERIES	MACK AC DIESEL	2006-2007	STERLING	L-LINE	DETROIT DIESEL SERIE 60	2002-2003
MACK	CHU SERIES	MACK MP8 DIESEL	2008-2010	STERLING	L-LINE	DETROIT DIESEL SERIE 60	2003-2005
MACK	CTP SERIES	MACK MP7 DIESEL	2007-2007	STERLING	L-LINE	DETROIT DIESEL SERIE 60	2002-2002
MACK	CV SERIES	MACK AI DIESEL	2005-2007	STERLING	L-LINE	MERCEDES-BENZ MBE 4000 DIESEL	2003-2005
MACK	CV SERIES	MACK AMI DIESEL	2004-2005	STERLING	L-LINE	MERCEDES-BENZ MBE 4000 DIESEL	2007-2007
MACK	CXP SERIES	MACK MP7 DIESEL	2006-2006	STERLING	SILVER STAR	CATERPILLAR C15 DIESEL	2000-2000
MACK	CXP SERIES	MACK MP7 DIESEL	2006-2006	VOLVO	VNL	CUMMINS ISM DIESEL	2001-2001
MACK	DM SERIES	MACK 6 CIL, 12.0 L DIESEL	2001-2001	VOLVO	VNL	CUMMINS ISM DIESEL	2001-2001
MACK	GRANITE	MACK MP8 DIESEL	2011-2013	VOLVO	VNL	VOLVO D16 DIESEL	2008-2013
STERLING	ACTERRA	CATERPILLAR C13 DIESEL	2004-2004	VOLVO	VNM	VOLVO D16 DIESEL	2008-2013
STERLING	ACTERRA	CATERPILLAR C7 DIESEL	2004-2004	VOLVO	WCA SERIES	CUMMINS M11 DIESEL	1996-1997
STERLING	ACTERRA	CATERPILLAR C7 DIESEL	2004-2004	VOLVO	WIA SERIES	VOLVO VE D12 DIESEL	1996-1996
STERLING	A-LINE	CATERPILLAR C13 DIESEL	2004-2004	 <div style="background-color: red; color: white; padding: 5px; display: inline-block;"> 21875 MANG. INFERIOR </div>			
STERLING	A-LINE	CATERPILLAR C15 DIESEL	2000-2001				
STERLING	A-LINE	CATERPILLAR C16 DIESEL	2000-2000	 <div style="background-color: red; color: white; padding: 5px; display: inline-block;"> 21845 MANGUERA INFERIOR </div>			
STERLING	A-LINE	CATERPILLAR C9 DIESEL	2004-2004				
STERLING	A-LINE	DETROIT DIESEL 6 CIL, 11.1 L DIESEL	2002-2002	FORD	F-450 SUPER DUTY	V8, 7.5 L	1997-1997
STERLING	A-LINE	DETROIT DIESEL 6 CIL, 11.1 L DIESEL	2002-2002				
STERLING	A-LINE	DETROIT DIESEL 6 CIL, 12.7 L DIESEL	2002-2002				
STERLING	A-LINE	DETROIT DIESEL 6 CIL, 12.7 L DIESEL	2004-2004	FORD	F-600	FORD 6 CIL, 6.6 L DIESEL	1991-1993
STERLING	A-LINE	DETROIT DIESEL 6 CIL, 12.7 L DIESEL	2002-2002	FORD	F-600	FORD 6 CIL, 7.8 L DIESEL	1991-1991
STERLING	A-LINE	DETROIT DIESEL 6 CIL, 14.0 L DIESEL	2004-2004				
STERLING	A-LINE	DETROIT DIESEL SERIE 60	2002-2002				
STERLING	A-LINE	DETROIT DIESEL SERIE 60	2004-2004				
STERLING	A-LINE	DETROIT DIESEL SERIE 60	2002-2002				

MARCA	MODELO	MOTOR	AÑOS	MARCA	MODELO	MOTOR	AÑOS								
 <p>21842 MANGUERA INFERIOR</p>				 <p>21571 MANGUERA SUPERIOR</p>											
								DINA	S-500	INTERNATIONAL/NAVISTAR DT466 DIESEL	1990-1997	FORD	F-650 SUPER DUTY	CATERPILLAR C7 DIESEL	2004-2006
								INTERNATIONAL/NAVISTAR	4700	INTERNATIONAL/NAVISTAR DT466	1995-1999	FORD	F-750 SUPER DUTY	CATERPILLAR C7 DIESEL	2004-2006
								INTERNATIONAL/NAVISTAR	4800	INTERNATIONAL/NAVISTAR DT466	1995-2003	STERLING	ACTERRA	CUMMINS ISC DIESEL	2005-2005
								INTERNATIONAL/NAVISTAR	4800	INTERNATIONAL/NAVISTAR DT466	1995-2003	STERLING	ACTERRA	MERCEDES-BENZ MBE 900 DIESEL	2001-2005
								INTERNATIONAL/NAVISTAR	4900	INTERNATIONAL/NAVISTAR DT466	1995-1996	STERLING	ACTERRA	MERCEDES-BENZ MBE 900 DIESEL	2001-2002
								INTERNATIONAL/NAVISTAR	4900	INTERNATIONAL/NAVISTAR DT466	1995-1999	STERLING	L-LINE	CATERPILLAR 3126 DIESEL	2002-2004
								INTERNATIONAL/NAVISTAR	7100	INTERNATIONAL/NAVISTAR DT466	1995-1995	STERLING	L-LINE	CATERPILLAR 3126 DIESEL	2002-2004
								INTERNATIONAL/NAVISTAR	7100	INTERNATIONAL/NAVISTAR DT466	1995-1995				
 <p>21765 MANGUERA SUPERIOR</p>				 <p>21559 MANGUERA INFERIOR</p>											
								DINA	S-400	INTERNATIONAL/NAVISTAR DT360 DIESEL	1990-1997	STERLING	ACTERRA	MERCEDES-BENZ MBE 900 DIESEL	2007-2007
								DINA	S-500	INTERNATIONAL/NAVISTAR DT360 DIESEL	1990-1997				
								DINA	S-500	INTERNATIONAL/NAVISTAR DT466 DIESEL	1990-1997				
								INTERNATIONAL/NAVISTAR	4700	INTERNATIONAL/NAVISTAR DT466	1995-1999				
								INTERNATIONAL/NAVISTAR	4800	INTERNATIONAL/NAVISTAR DT466	1995-2003				
								INTERNATIONAL/NAVISTAR	4900	INTERNATIONAL/NAVISTAR DT466	1995-1999				
								INTERNATIONAL/NAVISTAR	7100	INTERNATIONAL/NAVISTAR DT466	1995-1995				
 <p>21492 MANGUERA SUPERIOR</p>				 <p>21488 MANGUERA DE ENFRIAMIENTO</p>											
								STERLING	A-LINE	CATERPILLAR C9 DIESEL	2004-2004				
								STERLING	L-LINE	CATERPILLAR C9 DIESEL	2004-2004				
 <p>21753 MANGUERA SUPERIOR</p>				 <p>21472 MANGUERA INFERIOR</p>											
								CHEVROLET	S-10	4 CIL, 2.2 L	1994-1994				
 <p>21752 MANGUERA SUPERIOR</p>				 <p>21668 MANG. SUPERIOR</p>											
								CHEVROLET	S-10	4 CIL, 2.2 L	1995-1997				
 <p>21591 MANGUERA INFERIOR</p>				 <p>21488 MANGUERA DE ENFRIAMIENTO</p>											
								FORD	F-450 SUPER DUTY	V8, 7.5 L	1997-1997	FREIGHTLINER	CENTURY CLASS	DETROIT DIESEL 6 CIL, 11.1 L DIESEL	1998-1998
												FREIGHTLINER	CENTURY CLASS	DETROIT DIESEL 6 CIL, 12.7 L DIESEL	1998-1998
												FREIGHTLINER	CENTURY CLASS	DETROIT DIESEL SERIE 60	1998-1998
												FREIGHTLINER	FLC	CATERPILLAR 3306 DIESEL	1991-1992
												FREIGHTLINER	FLC	DETROIT DIESEL 6 CIL, 11.1 L DIESEL	1991-1998
												FREIGHTLINER	FLC	DETROIT DIESEL 6 CIL, 12.7 L DIESEL	1991-1998
												FREIGHTLINER	FLC	DETROIT DIESEL SERIE 60	1990-1997
												FREIGHTLINER	FLD	CATERPILLAR 3306 DIESEL	1991-1992
												FREIGHTLINER	FLD	DETROIT DIESEL 6 CIL, 11.1 L DIESEL	1991-1998
												FREIGHTLINER	FLD	DETROIT DIESEL 6 CIL, 12.7 L DIESEL	1991-1998

MARCA	MODELO	MOTOR	AÑOS	MARCA	MODELO	MOTOR	AÑOS
FREIGHTLINER	FLD	DETROIT DIESEL SERIE 60	1990-1998	FORD	F-600	FORD V8, 6.1 L	1991-1991
		21457 MANGUERA DE PASO		FORD	F-600	FORD V8, 7.0 L	1991-1994
INTERNATIONAL/NAVISTAR	3800	INTERNATIONAL/NAVISTAR DT466	1998-1998			21194 MANGUERA SUPERIOR	
		21400 MANGUERA INFERIOR		FREIGHTLINER	CLASSIC	CATERPILLAR C15 DIESEL	2004-2005
INTERNATIONAL/NAVISTAR	3800	INTERNATIONAL/NAVISTAR DT466	1998-1998	FREIGHTLINER	FL112	CATERPILLAR C10 DIESEL	1999-1999
		21378 MANGUERA SUPERIOR		FREIGHTLINER	FL112	CATERPILLAR C12 DIESEL	1999-1999
FREIGHTLINER	ARGOSY	CATERPILLAR 3406 DIESEL	1999-2000	FREIGHTLINER	FLD	CATERPILLAR C10 DIESEL	1997-1997
FREIGHTLINER	ARGOSY	CATERPILLAR C15 DIESEL	2001-2004	FREIGHTLINER	FLD	CATERPILLAR C10 DIESEL	1997-1997
		21372 MANGUERA SUPERIOR		FREIGHTLINER	FLD	CATERPILLAR C12 DIESEL	1996-1997
FREIGHTLINER	BUSINESS CLASS M2	MERCEDES-BENZ MBE 900 DIESEL	2002-2007	FREIGHTLINER	FLD	CATERPILLAR C12 DIESEL	1996-1997
KENWORTH	K100	CUMMINS C Series 8.3 L DIESEL	1992-1993	INTERNATIONAL/NAVISTAR	7300	INTERNATIONAL/NAVISTAR DT466	2006-2006
STERLING	ACTERRA	MERCEDES-BENZ MBE 900 DIESEL	2005-2006	INTERNATIONAL/NAVISTAR	7400	INTERNATIONAL/NAVISTAR DT466	2005-2007
		21150 MANGUERA DE PASO		INTERNATIONAL/NAVISTAR	8100	CUMMINS ISM DIESEL	2002-2003
INTERNATIONAL/NAVISTAR	8100	CUMMINS L10 DIESEL	1995-1996	KENWORTH	T300	CATERPILLAR C7 DIESEL	2005-2007
		21335 MANGUERA SUPERIOR		MACK	CV SERIES	MACK 6 CIL, 12.0 L DIESEL	2001-2002
INTERNATIONAL/NAVISTAR	55001	CATERPILLAR C10 DIESEL	2001-2002	MACK	CV SERIES	MACK AMI DIESEL	2003-2003
INTERNATIONAL/NAVISTAR	55001	CATERPILLAR C12 DIESEL	2000-2002			21135 MANGUERA INFERIOR	
INTERNATIONAL/NAVISTAR	56001	CATERPILLAR C10 DIESEL	2001-2002	FREIGHTLINER	CLASSIC	DETROIT DIESEL SERIE 60	2005-2005
INTERNATIONAL/NAVISTAR	56001	CATERPILLAR C12 DIESEL	2000-2002	FREIGHTLINER	CLASSIC XL	DETROIT DIESEL 6 CIL, 12.7 L DIESEL	2005-2005
INTERNATIONAL/NAVISTAR	59001	CATERPILLAR C10 DIESEL	2001-2002			21302 MANGUERA INFERIOR	
INTERNATIONAL/NAVISTAR	59001	CATERPILLAR C12 DIESEL	2000-2002	INTERNATIONAL/NAVISTAR	CE	INTERNATIONAL/NAVISTAR MAXXFORCE DT DIESEL	2009-2010
INTERNATIONAL/NAVISTAR	59001	CATERPILLAR C10 DIESEL	2001-2002	INTERNATIONAL/NAVISTAR	DURASTAR 4300	INTERNATIONAL/NAVISTAR MAXXFORCE DT DIESEL	2008-2012
INTERNATIONAL/NAVISTAR	59001	CATERPILLAR C12 DIESEL	2000-2002	INTERNATIONAL/NAVISTAR	DURASTAR 4400	INTERNATIONAL/NAVISTAR MAXXFORCE DT DIESEL	2008-2011
		21249 MANGUERA INFERIOR		FREIGHTLINER	BUSINESS CLASS M2	CUMMINS ISC DIESEL	2006-2006
INTERNATIONAL/NAVISTAR	CE	INTERNATIONAL/NAVISTAR MAXXFORCE DT DIESEL	2009-2010	FREIGHTLINER	CENTURY CLASS	CATERPILLAR C11 DIESEL	2006-2006
INTERNATIONAL/NAVISTAR	DURASTAR 4300	INTERNATIONAL/NAVISTAR MAXXFORCE DT DIESEL	2008-2012	FREIGHTLINER	CENTURY CLASS	CATERPILLAR C13 DIESEL	2006-2006
INTERNATIONAL/NAVISTAR	DURASTAR 4400	INTERNATIONAL/NAVISTAR MAXXFORCE DT DIESEL	2008-2011	FREIGHTLINER	CENTURY CLASS	CUMMINS ISX DIESEL	2000-2000
		21150 MANGUERA DE PASO		FREIGHTLINER	CLASSIC	DETROIT DIESEL 6 CIL, 12.7 L DIESEL	2005-2007
FREIGHTLINER	CLASSIC	DETROIT DIESEL SERIE 60	2005-2005	FREIGHTLINER	CLASSIC	DETROIT DIESEL 6 CIL, 14.0 L DIESEL	2005-2007
FREIGHTLINER	CLASSIC XL	DETROIT DIESEL 6 CIL, 12.7 L DIESEL	2005-2005	FREIGHTLINER	CLASSIC	DETROIT DIESEL SERIE 60	2005-2005
		21135 MANGUERA INFERIOR		FREIGHTLINER	CLASSIC XL	DETROIT DIESEL 6 CIL, 12.7 L DIESEL	2005-2007
FREIGHTLINER	BUSINESS CLASS M2	CUMMINS ISC DIESEL	2006-2006	FREIGHTLINER	CLASSIC XL	DETROIT DIESEL 6 CIL, 14.0 L DIESEL	2005-2007
FREIGHTLINER	CENTURY CLASS	CATERPILLAR C11 DIESEL	2006-2006	FREIGHTLINER	COLUMBIA	DETROIT DIESEL 6 CIL, 12.7 L DIESEL	2004-2006
FREIGHTLINER	CENTURY CLASS	CATERPILLAR C13 DIESEL	2006-2006	FREIGHTLINER	COLUMBIA	DETROIT DIESEL 6 CIL, 14.0 L DIESEL	2004-2006
FREIGHTLINER	CENTURY CLASS	CUMMINS ISX DIESEL	2000-2000	FREIGHTLINER	COLUMBIA	DETROIT DIESEL SERIE 60	2004-2006
FREIGHTLINER	CLASSIC	DETROIT DIESEL 6 CIL, 12.7 L DIESEL	2005-2007	FREIGHTLINER	CORONADO	DETROIT DIESEL 6 CIL, 12.7 L DIESEL	2004-2008
FREIGHTLINER	CLASSIC	DETROIT DIESEL 6 CIL, 14.0 L DIESEL	2005-2007	FREIGHTLINER	CORONADO	DETROIT DIESEL 6 CIL, 14.0 L DIESEL	2004-2010
FREIGHTLINER	CLASSIC	DETROIT DIESEL SERIE 60	2005-2005	FREIGHTLINER	CORONADO	DETROIT DIESEL SERIE 60	2004-2006
FREIGHTLINER	CLASSIC XL	DETROIT DIESEL 6 CIL, 12.7 L DIESEL	2005-2007				



MASTER SERVICIO PESADO 2014



MANGUERAS

MARCA	MODELO	MOTOR	AÑOS	MARCA	MODELO	MOTOR	AÑOS
FREIGHTLINER	FLD	CATERPILLAR C11 DIESEL	2005-2007	INTERNATIONAL/NAVISTAR	5900I	CUMMINS ISX DIESEL	2003-2007
FREIGHTLINER	FLD	CATERPILLAR C13 DIESEL	2005-2007	INTERNATIONAL/NAVISTAR	5900I	CUMMINS ISX DIESEL	2003-2007
FREIGHTLINER	FLD	DETROIT DIESEL 6 CIL, 12.7 L DIESEL	2005-2008	INTERNATIONAL/NAVISTAR	5900I	CUMMINS ISX DIESEL	2003-2006
FREIGHTLINER	FLD	DETROIT DIESEL 6 CIL, 14.0 L DIESEL	2005-2007	INTERNATIONAL/NAVISTAR	7400	CUMMINS ISM DIESEL	2005-2005
FREIGHTLINER	FLD	DETROIT DIESEL SERIE 60	2006-2006	INTERNATIONAL/NAVISTAR	7400	INTERNATIONAL/NAVISTAR 570 DIESEL	2006-2006
INTERNATIONAL/NAVISTAR	5000	CATERPILLAR C10 DIESEL	1998-2000	INTERNATIONAL/NAVISTAR	7400	INTERNATIONAL/NAVISTAR DT466	2005-2007
INTERNATIONAL/NAVISTAR	5000	CATERPILLAR C12 DIESEL	2000-2000	INTERNATIONAL/NAVISTAR	7400	INTERNATIONAL/NAVISTAR DT466	2005-2007
INTERNATIONAL/NAVISTAR	5000	CATERPILLAR C12 DIESEL	1998-1999	INTERNATIONAL/NAVISTAR	7400	INTERNATIONAL/NAVISTAR DT570 DIESEL	2005-2007
INTERNATIONAL/NAVISTAR	5000	CUMMINS ISM DIESEL	1999-2000	INTERNATIONAL/NAVISTAR	7600	CATERPILLAR C10 DIESEL	2002-2004
INTERNATIONAL/NAVISTAR	5000	CUMMINS M11 DIESEL	1999-1999	INTERNATIONAL/NAVISTAR	7600	CATERPILLAR C12 DIESEL	2002-2004
INTERNATIONAL/NAVISTAR	5500	CUMMINS ISM DIESEL	2005-2005	INTERNATIONAL/NAVISTAR	7600	CUMMINS ISM DIESEL	2003-2004
INTERNATIONAL/NAVISTAR	5500I	CATERPILLAR C10 DIESEL	2000-2000	INTERNATIONAL/NAVISTAR	7600	CUMMINS ISM DIESEL	2005-2007
INTERNATIONAL/NAVISTAR	5500I	CATERPILLAR C13 DIESEL	2005-2007	INTERNATIONAL/NAVISTAR	7700	CUMMINS ISM DIESEL	2005-2006
INTERNATIONAL/NAVISTAR	5500I	CATERPILLAR C13 DIESEL	2005-2007	INTERNATIONAL/NAVISTAR	8100	CATERPILLAR 3176 DIESEL	1996-1997
INTERNATIONAL/NAVISTAR	5500I	CUMMINS ISM DIESEL	2006-2006	INTERNATIONAL/NAVISTAR	8100	CATERPILLAR 3176 DIESEL	1996-1997
INTERNATIONAL/NAVISTAR	5500I	CUMMINS ISM DIESEL	2006-2006	INTERNATIONAL/NAVISTAR	8100	CATERPILLAR 3406 DIESEL	1998-1998
INTERNATIONAL/NAVISTAR	5500I	CUMMINS ISM DIESEL	2002-2006	INTERNATIONAL/NAVISTAR	8100	CATERPILLAR C10 DIESEL	1998-2003
INTERNATIONAL/NAVISTAR	5500I	CUMMINS ISX DIESEL	2006-2006	INTERNATIONAL/NAVISTAR	8100	CATERPILLAR C10 DIESEL	1998-2003
INTERNATIONAL/NAVISTAR	5500I	CUMMINS ISX DIESEL	2007-2007	INTERNATIONAL/NAVISTAR	8100	CUMMINS ISM DIESEL	1998-2001
INTERNATIONAL/NAVISTAR	5500I	CUMMINS ISX DIESEL	2003-2007	INTERNATIONAL/NAVISTAR	8100	CUMMINS ISM DIESEL	1998-1998
INTERNATIONAL/NAVISTAR	5500I	CUMMINS ISX DIESEL	2003-2006	INTERNATIONAL/NAVISTAR	8100	CUMMINS ISM DIESEL	2000-2003
INTERNATIONAL/NAVISTAR	5600	CUMMINS ISM DIESEL	2005-2005	INTERNATIONAL/NAVISTAR	8100	CUMMINS M11 DIESEL	1995-1997
INTERNATIONAL/NAVISTAR	5600	CUMMINS ISX DIESEL	2005-2005	INTERNATIONAL/NAVISTAR	8100	CUMMINS M11 DIESEL	1995-1997
INTERNATIONAL/NAVISTAR	5600	CUMMINS ISX DIESEL	2005-2005	INTERNATIONAL/NAVISTAR	8100	INTERNATIONAL/NAVISTAR 530 DIESEL	1999-2003
INTERNATIONAL/NAVISTAR	5600I	CATERPILLAR C10 DIESEL	2000-2000	INTERNATIONAL/NAVISTAR	8200	CUMMINS ISM DIESEL	1998-1998
INTERNATIONAL/NAVISTAR	5600I	CATERPILLAR C13 DIESEL	2005-2005	INTERNATIONAL/NAVISTAR	8200	CUMMINS ISM DIESEL	1998-1998
INTERNATIONAL/NAVISTAR	5600I	CATERPILLAR C13 DIESEL	2005-2005	INTERNATIONAL/NAVISTAR	8200	CUMMINS M11 DIESEL	1995-1997
INTERNATIONAL/NAVISTAR	5600I	CATERPILLAR C13 DIESEL	2005-2005	INTERNATIONAL/NAVISTAR	8200	CUMMINS M11 DIESEL	1995-1997
INTERNATIONAL/NAVISTAR	5600I	CUMMINS ISM DIESEL	2007-2007	INTERNATIONAL/NAVISTAR	8600	CATERPILLAR C10 DIESEL	2003-2003
INTERNATIONAL/NAVISTAR	5600I	CUMMINS ISM DIESEL	2002-2006	INTERNATIONAL/NAVISTAR	8600	CATERPILLAR C10 DIESEL	2003-2004
INTERNATIONAL/NAVISTAR	5600I	CUMMINS ISX DIESEL	2006-2007	INTERNATIONAL/NAVISTAR	8600	CATERPILLAR C11 DIESEL	2007-2007
INTERNATIONAL/NAVISTAR	5600I	CUMMINS ISX DIESEL	2005-2006	INTERNATIONAL/NAVISTAR	8600	CATERPILLAR C11 DIESEL	2007-2007
INTERNATIONAL/NAVISTAR	5600I	CUMMINS ISX DIESEL	2005-2006	INTERNATIONAL/NAVISTAR	8600	CATERPILLAR C11 DIESEL	2004-2006
INTERNATIONAL/NAVISTAR	5900I	CATERPILLAR C10 DIESEL	2003-2003	INTERNATIONAL/NAVISTAR	8600	CATERPILLAR C11 DIESEL	2004-2007
INTERNATIONAL/NAVISTAR	5900I	CATERPILLAR C10 DIESEL	2003-2003	INTERNATIONAL/NAVISTAR	8600	CATERPILLAR C12 DIESEL	2003-2003
INTERNATIONAL/NAVISTAR	5900I	CATERPILLAR C10 DIESEL	2003-2003	INTERNATIONAL/NAVISTAR	8600	CATERPILLAR C12 DIESEL	2003-2004
INTERNATIONAL/NAVISTAR	5900I	CATERPILLAR C10 DIESEL	2000-2000	INTERNATIONAL/NAVISTAR	8600	CATERPILLAR C13 DIESEL	2007-2007
INTERNATIONAL/NAVISTAR	5900I	CATERPILLAR C12 DIESEL	2003-2004	INTERNATIONAL/NAVISTAR	8600	CATERPILLAR C13 DIESEL	2007-2007
INTERNATIONAL/NAVISTAR	5900I	CATERPILLAR C12 DIESEL	2003-2004	INTERNATIONAL/NAVISTAR	8600	CATERPILLAR C13 DIESEL	2004-2006
INTERNATIONAL/NAVISTAR	5900I	CATERPILLAR C12 DIESEL	2003-2004	INTERNATIONAL/NAVISTAR	8600	CATERPILLAR C13 DIESEL	2004-2007
INTERNATIONAL/NAVISTAR	5900I	CATERPILLAR C15 DIESEL	2004-2006	INTERNATIONAL/NAVISTAR	9000	CUMMINS ISM DIESEL	2004-2004
INTERNATIONAL/NAVISTAR	5900I	CATERPILLAR C15 DIESEL	2004-2006	INTERNATIONAL/NAVISTAR	9000	CUMMINS ISX DIESEL	2004-2004
INTERNATIONAL/NAVISTAR	5900I	CUMMINS ISM DIESEL	2001-2006	INTERNATIONAL/NAVISTAR	9000	CUMMINS ISX DIESEL	2004-2004

MARCA	MODELO	MOTOR	AÑOS	MARCA	MODELO	MOTOR	AÑOS				
INTERNATIONAL/NAVISTAR	CXT	INTERNATIONAL/NAVISTAR DT466	2005-2006	STERLING	L-LINE	CATERPILLAR C15 DIESEL	2005-2005				
INTERNATIONAL/NAVISTAR	DURASTAR 4300	INTERNATIONAL/NAVISTAR MAXXFORCE 7 DIESEL	2008-2008	STERLING	L-LINE	CATERPILLAR C15 DIESEL	2005-2005				
INTERNATIONAL/NAVISTAR	PAYSTAR	CATERPILLAR C10 DIESEL	2000-2000	STERLING	L-LINE	CATERPILLAR C15 DIESEL	2001-2002				
INTERNATIONAL/NAVISTAR	PAYSTAR	CATERPILLAR C12 DIESEL	2000-2000	STERLING	L-LINE	CATERPILLAR C16 DIESEL	2001-2001				
INTERNATIONAL/NAVISTAR	PAYSTAR	CUMMINS M11 DIESEL	1999-1999	STERLING	L-LINE	CUMMINS ISX DIESEL	2001-2001				
INTERNATIONAL/NAVISTAR	PAYSTAR 5500i	CUMMINS ISX DIESEL	2008-2008	STERLING	L-LINE	CUMMINS ISX DIESEL	2001-2001				
INTERNATIONAL/NAVISTAR	PAYSTAR 5500i	CUMMINS ISX DIESEL	2008-2008	STERLING	L-LINE	CUMMINS N14 DIESEL	2001-2002				
INTERNATIONAL/NAVISTAR	PAYSTAR 5600i	CATERPILLAR C15 DIESEL	2008-2008	STERLING	L-LINE	CUMMINS N14 DIESEL	2000-2000				
INTERNATIONAL/NAVISTAR	PAYSTAR 5600i	CATERPILLAR C15 DIESEL	2008-2008	STERLING	L-LINE	CUMMINS N14 DIESEL	2001-2003				
INTERNATIONAL/NAVISTAR	PAYSTAR 5900i	CUMMINS ISX DIESEL	2008-2008	STERLING	L-LINE	CUMMINS N14 DIESEL	2000-2000				
INTERNATIONAL/NAVISTAR	PAYSTAR 5900i	CUMMINS ISX DIESEL	2008-2008	STERLING	L-LINE	CUMMINS SIGNATURE 600 DIESEL	2001-2001				
INTERNATIONAL/NAVISTAR	PROSTAR SERIES	INTERNATIONAL/NAVISTAR MAXXFORCE 13 DIESEL	2008-2010	STERLING	L-LINE	CUMMINS SIGNATURE 600 DIESEL	2001-2001				
INTERNATIONAL/NAVISTAR	TRANSTAR 8600	CUMMINS ISM DIESEL	2008-2008	STERLING	L-LINE	DETROIT DIESEL 6 CIL, 12.7 L DIESEL	2006-2007				
INTERNATIONAL/NAVISTAR	TRANSTAR 8600	CUMMINS ISM DIESEL	2008-2008	STERLING	L-LINE	DETROIT DIESEL 6 CIL, 14.0 L DIESEL	2006-2007				
INTERNATIONAL/NAVISTAR	WORKSTAR 7300	INTERNATIONAL/NAVISTAR MAXXFORCE DT DIESEL	2008-2009	STERLING	L-LINE	MERCEDES-BENZ MBE 4000 DIESEL	2007-2007				
INTERNATIONAL/NAVISTAR	WORKSTAR 7300	INTERNATIONAL/NAVISTAR MAXXFORCE DT DIESEL	2008-2009	STERLING	SILVER STAR	CUMMINS SIGNATURE 600 DIESEL	2001-2001				
INTERNATIONAL/NAVISTAR	WORKSTAR 7400	INTERNATIONAL/NAVISTAR MAXXFORCE 10 DIESEL	2008-2008	 <p>21128 MANGUERA INFERIOR</p>							
INTERNATIONAL/NAVISTAR	WORKSTAR 7400	INTERNATIONAL/NAVISTAR MAXXFORCE 9 DIESEL	2010-2012								
INTERNATIONAL/NAVISTAR	WORKSTAR 7400	INTERNATIONAL/NAVISTAR MAXXFORCE 9 DIESEL	2008-2012								
INTERNATIONAL/NAVISTAR	WORKSTAR 7500	INTERNATIONAL/NAVISTAR MAXXFORCE 10 DIESEL	2008-2008								
INTERNATIONAL/NAVISTAR	WORKSTAR 7500	INTERNATIONAL/NAVISTAR MAXXFORCE 10 DIESEL	2008-2008								
INTERNATIONAL/NAVISTAR	WORKSTAR 7600	CUMMINS ISM DIESEL	2008-2009								
KENWORTH	T660	CATERPILLAR C15 DIESEL	2007-2013					FREIGHTLINER	BUSINESS CLASS M2	CATERPILLAR 3126 DIESEL	2007-2007
KENWORTH	W900	CATERPILLAR C15 DIESEL	2008-2010					FREIGHTLINER	BUSINESS CLASS M2	CATERPILLAR 3126 DIESEL	2007-2007
KENWORTH	W900	CUMMINS ISX DIESEL	2010-2013					FREIGHTLINER	BUSINESS CLASS M2	CATERPILLAR C7 DIESEL	2006-2007
KENWORTH	W900	CUMMINS ISX DIESEL	2010-2013					FREIGHTLINER	BUSINESS CLASS M2	CATERPILLAR C7 DIESEL	2006-2007
STERLING	ACTERRA	CATERPILLAR 3126 DIESEL	2001-2004	 <p>21116 MANGUERA INFERIOR</p>							
STERLING	ACTERRA	MERCEDES-BENZ MBE 900 DIESEL	2001-2004								
STERLING	ACTERRA	MERCEDES-BENZ MBE 900 DIESEL	2001-2004								
STERLING	A-LINE	CATERPILLAR C10 DIESEL	2000-2001					VOLVO	XPEDITOR	CATERPILLAR 3306 DIESEL	1996-1996
STERLING	A-LINE	CATERPILLAR C12 DIESEL	2000-2001					 <p>21115 MANGUERA INFERIOR</p>			
STERLING	A-LINE	CATERPILLAR C15 DIESEL	2000-2001								
STERLING	A-LINE	CATERPILLAR C16 DIESEL	2000-2000								
STERLING	A-LINE	CUMMINS N14 DIESEL	2001-2002								
STERLING	A-LINE	CUMMINS N14 DIESEL	2000-2000								
STERLING	A-LINE	CUMMINS N14 DIESEL	2001-2003								
STERLING	A-LINE	CUMMINS N14 DIESEL	2000-2000								
STERLING	A-LINE	DETROIT DIESEL 6 CIL, 12.7 L DIESEL	2006-2006								
STERLING	A-LINE	DETROIT DIESEL 6 CIL, 14.0 L DIESEL	2006-2006								
STERLING	L-LINE	CATERPILLAR 3126 DIESEL	2000-2001	DINA	S-500	INTERNATIONAL/NAVISTAR DT466 DIESEL	1990-1997				
STERLING	L-LINE	CATERPILLAR C10 DIESEL	2000-2002	FREIGHTLINER	CLASSIC	DETROIT DIESEL 6 CIL, 12.7 L DIESEL	2005-2007				
STERLING	L-LINE	CATERPILLAR C12 DIESEL	2000-2002	FREIGHTLINER	CLASSIC	DETROIT DIESEL 6 CIL, 14.0 L DIESEL	2005-2007				
STERLING	L-LINE	CATERPILLAR C13 DIESEL	2006-2006	FREIGHTLINER	CLASSIC XL	DETROIT DIESEL 6 CIL, 12.7 L DIESEL	2006-2007				
STERLING	L-LINE	CATERPILLAR C13 DIESEL	2006-2006	FREIGHTLINER	CLASSIC XL	DETROIT DIESEL 6 CIL, 14.0 L DIESEL	2005-2007				
STERLING	L-LINE	CATERPILLAR C13 DIESEL	2006-2006	FREIGHTLINER	COLUMBIA	DETROIT DIESEL 6 CIL, 14.0 L DIESEL	2008-2008				
INTERNATIONAL/NAVISTAR	4700	INTERNATIONAL/NAVISTAR 530 DIESEL	1999-2002	FREIGHTLINER	FLD	DETROIT DIESEL 6 CIL, 12.7 L DIESEL	2005-2008				
INTERNATIONAL/NAVISTAR	4700	INTERNATIONAL/NAVISTAR DT466	1997-2002	FREIGHTLINER	FLD	DETROIT DIESEL 6 CIL, 14.0 L DIESEL	2005-2007				
				FREIGHTLINER	FLD	DETROIT DIESEL SERIE 60	2006-2006				

MARCA	MODELO	MOTOR	AÑOS	MARCA	MODELO	MOTOR	AÑOS	
INTERNATIONAL/NAVISTAR	4700	INTERNATIONAL/NAVISTAR DT466	1995-1999	VOLVO	WIA SERIES	CUMMINS ISM DIESEL	1998-1999	
INTERNATIONAL/NAVISTAR	4800	INTERNATIONAL/NAVISTAR 530 DIESEL	2002-2002	VOLVO	WIA SERIES	CUMMINS L10 DIESEL	1997-1997	
INTERNATIONAL/NAVISTAR	4800	INTERNATIONAL/NAVISTAR DT466	1997-1999	VOLVO	WIA SERIES	CUMMINS N14 DIESEL	1998-1998	
INTERNATIONAL/NAVISTAR	4800	INTERNATIONAL/NAVISTAR DT466	1995-2003	VOLVO	WIA SERIES	VOLVO VE D12 DIESEL	1996-1997	
INTERNATIONAL/NAVISTAR	4900	INTERNATIONAL/NAVISTAR 530 DIESEL	1995-2002	VOLVO	XPEDITOR	CATERPILLAR 3306 DIESEL	1996-1996	
INTERNATIONAL/NAVISTAR	4900	INTERNATIONAL/NAVISTAR DT466	1997-2001					<div style="background-color: red; color: white; padding: 5px; text-align: center;"> 21042 MANGUERA INFERIOR </div>
INTERNATIONAL/NAVISTAR	4900	INTERNATIONAL/NAVISTAR DT466	1995-1999					
INTERNATIONAL/NAVISTAR	5500I	CATERPILLAR C13 DIESEL	2005-2007	FREIGHTLINER	CLASSIC	CUMMINS ISM DIESEL	2002-2003	
INTERNATIONAL/NAVISTAR	5500I	CUMMINS ISX DIESEL	2007-2007	FREIGHTLINER	CLASSIC XL	CUMMINS ISM DIESEL	2002-2003	
INTERNATIONAL/NAVISTAR	5600I	CUMMINS ISM DIESEL	2007-2007	FREIGHTLINER	FLD	CUMMINS ISM DIESEL	2002-2003	
INTERNATIONAL/NAVISTAR	7100	INTERNATIONAL/NAVISTAR DT466	1995-1995	INTERNATIONAL/NAVISTAR	3800	INTERNATIONAL/NAVISTAR T444 DIESEL	2001-2001	
INTERNATIONAL/NAVISTAR	7600	CATERPILLAR C13 DIESEL	2007-2008	INTERNATIONAL/NAVISTAR	3800	INTERNATIONAL/NAVISTAR T444 DIESEL	2001-2001	
INTERNATIONAL/NAVISTAR	8100	CATERPILLAR 3176 DIESEL	1996-1997	INTERNATIONAL/NAVISTAR	CONVENTIONAL IC	INTERNATIONAL/NAVISTAR T444 DIESEL	2002-2002	
INTERNATIONAL/NAVISTAR	8500	INTERNATIONAL/NAVISTAR DT570 DIESEL	2006-2006	INTERNATIONAL/NAVISTAR	DURASTAR 4300	INTERNATIONAL/NAVISTAR MAXXFORCE 7 DIESEL	2008-2008	
INTERNATIONAL/NAVISTAR	8500	INTERNATIONAL/NAVISTAR HT570 DIESEL	2007-2007	STERLING	SILVER STAR	CATERPILLAR C15 DIESEL	2000-2000	
INTERNATIONAL/NAVISTAR	9900IX	CUMMINS ISX DIESEL	2006-2006	VOLVO	AUTOCAR	DETROIT DIESEL 6 CIL, 11.1 L DIESEL	1999-1999	
INTERNATIONAL/NAVISTAR	CE	INTERNATIONAL/NAVISTAR DT466	2007-2007	VOLVO	AUTOCAR	DETROIT DIESEL 6 CIL, 12.7 L DIESEL	1999-1999	
INTERNATIONAL/NAVISTAR	PAYSTAR 5500i	CUMMINS ISX DIESEL	2008-2008	VOLVO	WG SERIES	CUMMINS ISM DIESEL	1998-2001	
KENWORTH	T2000	CATERPILLAR 3406 DIESEL	1997-1999	VOLVO	WG SERIES	CUMMINS ISM DIESEL	1998-2001	
KENWORTH	T2000	CATERPILLAR C15 DIESEL	2002-2002	VOLVO	WG SERIES	CUMMINS M11 DIESEL	1997-1997	
KENWORTH	T2000	CATERPILLAR C16 DIESEL	2002-2002	VOLVO	WG SERIES	CUMMINS M11 DIESEL	1997-1997	
KENWORTH	T300	CATERPILLAR 3126 DIESEL	1996-2003	VOLVO	XPEDITOR	CATERPILLAR 3306 DIESEL	1996-1996	
KENWORTH	T300	CUMMINS ISC DIESEL	1998-2004					<div style="background-color: red; color: white; padding: 5px; text-align: center;"> 20987 MANGUERA INFERIOR </div>
MACK	CHN SERIES	MACK AC DIESEL	2006-2007					
MACK	CHU SERIES	MACK MP8 DIESEL	2008-2010	FREIGHTLINER	COLUMBIA	DETROIT DIESEL 6 CIL, 14.0 L DIESEL	2009-2011	
MACK	CT SERIES	MACK AI DIESEL	2006-2007	FREIGHTLINER	COLUMBIA	DETROIT DIESEL 6 CIL, 14.0 L DIESEL	2009-2011	
MACK	CT SERIES	MACK AI DIESEL	2006-2007	INTERNATIONAL/NAVISTAR	3800	INTERNATIONAL/NAVISTAR DT466	2001-2001	
MACK	CTP SERIES	MACK MP7 DIESEL	2007-2007	INTERNATIONAL/NAVISTAR	8100	INTERNATIONAL/NAVISTAR DT466	1995-1995	
MACK	CXN SERIES	MACK AC DIESEL	2006-2007	INTERNATIONAL/NAVISTAR	CE	INTERNATIONAL/NAVISTAR DT466	2003-2004	
MACK	CXN SERIES	MACK AC DIESEL	2006-2007	INTERNATIONAL/NAVISTAR	CONVENTIONAL IC	INTERNATIONAL/NAVISTAR DT466	2002-2003	
MACK	CXP SERIES	MACK MP7 DIESEL	2007-2007	VOLVO	WG SERIES	CATERPILLAR 3306 DIESEL	1996-1997	
MACK	GRANITE	MACK MP8 DIESEL	2011-2013	VOLVO	WG SERIES	CATERPILLAR 3306 DIESEL	1996-1997	
STERLING	A-LINE	DETROIT DIESEL 6 CIL, 12.7 L DIESEL	2006-2006					<div style="background-color: red; color: white; padding: 5px; text-align: center;"> 20970 MANGUERA SUPERIOR </div>
STERLING	A-LINE	DETROIT DIESEL 6 CIL, 14.0 L DIESEL	2006-2006					
STERLING	A-LINE	DETROIT DIESEL SERIE 60	2005-2006	KENWORTH	K300	CUMMINS C Series 8.3 L DIESEL	1995-1995	
STERLING	L-LINE	DETROIT DIESEL 6 CIL, 12.7 L DIESEL	2006-2007					
STERLING	L-LINE	DETROIT DIESEL 6 CIL, 14.0 L DIESEL	2006-2007					
STERLING	L-LINE	DETROIT DIESEL SERIE 60	2006-2006					
VOLVO	VNL	CATERPILLAR 3406 DIESEL	1997-1999					
VOLVO	VNM	CATERPILLAR 3406 DIESEL	1997-1999					
VOLVO	WG SERIES	CUMMINS ISM DIESEL	1998-1999					
VOLVO	WG SERIES	CUMMINS L10 DIESEL	1996-1997					
VOLVO	WG SERIES	CUMMINS M11 DIESEL	1996-1997					

MARCA	MODELO	MOTOR	AÑOS	MARCA	MODELO	MOTOR	AÑOS
 20957 MANGUERA SUPERIOR				FORD	F-750 SUPER DUTY	CATERPILLAR 3126 DIESEL	2002-2004
				FORD	F-750 SUPER DUTY	CATERPILLAR 3126 DIESEL	2000-2004
STERLING	360	mitsubishi FUSO 4M50 DIESEL	2006-2013	FORD	F-750 SUPER DUTY	CUMMINS ISB DIESEL	2005-2006
 20748 MANGUERA INFERIOR				FORD	F-750 SUPER DUTY	FORD V8, 7.3 L DIESEL	2000-2004
				FORD	F-750 SUPER DUTY	FORD V8, 7.3 L DIESEL	2000-2004
INTERNATIONAL/NAVISTAR	5000	CUMMINS M11 DIESEL	2000-2000	FORD	F-750 SUPER DUTY	FORD V8, 7.3 L DIESEL	2000-2004
INTERNATIONAL/NAVISTAR	5000	CUMMINS N14 DIESEL	1999-2000	KENWORTH	T300	CATERPILLAR C7 DIESEL	2004-2004
INTERNATIONAL/NAVISTAR	5000	CUMMINS N14 DIESEL	1999-1999	STERLING	ACTERRA	MERCEDES-BENZ MBE 900 DIESEL	2005-2005
INTERNATIONAL/NAVISTAR	5500I	CUMMINS ISM DIESEL	2000-2000	 20532 MANGUERA SUPERIOR			
INTERNATIONAL/NAVISTAR	5500I	CUMMINS N14 DIESEL	2000-2000				
INTERNATIONAL/NAVISTAR	5600I	CUMMINS ISM DIESEL	2000-2000	KENWORTH	K100	CUMMINS C Series 8.3 L DIESEL	1992-1993
INTERNATIONAL/NAVISTAR	5600I	CUMMINS N14 DIESEL	2000-2000	 20206 MANGUERA SUPERIOR			
INTERNATIONAL/NAVISTAR	5600I	CUMMINS ISM DIESEL	2000-2000				
INTERNATIONAL/NAVISTAR	5900I	CUMMINS ISM DIESEL	2000-2000	FORD	F-650 SUPER DUTY	CUMMINS ISB DIESEL	2005-2007
INTERNATIONAL/NAVISTAR	5900I	CUMMINS N14 DIESEL	2000-2000	FORD	F-750 SUPER DUTY	CUMMINS ISB DIESEL	2005-2007
INTERNATIONAL/NAVISTAR	8100	CUMMINS ISM DIESEL	1999-1999	FREIGHTLINER	BUSINESS CLASS M2	MERCEDES BENZ MBE 900 DIESEL	2008-2008
INTERNATIONAL/NAVISTAR	PAYSTAR	CUMMINS M11 DIESEL	2000-2000	FREIGHTLINER	BUSINESS CLASS M2	MERCEDES BENZ MBE 900 DIESEL	2008-2008
INTERNATIONAL/NAVISTAR	PAYSTAR	CUMMINS N14 DIESEL	1999-2000	FREIGHTLINER	BUSINESS CLASS M2	MERCEDES-BENZ MBE 900 DIESEL	2004-2007
STERLING	A-LINE	DETROIT DIESEL SERIE 60	2005-2006	FREIGHTLINER	BUSINESS CLASS M2	MERCEDES-BENZ MBE 900 DIESEL	2006-2007
STERLING	L-LINE	DETROIT DIESEL SERIE 60	2006-2006	INTERNATIONAL/NAVISTAR	7600	CATERPILLAR C13 DIESEL	2004-2005
 20731 MANGUERA SUPERIOR				KENWORTH	T300	CATERPILLAR C7 DIESEL	2004-2004
				KENWORTH	T300	CATERPILLAR C7 DIESEL	2005-2007
INTERNATIONAL/NAVISTAR	4300	INTERNATIONAL/NAVISTAR DT466	2002-2008	STERLING	ACTERRA	CATERPILLAR C7 DIESEL	2005-2007
INTERNATIONAL/NAVISTAR	4400	INTERNATIONAL/NAVISTAR 530 DIESEL	2002-2005	STERLING	ACTERRA	CATERPILLAR C7 DIESEL	2005-2007
INTERNATIONAL/NAVISTAR	4400	INTERNATIONAL/NAVISTAR DT466	2002-2008	STERLING	ACTERRA	CATERPILLAR C7 DIESEL	2006-2007
INTERNATIONAL/NAVISTAR	4400	INTERNATIONAL/NAVISTAR DT570 DIESEL	2004-2008	STERLING	ACTERRA	CUMMINS ISC DIESEL	2005-2005
INTERNATIONAL/NAVISTAR	CE	INTERNATIONAL/NAVISTAR DT466	2008-2008	STERLING	ACTERRA	CUMMINS ISC DIESEL	2005-2007
INTERNATIONAL/NAVISTAR	CE	INTERNATIONAL/NAVISTAR MAXXFORCE DT DIESEL	2008-2008	STERLING	ACTERRA	MERCEDES-BENZ MBE 900 DIESEL	2007-2007
INTERNATIONAL/NAVISTAR	DURASTAR 4300	INTERNATIONAL/NAVISTAR MAXXFORCE DT DIESEL	2012-2012	STERLING	A-LINE	CATERPILLAR C9 DIESEL	2004-2004
 20611 MANGUERA INFERIOR				STERLING	L-LINE	CATERPILLAR 3126 DIESEL	2002-2004
				STERLING	L-LINE	CATERPILLAR C9 DIESEL	2004-2004
FORD	F-650 SUPER DUTY	CATERPILLAR 3126 DIESEL	2002-2004	 20172 MANGUERA INFERIOR			
FORD	F-650 SUPER DUTY	CATERPILLAR 3126 DIESEL	2000-2004				
FORD	F-650 SUPER DUTY	CUMMINS ISB DIESEL	2005-2005	INTERNATIONAL/NAVISTAR	4600	INTERNATIONAL/NAVISTAR T444 DIESEL	1995-1995
FORD	F-650 SUPER DUTY	CUMMINS ISB DIESEL	2006-2006	INTERNATIONAL/NAVISTAR	4700	INTERNATIONAL/NAVISTAR T444 DIESEL	1995-2000
FORD	F-650 SUPER DUTY	FORD V8, 7.3 L DIESEL	2000-2004	INTERNATIONAL/NAVISTAR	4800	INTERNATIONAL/NAVISTAR T444 DIESEL	1995-1997
FORD	F-650 SUPER DUTY	FORD V8, 7.3 L DIESEL	2000-2004	INTERNATIONAL/NAVISTAR	4900	INTERNATIONAL/NAVISTAR T444 DIESEL	1995-1997

MARCA	MODELO	MOTOR	AÑOS	MARCA	MODELO	MOTOR	AÑOS
 <p>19812 MANGUERA SUPERIOR</p>				FORD	F-450 SUPER DUTY	FORD V10, 6.8 L	1999-2004
				FORD	F-450 SUPER DUTY	FORD V8, 7.3 L DIESEL	2000-2003
				FORD	F-550 SUPER DUTY	FORD V10, 6.8 L	1999-2004
				FORD	F-550 SUPER DUTY	FORD V8, 7.3 L DIESEL	2000-2004
 <p>19201 MANGUERA DE CALEFACCIÓN</p>				FORD	F-450 SUPER DUTY	FORD V8, 7.3 L DIESEL	2000-2003
				FORD	F-550 SUPER DUTY	FORD V8, 7.3 L DIESEL	2000-2004
 <p>19200 MANGUERA DE CALEFACCIÓN</p>				FORD	F-450 SUPER DUTY	FORD V8, 7.3 L DIESEL	2000-2003
				FORD	F-550 SUPER DUTY	FORD V8, 7.3 L DIESEL	2000-2004
 <p>19747 MANGUERA DE CALEFACCIÓN</p>				CHEVROLET	S-10	4 CIL, 2.2 L	1999-2003
 <p>19707 MANGUERA DE CALEFACCIÓN</p>				CHEVROLET	S-10	V6, 4.3 L	1999-2002
 <p>19306 MANGUERA DE CALEFACCIÓN</p>				FORD	F-450 SUPER DUTY	FORD V10, 6.8 L	1999-2004
				FORD	F-550 SUPER DUTY	FORD V10, 6.8 L	1999-2004
 <p>19191 MANGUERA DE CALEFACCIÓN</p>				FORD	E450 SUPER DUTY	FORD V10, 6.8 L	2001-2002
				FORD	E450 SUPER DUTY	FORD V8, 5.4 L	2000-2002
				FORD	E550 SUPER DUTY	FORD V10, 6.8 L	2002-2003
 <p>19180 MANGUERA DE CALEFACCIÓN</p>				FORD	E450 SUPER DUTY	FORD V8, 7.3 L DIESEL	1998-1998
 <p>19277 MANGUERA DE CALEFACCIÓN</p>				FORD	E450 SUPER DUTY	FORD V10, 6.8 L	2001-2002
				FORD	E450 SUPER DUTY	FORD V8, 5.4 L	2000-2002
				FORD	E550 SUPER DUTY	FORD V10, 6.8 L	2002-2003
 <p>19227 MANGUERA DE PASO</p>				FORD	RANGER	4 CIL, 2.3 L	2001-2001
 <p>19218 MANGUERA DE CALEFACCIÓN</p>				FORD	F-450 SUPER DUTY	FORD V10, 6.8 L	1999-2004
				FORD	F-550 SUPER DUTY	FORD V10, 6.8 L	1999-2004
 <p>19140 MANGUERA DE CALEFACCIÓN</p>				FORD	RANGER	4 CIL, 2.3 L	2001-2002
 <p>19070 MANGUERA DE CALEFACCIÓN</p>				CHEVROLET	S-10	V6, 4.3 L	1999-2002
 <p>19025 MANGUERA DE PASO</p>				CHEVROLET	S-10	V6, 4.3 L	1996-2002
 <p>18916 MANGUERA DE CALEFACCIÓN</p>				FORD	RANGER	4 CIL, 2.5 L	2000-2001

MARCA	MODELO	MOTOR	AÑOS	MARCA	MODELO	MOTOR	AÑOS
 <div style="background-color: red; color: white; padding: 5px; text-align: center;"> 18785 MANGUERA DE CALEFACCIÓN </div>							
FORD	E450 SUPER DUTY	FORD V8, 7.3 L DIESEL	1998-1998				
 <div style="background-color: red; color: white; padding: 5px; text-align: center;"> 18774 MANGUERA DE CALEFACCIÓN </div>							
DODGE	RAM-4000	V6, 6.7 L DIESEL	2008-2011				
 <div style="background-color: red; color: white; padding: 5px; text-align: center;"> 18710 MANGUERA DE CALEFACCIÓN </div>							
DODGE	RAM-4000	V6, 6.7 L DIESEL	2008-2013				
 <div style="background-color: red; color: white; padding: 5px; text-align: center;"> 18703 MANGUERA DE CALEFACCIÓN </div>							
FORD	E450 SUPER DUTY	FORD V8, 7.3 L DIESEL	1998-1998				
 <div style="background-color: red; color: white; padding: 5px; text-align: center;"> 18079 MANGUERA DE ENFRIAMIENTO </div>							
CHEVROLET	S-10	4 CIL, 2.2 L	1999-2003				



MASTER SERVICIO PESADO 2014

MANGUERAS

MARCA	MODELO	MOTOR	AÑOS	MARCA	MODELO	MOTOR	AÑOS
12T150				FREIGHTLINER	BUSINESS CLASS	CUMMINS ISC DIESEL	2004-2011
NISSAN	PICK-UP	4 CIL, 2.4 L	1993-1994	FREIGHTLINER	M2 CENTURY CLASS	CUMMINS M11 DIESEL	1996-1997
12T202				FREIGHTLINER	FLC	CATERPILLAR 3176 DIESEL	1993-1995
CHEVROLET	S-10	4 CIL, 2.2 L	1994-1994	FREIGHTLINER	FLD	CUMMINS ISM DIESEL	1999-1999
NISSAN	ESTAQUITAS	4 CIL, 1.8 L	1993-1994	FREIGHTLINER	FLD	CUMMINS L10 DIESEL	1991-1993
1517T200				INTERNATIONAL/NAVISTAR	8100	CUMMINS N14 DIESEL	1995-1996
FORD	F-450 SUPER DUTY	V8, 7.5 L	1997-1997	INTERNATIONAL/NAVISTAR	9200	CATERPILLAR 3176 DIESEL	1995-1995
17T165				INTERNATIONAL/NAVISTAR	WORKSTAR 7500	INTERNATIONAL/NAVISTAR MAXXFORCE 10 DIESEL	2008-2008
MERCEDES BENZ	1417	OM 366	1990-1994	KENWORTH	T800	CUMMINS ISL DIESEL	2001-2009
MERCEDES BENZ	1521	OM 366	1990-1994	STERLING	L-LINE	DETROIT DIESEL 6 CIL, 14.0 L DIESEL	2006-2007
MERCEDES BENZ	2121	OM 366	1990-1994	FREIGHTLINER	CENTURY CLASS	CUMMINS ISM DIESEL	1998-2000
MERCEDES BENZ	1314	OM 366	1990-1994	FREIGHTLINER	FL112	CUMMINS M11 DIESEL	1996-1997
MERCEDES BENZ	1114	OM 366	1990-1994	FREIGHTLINER	FLD	CATERPILLAR 3176 DIESEL	1991-1992
MERCEDES BENZ	1317	OM 366	1990-1994	INTERNATIONAL/NAVISTAR	5600I	CUMMINS ISM DIESEL	2000-2000
MERCEDES BENZ	1517	OM 366	1990-1994	INTERNATIONAL/NAVISTAR	5600I	CUMMINS N14 DIESEL	2000-2000
22T220				INTERNATIONAL/NAVISTAR	5900I	CUMMINS N14 DIESEL	2000-2000
DINA	S-600	INTERNATIONAL/NAVISTAR DT466	1990-1997	INTERNATIONAL/NAVISTAR	7400	INTERNATIONAL/NAVISTAR DT466	2002-2003
24032				INTERNATIONAL/NAVISTAR	7500	INTERNATIONAL/NAVISTAR 530 DIESEL	2002-2003
FREIGHTLINER	BUSINESS CLASS M2	MERCEDES-BENZ MBE 900 DIESEL	2006-2007	INTERNATIONAL/NAVISTAR	8100	CUMMINS ISM DIESEL	1999-1999
24047				INTERNATIONAL/NAVISTAR	8200	CUMMINS M11 DIESEL	1995-1997
FREIGHTLINER	COLUMBIA	MERCEDES BENZ MBE 4000 Diesel	2008-2010	INTERNATIONAL/NAVISTAR	8600	CUMMINS ISM DIESEL	2003-2003
FREIGHTLINER	CASCADIA	MERCEDES BENZ MBE 4000 Diesel	2008-2012	KENWORTH	T300	CUMMINS ISC DIESEL	2006-2006
FREIGHTLINER	CLASSIC XL	MERCEDES BENZ MBE 4000 Diesel	2009-2010	KENWORTH	T600	CUMMINS L10 DIESEL	1991-1994
FREIGHTLINER	CLASSIC	MERCEDES BENZ MBE 4000 Diesel	2009-2010	STERLING	A-LINE	DETROIT DIESEL 6 CIL, 12.7 L DIESEL	2006-2006
FREIGHTLINER	CENTURY CLASS	MERCEDES BENZ MBE 4000 Diesel	2009-2010	STERLING	L-LINE	DETROIT DIESEL SERIE 60	2006-2006
FREIGHTLINER	FLD	MERCEDES BENZ MBE 4000 Diesel	2009-2010	VOLVO	VNL	CUMMINS ISM DIESEL	2003-2003
24222				FREIGHTLINER	FLC	CUMMINS M11 DIESEL	1995-1997
KENWORTH	C500	CATERPILLAR 3306 DIESEL	1991-1992	INTERNATIONAL/NAVISTAR	5000	CUMMINS N14 DIESEL	1999-1999
24236				INTERNATIONAL/NAVISTAR	5500I	CUMMINS ISM DIESEL	2000-2000
KENWORTH	T300	CUMMINS ISC DIESEL	2005-2005	INTERNATIONAL/NAVISTAR	5900I	CUMMINS ISM DIESEL	2000-2000
KENWORTH	T300	CUMMINS ISC DIESEL	2005-2005	INTERNATIONAL/NAVISTAR	8100	CUMMINS M11 DIESEL	1995-1997
24240				INTERNATIONAL/NAVISTAR	8200	CUMMINS L10 DIESEL	1995-1997
KENWORTH	T300	CUMMINS ISC DIESEL	2005-2005	INTERNATIONAL/NAVISTAR	8200	INTERNATIONAL/NAVISTAR DT466	1997-1997
INTERNATIONAL/NAVISTAR	WORKSTAR 7600	CUMMINS ISM DIESEL	2008-2009	INTERNATIONAL/NAVISTAR	9300	CATERPILLAR 3176 DIESEL	1995-1995
INTERNATIONAL/NAVISTAR	WORKSTAR 7600	CUMMINS ISM DIESEL	2008-2009	KENWORTH	K100	CUMMINS N14 DIESEL	1992-1993
24432				KENWORTH	T800	CUMMINS ISL	2006-2006
FORD	F-800	CUMMINS ISB DIESEL	1998-1999	KENWORTH	T800	CUMMINS ISL	2006-2006
STERLING	ACTERRA	CATERPILLAR 3126 DIESEL	2003-2003	KENWORTH	T800	CUMMINS ISL DIESEL	2001-2009
FORD	F-800	CUMMINS ISB DIESEL	1998-1999	MACK	CV SERIES	MACK AMI DIESEL	2005-2005
KENWORTH	T800	CUMMINS ISL	2006-2006	STERLING	A-LINE	DETROIT DIESEL SERIE 60	2005-2006
STERLING	ACTERRA	CATERPILLAR 3126 DIESEL	2003-2003	FREIGHTLINER	CLASSIC XL	CUMMINS ISM DIESEL	2003-2003
STERLING	L-LINE	CATERPILLAR 3126 DIESEL	2001-2001	FREIGHTLINER	FL112	CUMMINS ISM DIESEL	1998-1998
FORD	F-800	CUMMINS ISB DIESEL	1998-1999	FREIGHTLINER	FLD	CUMMINS ISM DIESEL	1998-2003
FORD	F-800	CUMMINS ISB DIESEL	1998-1999	INTERNATIONAL/NAVISTAR	5000	CUMMINS L10 DIESEL	1995-1998
STERLING	L-LINE	CATERPILLAR 3126 DIESEL	2001-2001	INTERNATIONAL/NAVISTAR	5000	INTERNATIONAL/NAVISTAR 530 DIESEL	1995-1995
24436				INTERNATIONAL/NAVISTAR	5500I	CUMMINS N14 DIESEL	2000-2000
				INTERNATIONAL/NAVISTAR	5600I	CUMMINS ISM DIESEL	2000-2000



MASTER SERVICIO PESADO 2014

MANGUERAS

MARCA	MODELO	MOTOR	AÑOS	MARCA	MODELO	MOTOR	AÑOS
INTERNATIONAL/NAVISTAR	5600I	CUMMINS N14 DIESEL	2000-2000	FREIGHTLINER	FLC	CATERPILLAR 3176 DIESEL	1991-1992
INTERNATIONAL/NAVISTAR	5900I	CUMMINS N14 DIESEL	2000-2000	INTERNATIONAL/NAVISTAR	5000	CUMMINS N14 DIESEL	1999-1999
INTERNATIONAL/NAVISTAR	8100	CUMMINS L10 DIESEL	1997-1997	INTERNATIONAL/NAVISTAR	5500I	CUMMINS ISM DIESEL	2000-2000
INTERNATIONAL/NAVISTAR	8100	INTERNATIONAL/NAVISTAR 530 DIESEL	1995-1999	INTERNATIONAL/NAVISTAR	5600I	CUMMINS ISM DIESEL	2000-2000
INTERNATIONAL/NAVISTAR	8100	INTERNATIONAL/NAVISTAR DT466	1995-1997	INTERNATIONAL/NAVISTAR	5900I	CUMMINS N14 DIESEL	2000-2000
INTERNATIONAL/NAVISTAR	8200	CUMMINS N14 DIESEL	1995-1996	INTERNATIONAL/NAVISTAR	8100	CUMMINS L10 DIESEL	1995-1996
INTERNATIONAL/NAVISTAR	9400	CATERPILLAR 3176 DIESEL	1995-1997	KENWORTH	T300	CUMMINS ISC DIESEL	2007-2008
KENWORTH	C500	CATERPILLAR 3176 DIESEL	1992-1993	KENWORTH	T400	CATERPILLAR 3176 DIESEL	1991-1992
KENWORTH	K100	CUMMINS 6 CIL. 14.0 L DIESEL	1991-1991	KENWORTH	T450	CATERPILLAR 3176 DIESEL	1991-1992
KENWORTH	T400	CATERPILLAR 3176 DIESEL	1991-1993	KENWORTH	T450	CUMMINS L10 DIESEL	1991-1994
KENWORTH	T400	CUMMINS L10 DIESEL	1991-1994	KENWORTH	T600	CATERPILLAR 3176 DIESEL	1991-1992
KENWORTH	T600	CATERPILLAR 3176 DIESEL	1991-1993	KENWORTH	T800	CATERPILLAR 3176 DIESEL	1991-1992
KENWORTH	T800	CATERPILLAR 3176 DIESEL	1991-1993	KENWORTH	T800	CUMMINS ISM DIESEL	2003-2003
KENWORTH	T800	CUMMINS L10 DIESEL	1991-1994	MACK	CH SERIES	MACK AC DIESEL	2003-2006
STERLING	ACTERRA	CUMMINS ISC DIESEL	2005-2008	VOLVO	XPEDITOR	CUMMINS L10 DIESEL	1996-1996
FORD	F-600	CUMMINS C Series 8.3 L DIESEL	1993-1994	FREIGHTLINER	BUSINESS CLASS M2	CUMMINS ISC DIESEL	2007-2011
FREIGHTLINER	CLASSIC	CUMMINS ISM DIESEL	2003-2003	FREIGHTLINER	FL112	CUMMINS ISM DIESEL	1998-1998
FREIGHTLINER	FL112	CUMMINS ISM DIESEL	1998-2001	FREIGHTLINER	FLD	CUMMINS M11 DIESEL	1995-1997
FREIGHTLINER	FLC	CUMMINS L10 DIESEL	1991-1993	INTERNATIONAL/NAVISTAR	5000	CUMMINS N14 DIESEL	1999-1999
FREIGHTLINER	FLD	CATERPILLAR 3176 DIESEL	1993-1995	INTERNATIONAL/NAVISTAR	5500I	CUMMINS ISM DIESEL	2000-2000
FREIGHTLINER	FLD	CUMMINS ISM DIESEL	1999-1999	INTERNATIONAL/NAVISTAR	5900I	CUMMINS ISM DIESEL	2000-2000
INTERNATIONAL/NAVISTAR	5000	CUMMINS L10 DIESEL	1995-1998	INTERNATIONAL/NAVISTAR	7400	INTERNATIONAL/NAVISTAR 530 DIESEL	2002-2003
INTERNATIONAL/NAVISTAR	5500I	CUMMINS N14 DIESEL	2000-2000	INTERNATIONAL/NAVISTAR	7500	INTERNATIONAL/NAVISTAR DT530 DIESEL	2004-2005
INTERNATIONAL/NAVISTAR	5900I	CUMMINS ISM DIESEL	2000-2000	INTERNATIONAL/NAVISTAR	8200	INTERNATIONAL/NAVISTAR 530 DIESEL	1996-1997
INTERNATIONAL/NAVISTAR	7400	INTERNATIONAL/NAVISTAR DT530 DIESEL	2004-2005	KENWORTH	T300	CUMMINS ISC DIESEL	1998-2006
INTERNATIONAL/NAVISTAR	8200	CUMMINS ISM DIESEL	1998-1998	KENWORTH	T800	CUMMINS ISL	2006-2006
KENWORTH	C500	CATERPILLAR 3176 DIESEL	1992-1992	KENWORTH	T800	CUMMINS ISL DIESEL	2001-2009
KENWORTH	T450	CATERPILLAR 3176 DIESEL	1991-1993	KENWORTH	W900	CUMMINS 6 CIL. 14.0 L DIESEL	1991-1991
KENWORTH	T800	CUMMINS ISL DIESEL	2008-2008				
MACK	CV SERIES	MACK AI DIESEL	2006-2007	INTERNATIONAL/NAVISTAR	8100	CUMMINS ISM DIESEL	1998-1998
MACK	CX SERIES	MACK AC DIESEL	2003-2006	INTERNATIONAL/NAVISTAR	8200	CUMMINS M11 DIESEL	1995-1995
STERLING	A-LINE	DETROIT DIESEL 6 CIL. 14.0 L DIESEL	2006-2006	INTERNATIONAL/NAVISTAR	8100	CUMMINS M11 DIESEL	1995-1997
FORD	F-750 SUPER DUTY	CUMMINS ISB DIESEL	2005-2007				
FREIGHTLINER	FLD	CUMMINS ISM DIESEL	1999-1999				
INTERNATIONAL/NAVISTAR	5500I	CUMMINS N14 DIESEL	2000-2000	FREIGHTLINER	COLUMBIA	MERCEDES BENZ MBE 4000 Diesel	2008-2010
INTERNATIONAL/NAVISTAR	5600I	CUMMINS N14 DIESEL	2000-2000	KENWORTH	T800	CUMMINS ISL	2006-2006
INTERNATIONAL/NAVISTAR	7500	INTERNATIONAL/NAVISTAR DT466	2002-2002	STERLING	A-LINE	CUMMINS N14 DIESEL	2001-2002
INTERNATIONAL/NAVISTAR	8100	CUMMINS ISM DIESEL	1998-1998	STERLING	A-LINE	DETROIT DIESEL SERIE 60	2001-2001
KENWORTH	K300	CUMMINS C Series 8.3 L DIESEL	1993-1994	STERLING	L-LINE	DETROIT DIESEL SERIE 60	2001-2001
KENWORTH	T800	CUMMINS ISL DIESEL	2008-2008	STERLING	L-LINE	DETROIT DIESEL SERIE 60	2002-2006
KENWORTH	W900	CUMMINS N14 DIESEL	1992-1993	FREIGHTLINER	CLASSIC	MERCEDES BENZ MBE 4000 Diesel	2009-2010
MACK	CXN SERIES	MACK AC DIESEL	2006-2007	FREIGHTLINER	CENTURY CLASS	MERCEDES BENZ MBE 4000 Diesel	2009-2010
STERLING	ACTERRA	CUMMINS ISC DIESEL	2008-2008	FREIGHTLINER	FLD	MERCEDES BENZ MBE 4000 Diesel	2009-2010
STERLING	L-LINE	DETROIT DIESEL 6 CIL. 12.7 L DIESEL	2006-2007	STERLING	A-LINE	DETROIT DIESEL SERIE 60	2001-2001
VOLVO	VNL	CUMMINS ISM DIESEL	2003-2003	STERLING	L-LINE	CUMMINS N14 DIESEL	2001-2002
FORD	F-650 SUPER DUTY	CUMMINS ISB DIESEL	2005-2007	STERLING	L-LINE	CUMMINS SIGNATURE 600 DIESEL	2001-2001
FREIGHTLINER	ARGOSY	CUMMINS ISM DIESEL	1999-2000	FREIGHTLINER	CLASSIC XL	MERCEDES BENZ MBE 4000 Diesel	2009-2010
				STERLING	ACTERRA	CATERPILLAR 3126 DIESEL	2003-2003

24438

24440



MASTER SERVICIO PESADO 2014

MANGUERAS

MARCA	MODELO	MOTOR	AÑOS	MARCA	MODELO	MOTOR	AÑOS
FREIGHTLINER	CASCADIA	MERCEDES BENZ MBE 4000 Diesel	2008-2012	FREIGHTLINER	FLD	MERCEDES BENZ MBE 4000 Diesel	2009-2010
FREIGHTLINER	CORONADO	DETROIT DIESEL SERIE 60	2005-2005	FREIGHTLINER	CLASSIC XL	MERCEDES BENZ MBE 4000 Diesel	2009-2010
STERLING	A-LINE	CUMMINS N14 DIESEL	2001-2002	FREIGHTLINER	CENTURY CLASS	MERCEDES BENZ MBE 4000 Diesel	2009-2010
STERLING	L-LINE	CUMMINS N14 DIESEL	2001-2002	FREIGHTLINER	CASCADIA	MERCEDES BENZ MBE 4000 Diesel	2008-2012
STERLING	L-LINE	DETROIT DIESEL SERIE 60	2001-2003	FREIGHTLINER	CLASSIC	MERCEDES BENZ MBE 4000 Diesel	2009-2010
FREIGHTLINER	BUSINESS CLASS M2	CATERPILLAR C13 DIESEL	2009-2010	FREIGHTLINER	COLUMBIA	MERCEDES BENZ MBE 4000 Diesel	2008-2010
FREIGHTLINER	CORONADO	DETROIT DIESEL SERIE 60	2005-2005	26132			
STERLING	ACTERRA	CATERPILLAR C13 DIESEL	2004-2004	MERCEDES BENZ	TORINO	MB 906	2005-2010
STERLING	A-LINE	DETROIT DIESEL SERIE 60	2001-2002	26510			
STERLING	L-LINE	CUMMINS N14 DIESEL	2001-2002	FREIGHTLINER	FLD	CUMMINS N14 DIESEL	1992-1997
FREIGHTLINER	CORONADO	DETROIT DIESEL SERIE 60	2005-2005	FREIGHTLINER	FLC	CUMMINS N14 DIESEL	1992-1996
STERLING	A-LINE	CUMMINS N14 DIESEL	2001-2002	26529			
STERLING	L-LINE	CATERPILLAR 3126 DIESEL	2001-2003	KENWORTH	T2000	DETROIT DIESEL SERIE 60	2000-2000
FREIGHTLINER	COLUMBIA	CATERPILLAR C15 DIESEL	2006-2007	KENWORTH	T2000	CUMMINS N14 DIESEL	1998-2000
STERLING	A-LINE	DETROIT DIESEL SERIE 60	2002-2006	26532			
STERLING	L-LINE	DETROIT DIESEL SERIE 60	2001-2003	KENWORTH	T2000	CUMMINS ISX DIESEL	1999-2003
24444				KENWORTH	K300	CUMMINS C Series 8.3 L DIESEL	1995-1995
VOLVO	VT880	CUMMINS ISX DIESEL	2006-2006	21170			
24452				FREIGHTLINER	FLD	CUMMINS N14 DIESEL	1991-1997
KENWORTH	T2000	CATERPILLAR 3406 DIESEL	2000-2000	FREIGHTLINER	FLC	CUMMINS N14 DIESEL	1991-1998
KENWORTH	T800	CUMMINS ISL DIESEL	2008-2008	21200			
KENWORTH	T800	CUMMINS ISL DIESEL	2001-2009	KENWORTH	K100	CUMMINS C Series 8.3 L DIESEL	1992-1993
FREIGHTLINER	COLUMBIA	CATERPILLAR C15 DIESEL	2001-2003	30T 3/4"			
FREIGHTLINER	COLUMBIA	CATERPILLAR C16 DIESEL	2001-2004	FORD	F-600	CUMMINS B Series 5.9 L DIESEL	1992-1994
24832				FREIGHTLINER	FLD	CATERPILLAR 3176 DIESEL	1991-1995
VOLVO	7550 FL	B12	2005-2008	FREIGHTLINER	FLD	CUMMINS N14 DIESEL	1991-1997
VOLVO	9700 FL	B12	2005-2011	FREIGHTLINER	FLD	DETROIT DIESEL 6 CIL, 12.7 L DIESEL	1991-1998
VOLVO	7550	7550	2001-2006	INTERNATIONAL/NAVISTAR	8200	CUMMINS M11 DIESEL	1995-1996
VOLVO	9700	B12	2002-2006	INTERNATIONAL/NAVISTAR	8100	CUMMINS M11 DIESEL	1995-1997
24838				INTERNATIONAL/NAVISTAR	8100	INTERNATIONAL/NAVISTAR DT466	1995-1995
VOLVO	7550	7550	2001-2006	KENWORTH	C500	DETROIT DIESEL 6 CIL, 12.7 L DIESEL	1994-1994
VOLVO	9700 FL	B12	2005-2011	KENWORTH	W900	DETROIT DIESEL 6 CIL, 12.7 L DIESEL	1994-1999
VOLVO	7550 FL	B12	2005-2008	FREIGHTLINER	FLD	CATERPILLAR 3306 DIESEL	1991-1994
VOLVO	9700	B12	2002-2006	KENWORTH	W900	DETROIT DIESEL 6 CIL, 11.1 L DIESEL	1994-1999
251140				FREIGHTLINER	CENTURY CLASS	DETROIT DIESEL 6 CIL, 11.1 L DIESEL	1998-1998
FREIGHTLINER	FLC	CUMMINS N14 DIESEL	1997-1997	FREIGHTLINER	CENTURY CLASS	DETROIT DIESEL 6 CIL, 12.7 L DIESEL	1998-1998
251140 GS				FREIGHTLINER	FLD	CUMMINS L10 DIESEL	1991-1993
KENWORTH	T2000	DETROIT DIESEL 6 CIL, 12.7 L DIESEL	2000-2000	FREIGHTLINER	FLD	DETROIT DIESEL 6 CIL, 11.1 L DIESEL	1991-1998
KENWORTH	T2000	CUMMINS N14 DIESEL	1997-2000	KENWORTH	K100	DETROIT DIESEL 6 CIL, 11.1 L DIESEL	1996-1996
KENWORTH	T2000	DETROIT DIESEL 6 CIL, 11.1 L DIESEL	2000-2000	CHEVROLET	S-10	4 CIL, 2.2 L	2002-2002
KENWORTH	T2000	CATERPILLAR C12 DIESEL	1997-1997	KENWORTH	T600	DETROIT DIESEL 6 CIL, 11.1 L DIESEL	1994-1999
251160 GS				CHEVROLET	C5500	CATERPILLAR 3126 DIESEL	1998-2002
KENWORTH	T2000	CUMMINS ISX DIESEL	2004-2006	FREIGHTLINER	FLC	CUMMINS L10 DIESEL	1991-1993
KENWORTH	T300	CATERPILLAR 3126 DIESEL	2000-2000	FREIGHTLINER	FLC	DETROIT DIESEL 6 CIL, 11.1 L DIESEL	1991-1998
KENWORTH	T800	CUMMINS ISX DIESEL	2003-2003	INTERNATIONAL/NAVISTAR	4700	INTERNATIONAL/NAVISTAR DT408 DIESEL	1995-1997
26045				KENWORTH	T600	CATERPILLAR 3406 DIESEL	1993-1999



MASTER SERVICIO PESADO 2014

MANGUERAS

MARCA	MODELO	MOTOR	AÑOS	MARCA	MODELO	MOTOR	AÑOS
KENWORTH	T800	DETROIT DIESEL 6 CIL, 12.7 L DIESEL	1994-1999	KENWORTH	C500	DETROIT DIESEL 6 CIL, 11.1 L DIESEL	1991-1994
CHEVROLET	C6500	CATERPILLAR 3126 DIESEL	1998-2002	KENWORTH	K100	CATERPILLAR 3406 DIESEL	1991-1994
FREIGHTLINER	FLC	CATERPILLAR 3306 DIESEL	1991-1994	KENWORTH	T400	CATERPILLAR 3176 DIESEL	1991-1993
KENWORTH	K100	DETROIT DIESEL 6 CIL, 12.7 L DIESEL	1994-1996	KENWORTH	T450	CUMMINS L10 DIESEL	1991-1994
CHEVROLET	C7500	CATERPILLAR 3126 DIESEL	1998-2002	KENWORTH	T800	CATERPILLAR 3176 DIESEL	1991-1993
CHEVROLET	C8500	CATERPILLAR 3126 DIESEL	1998-2002	KENWORTH	W900	DETROIT DIESEL 6 CIL, 11.1 L DIESEL	1991-1999
FREIGHTLINER	FLC	CATERPILLAR 3176 DIESEL	1991-1995	FORD	E450 SUPER DUTY	FORD V8, 7.3 L DIESEL	1998-1998
FREIGHTLINER	FLC	CUMMINS N14 DIESEL	1991-1998	FREIGHTLINER	CENTURY CLASS	DETROIT DIESEL 6 CIL, 11.1 L DIESEL	1998-1998
FREIGHTLINER	FLC	DETROIT DIESEL 6 CIL, 12.7 L DIESEL	1991-1998	FREIGHTLINER	FLD	CATERPILLAR 3176 DIESEL	1991-1995
INTERNATIONAL/NAVISTAR	4800	INTERNATIONAL/NAVISTAR DT408 DIESEL	1995-1997	FREIGHTLINER	FLD	CATERPILLAR 3306 DIESEL	1991-1992
INTERNATIONAL/NAVISTAR	4900	INTERNATIONAL/NAVISTAR DT408 DIESEL	1995-1997	KENWORTH	T450	CATERPILLAR 3306 DIESEL	1991-1996
INTERNATIONAL/NAVISTAR	8100	CUMMINS ISM DIESEL	1998-1998	KENWORTH	W900	CATERPILLAR 3406 DIESEL	1991-1999
KENWORTH	C500	DETROIT DIESEL 6 CIL, 11.1 L DIESEL	1994-1994	VOLVO	XPEDITOR	CATERPILLAR 3306 DIESEL	1996-1996
KENWORTH	T600	DETROIT DIESEL 6 CIL, 12.7 L DIESEL	1994-1999	FORD	F-600	FORD V8, 7.0 L	1991-1994
KENWORTH	T800	CATERPILLAR 3406 DIESEL	1993-1999	KENWORTH	K100	CUMMINS C Series 8.3 L DIESEL	1992-1993
KENWORTH	T800	DETROIT DIESEL 6 CIL, 11.1 L DIESEL	1994-1999	KENWORTH	K100	DETROIT DIESEL 6 CIL, 11.1 L DIESEL	1991-1996
		30T 5/8"		KENWORTH	T600	CUMMINS 6 CIL, 14.0 L DIESEL	1991-1991
CHEVROLET	C5500	CATERPILLAR 3126 DIESEL	1998-2002	KENWORTH	W900	CUMMINS 6 CIL, 14.0 L DIESEL	1991-1991
CHEVROLET	C7500	CATERPILLAR 3126 DIESEL	1998-2002	FREIGHTLINER	FLD	DETROIT DIESEL 6 CIL, 12.7 L DIESEL	1991-1998
CHEVROLET	C8500	CATERPILLAR 3126 DIESEL	1998-2002	INTERNATIONAL/NAVISTAR	8200	CUMMINS M11 DIESEL	1995-1996
FREIGHTLINER	FLC	CATERPILLAR 3176 DIESEL	1991-1995	KENWORTH	C500	DETROIT DIESEL 6 CIL, 12.7 L DIESEL	1991-1994
FREIGHTLINER	FLC	DETROIT DIESEL 6 CIL, 11.1 L DIESEL	1991-1998	KENWORTH	T600	CUMMINS L10 DIESEL	1991-1994
INTERNATIONAL/NAVISTAR	8100	CUMMINS ISM DIESEL	1998-1998	KENWORTH	T800	CATERPILLAR 3406 DIESEL	1991-1992
KENWORTH	T400	CUMMINS L10 DIESEL	1991-1994	FREIGHTLINER	CENTURY CLASS	DETROIT DIESEL 6 CIL, 12.7 L DIESEL	1998-1998
KENWORTH	T600	CATERPILLAR 3406 DIESEL	1991-1992	FREIGHTLINER	FLD	DETROIT DIESEL 6 CIL, 11.1 L DIESEL	1991-1998
KENWORTH	T600	DETROIT DIESEL 6 CIL, 11.1 L DIESEL	1991-1999	KENWORTH	T600	CATERPILLAR 3176 DIESEL	1991-1993
KENWORTH	T800	CUMMINS L10 DIESEL	1991-1994	KENWORTH	W900	CUMMINS N14 DIESEL	1992-1993
CHEVROLET	C6500	CATERPILLAR 3126 DIESEL	1998-2002	KENWORTH	W900	DETROIT DIESEL 6 CIL, 12.7 L DIESEL	1991-1999
FORD	E450 SUPER DUTY	FORD V8, 7.3 L DIESEL	1998-1998			35B 3/8"	
INTERNATIONAL/NAVISTAR	8100	CUMMINS M11 DIESEL	1995-1997	FORD	F-450 SUPER DUTY	FORD V8, 7.3 L DIESEL	2000-2003
KENWORTH	C500	CATERPILLAR 3306 DIESEL	1991-1992	INTERNATIONAL/NAVISTAR	4700	INTERNATIONAL/NAVISTAR DT408 DIESEL	1995-1997
KENWORTH	K100	DETROIT DIESEL 6 CIL, 12.7 L DIESEL	1991-1996	INTERNATIONAL/NAVISTAR	4800	INTERNATIONAL/NAVISTAR DT408 DIESEL	1995-1997
KENWORTH	T400	CATERPILLAR 3306 DIESEL	1991-1992	INTERNATIONAL/NAVISTAR	4900	INTERNATIONAL/NAVISTAR DT408 DIESEL	1995-1997
KENWORTH	T450	CATERPILLAR 3176 DIESEL	1991-1993	FORD	RANGER	V6, 3.0 L	2002-2002
KENWORTH	T800	CATERPILLAR 3306 DIESEL	1991-1992	FORD	E450 SUPER DUTY	FORD V8, 5.4 L	2002-2002
FORD	F-600	FORD V8, 6.1 L	1991-1991	INTERNATIONAL/NAVISTAR	8100	INTERNATIONAL/NAVISTAR DT466	1995-1995
FREIGHTLINER	FLC	CATERPILLAR 3306 DIESEL	1991-1992	CHEVROLET	S-10	4 CIL, 2.2 L	2002-2002
KENWORTH	C500	CATERPILLAR 3176 DIESEL	1992-1993	FORD	F-550 SUPER DUTY	FORD V8, 7.3 L DIESEL	2000-2004
KENWORTH	K100	CUMMINS 6 CIL, 14.0 L DIESEL	1991-1991			35B 5/8"	
KENWORTH	K100	CUMMINS N14 DIESEL	1992-1993	FREIGHTLINER	CENTURY CLASS	DETROIT DIESEL SERIE 60	1998-1998
KENWORTH	T600	CUMMINS N14 DIESEL	1992-1992	KENWORTH	T400	CUMMINS L10 DIESEL	1990-1994
KENWORTH	T600	DETROIT DIESEL 6 CIL, 12.7 L DIESEL	1991-1999	KENWORTH	T600	CUMMINS N14 DIESEL	1992-1992
KENWORTH	T800	CUMMINS 6 CIL, 14.0 L DIESEL	1991-1991	KENWORTH	T800	CATERPILLAR 3406 DIESEL	1990-1990
KENWORTH	T800	CUMMINS N14 DIESEL	1992-1992	FREIGHTLINER	FLC	DETROIT DIESEL SERIE 60	1990-1997
KENWORTH	T800	DETROIT DIESEL 6 CIL, 11.1 L DIESEL	1991-1999	KENWORTH	K100	CATERPILLAR 3406 DIESEL	1990-1990
KENWORTH	T800	DETROIT DIESEL 6 CIL, 12.7 L DIESEL	1991-1999	KENWORTH	K100	DETROIT DIESEL SERIE 60	1990-1999
FREIGHTLINER	FLC	DETROIT DIESEL 6 CIL, 12.7 L DIESEL	1991-1998	KENWORTH	T600	CUMMINS L10 DIESEL	1990-1994



MASTER SERVICIO PESADO 2014

MANGUERAS

MARCA	MODELO	MOTOR	AÑOS	MARCA	MODELO	MOTOR	AÑOS
KENWORTH	W900	CUMMINS N14 DIESEL	1992-1993	FREIGHTLINER	FLD	CUMMINS M11 DIESEL	1995-1999
KENWORTH	T600	CATERPILLAR 3406 DIESEL	1990-1990	FREIGHTLINER	FLD	DETROIT DIESEL 6 CIL, 11.1 L DIESEL	1991-1998
KENWORTH	T800	CUMMINS N14 DIESEL	1992-1992	KENWORTH	K100	DETROIT DIESEL SERIE 60	1990-1993
KENWORTH	T450	CATERPILLAR 3306 DIESEL	1990-1990	KENWORTH	T600	DETROIT DIESEL SERIE 60	1990-1993
KENWORTH	T600	DETROIT DIESEL SERIE 60	1990-1999	FREIGHTLINER	FL112	CUMMINS ISM DIESEL	1998-1999
KENWORTH	W900	CATERPILLAR 3406 DIESEL	1990-1990	FREIGHTLINER	FLD	DETROIT DIESEL SERIE 60	1990-1998
KENWORTH	K100	CUMMINS N14 DIESEL	1992-1993	KENWORTH	C500	DETROIT DIESEL 6 CIL, 12.7 L DIESEL	1991-1993
KENWORTH	T400	CATERPILLAR 3306 DIESEL	1990-1990	KENWORTH	W900	DETROIT DIESEL 6 CIL, 12.7 L DIESEL	1991-1993
KENWORTH	T800	CATERPILLAR 3306 DIESEL	1990-1990	FREIGHTLINER	FLD	DETROIT DIESEL 6 CIL, 12.7 L DIESEL	1991-1998
KENWORTH	W900	DETROIT DIESEL SERIE 60	1990-1999	KENWORTH	K100	DETROIT DIESEL 6 CIL, 11.1 L DIESEL	1991-1993
FREIGHTLINER	FLD	DETROIT DIESEL SERIE 60	1990-1998	FREIGHTLINER	CENTURY CLASS	CUMMINS ISM DIESEL	1998-1999
KENWORTH	T450	CUMMINS L10 DIESEL	1990-1994	FREIGHTLINER	FLC	DETROIT DIESEL SERIE 60	1990-1997
KENWORTH	T800	CUMMINS L10 DIESEL	1990-1994	FREIGHTLINER	FLD	CUMMINS ISM DIESEL	1998-1999
KENWORTH	T800	DETROIT DIESEL SERIE 60	1990-1999	KENWORTH	T600	DETROIT DIESEL 6 CIL, 11.1 L DIESEL	1991-1993
CHARTER 1 1/2"				FREIGHTLINER	CENTURY CLASS	DETROIT DIESEL 6 CIL, 12.7 L DIESEL	1998-1998
KENWORTH	T600	CUMMINS 6 CIL, 14.0 L DIESEL	1991-1991	FREIGHTLINER	FL112	CUMMINS M11 DIESEL	1996-1997
FREIGHTLINER	FLD	CUMMINS L10 DIESEL	1990-1993	FREIGHTLINER	FLC	CUMMINS M11 DIESEL	1995-1997
KENWORTH	K100	CUMMINS 6 CIL, 14.0 L DIESEL	1991-1991	FREIGHTLINER	FLC	DETROIT DIESEL 6 CIL, 11.1 L DIESEL	1991-1998
KENWORTH	T800	CUMMINS N14 DIESEL	1992-1992	KENWORTH	T800	DETROIT DIESEL 6 CIL, 12.7 L DIESEL	1991-1993
KENWORTH	W900	CUMMINS N14 DIESEL	1992-1993	KENWORTH	T800	DETROIT DIESEL SERIE 60	1990-1993
FORD	F-600	FORD 6 CIL, 7.8 L DIESEL	1991-1991	VOLVO	XPEDITOR	CATERPILLAR 3306 DIESEL	1996-1996
FREIGHTLINER	FLD	CUMMINS N14 DIESEL	1991-1997	KENWORTH	K100	DETROIT DIESEL 6 CIL, 12.7 L DIESEL	1991-1993
FORD	F-600	FORD 6 CIL, 6.6 L DIESEL	1991-1993	KENWORTH	W900	DETROIT DIESEL SERIE 60	1990-1993
FREIGHTLINER	FLC	CUMMINS N14 DIESEL	1991-1998	FREIGHTLINER	FLC	DETROIT DIESEL 6 CIL, 12.7 L DIESEL	1991-1998
FREIGHTLINER	FLC	CUMMINS L10 DIESEL	1990-1993	KENWORTH	C500	DETROIT DIESEL 6 CIL, 11.1 L DIESEL	1991-1993
KENWORTH	K100	CUMMINS N14 DIESEL	1992-1993	KENWORTH	T600	DETROIT DIESEL 6 CIL, 12.7 L DIESEL	1991-1993
KENWORTH	T600	CUMMINS N14 DIESEL	1992-1992	KENWORTH	T800	DETROIT DIESEL 6 CIL, 11.1 L DIESEL	1991-1993
KENWORTH	T800	CUMMINS 6 CIL, 14.0 L DIESEL	1991-1991	CHARTER 1"			
KENWORTH	W900	CUMMINS 6 CIL, 14.0 L DIESEL	1991-1991	KENWORTH	T450	CATERPILLAR 3176 DIESEL	1991-1993
CHARTER 1 1/4"				KENWORTH	C500	CATERPILLAR 3176 DIESEL	1992-1993
FREIGHTLINER	FLC	CUMMINS N14 DIESEL	1992-1997	KENWORTH	T800	CATERPILLAR 3306 DIESEL	1990-1992
KENWORTH	T800	CUMMINS N14 DIESEL	1992-1992	INTERNATIONAL/NAVISTAR	PAYSTAR	CUMMINS L10 DIESEL	1992-1993
KENWORTH	W900	CUMMINS N14 DIESEL	1992-1993	KENWORTH	K100	CATERPILLAR 3406 DIESEL	1990-1994
KENWORTH	K100	CUMMINS N14 DIESEL	1992-1993	INTERNATIONAL/NAVISTAR	4800	INTERNATIONAL/NAVISTAR DT408 DIESEL	1995-1997
KENWORTH	T450	CUMMINS L10 DIESEL	1990-1994	INTERNATIONAL/NAVISTAR	4900	INTERNATIONAL/NAVISTAR DT408 DIESEL	1995-1997
KENWORTH	T600	CUMMINS N14 DIESEL	1992-1992	INTERNATIONAL/NAVISTAR	5000	CUMMINS L10 DIESEL	1992-1993
FREIGHTLINER	FLD	CUMMINS N14 DIESEL	1992-1997	KENWORTH	T800	CATERPILLAR 3406 DIESEL	1990-1992
KENWORTH	T600	CUMMINS L10 DIESEL	1990-1994	INTERNATIONAL/NAVISTAR	4700	INTERNATIONAL/NAVISTAR DT408 DIESEL	1995-1997
KENWORTH	T400	CUMMINS L10 DIESEL	1990-1994	INTERNATIONAL/NAVISTAR	5000	CUMMINS N14 DIESEL	1992-1993
KENWORTH	T800	CUMMINS L10 DIESEL	1990-1994	KENWORTH	T600	CATERPILLAR 3406 DIESEL	1990-1992
CHARTER 1 3/4"				KENWORTH	W900	CATERPILLAR 3406 DIESEL	1990-1999
FREIGHTLINER	CENTURY CLASS	DETROIT DIESEL SERIE 60	1998-1998	INTERNATIONAL/NAVISTAR	PAYSTAR	CUMMINS N14 DIESEL	1992-1993
KENWORTH	C500	CATERPILLAR 3306 DIESEL	1991-1992	KENWORTH	T400	CATERPILLAR 3176 DIESEL	1991-1993
KENWORTH	W900	DETROIT DIESEL 6 CIL, 11.1 L DIESEL	1991-1993	KENWORTH	T600	CATERPILLAR 3176 DIESEL	1991-1993
FORD	F-600	CUMMINS B Series 5.9 L DIESEL	1992-1994	KENWORTH	T800	CATERPILLAR 3176 DIESEL	1991-1993
FREIGHTLINER	CENTURY CLASS	CUMMINS M11 DIESEL	1996-1999	CHARTER 2 1/2"			
FREIGHTLINER	CENTURY CLASS	DETROIT DIESEL 6 CIL, 11.1 L DIESEL	1998-1998	DINA	S-700	CUMMINS L10 DIESEL	1990-1997



MASTER SERVICIO PESADO 2014

MANGUERAS

MARCA	MODELO	MOTOR	AÑOS	MARCA	MODELO	MOTOR	AÑOS
FREIGHTLINER	CENTURY CLASS	CUMMINS ISM DIESEL	2001-2001	INTERNATIONAL/NAVISTAR	5000	CATERPILLAR C10 DIESEL	1998-2000
FREIGHTLINER	CENTURY CLASS	CUMMINS M11 DIESEL	1996-2000	INTERNATIONAL/NAVISTAR	5000	CUMMINS L10 DIESEL	1992-1997
FREIGHTLINER	CLASSIC	CUMMINS ISM DIESEL	2002-2003	INTERNATIONAL/NAVISTAR	5500	CUMMINS ISM DIESEL	2005-2005
FREIGHTLINER	CLASSIC	CUMMINS N14 DIESEL	2002-2002	INTERNATIONAL/NAVISTAR	5600I	CATERPILLAR C10 DIESEL	2001-2002
FREIGHTLINER	CLASSIC XL	CATERPILLAR C15 DIESEL	2002-2002	INTERNATIONAL/NAVISTAR	5600I	CATERPILLAR C12 DIESEL	2000-2002
FREIGHTLINER	CLASSIC XL	CATERPILLAR C16 DIESEL	2002-2002	INTERNATIONAL/NAVISTAR	7400	INTERNATIONAL/NAVISTAR DT570 DIESEL	2006-2006
FREIGHTLINER	COLUMBIA	DETROIT DIESEL SERIE 60	2001-2003	INTERNATIONAL/NAVISTAR	8100	CATERPILLAR C10 DIESEL	1998-1998
FREIGHTLINER	COLUMBIA	MERCEDES-BENZ MBE 4000 DIESEL	2004-2004	INTERNATIONAL/NAVISTAR	9200	CUMMINS ISM DIESEL	2005-2005
FREIGHTLINER	CORONADO	DETROIT DIESEL 6 CIL. 12.7 L DIESEL	2002-2003	INTERNATIONAL/NAVISTAR	9400	CUMMINS ISX DIESEL	2005-2005
FREIGHTLINER	CORONADO	DETROIT DIESEL SERIE 60	2004-2006	INTERNATIONAL/NAVISTAR	9400I	CATERPILLAR C15 DIESEL	2001-2001
FREIGHTLINER	FLC	CUMMINS M11 DIESEL	1995-1997	INTERNATIONAL/NAVISTAR	9400I	CATERPILLAR C16 DIESEL	2001-2001
FREIGHTLINER	FLD	CATERPILLAR C15 DIESEL	2002-2002	INTERNATIONAL/NAVISTAR	9400I	CUMMINS ISM DIESEL	2001-2003
FREIGHTLINER	FLD	CATERPILLAR C16 DIESEL	2002-2002	INTERNATIONAL/NAVISTAR	9900IX	CATERPILLAR C15 DIESEL	2001-2001
FREIGHTLINER	FLD	CUMMINS M11 DIESEL	1995-2000	INTERNATIONAL/NAVISTAR	9900IX	CUMMINS ISM DIESEL	2001-2002
FREIGHTLINER	FLD	CUMMINS N14 DIESEL	1992-1996	INTERNATIONAL/NAVISTAR	PAYSTAR	CUMMINS L10 DIESEL	1992-1993
INTERNATIONAL/NAVISTAR	5000	CUMMINS N14 DIESEL	1992-1993	KENWORTH	T2000	CATERPILLAR C16 DIESEL	2000-2001
INTERNATIONAL/NAVISTAR	5500I	CATERPILLAR C10 DIESEL	2001-2002	KENWORTH	T600	CUMMINS SIGNATURE 600 DIESEL	2003-2003
INTERNATIONAL/NAVISTAR	5500I	CATERPILLAR C12 DIESEL	2000-2002	KENWORTH	T800	CUMMINS M11 DIESEL	1995-2000
INTERNATIONAL/NAVISTAR	5600	CUMMINS ISX DIESEL	2005-2005	KENWORTH	W900	CATERPILLAR C10 DIESEL	2001-2004
INTERNATIONAL/NAVISTAR	5600I	CATERPILLAR C12 DIESEL	2000-2002	KENWORTH	W900	DETROIT DIESEL 6 CIL, 12.7 L DIESEL	2001-2001
INTERNATIONAL/NAVISTAR	5900I	CATERPILLAR C12 DIESEL	2000-2002	MACK	DM SERIES	MACK 6 CIL, 12.0 L DIESEL	2001-2001
INTERNATIONAL/NAVISTAR	7500	INTERNATIONAL/NAVISTAR HT570	2006-2006	STERLING	A-LINE	CATERPILLAR C15 DIESEL	2000-2001
INTERNATIONAL/NAVISTAR	9100I	CUMMINS ISM DIESEL	2001-2003	STERLING	L-LINE	CATERPILLAR C15 DIESEL	2001-2002
INTERNATIONAL/NAVISTAR	9200	CUMMINS ISM DIESEL	2005-2005	VOLVO	VNM	CUMMINS N14 DIESEL	1998-2003
INTERNATIONAL/NAVISTAR	9200I	CUMMINS ISM DIESEL	2001-2002	FREIGHTLINER	CENTURY CLASS	CUMMINS M11 DIESEL	1999-1999
INTERNATIONAL/NAVISTAR	9900IX	CATERPILLAR C16 DIESEL	2001-2001	FREIGHTLINER	CENTURY CLASS	CUMMINS N14 DIESEL	1998-2001
INTERNATIONAL/NAVISTAR	PAYSTAR	CUMMINS M11 DIESEL	1996-1998	FREIGHTLINER	CLASSIC	CUMMINS ISM DIESEL	2002-2003
KENWORTH	T2000	CATERPILLAR C16 DIESEL	2000-2001	FREIGHTLINER	CLASSIC XL	CUMMINS ISM DIESEL	2002-2002
KENWORTH	T600	CUMMINS M11 DIESEL	1995-1996	FREIGHTLINER	CORONADO	DETROIT DIESEL 6 CIL, 12.7 L DIESEL	2002-2003
KENWORTH	T800	CATERPILLAR C16 DIESEL	2001-2003	FREIGHTLINER	FL112	CUMMINS ISM DIESEL	2002-2003
KENWORTH	T800	CUMMINS N14 DIESEL	1998-2003	FREIGHTLINER	FLC	CUMMINS L10 DIESEL	1990-1993
KENWORTH	T800	DETROIT DIESEL 6 CIL, 12.7 L DIESEL	2000-2001	FREIGHTLINER	FLD	CATERPILLAR C10 DIESEL	2002-2003
KENWORTH	W900	CATERPILLAR C10 DIESEL	2001-2004	FREIGHTLINER	FLD	CATERPILLAR C12 DIESEL	2002-2003
STERLING	L-LINE	CATERPILLAR C15 DIESEL	2001-2002	FREIGHTLINER	FLD	CUMMINS M11 DIESEL	2000-2000
VOLVO	VT880	CUMMINS ISX DIESEL	2006-2006	FREIGHTLINER	FLD	CUMMINS N14 DIESEL	1992-2001
FREIGHTLINER	CLASSIC	CUMMINS N14 DIESEL	2002-2002	INTERNATIONAL/NAVISTAR	5000	CATERPILLAR C12 DIESEL	2000-2000
FREIGHTLINER	CLASSIC XL	CATERPILLAR C16 DIESEL	2002-2002	INTERNATIONAL/NAVISTAR	5000	CATERPILLAR C12 DIESEL	1998-1999
FREIGHTLINER	COLUMBIA	CATERPILLAR C13 DIESEL	2005-2005	INTERNATIONAL/NAVISTAR	5000	CUMMINS M11 DIESEL	1996-1998
FREIGHTLINER	COLUMBIA	CATERPILLAR C15 DIESEL	2005-2005	INTERNATIONAL/NAVISTAR	9000	CUMMINS ISM DIESEL	2004-2004
FREIGHTLINER	FL112	CUMMINS ISM DIESEL	2002-2003	INTERNATIONAL/NAVISTAR	9100I	CUMMINS ISM DIESEL	2001-2003
FREIGHTLINER	FL112	DETROIT DIESEL SERIE 55	1996-1997	INTERNATIONAL/NAVISTAR	9200I	CUMMINS ISM DIESEL	2001-2002
FREIGHTLINER	FLC	CATERPILLAR 3406 DIESEL	1990-1990	INTERNATIONAL/NAVISTAR	9900I	CATERPILLAR C15 DIESEL	2001-2001
FREIGHTLINER	FLC	DETROIT DIESEL SERIE 60	1990-1997	INTERNATIONAL/NAVISTAR	9900I	CUMMINS ISM DIESEL	2001-2003
FREIGHTLINER	FLD	CATERPILLAR C15 DIESEL	2002-2002	INTERNATIONAL/NAVISTAR	PAYSTAR	CATERPILLAR C12 DIESEL	2000-2000
FREIGHTLINER	FLD	CUMMINS ISM DIESEL	2002-2002	INTERNATIONAL/NAVISTAR	PAYSTAR	CUMMINS L10 DIESEL	1992-1997
FREIGHTLINER	FLD	DETROIT DIESEL SERIE 60	1990-1996	INTERNATIONAL/NAVISTAR	PAYSTAR	CUMMINS M11 DIESEL	1996-1999
FREIGHTLINER	FLD	DETROIT DIESEL SERIE 60	1997-2006	INTERNATIONAL/NAVISTAR	PAYSTAR	INTERNATIONAL/NAVISTAR 530 DIESEL	1995-1995



MASTER SERVICIO PESADO 2014

MANGUERAS

MARCA	MODELO	MOTOR	AÑOS	MARCA	MODELO	MOTOR	AÑOS
KENWORTH	K100	CUMMINS N14 DIESEL	1992-1993	KENWORTH	T2000	DETROIT DIESEL SERIE 60	1998-2000
KENWORTH	K100	DETROIT DIESEL SERIE 60	1990-1999	KENWORTH	T400	CATERPILLAR 3306 DIESEL	1990-1990
KENWORTH	T2000	CATERPILLAR C15 DIESEL	2000-2001	KENWORTH	T400	CUMMINS L10 DIESEL	1990-1994
KENWORTH	T2000	DETROIT DIESEL SERIE 60	1998-1999	KENWORTH	T450	CUMMINS M11 DIESEL	1995-1995
KENWORTH	T2000	DETROIT DIESEL SERIE 60	2000-2000	KENWORTH	T600	CUMMINS L10 DIESEL	1990-1994
KENWORTH	T450	CATERPILLAR 3306 DIESEL	1990-1990	KENWORTH	T600	CUMMINS N14 DIESEL	1997-2001
KENWORTH	T600	CATERPILLAR C15 DIESEL	2000-2008	KENWORTH	T600	CUMMINS SIGNATURE 600 DIESEL	2003-2003
KENWORTH	T600	CUMMINS ISM DIESEL	2001-2002	KENWORTH	T600	DETROIT DIESEL SERIE 60	1990-1999
KENWORTH	T600	CUMMINS N14 DIESEL	1997-2001	KENWORTH	T800	CUMMINS ISM DIESEL	1999-2002
KENWORTH	T600	CUMMINS SIGNATURE 600 DIESEL	2003-2003	KENWORTH	T800	CUMMINS L10 DIESEL	1990-1994
KENWORTH	T600	DETROIT DIESEL SERIE 60	1990-1999	KENWORTH	T800	DETROIT DIESEL 6 CIL, 11.1 L DIESEL	2000-2001
KENWORTH	T800	CUMMINS M11 DIESEL	2000-2000	KENWORTH	W900	CATERPILLAR 3406 DIESEL	1990-1990
KENWORTH	T800	DETROIT DIESEL 6 CIL, 11.1 L DIESEL	2000-2001	KENWORTH	W900	CATERPILLAR C12 DIESEL	2001-2001
KENWORTH	T800	DETROIT DIESEL 6 CIL, 12.7 L DIESEL	2000-2001	KENWORTH	W900	CUMMINS N14 DIESEL	1992-2003
KENWORTH	T800	DETROIT DIESEL SERIE 60	1990-1999	KENWORTH	W900	DETROIT DIESEL 6 CIL, 12.7 L DIESEL	2001-2001
KENWORTH	T800	DETROIT DIESEL SERIE 60	1990-1999	KENWORTH	W900	DETROIT DIESEL SERIE 60	1990-1999
KENWORTH	W900	CATERPILLAR C12 DIESEL	2001-2001	MACK	CH SERIES	CUMMINS SIGNATURE 600 DIESEL	2001-2003
KENWORTH	W900	DETROIT DIESEL 6 CIL, 12.7 L DIESEL	2001-2001	MACK	CL SERIES	CUMMINS SIGNATURE 600 DIESEL	2001-2003
KENWORTH	W900	DETROIT DIESEL SERIE 60	2000-2000	MACK	DM SERIES	MACK 6 CIL, 12.0 L DIESEL	2001-2001
STERLING	A-LINE	CATERPILLAR C16 DIESEL	2000-2000	STERLING	A-LINE	CATERPILLAR C16 DIESEL	2000-2000
STERLING	L-LINE	CUMMINS ISC DIESEL	2000-2003	STERLING	L-LINE	CUMMINS ISB DIESEL	2000-2000
DINA	S-700	CUMMINS 350	1990-1997	STERLING	SILVER STAR	CATERPILLAR 3406 DIESEL	1999-2000
DINA	S-700	CUMMINS 400	1990-1997	STERLING	SILVER STAR	CUMMINS SIGNATURE 600 DIESEL	2001-2001
FREIGHTLINER	CENTURY CLASS	CUMMINS ISM DIESEL	2001-2001	STERLING	SILVER STAR	DETROIT DIESEL SERIE 60	2000-2000
FREIGHTLINER	CLASSIC XL	CUMMINS ISM DIESEL	2002-2003	VOLVO	VNL 64T	DETROIT DIESEL SERIE 60	1999-2000
FREIGHTLINER	CLASSIC XL	CUMMINS N14 DIESEL	2002-2003	VOLVO	VNM	CATERPILLAR 3406 DIESEL	1997-1999
FREIGHTLINER	CORONADO	CATERPILLAR C16 DIESEL	2002-2003	VOLVO	VNM	DETROIT DIESEL SERIE 60	1998-2000
FREIGHTLINER	CORONADO	DETROIT DIESEL 6 CIL, 14.0 L DIESEL	2003-2003	FREIGHTLINER	CENTURY CLASS	CUMMINS N14 DIESEL	1998-2001
FREIGHTLINER	FL112	CATERPILLAR C10 DIESEL	2002-2004	FREIGHTLINER	CENTURY CLASS	DETROIT DIESEL SERIE 60	1998-2003
FREIGHTLINER	FL112	CATERPILLAR C12 DIESEL	2003-2003	FREIGHTLINER	CLASSIC	CATERPILLAR C15 DIESEL	2002-2002
FREIGHTLINER	FLD	CATERPILLAR C12 DIESEL	2002-2003	FREIGHTLINER	CLASSIC	CATERPILLAR C16 DIESEL	2002-2002
FREIGHTLINER	FLD	CUMMINS ISM DIESEL	2002-2003	FREIGHTLINER	CLASSIC	CUMMINS N14 DIESEL	2002-2002
FREIGHTLINER	FLD	CUMMINS ISM DIESEL	2002-2003	FREIGHTLINER	COLUMBIA	CUMMINS ISM DIESEL	2001-2001
FREIGHTLINER	FLD	CUMMINS L10 DIESEL	1990-1993	FREIGHTLINER	COLUMBIA	DETROIT DIESEL SERIE 60	2001-2003
FREIGHTLINER	FLD	CUMMINS N14 DIESEL	2002-2003	FREIGHTLINER	COLUMBIA	DETROIT DIESEL SERIE 60	2004-2005
FREIGHTLINER	FLD	DETROIT DIESEL SERIE 60	1997-2004	FREIGHTLINER	COLUMBIA	DETROIT DIESEL SERIE 60	2006-2006
INTERNATIONAL/NAVISTAR	5000	CATERPILLAR C10 DIESEL	1998-2000	FREIGHTLINER	CORONADO	CATERPILLAR C16 DIESEL	2002-2003
INTERNATIONAL/NAVISTAR	5000	CATERPILLAR C12 DIESEL	1998-2000	FREIGHTLINER	CORONADO	DETROIT DIESEL 6 CIL, 14.0 L DIESEL	2003-2003
INTERNATIONAL/NAVISTAR	5900I	CATERPILLAR C10 DIESEL	2001-2002	FREIGHTLINER	FL112	DETROIT DIESEL SERIE 55	1996-1997
INTERNATIONAL/NAVISTAR	8100	CATERPILLAR 3406 DIESEL	1998-1998	FREIGHTLINER	FLC	DETROIT DIESEL SERIE 60	1990-1997
INTERNATIONAL/NAVISTAR	8100	CATERPILLAR C10 DIESEL	2000-2001	FREIGHTLINER	FLD	CATERPILLAR C10 DIESEL	2002-2003
INTERNATIONAL/NAVISTAR	9400	CATERPILLAR C15 DIESEL	2005-2005	FREIGHTLINER	FLD	CUMMINS N14 DIESEL	1997-2003
INTERNATIONAL/NAVISTAR	9900I	CATERPILLAR C16 DIESEL	2001-2001	FREIGHTLINER	FLD	DETROIT DIESEL SERIE 60	1990-2006
INTERNATIONAL/NAVISTAR	9900IX	CUMMINS ISM DIESEL	2001-2002	INTERNATIONAL/NAVISTAR	5000	CATERPILLAR C10 DIESEL	1998-2000
INTERNATIONAL/NAVISTAR	PAYSTAR	CATERPILLAR C12 DIESEL	2000-2000	INTERNATIONAL/NAVISTAR	5000	CATERPILLAR C12 DIESEL	1998-1999
INTERNATIONAL/NAVISTAR	PAYSTAR	CUMMINS N14 DIESEL	1992-1998	INTERNATIONAL/NAVISTAR	5000	CUMMINS M11 DIESEL	1996-1999
KENWORTH	T2000	CUMMINS N14 DIESEL	1998-2000	INTERNATIONAL/NAVISTAR	5600	CUMMINS ISM DIESEL	2005-2005



MASTER SERVICIO PESADO 2014

MANGUERAS

MARCA	MODELO	MOTOR	AÑOS	MARCA	MODELO	MOTOR	AÑOS
INTERNATIONAL/NAVISTAR	5600I	CATERPILLAR C12 DIESEL	2000-2002	KENWORTH	K100	DETROIT DIESEL SERIE 60	1990-1999
INTERNATIONAL/NAVISTAR	5900I	CATERPILLAR C12 DIESEL	2000-2002	KENWORTH	T2000	CATERPILLAR C15 DIESEL	2000-2001
INTERNATIONAL/NAVISTAR	8100	CATERPILLAR 3406 DIESEL	1998-1998	KENWORTH	T450	CATERPILLAR 3306 DIESEL	1990-1990
INTERNATIONAL/NAVISTAR	9100I	CUMMINS ISX DIESEL	2001-2003	KENWORTH	T600	CATERPILLAR 3406 DIESEL	1990-1990
INTERNATIONAL/NAVISTAR	9400I	CATERPILLAR C15 DIESEL	2001-2001	KENWORTH	T600	CUMMINS ISM DIESEL	2001-2002
INTERNATIONAL/NAVISTAR	9900	CUMMINS ISX DIESEL	2005-2005	KENWORTH	T800	CATERPILLAR 3306 DIESEL	1990-1990
INTERNATIONAL/NAVISTAR	9900I	CUMMINS N14 DIESEL	2003-2003	KENWORTH	T800	CATERPILLAR C15 DIESEL	2001-2004
INTERNATIONAL/NAVISTAR	9900IX	CATERPILLAR C15 DIESEL	2001-2001	KENWORTH	T800	CATERPILLAR C16 DIESEL	2001-2003
INTERNATIONAL/NAVISTAR	PAYSTAR	CUMMINS N14 DIESEL	1994-1998	KENWORTH	T800	CUMMINS ISL	2005-2005
INTERNATIONAL/NAVISTAR	PAYSTAR	INTERNATIONAL/NAVISTAR 530 DIESEL	1995-1995	KENWORTH	T800	CUMMINS ISM DIESEL	1999-2002
KENWORTH	T2000	CATERPILLAR C15 DIESEL	2000-2001	KENWORTH	T800	CUMMINS N14 DIESEL	1992-1996
KENWORTH	T2000	CATERPILLAR C16 DIESEL	2000-2001	KENWORTH	T800	CUMMINS N14 DIESEL	1998-2003
KENWORTH	T2000	CUMMINS N14 DIESEL	1998-2000	KENWORTH	T800	DETROIT DIESEL 6 CIL, 12.7 L DIESEL	2000-2001
KENWORTH	T450	CUMMINS M11 DIESEL	1995-1995	KENWORTH	W900	CATERPILLAR C12 DIESEL	2001-2001
KENWORTH	T600	CUMMINS N14 DIESEL	1992-2001	MACK	CL SERIES	CUMMINS SIGNATURE 600 DIESEL	2001-2003
KENWORTH	T800	CUMMINS ISM DIESEL	1999-2002	MACK	CL SERIES	MACK 6 CIL, 12.0 L DIESEL	2001-2001
KENWORTH	T800	CUMMINS M11 DIESEL	1995-1996	MACK	CV SERIES	MACK AI DIESEL	2005-2005
KENWORTH	T800	DETROIT DIESEL 6 CIL, 11.1 L DIESEL	2000-2001	STERLING	L-LINE	CATERPILLAR C16 DIESEL	2001-2001
KENWORTH	W900	CATERPILLAR C10 DIESEL	2001-2004	STERLING	L-LINE	CUMMINS ISC DIESEL	2000-2003
KENWORTH	W900	CUMMINS N14 DIESEL	1993-1996	VOLVO	VNL 64T	DETROIT DIESEL SERIE 60	1999-2000
KENWORTH	W900	CUMMINS N14 DIESEL	1997-2003	VOLVO	VNM	CUMMINS N14 DIESEL	1998-2003
KENWORTH	W900	DETROIT DIESEL 6 CIL, 11.1 L DIESEL	2001-2001	VOLVO	VNM	CUMMINS SIGNATURE 600 DIESEL	2003-2003
KENWORTH	W900	DETROIT DIESEL 6 CIL, 11.1 L DIESEL	2001-2001	VOLVO	VNM	DETROIT DIESEL SERIE 60	1998-2000
MACK	CH SERIES	CUMMINS SIGNATURE 600 DIESEL	2001-2003	DINA	S-700	CUMMINS L10 DIESEL	1990-1997
STERLING	SILVER STAR	CATERPILLAR 3406 DIESEL	1999-2000	FREIGHTLINER	CENTURY CLASS	CUMMINS M11 DIESEL	1996-2000
FREIGHTLINER	CENTURY CLASS	DETROIT DIESEL SERIE 60	1998-2003	FREIGHTLINER	CENTURY CLASS	DETROIT DIESEL SERIE 60	2005-2005
FREIGHTLINER	CLASSIC	CATERPILLAR C15 DIESEL	2002-2002	FREIGHTLINER	CLASSIC	DETROIT DIESEL SERIE 60	2005-2005
FREIGHTLINER	CLASSIC	CUMMINS ISM DIESEL	2002-2003	FREIGHTLINER	COLUMBIA	CATERPILLAR C15 DIESEL	2005-2005
FREIGHTLINER	CLASSIC XL	CATERPILLAR C15 DIESEL	2002-2002	FREIGHTLINER	COLUMBIA	MERCEDES-BENZ MBE 4000 DIESEL	2004-2004
FREIGHTLINER	CLASSIC XL	CUMMINS N14 DIESEL	2002-2003	FREIGHTLINER	CORONADO	DETROIT DIESEL SERIE 60	2004-2006
FREIGHTLINER	COLUMBIA	CUMMINS ISM DIESEL	2001-2001	FREIGHTLINER	FLC	CUMMINS M11 DIESEL	1995-1997
FREIGHTLINER	COLUMBIA	MERCEDES-BENZ MBE 4000 DIESEL	2004-2004	FREIGHTLINER	FLC	CUMMINS N14 DIESEL	1992-1997
FREIGHTLINER	CORONADO	CATERPILLAR C15 DIESEL	2002-2004	FREIGHTLINER	FLD	CUMMINS M11 DIESEL	1995-2000
FREIGHTLINER	CORONADO	DETROIT DIESEL 6 CIL, 12.7 L DIESEL	2002-2003	INTERNATIONAL/NAVISTAR	5000	CUMMINS M11 DIESEL	1996-1999
FREIGHTLINER	FL112	CATERPILLAR C12 DIESEL	2002-2003	INTERNATIONAL/NAVISTAR	5000	CUMMINS N14 DIESEL	1992-1998
FREIGHTLINER	FLC	CUMMINS N14 DIESEL	1992-1997	INTERNATIONAL/NAVISTAR	5500	CUMMINS ISM DIESEL	2005-2005
FREIGHTLINER	FLD	CATERPILLAR C12 DIESEL	2002-2003	INTERNATIONAL/NAVISTAR	5500I	CATERPILLAR C10 DIESEL	2001-2002
FREIGHTLINER	FLD	CATERPILLAR C16 DIESEL	2002-2002	INTERNATIONAL/NAVISTAR	5500I	CATERPILLAR C12 DIESEL	2000-2002
FREIGHTLINER	FLD	CUMMINS L10 DIESEL	1990-1993	INTERNATIONAL/NAVISTAR	5600	CUMMINS ISM DIESEL	2005-2005
INTERNATIONAL/NAVISTAR	5000	CUMMINS N14 DIESEL	1994-1998	INTERNATIONAL/NAVISTAR	5600I	CATERPILLAR C10 DIESEL	2001-2002
INTERNATIONAL/NAVISTAR	5500I	CATERPILLAR C12 DIESEL	2000-2002	INTERNATIONAL/NAVISTAR	5900I	CATERPILLAR C10 DIESEL	2001-2002
INTERNATIONAL/NAVISTAR	5600I	CATERPILLAR C10 DIESEL	2001-2002	INTERNATIONAL/NAVISTAR	5900I	CATERPILLAR C12 DIESEL	2000-2002
INTERNATIONAL/NAVISTAR	5900I	CATERPILLAR C10 DIESEL	2001-2002	INTERNATIONAL/NAVISTAR	7500	INTERNATIONAL/NAVISTAR DT570 DIESEL	2005-2005
INTERNATIONAL/NAVISTAR	9200	CUMMINS ISX DIESEL	2005-2005	INTERNATIONAL/NAVISTAR	9200I	CUMMINS N14 DIESEL	2003-2003
INTERNATIONAL/NAVISTAR	9900I	CATERPILLAR C15 DIESEL	2001-2001	INTERNATIONAL/NAVISTAR	9400I	CUMMINS ISM DIESEL	2001-2003
INTERNATIONAL/NAVISTAR	9900I	CUMMINS ISM DIESEL	2001-2003	INTERNATIONAL/NAVISTAR	9400I	CUMMINS N14 DIESEL	2003-2003
INTERNATIONAL/NAVISTAR	9900IX	CUMMINS N14 DIESEL	2003-2003	INTERNATIONAL/NAVISTAR	9900IX	CATERPILLAR C16 DIESEL	2001-2001



MASTER SERVICIO PESADO 2014

MANGUERAS

MARCA	MODELO	MOTOR	AÑOS	MARCA	MODELO	MOTOR	AÑOS
INTERNATIONAL/NAVISTAR	PAYSTAR	CATERPILLAR C10 DIESEL	2000-2000	INTERNATIONAL/NAVISTAR	PAYSTAR	CATERPILLAR C10 DIESEL	2000-2000
KENWORTH	K100	CATERPILLAR 3406 DIESEL	1990-1990	INTERNATIONAL/NAVISTAR	PAYSTAR	CUMMINS M11 DIESEL	1996-1999
KENWORTH	T2000	CATERPILLAR C15 DIESEL	2000-2001	INTERNATIONAL/NAVISTAR	PAYSTAR	CUMMINS N14 DIESEL	1992-1993
KENWORTH	T2000	CATERPILLAR C16 DIESEL	2000-2001	KENWORTH	T400	CATERPILLAR 3306 DIESEL	1990-1990
KENWORTH	T450	CUMMINS L10 DIESEL	1990-1994	KENWORTH	T400	CUMMINS L10 DIESEL	1990-1994
KENWORTH	T450	CUMMINS L10 DIESEL	1990-1994	KENWORTH	T600	CUMMINS ISM DIESEL	2001-2002
KENWORTH	T600	CATERPILLAR C15 DIESEL	2000-2008	KENWORTH	T600	CUMMINS L10 DIESEL	1990-1994
KENWORTH	T600	CUMMINS ISM DIESEL	2001-2002	KENWORTH	T800	CATERPILLAR 3306 DIESEL	1990-1990
KENWORTH	T600	CUMMINS M11 DIESEL	1995-1996	KENWORTH	T800	CATERPILLAR C15 DIESEL	2001-2004
KENWORTH	T600	CUMMINS N14 DIESEL	1992-1996	KENWORTH	T800	CUMMINS ISM DIESEL	1999-2002
KENWORTH	T800	CATERPILLAR 3406 DIESEL	1990-1990	KENWORTH	T800	CUMMINS L10 DIESEL	1990-1994
KENWORTH	T800	CUMMINS M11 DIESEL	2000-2000	KENWORTH	W900	CATERPILLAR C12 DIESEL	2001-2001
KENWORTH	T800	CUMMINS N14 DIESEL	1992-2003	KENWORTH	W900	CUMMINS N14 DIESEL	1997-2003
KENWORTH	W900	CATERPILLAR C10 DIESEL	2001-2004	KENWORTH	W900	DETROIT DIESEL 6 CIL, 11.1 L DIESEL	2001-2001
KENWORTH	W900	DETROIT DIESEL 6 CIL, 11.1 L DIESEL	2001-2001	KENWORTH	W900	DETROIT DIESEL 6 CIL, 12.7 L DIESEL	2001-2001
KENWORTH	W900	DETROIT DIESEL SERIE 60	2000-2000	KENWORTH	W900	DETROIT DIESEL SERIE 60	1990-2000
MACK	CL SERIES	CUMMINS SIGNATURE 600 DIESEL	2001-2003	MACK	CH SERIES	CUMMINS SIGNATURE 600 DIESEL	2001-2003
STERLING	L-LINE	CATERPILLAR C16 DIESEL	2001-2001	MACK	CL SERIES	MACK 6 CIL, 12.0 L DIESEL	2001-2001
STERLING	SILVER STAR	CATERPILLAR C15 DIESEL	2000-2000	MACK	DM SERIES	MACK 6 CIL, 12.0 L DIESEL	2001-2001
DINA	S-700	CUMMINS 350	1990-1997	STERLING	A-LINE	CATERPILLAR C15 DIESEL	2000-2001
DINA	S-700	CUMMINS 400	1990-1997	STERLING	L-LINE	CUMMINS ISB DIESEL	2000-2000
FREIGHTLINER	CENTURY CLASS	CUMMINS N14 DIESEL	1998-2001	STERLING	L-LINE	CUMMINS ISC DIESEL	2000-2003
FREIGHTLINER	CLASSIC	CATERPILLAR C16 DIESEL	2002-2002	STERLING	SILVER STAR	CATERPILLAR 3406 DIESEL	1999-2000
FREIGHTLINER	CLASSIC	CUMMINS ISM DIESEL	2002-2002	STERLING	SILVER STAR	DETROIT DIESEL SERIE 60	2000-2000
FREIGHTLINER	CLASSIC	DETROIT DIESEL SERIE 60	2005-2005	VOLVO	VNL 64T	DETROIT DIESEL SERIE 60	1999-2000
FREIGHTLINER	CLASSIC XL	CUMMINS ISM DIESEL	2002-2003	VOLVO	VNM	CATERPILLAR 3406 DIESEL	1997-1998
FREIGHTLINER	CLASSIC XL	CUMMINS ISM DIESEL	2002-2003	VOLVO	VNM	CUMMINS ISM DIESEL	2003-2003
FREIGHTLINER	CLASSIC XL	CUMMINS N14 DIESEL	2002-2003	VOLVO	VNM	CUMMINS ISX DIESEL	2002-2003
FREIGHTLINER	CORONADO	CATERPILLAR C15 DIESEL	2002-2004	VOLVO	VNM	CUMMINS N14 DIESEL	1998-2003
FREIGHTLINER	CORONADO	DETROIT DIESEL 6 CIL, 14.0 L DIESEL	2003-2003	VOLVO	VNM	DETROIT DIESEL SERIE 60	1998-2000
FREIGHTLINER	FL112	CATERPILLAR C10 DIESEL	2003-2004			CHAPTER 2 1/4"	
FREIGHTLINER	FL112	CUMMINS ISM DIESEL	2002-2003	FREIGHTLINER	FLD	CUMMINS M11 DIESEL	1999-1999
FREIGHTLINER	FLC	CUMMINS L10 DIESEL	1990-1993	INTERNATIONAL/NAVISTAR	5000	CUMMINS M11 DIESEL	2000-2000
FREIGHTLINER	FLD	CATERPILLAR C10 DIESEL	2002-2003	INTERNATIONAL/NAVISTAR	PAYSTAR	CUMMINS L10 DIESEL	1992-1997
FREIGHTLINER	FLD	CUMMINS ISM DIESEL	2002-2003	INTERNATIONAL/NAVISTAR	PAYSTAR	CUMMINS M11 DIESEL	2000-2000
FREIGHTLINER	FLD	CUMMINS ISX DIESEL	1999-2001	FREIGHTLINER	FLD	CUMMINS L10 DIESEL	1990-1993
FREIGHTLINER	FLD	CUMMINS N14 DIESEL	1997-2003	VOLVO	VNM	CUMMINS ISM DIESEL	2003-2003
INTERNATIONAL/NAVISTAR	5000	CUMMINS L10 DIESEL	1992-1993	INTERNATIONAL/NAVISTAR	PAYSTAR	CUMMINS L10 DIESEL	1994-1997
INTERNATIONAL/NAVISTAR	5500I	CATERPILLAR C10 DIESEL	2001-2002	KENWORTH	T450	CUMMINS L10 DIESEL	1990-1994
INTERNATIONAL/NAVISTAR	7500	INTERNATIONAL/NAVISTAR DT570 DIESEL	2005-2005	KENWORTH	W900	CUMMINS N14 DIESEL	1992-1993
INTERNATIONAL/NAVISTAR	7500	INTERNATIONAL/NAVISTAR HT570	2006-2006	DINA	AVANTE	DETROIT DIESEL V6	1990-1992
INTERNATIONAL/NAVISTAR	8100	CATERPILLAR C10 DIESEL	2001-2001	DINA	AVANTE	DETROIT DIESEL V8	1990-1992
INTERNATIONAL/NAVISTAR	9000	CUMMINS ISM DIESEL	2004-2004	FREIGHTLINER	CENTURY CLASS	CUMMINS M11 DIESEL	1996-2000
INTERNATIONAL/NAVISTAR	9000	CUMMINS ISX DIESEL	2004-2004	FREIGHTLINER	FLD	CUMMINS M11 DIESEL	1995-1999
INTERNATIONAL/NAVISTAR	9400I	CATERPILLAR C16 DIESEL	2001-2001	INTERNATIONAL/NAVISTAR	5000	CUMMINS N14 DIESEL	1992-2000
INTERNATIONAL/NAVISTAR	9900	CATERPILLAR C15 DIESEL	2005-2005	KENWORTH	K100	CUMMINS N14 DIESEL	1992-1993
INTERNATIONAL/NAVISTAR	9900I	CATERPILLAR C16 DIESEL	2001-2001	KENWORTH	T800	CUMMINS ISL	2005-2005



MASTER SERVICIO PESADO 2014

MANGUERAS

MARCA	MODELO	MOTOR	AÑOS	MARCA	MODELO	MOTOR	AÑOS
VOLVO	VNM	CUMMINS ISM DIESEL	2003-2003	FREIGHTLINER	FLD	CATERPILLAR C16 DIESEL	2002-2002
FREIGHTLINER	COLUMBIA	CUMMINS ISM DIESEL	2001-2001	FREIGHTLINER	FLD	CUMMINS N14 DIESEL	1992-2001
FREIGHTLINER	FLD	CUMMINS M11 DIESEL	1999-1999	KENWORTH	K100	CUMMINS N14 DIESEL	1992-1993
INTERNATIONAL/NAVISTAR	5000	CUMMINS N14 DIESEL	1999-2000	KENWORTH	K100	DETROIT DIESEL SERIE 60	1994-1999
INTERNATIONAL/NAVISTAR	PAYSTAR	INTERNATIONAL/NAVISTAR 530 DIESEL	1995-1995	KENWORTH	T600	CATERPILLAR C15 DIESEL	2000-2008
FREIGHTLINER	CENTURY CLASS	CUMMINS ISM DIESEL	2001-2001	KENWORTH	T800	CATERPILLAR C15 DIESEL	2001-2004
INTERNATIONAL/NAVISTAR	5000	CUMMINS M11 DIESEL	2000-2000	KENWORTH	T800	CATERPILLAR C16 DIESEL	2001-2003
INTERNATIONAL/NAVISTAR	PAYSTAR	CUMMINS M11 DIESEL	2000-2000	KENWORTH	T800	CUMMINS N14 DIESEL	1993-2001
INTERNATIONAL/NAVISTAR	PAYSTAR	CUMMINS N14 DIESEL	1992-2000	DINA	AVANTE	DETROIT DIESEL V6	1990-1992
KENWORTH	T400	CUMMINS L10 DIESEL	1990-1994	DINA	AVANTE	DETROIT DIESEL V8	1990-1992
KENWORTH	T600	CUMMINS L10 DIESEL	1990-1994	FREIGHTLINER	CLASSIC	CUMMINS N14 DIESEL	2002-2002
KENWORTH	T800	CUMMINS L10 DIESEL	1990-1994	FREIGHTLINER	FLD	CATERPILLAR C16 DIESEL	2002-2002
FREIGHTLINER	FLC	CUMMINS M11 DIESEL	1995-1997	KENWORTH	K100	CATERPILLAR 3406 DIESEL	1990-1990
INTERNATIONAL/NAVISTAR	5000	CUMMINS L10 DIESEL	1994-1997	KENWORTH	T600	CATERPILLAR 3406 DIESEL	1990-1990
KENWORTH	T800	CUMMINS ISL	2005-2005	KENWORTH	T800	CATERPILLAR 3406 DIESEL	1990-1990
MACK	CV SERIES	MACK AI DIESEL	2005-2005	KENWORTH	W900	CUMMINS N14 DIESEL	1992-1993
FREIGHTLINER	FLC	CUMMINS L10 DIESEL	1990-1993	STERLING	SILVER STAR	CATERPILLAR C15 DIESEL	2000-2000
INTERNATIONAL/NAVISTAR	5000	CUMMINS L10 DIESEL	1992-1997	FREIGHTLINER	CLASSIC	CATERPILLAR C15 DIESEL	2002-2002
INTERNATIONAL/NAVISTAR	PAYSTAR	CUMMINS N14 DIESEL	1999-2000	FREIGHTLINER	CLASSIC XL	CATERPILLAR C15 DIESEL	2002-2002
CHARTER 2 3/4"				FREIGHTLINER	CLASSIC XL	CATERPILLAR C16 DIESEL	2002-2002
INTERNATIONAL/NAVISTAR	7500	INTERNATIONAL/NAVISTAR HT570	2006-2006	FREIGHTLINER	FLD	CATERPILLAR C15 DIESEL	2002-2002
INTERNATIONAL/NAVISTAR	7500	INTERNATIONAL/NAVISTAR DT570 DIESEL	2005-2005	FREIGHTLINER	FLD	CUMMINS N14 DIESEL	2002-2003
VOLVO	VNM	CUMMINS ISX DIESEL	2004-2005	FREIGHTLINER	FLD	DETROIT DIESEL SERIE 60	1990-1998
CHARTER 2"				INTERNATIONAL/NAVISTAR	9900IX	CATERPILLAR 3406 DIESEL	2000-2000
FREIGHTLINER	FLD	CUMMINS N14 DIESEL	1992-1996	KENWORTH	T450	CUMMINS M11 DIESEL	1995-1995
STERLING	L-LINE	CUMMINS ISB DIESEL	2000-2000	KENWORTH	T600	CATERPILLAR C15 DIESEL	2000-2008
KENWORTH	T800	CUMMINS ISL	2005-2005	KENWORTH	T800	CATERPILLAR C16 DIESEL	2001-2003
MACK	CV SERIES	MACK AI DIESEL	2005-2005	KENWORTH	T800	CUMMINS M11 DIESEL	1995-1996
MERCEDES BENZ	0371 RS	OM 355	1990-1998	KENWORTH	W900	CUMMINS N14 DIESEL	1992-1993
MERCEDES BENZ	0371 RS	OM 447	1990-1998	STERLING	SILVER STAR	CATERPILLAR 3406 DIESEL	1999-2000
FREIGHTLINER	FLC	CUMMINS N14 DIESEL	1992-1997	FREIGHTLINER	CLASSIC	CATERPILLAR C16 DIESEL	2002-2002
MACK	CV SERIES	MACK AI DIESEL	2005-2005	FREIGHTLINER	CLASSIC	CUMMINS ISM DIESEL	2001-2003
CHARTER 3 1/2"				FREIGHTLINER	FLC	DETROIT DIESEL SERIE 60	1990-1997
FREIGHTLINER	FLD	DETROIT DIESEL SERIE 60	1997-1997	INTERNATIONAL/NAVISTAR	9400I	CATERPILLAR 3406 DIESEL	2000-2000
CHARTER 3 1/4"				KENWORTH	T400	CUMMINS L10 DIESEL	1990-1994
KENWORTH	T800	CUMMINS ISL	2005-2006	KENWORTH	T600	CUMMINS M11 DIESEL	1995-1996
CHARTER 3"				KENWORTH	T800	CUMMINS L10 DIESEL	1990-1994
FREIGHTLINER	CLASSIC	CATERPILLAR C15 DIESEL	2002-2002	FREIGHTLINER	CENTURY CLASS	DETROIT DIESEL SERIE 60	1998-1998
FREIGHTLINER	CLASSIC XL	CUMMINS N14 DIESEL	2002-2003	FREIGHTLINER	CLASSIC	CATERPILLAR C16 DIESEL	2002-2002
FREIGHTLINER	FLD	CATERPILLAR C10 DIESEL	1997-1997	FREIGHTLINER	CLASSIC XL	CATERPILLAR C16 DIESEL	2002-2002
FREIGHTLINER	FLD	CATERPILLAR C12 DIESEL	1996-1997	FREIGHTLINER	CLASSIC XL	CUMMINS ISM DIESEL	2002-2003
FREIGHTLINER	FLD	DETROIT DIESEL SERIE 60	1999-2001	FREIGHTLINER	FLD	CUMMINS ISM DIESEL	2002-2003
INTERNATIONAL/NAVISTAR	9400	CATERPILLAR 3406 DIESEL	1999-1999	INTERNATIONAL/NAVISTAR	9900	CATERPILLAR 3406 DIESEL	1999-1999
INTERNATIONAL/NAVISTAR	9400	CATERPILLAR C15 DIESEL	2005-2005	KENWORTH	T600	CUMMINS L10 DIESEL	1990-1994
KENWORTH	W900	DETROIT DIESEL SERIE 60	1994-1999	KENWORTH	T600	DETROIT DIESEL SERIE 60	1994-1999
FREIGHTLINER	CLASSIC XL	CATERPILLAR C15 DIESEL	2002-2002	KENWORTH	T800	DETROIT DIESEL 6 CIL, 11.1 L DIESEL	2000-2001
FREIGHTLINER	FLD	CATERPILLAR C15 DIESEL	2002-2002	KENWORTH	W900	CATERPILLAR 3406 DIESEL	1990-1990



MASTER SERVICIO PESADO 2014

MANGUERAS

MARCA	MODELO	MOTOR	AÑOS	MARCA	MODELO	MOTOR	AÑOS
MACK	CH SERIES	CUMMINS SIGNATURE 600 DIESEL	2001-2003	MACK	CS SERIES	MACK AC DIESEL	2003-2003
VOLVO	VNM	CATERPILLAR 3406 DIESEL	1997-1999	MACK	CV SERIES	MACK 6 CIL, 12.0 L DIESEL	2001-2002
FREIGHTLINER	FLC	CUMMINS N14 DIESEL	1992-1997	MACK	CV SERIES	MACK AMI DIESEL	2003-2004
KENWORTH	K100	CUMMINS N14 DIESEL	1992-1993	MACK	CX SERIES	MACK 6 CIL, 12.0 L DIESEL	2001-2002
KENWORTH	T450	CUMMINS L10 DIESEL	1990-1994	STERLING	ACTERRA	CUMMINS ISB-07 DIESEL	2008-2008
KENWORTH	T600	CUMMINS N14 DIESEL	1993-2001	STERLING	ACTERRA	MERCEDES-BENZ MBE 900 DIESEL	2005-2005
INTERNATIONAL/NAVISTAR	9900	CATERPILLAR C15 DIESEL	2005-2005	FORD	F-650 SUPER DUTY	CUMMINS ISB DIESEL	2000-2004
INTERNATIONAL/NAVISTAR	9900I	CATERPILLAR 3406 DIESEL	2000-2000	FORD	F-750 SUPER DUTY	CUMMINS ISB DIESEL	2000-2004
KENWORTH	T600	CUMMINS SIGNATURE 600 DIESEL	2003-2003	FREIGHTLINER	BUSINESS CLASS M2	CATERPILLAR 3126 DIESEL	2007-2007
KENWORTH	T800	CATERPILLAR C15 DIESEL	2001-2004	FREIGHTLINER	BUSINESS CLASS M2	MERCEDES-BENZ MBE 900 DIESEL	2006-2007
KENWORTH	T800	DETROIT DIESEL 6 CIL, 12.7 L DIESEL	2000-2001	KENWORTH	K300	CUMMINS C Series 8.3 L DIESEL	1993-1994
KENWORTH	T800	DETROIT DIESEL SERIE 60	1994-1999	MACK	CH SERIES	MACK AC DIESEL	2003-2006
MACK	CL SERIES	CUMMINS SIGNATURE 600 DIESEL	2001-2003	MACK	CV SERIES	MACK 6 CIL, 12.0 L DIESEL	2001-2002
CHARTER 3/4"				MACK	CX SERIES	MACK 6 CIL, 12.0 L DIESEL	2001-2002
FREIGHTLINER	FLD	CUMMINS L10 DIESEL	1990-1993	MACK	CX SERIES	MACK AC DIESEL	2003-2006
KENWORTH	T600	DETROIT DIESEL SERIE 60	1994-1999	STERLING	ACTERRA	CUMMINS ISC DIESEL	2008-2008
KENWORTH	K100	DETROIT DIESEL SERIE 60	1994-1999	FORD	F-750 SUPER DUTY	CUMMINS ISB DIESEL	2000-2004
FREIGHTLINER	CENTURY CLASS	DETROIT DIESEL SERIE 60	1998-1998	FREIGHTLINER	BUSINESS CLASS M2	CUMMINS ISB-07 DIESEL	2008-2008
FREIGHTLINER	FLD	CUMMINS N14 DIESEL	1992-1997	FREIGHTLINER	BUSINESS CLASS M2	MERCEDES BENZ MBE 900 DIESEL	2008-2008
FREIGHTLINER	FLD	DETROIT DIESEL SERIE 60	1990-1998	FREIGHTLINER	BUSINESS CLASS M2	MERCEDES-BENZ MBE 900 DIESEL	2006-2007
FREIGHTLINER	FLC	CUMMINS N14 DIESEL	1992-1997	KENWORTH	C500	CATERPILLAR C16 DIESEL	2000-2000
FREIGHTLINER	FLC	DETROIT DIESEL SERIE 60	1990-1997	KENWORTH	T370	PACCAR PX-6	2012-2013
FREIGHTLINER	FLC	CUMMINS L10 DIESEL	1990-1993	KENWORTH	T600	CATERPILLAR 3176 DIESEL	1991-1993
KENWORTH	W900	DETROIT DIESEL SERIE 60	1994-1999	KENWORTH	T800	CUMMINS ISL DIESEL	2001-2009
KENWORTH	T800	DETROIT DIESEL SERIE 60	1994-1999	MACK	CV SERIES	MACK AMI DIESEL	2005-2005
SIH1000100HH				STERLING	L-LINE	CATERPILLAR 3126 DIESEL	2000-2001
MERCEDES BENZ	BOXER	MB 904	2005-2010	FORD	F-600	CUMMINS C Series 8.3 L DIESEL	1993-1994
SIH1750200HH				FORD	F-750 SUPER DUTY	CATERPILLAR 3126 DIESEL	2000-2004
MERCEDES BENZ	BOXER	MB 904	2005-2010	FORD	F-750 SUPER DUTY	FORD V8, 7.3 L DIESEL	2000-2004
SIH175363C				FREIGHTLINER	BUSINESS CLASS M2	CUMMINS ISC DIESEL	2004-2011
KENWORTH	T370	PACCAR PX-6	2009-2013	FREIGHTLINER	FLC	CATERPILLAR 3176 DIESEL	1991-1995
KENWORTH	T300	PACCAR PX-6 DIESEL	2007-2010	FREIGHTLINER	FLC	CUMMINS N14 DIESEL	1991-1998
SIH200363C				INTERNATIONAL/NAVISTAR	9200	CATERPILLAR 3176 DIESEL	1995-1995
FORD	F-650 SUPER DUTY	CATERPILLAR 3126 DIESEL	2000-2004	INTERNATIONAL/NAVISTAR	9300	CATERPILLAR 3176 DIESEL	1995-1995
FORD	F-650 SUPER DUTY	CATERPILLAR C7 DIESEL	2004-2006	KENWORTH	C500	CATERPILLAR 3176 DIESEL	1992-1993
KENWORTH	T400	CATERPILLAR 3176 DIESEL	1991-1993	KENWORTH	T300	CATERPILLAR 3126 DIESEL	1996-2003
KENWORTH	T800	CATERPILLAR 3176 DIESEL	1991-1993	MACK	CH SERIES	MACK 6 CIL, 12.0 L DIESEL	2001-2002
MACK	CV SERIES	MACK AI DIESEL	2003-2003	MACK	CV SERIES	MACK AI DIESEL	2003-2007
MACK	CV SERIES	MACK AMI DIESEL	2003-2003	MACK	RD SERIES	MACK 6 CIL, 12.0 L DIESEL	2001-2001
MACK	MR SERIES	MACK 6 CIL, 12.0 L DIESEL	2001-2002	STERLING	ACTERRA	CATERPILLAR 3126 DIESEL	2001-2004
STERLING	ACTERRA	CATERPILLAR 3126 DIESEL	2001-2004	STERLING	A-LINE	CUMMINS ISM DIESEL	2000-2001
FORD	F-600	CUMMINS B Series 5.9 L DIESEL	1992-1994	FORD	F-600	CUMMINS B Series 5.9 L DIESEL	1992-1994
FORD	F-650 SUPER DUTY	CUMMINS ISB DIESEL	2000-2004	FORD	F-650 SUPER DUTY	CATERPILLAR 3126 DIESEL	2000-2001
FORD	F-750 SUPER DUTY	CATERPILLAR C7 DIESEL	2004-2006	FORD	F-650 SUPER DUTY	FORD V8, 7.3 L DIESEL	2000-2004
FREIGHTLINER	FLD	CATERPILLAR 3176 DIESEL	1991-1995	FREIGHTLINER	BUSINESS CLASS M2	CUMMINS ISB DIESEL	2007-2007
FREIGHTLINER	FLD	CUMMINS N14 DIESEL	1991-1996	INTERNATIONAL/NAVISTAR	9400	CATERPILLAR 3176 DIESEL	1995-1997
INTERNATIONAL/NAVISTAR	9200	CATERPILLAR 3176 DIESEL	1995-1995	KENWORTH	K100	CUMMINS C Series 8.3 L DIESEL	1992-1993



MASTER SERVICIO PESADO 2014

MANGUERAS

MARCA	MODELO	MOTOR	AÑOS	MARCA	MODELO	MOTOR	AÑOS
KENWORTH	T450	CATERPILLAR 3176 DIESEL	1991-1993	INTERNATIONAL/NAVISTAR	7700	CUMMINS ISM DIESEL	2005-2006
MACK	MR SERIES	MACK 6 CIL, 12.0 L DIESEL	2001-2002	INTERNATIONAL/NAVISTAR	8100	CUMMINS ISM DIESEL	1998-1998
MACK	RD SERIES	MACK 6 CIL, 12.0 L DIESEL	2001-2001	INTERNATIONAL/NAVISTAR	8100	CUMMINS N14 DIESEL	1995-1998
STERLING	ACTERRA	MERCEDES-BENZ MBE 900 DIESEL	2006-2006	INTERNATIONAL/NAVISTAR	8200	CUMMINS ISM DIESEL	1998-1998
FORD	F-750 SUPER DUTY	CATERPILLAR 3126 DIESEL	2000-2001	INTERNATIONAL/NAVISTAR	9100	CUMMINS N14 DIESEL	1998-1998
FREIGHTLINER	BUSINESS CLASS M2	CATERPILLAR C7 DIESEL	2006-2007	INTERNATIONAL/NAVISTAR	9100	DETROIT DIESEL SERIE 60	1998-1999
FREIGHTLINER	BUSINESS CLASS M2	MERCEDES-BENZ MBE 900 DIESEL	2004-2005	INTERNATIONAL/NAVISTAR	9100I	CATERPILLAR C10 DIESEL	2000-2003
FREIGHTLINER	BUSINESS CLASS M2	MERCEDES-BENZ MBE 900 DIESEL	2002-2003	INTERNATIONAL/NAVISTAR	9200	CUMMINS N14 DIESEL	1996-1998
KENWORTH	C500	CATERPILLAR C15 DIESEL	2000-2003	INTERNATIONAL/NAVISTAR	9200	DETROIT DIESEL SERIE 60	1998-1999
STERLING	ACTERRA	CATERPILLAR C7 DIESEL	2006-2007	INTERNATIONAL/NAVISTAR	9200I	CATERPILLAR C13 DIESEL	2004-2008
STERLING	ACTERRA	CUMMINS ISB-07 DIESEL	2008-2008	INTERNATIONAL/NAVISTAR	9200I	CATERPILLAR C13 DIESEL	2004-2008
STERLING	L-LINE	CUMMINS ISM DIESEL	2000-2003	INTERNATIONAL/NAVISTAR	9300	CATERPILLAR 3176 DIESEL	1995-1995
FORD	F-600	CUMMINS B Series 5.9 L DIESEL	1992-1994	INTERNATIONAL/NAVISTAR	9400	CATERPILLAR C10 DIESEL	1996-1999
FREIGHTLINER	BUSINESS CLASS M2	CUMMINS ISB DIESEL	2007-2007	INTERNATIONAL/NAVISTAR	9400	CUMMINS M11 DIESEL	1996-1997
FREIGHTLINER	BUSINESS CLASS M2	CUMMINS ISB-07 DIESEL	2008-2008	INTERNATIONAL/NAVISTAR	9400	DETROIT DIESEL 6 CIL, 11.1 L DIESEL	1995-1996
FREIGHTLINER	BUSINESS CLASS M2	MERCEDES BENZ MBE 900 DIESEL	2008-2008	INTERNATIONAL/NAVISTAR	9400I	CATERPILLAR C12 DIESEL	2000-2003
INTERNATIONAL/NAVISTAR	9300	CATERPILLAR 3176 DIESEL	1995-1995	INTERNATIONAL/NAVISTAR	9600	CUMMINS N14 DIESEL	1996-1996
MACK	CH SERIES	MACK 6 CIL, 12.0 L DIESEL	2001-2002	INTERNATIONAL/NAVISTAR	9600	DETROIT DIESEL 6 CIL, 12.7 L DIESEL	1995-1995
MACK	CV SERIES	MACK AI DIESEL	2006-2007	INTERNATIONAL/NAVISTAR	9800	CUMMINS M11 DIESEL	1997-1997
MACK	CV SERIES	MACK AMI DIESEL	2004-2005	INTERNATIONAL/NAVISTAR	9900	CATERPILLAR C12 DIESEL	1999-1999
STERLING	L-LINE	CATERPILLAR 3126 DIESEL	2000-2001	INTERNATIONAL/NAVISTAR	9900I	CUMMINS ISX DIESEL	2003-2008
		SIH250124C90		INTERNATIONAL/NAVISTAR	9900I	DETROIT DIESEL SERIE 60	2000-2000
KENWORTH	W900	CUMMINS ISX DIESEL	2010-2013	INTERNATIONAL/NAVISTAR	9900IX	CATERPILLAR 3406 DIESEL	2000-2000
		SIH250363C		INTERNATIONAL/NAVISTAR	9900IX	CUMMINS ISM DIESEL	2000-2000
FREIGHTLINER	ARGOSY	DETROIT DIESEL 6 CIL, 11.1 L DIESEL	1999-2003	INTERNATIONAL/NAVISTAR	PROSTAR SERIES	INTERNATIONAL/NAVISTAR MAXXFORCE 13 DIESEL	2008-2010
FREIGHTLINER	ARGOSY	DETROIT DIESEL 6 CIL, 11.1 L DIESEL	1999-2003	KENWORTH	C500	CATERPILLAR C15 DIESEL	2000-2003
FREIGHTLINER	BUSINESS CLASS M2	CATERPILLAR 3126 DIESEL	2007-2007	KENWORTH	K100	CUMMINS 6 CIL, 14.0 L DIESEL	1991-1991
FREIGHTLINER	BUSINESS CLASS M2	CATERPILLAR C7 DIESEL	2005-2007	KENWORTH	K100	DETROIT DIESEL 6 CIL, 11.1 L DIESEL	1991-1996
FREIGHTLINER	CLASSIC	CUMMINS ISM DIESEL	2001-2001	KENWORTH	T2000	CATERPILLAR C15 DIESEL	2002-2010
FREIGHTLINER	CLASSIC XL	DETROIT DIESEL 6 CIL, 11.1 L DIESEL	2001-2002	KENWORTH	T2000	CATERPILLAR C16 DIESEL	2002-2003
FREIGHTLINER	COLUMBIA	CATERPILLAR C15 DIESEL	2001-2003	KENWORTH	T2000	CUMMINS N14 DIESEL	1997-2000
FREIGHTLINER	COLUMBIA	CUMMINS N14 DIESEL	2003-2003	KENWORTH	T2000	DETROIT DIESEL 6 CIL, 12.7 L DIESEL	1997-1999
FREIGHTLINER	COLUMBIA	DETROIT DIESEL 6 CIL, 12.7 L DIESEL	2000-2003	KENWORTH	T2000	DETROIT DIESEL 6 CIL, 12.7 L DIESEL	2000-2000
FREIGHTLINER	FLC	CUMMINS N14 DIESEL	1991-1998	KENWORTH	T450	CATERPILLAR 3176 DIESEL	1993-1993
FREIGHTLINER	FLD	CATERPILLAR C10 DIESEL	2004-2004	KENWORTH	T450	CUMMINS L10 DIESEL	1991-1994
FREIGHTLINER	FLD	CUMMINS N14 DIESEL	1991-1996	KENWORTH	T600	CATERPILLAR 3406 DIESEL	1993-1999
FREIGHTLINER	FLD	DETROIT DIESEL 6 CIL, 12.7 L DIESEL	1991-2004	KENWORTH	T600	CUMMINS 6 CIL, 14.0 L DIESEL	1991-1991
INTERNATIONAL/NAVISTAR	5000	CUMMINS M11 DIESEL	1996-1997	KENWORTH	T600	CUMMINS N14 DIESEL	1993-2001
INTERNATIONAL/NAVISTAR	5000	INTERNATIONAL/NAVISTAR 530 DIESEL	1995-1995	KENWORTH	T600	DETROIT DIESEL 6 CIL, 12.7 L DIESEL	1991-1999
INTERNATIONAL/NAVISTAR	5500I	CATERPILLAR C13 DIESEL	2005-2007	KENWORTH	T600	DETROIT DIESEL 6 CIL, 12.7 L DIESEL	1994-1999
INTERNATIONAL/NAVISTAR	5500I	CUMMINS ISM DIESEL	2006-2006	KENWORTH	T800	CATERPILLAR C10 DIESEL	1999-2004
INTERNATIONAL/NAVISTAR	5500I	CUMMINS N14 DIESEL	2002-2003	KENWORTH	T800	CATERPILLAR C13 DIESEL	2004-2014
INTERNATIONAL/NAVISTAR	5900I	CATERPILLAR C10 DIESEL	2000-2003	KENWORTH	T800	CUMMINS 6 CIL, 14.0 L DIESEL	1991-1991
INTERNATIONAL/NAVISTAR	5900I	CUMMINS ISX DIESEL	2005-2005	KENWORTH	T800	CUMMINS ISX DIESEL	1999-2014
INTERNATIONAL/NAVISTAR	7600	CATERPILLAR C10 DIESEL	2004-2004	KENWORTH	T800	CUMMINS M11 DIESEL	1995-1996
INTERNATIONAL/NAVISTAR	7600	CATERPILLAR C12 DIESEL	2002-2003	KENWORTH	T800	DETROIT DIESEL 6 CIL, 11.1 L DIESEL	1991-1999
INTERNATIONAL/NAVISTAR	7700	CATERPILLAR C13 DIESEL	2005-2006	KENWORTH	T800	DETROIT DIESEL 6 CIL, 11.1 L DIESEL	1994-1999



MASTER SERVICIO PESADO 2014

MANGUERAS

MARCA	MODELO	MOTOR	AÑOS	MARCA	MODELO	MOTOR	AÑOS
KENWORTH	W900	CATERPILLAR C13 DIESEL	2004-2010	INTERNATIONAL/NAVISTAR	5600I	CATERPILLAR C12 DIESEL	2003-2004
KENWORTH	W900	CATERPILLAR C13 DIESEL	2004-2010	INTERNATIONAL/NAVISTAR	5600I	CATERPILLAR C13 DIESEL	2005-2005
KENWORTH	W900	CATERPILLAR C13 DIESEL	2004-2010	INTERNATIONAL/NAVISTAR	5600I	CUMMINS ISM DIESEL	2002-2007
KENWORTH	W900	CATERPILLAR C15 DIESEL	2000-2007	INTERNATIONAL/NAVISTAR	5600I	CUMMINS ISX DIESEL	2006-2007
KENWORTH	W900	CUMMINS ISM DIESEL	2003-2006	INTERNATIONAL/NAVISTAR	7500	INTERNATIONAL/NAVISTAR HT570 DIESEL	2005-2006
KENWORTH	W900	CUMMINS N14 DIESEL	1997-2003	INTERNATIONAL/NAVISTAR	7600	CATERPILLAR C11 DIESEL	2004-2006
MACK	CV SERIES	MACK AI DIESEL	2003-2003	INTERNATIONAL/NAVISTAR	7600	CATERPILLAR C13 DIESEL	2004-2008
STERLING	A-LINE	CATERPILLAR C12 DIESEL	2000-2004	INTERNATIONAL/NAVISTAR	8100	CUMMINS ISM DIESEL	1999-2003
STERLING	A-LINE	DETROIT DIESEL 6 CIL, 14.0 L DIESEL	2004-2004	INTERNATIONAL/NAVISTAR	8200	DETROIT DIESEL 6 CIL, 11.1 L DIESEL	1995-1995
STERLING	A-LINE	DETROIT DIESEL 6 CIL, 14.0 L DIESEL	2005-2006	INTERNATIONAL/NAVISTAR	9100	CATERPILLAR 3406 DIESEL	1998-1998
STERLING	L-LINE	CATERPILLAR C10 DIESEL	2000-2004	INTERNATIONAL/NAVISTAR	9100	CATERPILLAR C10 DIESEL	1998-1998
STERLING	L-LINE	CATERPILLAR C12 DIESEL	2000-2004	INTERNATIONAL/NAVISTAR	9100	CATERPILLAR C12 DIESEL	1998-1999
STERLING	L-LINE	MERCEDES-BENZ MBE 4000 DIESEL	2007-2007	INTERNATIONAL/NAVISTAR	9200	CUMMINS M11 DIESEL	1995-1998
VOLVO	AUTOCAR	CUMMINS ISM DIESEL	2000-2001	INTERNATIONAL/NAVISTAR	9200I	CATERPILLAR C12 DIESEL	2000-2003
VOLVO	VNL	DETROIT DIESEL 6 CIL, 11.1 L DIESEL	1998-2001	INTERNATIONAL/NAVISTAR	9200I	CUMMINS ISM DIESEL	2000-2000
VOLVO	VNL	DETROIT DIESEL 6 CIL, 12.7 L DIESEL	1998-2001	INTERNATIONAL/NAVISTAR	9200I	DETROIT DIESEL SERIE 60	2000-2000
VOLVO	WG SERIES	CUMMINS ISM DIESEL	1998-2001	INTERNATIONAL/NAVISTAR	9300	CATERPILLAR C10 DIESEL	1996-1998
VOLVO	WIA SERIES	CATERPILLAR 3406 DIESEL	1996-1998	INTERNATIONAL/NAVISTAR	9300	DETROIT DIESEL 6 CIL, 11.1 L DIESEL	1995-1997
VOLVO	WIA SERIES	CUMMINS L10 DIESEL	1997-1997	INTERNATIONAL/NAVISTAR	9400	CATERPILLAR 3176 DIESEL	1995-1997
VOLVO	WIA SERIES	DETROIT DIESEL 6 CIL, 11.1 L DIESEL	1996-1998	INTERNATIONAL/NAVISTAR	9400	CUMMINS N14 DIESEL	1997-1998
FREIGHTLINER	ARGOSY	CATERPILLAR 3406 DIESEL	1999-2000	INTERNATIONAL/NAVISTAR	9400	DETROIT DIESEL 6 CIL, 12.7 L DIESEL	1995-1996
FREIGHTLINER	ARGOSY	CUMMINS ISM DIESEL	1999-1999	INTERNATIONAL/NAVISTAR	9400I	CATERPILLAR C15 DIESEL	2002-2003
FREIGHTLINER	ARGOSY	DETROIT DIESEL 6 CIL, 12.7 L DIESEL	1999-2008	INTERNATIONAL/NAVISTAR	9400I	CATERPILLAR C16 DIESEL	2000-2000
FREIGHTLINER	CENTURY CLASS	CATERPILLAR C11 DIESEL	2006-2006	INTERNATIONAL/NAVISTAR	9800	CUMMINS N14 DIESEL	1997-1999
FREIGHTLINER	CENTURY CLASS	CATERPILLAR C15 DIESEL	2001-2004	INTERNATIONAL/NAVISTAR	9800	DETROIT DIESEL SERIE 60	1997-1997
FREIGHTLINER	CENTURY CLASS	DETROIT DIESEL 6 CIL, 12.7 L DIESEL	2004-2007	INTERNATIONAL/NAVISTAR	9900	DETROIT DIESEL SERIE 60	1999-1999
FREIGHTLINER	CENTURY CLASS	DETROIT DIESEL 6 CIL, 12.7 L DIESEL	1998-2003	INTERNATIONAL/NAVISTAR	9900IX	CATERPILLAR C10 DIESEL	2000-2002
FREIGHTLINER	CLASSIC	CUMMINS ISM DIESEL	2001-2001	INTERNATIONAL/NAVISTAR	9900IX	CUMMINS ISX DIESEL	2003-2007
FREIGHTLINER	CLASSIC	DETROIT DIESEL 6 CIL, 11.1 L DIESEL	2001-2002	INTERNATIONAL/NAVISTAR	PAYSTAR 5900I	CUMMINS ISX DIESEL	2008-2008
FREIGHTLINER	CLASSIC	DETROIT DIESEL 6 CIL, 14.0 L DIESEL	2003-2008	INTERNATIONAL/NAVISTAR	WORKSTAR 7400	INTERNATIONAL/NAVISTAR MAXXFORCE 9 DIESEL	2008-2012
FREIGHTLINER	CLASSIC	DETROIT DIESEL 6 CIL, 14.0 L DIESEL	2008-2008	INTERNATIONAL/NAVISTAR	WORKSTAR 7600	CUMMINS ISM DIESEL	2008-2008
FREIGHTLINER	CLASSIC XL	CUMMINS ISM DIESEL	2001-2001	KENWORTH	C500	DETROIT DIESEL 6 CIL, 11.1 L DIESEL	1991-1994
FREIGHTLINER	CLASSIC XL	DETROIT DIESEL 6 CIL, 14.0 L DIESEL	2008-2008	KENWORTH	C500	DETROIT DIESEL 6 CIL, 11.1 L DIESEL	1994-1994
FREIGHTLINER	COLUMBIA	CATERPILLAR C11 DIESEL	2004-2004	KENWORTH	K100	CATERPILLAR 3406 DIESEL	1991-1994
FREIGHTLINER	COLUMBIA	CATERPILLAR C16 DIESEL	2001-2004	KENWORTH	K100	DETROIT DIESEL 6 CIL, 12.7 L DIESEL	1991-1996
FREIGHTLINER	COLUMBIA	CUMMINS ISX DIESEL	2001-2001	KENWORTH	T2000	CATERPILLAR C10 DIESEL	1997-1997
FREIGHTLINER	COLUMBIA	MERCEDES-BENZ MBE 4000 DIESEL	2003-2004	KENWORTH	T300	CATERPILLAR 3126 DIESEL	1996-2003
FREIGHTLINER	FL112	CATERPILLAR C10 DIESEL	1999-2001	KENWORTH	T300	CUMMINS ISC DIESEL	2005-2005
FREIGHTLINER	FLC	CUMMINS M11 DIESEL	1995-1997	KENWORTH	T300	CUMMINS ISC DIESEL	2007-2008
FREIGHTLINER	FLC	DETROIT DIESEL 6 CIL, 11.1 L DIESEL	1995-1995	KENWORTH	T370	PACCAR PX-6	2009-2013
FREIGHTLINER	FLC	DETROIT DIESEL 6 CIL, 12.7 L DIESEL	1991-1998	KENWORTH	T600	CATERPILLAR C10 DIESEL	1996-1996
FREIGHTLINER	FLD	CATERPILLAR C10 DIESEL	2001-2001	KENWORTH	T600	CUMMINS M11 DIESEL	1995-1996
FREIGHTLINER	FLD	CATERPILLAR C11 DIESEL	2005-2007	KENWORTH	T600	CUMMINS SIGNATURE 600 DIESEL	2003-2003
FREIGHTLINER	FLD	CATERPILLAR C11 DIESEL	2005-2007	KENWORTH	T660	CATERPILLAR C15 DIESEL	2007-2013
FREIGHTLINER	FLD	CUMMINS ISX DIESEL	1999-2001	KENWORTH	T660	CUMMINS ISX DIESEL	2007-2014
FREIGHTLINER	FLD	CUMMINS L10 DIESEL	1991-1993	KENWORTH	T800	CUMMINS N14 DIESEL	1998-2003
INTERNATIONAL/NAVISTAR	5000	CUMMINS ISM DIESEL	1998-2000	KENWORTH	W900	CATERPILLAR C15 DIESEL	2008-2010



MASTER SERVICIO PESADO 2014

MANGUERAS

MARCA	MODELO	MOTOR	AÑOS	MARCA	MODELO	MOTOR	AÑOS
KENWORTH	W900	CUMMINS ISX DIESEL	2010-2013	FREIGHTLINER	FLC	CUMMINS M11 DIESEL	1995-1997
KENWORTH	W900	DETROIT DIESEL 6 CIL, 11.1 L DIESEL	1994-2000	FREIGHTLINER	FLD	CATERPILLAR 3306 DIESEL	1993-1994
MACK	CT SERIES	MACK AI DIESEL	2006-2007	FREIGHTLINER	FLD	CATERPILLAR 3406 DIESEL	1995-2000
MACK	CXP SERIES	MACK MP7 DIESEL	2006-2007	FREIGHTLINER	FLD	CATERPILLAR C15 DIESEL	2005-2006
MACK	MR SERIES	MACK 6 CIL, 12.0 L DIESEL	2001-2002	FREIGHTLINER	FLD	CUMMINS ISM DIESEL	2000-2001
STERLING	A-LINE	CATERPILLAR C9 DIESEL	2004-2004	FREIGHTLINER	FLD	DETROIT DIESEL 6 CIL, 14.0 L DIESEL	2001-2004
STERLING	A-LINE	CUMMINS N14 DIESEL	2000-2003	INTERNATIONAL/NAVISTAR	5000	CUMMINS L10 DIESEL	1995-1998
STERLING	A-LINE	MERCEDES-BENZ MBE 4000 DIESEL	2004-2005	INTERNATIONAL/NAVISTAR	5600I	CATERPILLAR C10 DIESEL	2000-2000
STERLING	L-LINE	CATERPILLAR 3126 DIESEL	2000-2004	INTERNATIONAL/NAVISTAR	7400	INTERNATIONAL/NAVISTAR 570 DIESEL	2006-2006
STERLING	L-LINE	CATERPILLAR C13 DIESEL	2007-2007	INTERNATIONAL/NAVISTAR	7400	INTERNATIONAL/NAVISTAR DT570 DIESEL	2005-2007
STERLING	L-LINE	CATERPILLAR C15 DIESEL	2005-2005	INTERNATIONAL/NAVISTAR	8100	CUMMINS L10 DIESEL	1995-1997
STERLING	L-LINE	CUMMINS N14 DIESEL	2000-2003	INTERNATIONAL/NAVISTAR	8100	INTERNATIONAL/NAVISTAR DT466	1995-1995
STERLING	L-LINE	DETROIT DIESEL 6 CIL, 11.1 L DIESEL	2000-2002	INTERNATIONAL/NAVISTAR	8100	INTERNATIONAL/NAVISTAR DT466	1995-1995
STERLING	L-LINE	DETROIT DIESEL 6 CIL, 12.7 L DIESEL	2004-2004	INTERNATIONAL/NAVISTAR	8200	CUMMINS N14 DIESEL	1995-1998
STERLING	L-LINE	DETROIT DIESEL 6 CIL, 12.7 L DIESEL	2000-2008	INTERNATIONAL/NAVISTAR	8200	DETROIT DIESEL 6 CIL, 12.7 L DIESEL	1995-1995
VOLVO	VNL	CUMMINS ISM DIESEL	2001-2003	INTERNATIONAL/NAVISTAR	8600	CATERPILLAR C10 DIESEL	2003-2004
VOLVO	VNL	CUMMINS SIGNATURE 600 DIESEL	2003-2003	INTERNATIONAL/NAVISTAR	8600	CATERPILLAR C11 DIESEL	2006-2006
VOLVO	WG SERIES	CUMMINS N14 DIESEL	1996-1996	INTERNATIONAL/NAVISTAR	8600	CATERPILLAR C13 DIESEL	2005-2007
VOLVO	WIA SERIES	CUMMINS ISM DIESEL	1998-1999	INTERNATIONAL/NAVISTAR	9100I	DETROIT DIESEL 6 CIL, 12.7 L DIESEL	2001-2002
VOLVO	WIA SERIES	DETROIT DIESEL 6 CIL, 12.7 L DIESEL	1996-1998	INTERNATIONAL/NAVISTAR	9200	CATERPILLAR 3176 DIESEL	1995-1995
VOLVO	XPEDITOR	CATERPILLAR 3306 DIESEL	1996-1996	INTERNATIONAL/NAVISTAR	9200	CATERPILLAR 3406 DIESEL	1996-1998
VOLVO	XPEDITOR	CUMMINS L10 DIESEL	1996-1996	INTERNATIONAL/NAVISTAR	9200I	CATERPILLAR C16 DIESEL	2003-2003
FORD	F-600	FORD 6 CIL, 7.8 L DIESEL	1991-1991	INTERNATIONAL/NAVISTAR	9200I	DETROIT DIESEL 6 CIL, 12.7 L DIESEL	2001-2003
FREIGHTLINER	ARGOSY	CATERPILLAR C15 DIESEL	2001-2004	INTERNATIONAL/NAVISTAR	9300	CATERPILLAR 3406 DIESEL	1995-1998
FREIGHTLINER	ARGOSY	CATERPILLAR C15 DIESEL	2001-2004	INTERNATIONAL/NAVISTAR	9300	CUMMINS N14 DIESEL	1997-1999
FREIGHTLINER	ARGOSY	DETROIT DIESEL 6 CIL, 14.0 L DIESEL	2001-2008	INTERNATIONAL/NAVISTAR	9300	DETROIT DIESEL 6 CIL, 11.1 L DIESEL	1995-1997
FREIGHTLINER	BUSINESS CLASS M2	MERCEDES-BENZ MBE 900 DIESEL	2006-2007	INTERNATIONAL/NAVISTAR	9300	DETROIT DIESEL 6 CIL, 12.7 L DIESEL	1995-1997
FREIGHTLINER	CASCADIA	DETROIT DIESEL 6 CIL, 14.0 L DIESEL	2008-2010	INTERNATIONAL/NAVISTAR	9400	CATERPILLAR 3406 DIESEL	1995-1995
FREIGHTLINER	CASCADIA	DETROIT DIESEL 6 CIL, 14.0 L DIESEL	2008-2010	INTERNATIONAL/NAVISTAR	9400I	CATERPILLAR C16 DIESEL	2002-2003
FREIGHTLINER	CENTURY CLASS	CATERPILLAR 3406 DIESEL	1996-1999	INTERNATIONAL/NAVISTAR	9600	DETROIT DIESEL 6 CIL, 11.1 L DIESEL	1996-1996
FREIGHTLINER	CENTURY CLASS	CUMMINS ISM DIESEL	1999-2000	INTERNATIONAL/NAVISTAR	9700	CUMMINS N14 DIESEL	1996-1996
FREIGHTLINER	CENTURY CLASS	CUMMINS ISX DIESEL	2000-2001	INTERNATIONAL/NAVISTAR	9700	DETROIT DIESEL 6 CIL, 11.1 L DIESEL	1996-1996
FREIGHTLINER	CENTURY CLASS	DETROIT DIESEL 6 CIL, 14.0 L DIESEL	2003-2003	INTERNATIONAL/NAVISTAR	9700	DETROIT DIESEL 6 CIL, 12.7 L DIESEL	1996-1996
FREIGHTLINER	CLASSIC	CATERPILLAR C15 DIESEL	2001-2003	INTERNATIONAL/NAVISTAR	9900I	CATERPILLAR C15 DIESEL	2004-2008
FREIGHTLINER	CLASSIC	CATERPILLAR C16 DIESEL	2001-2003	INTERNATIONAL/NAVISTAR	9900I	CATERPILLAR C16 DIESEL	2002-2003
FREIGHTLINER	CLASSIC	DETROIT DIESEL 6 CIL, 12.7 L DIESEL	2001-2004	INTERNATIONAL/NAVISTAR	9900IX	CATERPILLAR C15 DIESEL	2000-2000
FREIGHTLINER	CLASSIC XL	CATERPILLAR C15 DIESEL	2001-2004	INTERNATIONAL/NAVISTAR	9900IX	CUMMINS ISX DIESEL	2000-2007
FREIGHTLINER	CLASSIC XL	DETROIT DIESEL 6 CIL, 14.0 L DIESEL	2001-2004	INTERNATIONAL/NAVISTAR	9900IX	DETROIT DIESEL SERIE 60	2000-2000
FREIGHTLINER	COLUMBIA	CUMMINS ISM DIESEL	2001-2001	INTERNATIONAL/NAVISTAR	WORKSTAR 7400	INTERNATIONAL/NAVISTAR MAXXFORCE 9 DIESEL	2008-2012
FREIGHTLINER	COLUMBIA	CUMMINS ISX DIESEL	2001-2001	KENWORTH	C500	CATERPILLAR 3176 DIESEL	1993-1993
FREIGHTLINER	COLUMBIA	DETROIT DIESEL 6 CIL, 11.1 L DIESEL	2000-2001	KENWORTH	T2000	CATERPILLAR 3406 DIESEL	1997-2000
FREIGHTLINER	CORONADO	CATERPILLAR C15 DIESEL	2005-2006	KENWORTH	T2000	CUMMINS ISX DIESEL	1999-2006
FREIGHTLINER	CORONADO	DETROIT DIESEL 6 CIL, 12.7 L DIESEL	2004-2008	KENWORTH	T2000	DETROIT DIESEL 6 CIL, 11.1 L DIESEL	2000-2000
FREIGHTLINER	FL112	CUMMINS M11 DIESEL	1996-1997	KENWORTH	T400	CATERPILLAR 3306 DIESEL	1991-1992
FREIGHTLINER	FL112	DETROIT DIESEL SERIES 55 DIESEL	1997-1997	KENWORTH	T400	CUMMINS L10 DIESEL	1991-1994
FREIGHTLINER	FL112	MERCEDES-BENZ MBE 4000 DIESEL	2003-2004	KENWORTH	T450	CATERPILLAR 3176 DIESEL	1991-1992
FREIGHTLINER	FLC	CUMMINS L10 DIESEL	1991-1993	KENWORTH	T600	CATERPILLAR C10 DIESEL	1997-2001



MASTER SERVICIO PESADO 2014

MANGUERAS

MARCA	MODELO	MOTOR	AÑOS	MARCA	MODELO	MOTOR	AÑOS
KENWORTH	T600	CATERPILLAR C12 DIESEL	1996-2001	FREIGHTLINER	CLASSIC	DETROIT DIESEL 6 CIL, 14.0 L DIESEL	2003-2004
KENWORTH	T600	CATERPILLAR C12 DIESEL	2002-2004	FREIGHTLINER	CLASSIC XL	CATERPILLAR C16 DIESEL	2001-2003
KENWORTH	T600	CUMMINS ISX DIESEL	2002-2010	FREIGHTLINER	CLASSIC XL	CUMMINS N14 DIESEL	2001-2001
KENWORTH	T600	CUMMINS L10 DIESEL	1991-1994	FREIGHTLINER	CLASSIC XL	DETROIT DIESEL 6 CIL, 12.7 L DIESEL	2001-2004
KENWORTH	T600	DETROIT DIESEL 6 CIL, 11.1 L DIESEL	1994-1999	FREIGHTLINER	COLUMBIA	CATERPILLAR C13 DIESEL	2004-2009
KENWORTH	T660	CATERPILLAR C15 DIESEL	2007-2013	FREIGHTLINER	COLUMBIA	CATERPILLAR C15 DIESEL	2005-2005
KENWORTH	T660	CUMMINS ISX DIESEL	2007-2014	FREIGHTLINER	COLUMBIA	CATERPILLAR C15 DIESEL	2001-2005
KENWORTH	T800	CATERPILLAR 3306 DIESEL	1991-1992	FREIGHTLINER	COLUMBIA	CATERPILLAR C16 DIESEL	2001-2004
KENWORTH	T800	CATERPILLAR 3406 DIESEL	1993-1999	FREIGHTLINER	COLUMBIA	DETROIT DIESEL 6 CIL, 14.0 L DIESEL	2004-2011
KENWORTH	T800	CATERPILLAR C11 DIESEL	2003-2009	FREIGHTLINER	COLUMBIA	MERCEDES-BENZ MBE 4000 DIESEL	2003-2004
KENWORTH	T800	CATERPILLAR C15 DIESEL	2000-2013	FREIGHTLINER	FLC	CUMMINS L10 DIESEL	1991-1993
KENWORTH	T800	CATERPILLAR C16 DIESEL	2000-2000	FREIGHTLINER	FLC	DETROIT DIESEL 6 CIL, 11.1 L DIESEL	1991-1998
KENWORTH	T800	CUMMINS ISM DIESEL	2003-2003	FREIGHTLINER	FLD	CATERPILLAR 3176 DIESEL	1991-1995
KENWORTH	T800	CUMMINS L10 DIESEL	1991-1994	FREIGHTLINER	FLD	CATERPILLAR C15 DIESEL	2005-2006
KENWORTH	T800	CUMMINS N14 DIESEL	2002-2003	FREIGHTLINER	FLD	CUMMINS ISM DIESEL	1998-1998
KENWORTH	T800	DETROIT DIESEL 6 CIL, 12.7 L DIESEL	1991-1999	INTERNATIONAL/NAVISTAR	5000	CUMMINS ISM DIESEL	1998-2000
KENWORTH	W900	CUMMINS ISX DIESEL	1999-2007	INTERNATIONAL/NAVISTAR	5500I	CATERPILLAR C10 DIESEL	2000-2004
KENWORTH	W900	CUMMINS SIGNATURE 600 DIESEL	2000-2002	INTERNATIONAL/NAVISTAR	5500I	CUMMINS ISM DIESEL	2002-2004
KENWORTH	W900	DETROIT DIESEL 6 CIL, 11.1 L DIESEL	2000-2000	INTERNATIONAL/NAVISTAR	5500I	CUMMINS ISX DIESEL	2003-2006
MACK	CV SERIES	MACK 6 CIL, 12.0 L DIESEL	2001-2002	INTERNATIONAL/NAVISTAR	5900I	CATERPILLAR C12 DIESEL	2003-2004
MACK	CX SERIES	MACK 6 CIL, 12.0 L DIESEL	2001-2001	INTERNATIONAL/NAVISTAR	5900I	CUMMINS ISM DIESEL	2001-2006
MACK	MR SERIES	MACK 6 CIL, 12.0 L DIESEL	2001-2002	INTERNATIONAL/NAVISTAR	5900I	CUMMINS ISX DIESEL	2003-2007
MACK	RD SERIES	MACK 6 CIL, 12.0 L DIESEL	2001-2001	INTERNATIONAL/NAVISTAR	7400	CUMMINS ISM DIESEL	2005-2005
STERLING	A-LINE	CATERPILLAR 3406 DIESEL	2000-2001	INTERNATIONAL/NAVISTAR	7500	INTERNATIONAL/NAVISTAR DT466	2002-2002
STERLING	A-LINE	CATERPILLAR C10 DIESEL	2000-2001	INTERNATIONAL/NAVISTAR	7600	CATERPILLAR C12 DIESEL	2002-2004
STERLING	A-LINE	CUMMINS ISM DIESEL	2000-2001	INTERNATIONAL/NAVISTAR	7600	CUMMINS ISM DIESEL	2003-2006
STERLING	A-LINE	CUMMINS N14 DIESEL	2000-2003	INTERNATIONAL/NAVISTAR	8100	CUMMINS ISM DIESEL	1998-1998
STERLING	A-LINE	DETROIT DIESEL 6 CIL, 11.1 L DIESEL	2000-2002	INTERNATIONAL/NAVISTAR	8100	CUMMINS N14 DIESEL	1995-1998
STERLING	A-LINE	DETROIT DIESEL 6 CIL, 12.7 L DIESEL	2000-2006	INTERNATIONAL/NAVISTAR	8200	CUMMINS L10 DIESEL	1995-1997
STERLING	L-LINE	CATERPILLAR 3406 DIESEL	2000-2001	INTERNATIONAL/NAVISTAR	8200	INTERNATIONAL/NAVISTAR 530 DIESEL	1996-1997
STERLING	L-LINE	CUMMINS ISM DIESEL	2000-2003	INTERNATIONAL/NAVISTAR	8600	CATERPILLAR C11 DIESEL	2004-2004
STERLING	L-LINE	DETROIT DIESEL 6 CIL, 14.0 L DIESEL	2003-2003	INTERNATIONAL/NAVISTAR	9200	CUMMINS M11 DIESEL	1995-1998
VOLVO	AUTOCAR	DETROIT DIESEL 6 CIL, 12.7 L DIESEL	1999-2001	INTERNATIONAL/NAVISTAR	9200I	CATERPILLAR C10 DIESEL	2004-2004
VOLVO	VNL	CUMMINS ISM DIESEL	2001-2001	INTERNATIONAL/NAVISTAR	9200I	CUMMINS ISM DIESEL	2000-2007
VOLVO	VNL	CUMMINS ISX DIESEL	2003-2003	INTERNATIONAL/NAVISTAR	9200I	CUMMINS ISX DIESEL	2003-2013
VOLVO	WG SERIES	CATERPILLAR 3306 DIESEL	1996-1996	INTERNATIONAL/NAVISTAR	9200I	DETROIT DIESEL SERIE 60	2000-2000
VOLVO	WIA SERIES	CUMMINS N14 DIESEL	1996-1998	INTERNATIONAL/NAVISTAR	9300	DETROIT DIESEL SERIE 60	1998-1998
VOLVO	WIA SERIES	DETROIT DIESEL 6 CIL, 12.7 L DIESEL	1996-1998	INTERNATIONAL/NAVISTAR	9400	CUMMINS N14 DIESEL	1997-1999
VOLVO	XPEDITOR	CUMMINS L10 DIESEL	1996-1996	INTERNATIONAL/NAVISTAR	9400	DETROIT DIESEL 6 CIL, 11.1 L DIESEL	1995-1996
FORD	F-600	FORD 6 CIL, 6.6 L DIESEL	1991-1993	INTERNATIONAL/NAVISTAR	9400	DETROIT DIESEL 6 CIL, 12.7 L DIESEL	1995-1996
FREIGHTLINER	CENTURY CLASS	CATERPILLAR C13 DIESEL	2006-2006	INTERNATIONAL/NAVISTAR	9400I	CATERPILLAR 3406 DIESEL	2000-2000
FREIGHTLINER	CENTURY CLASS	CATERPILLAR C15 DIESEL	2001-2006	INTERNATIONAL/NAVISTAR	9400I	CATERPILLAR C15 DIESEL	2000-2000
FREIGHTLINER	CENTURY CLASS	CATERPILLAR C15 DIESEL	2005-2006	INTERNATIONAL/NAVISTAR	9400I	CUMMINS ISM DIESEL	2000-2007
FREIGHTLINER	CENTURY CLASS	CUMMINS ISM DIESEL	1998-1998	INTERNATIONAL/NAVISTAR	9400I	CUMMINS ISX DIESEL	2003-2007
FREIGHTLINER	CENTURY CLASS	MERCEDES-BENZ MBE 4000 DIESEL	2004-2005	INTERNATIONAL/NAVISTAR	9400I	DETROIT DIESEL SERIE 60	2000-2000
FREIGHTLINER	CLASSIC	CUMMINS N14 DIESEL	2001-2001	INTERNATIONAL/NAVISTAR	9600	CUMMINS M11 DIESEL	1996-1996
FREIGHTLINER	CLASSIC	DETROIT DIESEL 6 CIL, 11.1 L DIESEL	2001-2002	INTERNATIONAL/NAVISTAR	9600	CUMMINS N14 DIESEL	1996-1996



MASTER SERVICIO PESADO 2014

MANGUERAS

MARCA	MODELO	MOTOR	AÑOS	MARCA	MODELO	MOTOR	AÑOS
INTERNATIONAL/NAVISTAR	9600	DETROIT DIESEL 6 CIL, 12.7 L DIESEL	1995-1995	FREIGHTLINER	CLASSIC XL	CATERPILLAR C15 DIESEL	2005-2005
INTERNATIONAL/NAVISTAR	9800	CUMMINS N14 DIESEL	1997-1999	FREIGHTLINER	CLASSIC XL	CATERPILLAR C15 DIESEL	2001-2005
INTERNATIONAL/NAVISTAR	9900	CATERPILLAR C10 DIESEL	1999-1999	FREIGHTLINER	CLASSIC XL	CATERPILLAR C16 DIESEL	2001-2003
INTERNATIONAL/NAVISTAR	9900I	CATERPILLAR C10 DIESEL	2000-2002	FREIGHTLINER	CLASSIC XL	CUMMINS N14 DIESEL	2001-2001
INTERNATIONAL/NAVISTAR	9900IX	CATERPILLAR C15 DIESEL	2004-2007	FREIGHTLINER	CLASSIC XL	DETROIT DIESEL 6 CIL, 12.7 L DIESEL	2001-2007
INTERNATIONAL/NAVISTAR	PROSTAR SERIES	CUMMINS ISX DIESEL	2007-2012	FREIGHTLINER	CORONADO	DETROIT DIESEL 6 CIL, 12.7 L DIESEL	2004-2008
KENWORTH	C500	DETROIT DIESEL 6 CIL, 12.7 L DIESEL	1994-1994	FREIGHTLINER	FL112	MERCEDES-BENZ MBE 4000 DIESEL	2003-2004
KENWORTH	T2000	CATERPILLAR C16 DIESEL	2002-2003	FREIGHTLINER	FLC	CUMMINS N14 DIESEL	1991-1998
KENWORTH	T2000	CUMMINS N14 DIESEL	1997-2000	FREIGHTLINER	FLD	CATERPILLAR 3406 DIESEL	1995-2000
KENWORTH	T2000	DETROIT DIESEL 6 CIL, 11.1 L DIESEL	1997-1999	FREIGHTLINER	FLD	CATERPILLAR C12 DIESEL	2004-2004
KENWORTH	T2000	DETROIT DIESEL 6 CIL, 12.7 L DIESEL	2000-2000	FREIGHTLINER	FLD	CUMMINS ISM DIESEL	1998-2001
KENWORTH	T450	CATERPILLAR 3306 DIESEL	1991-1996	FREIGHTLINER	FLD	CUMMINS N14 DIESEL	1991-1997
KENWORTH	T600	CUMMINS M11 DIESEL	1995-1996	FREIGHTLINER	FLD	DETROIT DIESEL 6 CIL, 14.0 L DIESEL	2001-2010
KENWORTH	T600	CUMMINS N14 DIESEL	1992-1996	INTERNATIONAL/NAVISTAR	5000	CUMMINS L10 DIESEL	1995-1998
KENWORTH	T600	CUMMINS N14 DIESEL	1997-2001	INTERNATIONAL/NAVISTAR	5500I	CATERPILLAR C10 DIESEL	2000-2000
KENWORTH	T600	CUMMINS SIGNATURE 600 DIESEL	2003-2003	INTERNATIONAL/NAVISTAR	5600I	CATERPILLAR C10 DIESEL	2000-2004
KENWORTH	T600	DETROIT DIESEL 6 CIL, 11.1 L DIESEL	1991-1999	INTERNATIONAL/NAVISTAR	5600I	CUMMINS ISX DIESEL	2005-2007
KENWORTH	T800	CATERPILLAR C10 DIESEL	1996-1998	INTERNATIONAL/NAVISTAR	5600I	CUMMINS ISX DIESEL	2005-2005
KENWORTH	T800	CUMMINS N14 DIESEL	1993-2003	INTERNATIONAL/NAVISTAR	7300	INTERNATIONAL/NAVISTAR DT466	2006-2006
KENWORTH	T800	DETROIT DIESEL 6 CIL, 12.7 L DIESEL	1994-1999	INTERNATIONAL/NAVISTAR	7400	CUMMINS ISM DIESEL	2005-2005
KENWORTH	W900	CATERPILLAR C11 DIESEL	2005-2007	INTERNATIONAL/NAVISTAR	7400	INTERNATIONAL/NAVISTAR DT466	2005-2007
MACK	CH SERIES	MACK 6 CIL, 12.0 L DIESEL	2001-2002	INTERNATIONAL/NAVISTAR	7500	INTERNATIONAL/NAVISTAR HT570 DIESEL	2005-2006
MACK	CL SERIES	CUMMINS ISX DIESEL	2004-2007	INTERNATIONAL/NAVISTAR	7700	CATERPILLAR C11 DIESEL	2005-2006
STERLING	A-LINE	CATERPILLAR C10 DIESEL	2002-2004	INTERNATIONAL/NAVISTAR	7700	CATERPILLAR C11 DIESEL	2005-2006
STERLING	A-LINE	CATERPILLAR C13 DIESEL	2004-2004	INTERNATIONAL/NAVISTAR	8100	CUMMINS L10 DIESEL	1997-1997
STERLING	A-LINE	DETROIT DIESEL 6 CIL, 14.0 L DIESEL	2005-2005	INTERNATIONAL/NAVISTAR	8100	INTERNATIONAL/NAVISTAR 530 DIESEL	1995-1997
STERLING	L-LINE	CATERPILLAR C9 DIESEL	2004-2004	INTERNATIONAL/NAVISTAR	8200	CUMMINS N14 DIESEL	1995-1998
STERLING	L-LINE	CUMMINS N14 DIESEL	2000-2003	INTERNATIONAL/NAVISTAR	8200	DETROIT DIESEL 6 CIL, 12.7 L DIESEL	1995-1995
STERLING	L-LINE	DETROIT DIESEL 6 CIL, 12.7 L DIESEL	2000-2003	INTERNATIONAL/NAVISTAR	9100I	CUMMINS N14 DIESEL	2000-2003
VOLVO	AUTOCAR	CUMMINS ISM DIESEL	2000-2001	INTERNATIONAL/NAVISTAR	9200	CATERPILLAR 3406 DIESEL	1996-1998
VOLVO	VNL	CATERPILLAR 3406 DIESEL	1997-1999	INTERNATIONAL/NAVISTAR	9200I	CATERPILLAR C15 DIESEL	2003-2004
VOLVO	VNL	CUMMINS ISM DIESEL	2003-2003	INTERNATIONAL/NAVISTAR	9200I	CUMMINS N14 DIESEL	2000-2003
VOLVO	VNL	DETROIT DIESEL 6 CIL, 12.7 L DIESEL	1998-2001	INTERNATIONAL/NAVISTAR	9300	CATERPILLAR 3406 DIESEL	1995-1998
VOLVO	WG SERIES	CUMMINS ISM DIESEL	1998-2001	INTERNATIONAL/NAVISTAR	9300	DETROIT DIESEL SERIE 60	1998-1998
VOLVO	WG SERIES	CUMMINS N14 DIESEL	1996-1996	INTERNATIONAL/NAVISTAR	9400I	CATERPILLAR 3406 DIESEL	2000-2000
VOLVO	WIA SERIES	CATERPILLAR 3406 DIESEL	1996-1998	INTERNATIONAL/NAVISTAR	9400I	CUMMINS ISM DIESEL	2000-2000
VOLVO	WIA SERIES	CUMMINS ISM DIESEL	1998-1999	INTERNATIONAL/NAVISTAR	9600	CUMMINS M11 DIESEL	1996-1996
FREIGHTLINER	ARGOSY	DETROIT DIESEL 6 CIL, 14.0 L DIESEL	2001-2008	INTERNATIONAL/NAVISTAR	9600	DETROIT DIESEL 6 CIL, 11.1 L DIESEL	1996-1996
FREIGHTLINER	BUSINESS CLASS M2	CUMMINS ISC DIESEL	2006-2006	INTERNATIONAL/NAVISTAR	9700	CUMMINS M11 DIESEL	1996-1996
FREIGHTLINER	CENTURY CLASS	CATERPILLAR 3406 DIESEL	1996-1999	INTERNATIONAL/NAVISTAR	9700	CUMMINS N14 DIESEL	1996-1996
FREIGHTLINER	CENTURY CLASS	CUMMINS ISM DIESEL	1998-2000	INTERNATIONAL/NAVISTAR	9700	DETROIT DIESEL 6 CIL, 11.1 L DIESEL	1996-1996
FREIGHTLINER	CENTURY CLASS	CUMMINS ISX DIESEL	2000-2001	INTERNATIONAL/NAVISTAR	9700	DETROIT DIESEL 6 CIL, 12.7 L DIESEL	1996-1996
FREIGHTLINER	CENTURY CLASS	DETROIT DIESEL 6 CIL, 14.0 L DIESEL	2003-2007	INTERNATIONAL/NAVISTAR	9900	CATERPILLAR 3406 DIESEL	1999-1999
FREIGHTLINER	CLASSIC	CATERPILLAR C15 DIESEL	2001-2005	INTERNATIONAL/NAVISTAR	9900I	CATERPILLAR C15 DIESEL	2002-2003
FREIGHTLINER	CLASSIC	CATERPILLAR C16 DIESEL	2001-2003	INTERNATIONAL/NAVISTAR	9900I	CATERPILLAR C16 DIESEL	2000-2000
FREIGHTLINER	CLASSIC	CUMMINS N14 DIESEL	2001-2001	INTERNATIONAL/NAVISTAR	9900I	CUMMINS N14 DIESEL	2000-2003
FREIGHTLINER	CLASSIC	DETROIT DIESEL 6 CIL, 12.7 L DIESEL	2001-2007	INTERNATIONAL/NAVISTAR	9900I	DETROIT DIESEL 6 CIL, 12.7 L DIESEL	2001-2003



MASTER SERVICIO PESADO 2014

MANGUERAS

MARCA	MODELO	MOTOR	AÑOS	MARCA	MODELO	MOTOR	AÑOS
INTERNATIONAL/NAVISTAR	PAYSTAR 5500i	CUMMINS ISX DIESEL	2008-2008	FREIGHTLINER	COLUMBIA	CATERPILLAR C11 DIESEL	2004-2004
INTERNATIONAL/NAVISTAR	WORKSTAR 7400	INTERNATIONAL/NAVISTAR MAXXFORCE 9 DIESEL	2008-2012	FREIGHTLINER	COLUMBIA	DETROIT DIESEL 6 CIL, 14.0 L DIESEL	2007-2007
KENWORTH	C500	CATERPILLAR 3306 DIESEL	1991-1992	FREIGHTLINER	COLUMBIA	DETROIT DIESEL 6 CIL, 14.0 L DIESEL	2002-2011
KENWORTH	T2000	CUMMINS ISX DIESEL	1999-2006	FREIGHTLINER	CORONADO	DETROIT DIESEL 6 CIL, 14.0 L DIESEL	2004-2010
KENWORTH	T2000	DETROIT DIESEL 6 CIL, 11.1 L DIESEL	2000-2000	FREIGHTLINER	FL112	CATERPILLAR C12 DIESEL	1999-2001
KENWORTH	T400	CATERPILLAR 3176 DIESEL	1991-1992	FREIGHTLINER	FL112	CUMMINS ISM DIESEL	1999-2003
KENWORTH	T400	CUMMINS L10 DIESEL	1991-1994	FREIGHTLINER	FLC	CATERPILLAR 3176 DIESEL	1991-1995
KENWORTH	T600	CATERPILLAR 3176 DIESEL	1993-1993	FREIGHTLINER	FLC	CATERPILLAR 3406 DIESEL	1991-1993
KENWORTH	T600	CUMMINS ISX DIESEL	2002-2010	FREIGHTLINER	FLD	CATERPILLAR C12 DIESEL	2001-2001
KENWORTH	T600	CUMMINS L10 DIESEL	1991-1994	FREIGHTLINER	FLD	CATERPILLAR C16 DIESEL	2000-2004
KENWORTH	T800	CATERPILLAR 3176 DIESEL	1991-1992	FREIGHTLINER	FLD	CUMMINS ISM DIESEL	2001-2001
KENWORTH	T800	CATERPILLAR C11 DIESEL	2003-2009	FREIGHTLINER	FLD	CUMMINS L10 DIESEL	1991-1993
KENWORTH	T800	CATERPILLAR C15 DIESEL	2004-2013	FREIGHTLINER	FLD	CUMMINS N14 DIESEL	1997-2001
KENWORTH	T800	CATERPILLAR C16 DIESEL	2000-2000	FREIGHTLINER	FLD	DETROIT DIESEL 6 CIL, 11.1 L DIESEL	1991-1996
KENWORTH	T800	CUMMINS ISL DIESEL	2001-2009	INTERNATIONAL/NAVISTAR	5000	CUMMINS N14 DIESEL	1995-1998
KENWORTH	T800	CUMMINS L10 DIESEL	1991-1994	INTERNATIONAL/NAVISTAR	5000	INTERNATIONAL/NAVISTAR 530 DIESEL	1995-1995
KENWORTH	T800	CUMMINS N14 DIESEL	1992-1996	INTERNATIONAL/NAVISTAR	5500i	CATERPILLAR C12 DIESEL	2003-2004
KENWORTH	W900	CATERPILLAR 3406 DIESEL	1991-1998	INTERNATIONAL/NAVISTAR	5500i	CATERPILLAR C13 DIESEL	2005-2007
KENWORTH	W900	CATERPILLAR C11 DIESEL	2005-2007	INTERNATIONAL/NAVISTAR	5500i	CUMMINS ISM DIESEL	2002-2006
KENWORTH	W900	CATERPILLAR C11 DIESEL	2005-2007	INTERNATIONAL/NAVISTAR	5500i	CUMMINS ISX DIESEL	2003-2007
MACK	CHN SERIES	MACK AC DIESEL	2006-2007	INTERNATIONAL/NAVISTAR	7400	INTERNATIONAL/NAVISTAR DT466	2005-2007
MACK	CV SERIES	MACK AI DIESEL	2006-2007	INTERNATIONAL/NAVISTAR	7400	INTERNATIONAL/NAVISTAR DT530 DIESEL	2004-2005
MACK	RD SERIES	MACK 6 CIL, 12.0 L DIESEL	2001-2001	INTERNATIONAL/NAVISTAR	7500	INTERNATIONAL/NAVISTAR HT570 DIESEL	2005-2007
STERLING	A-LINE	CATERPILLAR 3406 DIESEL	2000-2001	INTERNATIONAL/NAVISTAR	7600	CATERPILLAR C10 DIESEL	2002-2004
STERLING	A-LINE	CUMMINS ISM DIESEL	2000-2001	INTERNATIONAL/NAVISTAR	7600	CATERPILLAR C12 DIESEL	2004-2004
STERLING	A-LINE	CUMMINS ISM DIESEL	2000-2001	INTERNATIONAL/NAVISTAR	7700	CATERPILLAR C13 DIESEL	2005-2006
STERLING	A-LINE	DETROIT DIESEL 6 CIL, 12.7 L DIESEL	2000-2002	INTERNATIONAL/NAVISTAR	8600	CATERPILLAR C13 DIESEL	2004-2004
STERLING	L-LINE	CATERPILLAR 3406 DIESEL	2000-2001	INTERNATIONAL/NAVISTAR	8600	CUMMINS ISM DIESEL	2003-2007
STERLING	L-LINE	CUMMINS ISM DIESEL	2000-2003	INTERNATIONAL/NAVISTAR	9100i	CUMMINS ISM DIESEL	2000-2000
STERLING	L-LINE	CUMMINS SIGNATURE 600 DIESEL	2001-2001	INTERNATIONAL/NAVISTAR	9100i	DETROIT DIESEL SERIE 60	2000-2000
STERLING	L-LINE	DETROIT DIESEL 6 CIL, 14.0 L DIESEL	2004-2004	INTERNATIONAL/NAVISTAR	9200i	CATERPILLAR C10 DIESEL	2000-2003
STERLING	L-LINE	DETROIT DIESEL 6 CIL, 14.0 L DIESEL	2005-2008	INTERNATIONAL/NAVISTAR	9300	CUMMINS M11 DIESEL	1996-1997
STERLING	L-LINE	DETROIT DIESEL 6 CIL, 14.0 L DIESEL	2005-2008	INTERNATIONAL/NAVISTAR	9400	CATERPILLAR 3406 DIESEL	1995-1999
VOLVO	AUTOCAR	CUMMINS N14 DIESEL	1999-2001	INTERNATIONAL/NAVISTAR	9400	CATERPILLAR C12 DIESEL	1996-1999
VOLVO	AUTOCAR	DETROIT DIESEL 6 CIL, 12.7 L DIESEL	1999-2001	INTERNATIONAL/NAVISTAR	9400	DETROIT DIESEL SERIE 60	1997-1998
VOLVO	WCA SERIES	CUMMINS M11 DIESEL	1996-1997	INTERNATIONAL/NAVISTAR	9700	CUMMINS M11 DIESEL	1996-1996
VOLVO	WG SERIES	CATERPILLAR 3306 DIESEL	1996-1997	INTERNATIONAL/NAVISTAR	9900	CATERPILLAR 3406 DIESEL	1999-1999
VOLVO	WIA SERIES	CUMMINS N14 DIESEL	1996-1998	INTERNATIONAL/NAVISTAR	9900	CUMMINS N14 DIESEL	1999-1999
FREIGHTLINER	ARGOSY	CUMMINS ISM DIESEL	2000-2000	INTERNATIONAL/NAVISTAR	9900i	CATERPILLAR 3406 DIESEL	2000-2000
FREIGHTLINER	ARGOSY	DETROIT DIESEL 6 CIL, 12.7 L DIESEL	1999-2008	INTERNATIONAL/NAVISTAR	9900i	CATERPILLAR C15 DIESEL	2000-2000
FREIGHTLINER	CENTURY CLASS	CATERPILLAR C11 DIESEL	2006-2006	INTERNATIONAL/NAVISTAR	9900i	CUMMINS ISM DIESEL	2000-2000
FREIGHTLINER	CENTURY CLASS	CUMMINS N14 DIESEL	1998-2001	INTERNATIONAL/NAVISTAR	9900i	CUMMINS ISX DIESEL	2000-2008
FREIGHTLINER	CENTURY CLASS	DETROIT DIESEL 6 CIL, 14.0 L DIESEL	2004-2007	INTERNATIONAL/NAVISTAR	9900IX	CATERPILLAR C12 DIESEL	2000-2003
FREIGHTLINER	CENTURY CLASS	MERCEDES-BENZ MBE 4000 DIESEL	2004-2005	INTERNATIONAL/NAVISTAR	9900IX	CATERPILLAR C16 DIESEL	2002-2002
FREIGHTLINER	CENTURY CLASS	MERCEDES-BENZ MBE 4000 DIESEL	2001-2001	INTERNATIONAL/NAVISTAR	PROSTAR SERIES	CUMMINS ISX DIESEL	2007-2012
FREIGHTLINER	CLASSIC	CUMMINS ISM DIESEL	2001-2001	INTERNATIONAL/NAVISTAR	WORKSTAR 7600	CUMMINS ISM DIESEL	2008-2008
FREIGHTLINER	CLASSIC XL	CATERPILLAR C15 DIESEL	2005-2005	KENWORTH	K100	CUMMINS N14 DIESEL	1992-1993



MASTER SERVICIO PESADO 2014

MANGUERAS

MARCA	MODELO	MOTOR	AÑOS	MARCA	MODELO	MOTOR	AÑOS
KENWORTH	K100	DETROIT DIESEL 6 CIL. 11.1 L DIESEL	1996-1996	FREIGHTLINER	FLD	CATERPILLAR C13 DIESEL	2005-2007
KENWORTH	T2000	CATERPILLAR C15 DIESEL	2004-2010	FREIGHTLINER	FLD	CATERPILLAR C15 DIESEL	2000-2006
KENWORTH	T300	CUMMINS ISC DIESEL	2007-2008	FREIGHTLINER	FLD	CATERPILLAR C16 DIESEL	2000-2004
KENWORTH	T450	CUMMINS L10 DIESEL	1991-1994	FREIGHTLINER	FLD	CUMMINS M11 DIESEL	1995-1997
KENWORTH	T600	CATERPILLAR 3176 DIESEL	1991-1992	FREIGHTLINER	FLD	CUMMINS N14 DIESEL	1997-2001
KENWORTH	T600	CATERPILLAR 3406 DIESEL	1991-1999	FREIGHTLINER	FLD	DETROIT DIESEL 6 CIL. 11.1 L DIESEL	1991-2002
KENWORTH	T800	CATERPILLAR 3406 DIESEL	1993-2000	FREIGHTLINER	FLD	DETROIT DIESEL 6 CIL. 12.7 L DIESEL	1991-1996
KENWORTH	T800	CATERPILLAR C12 DIESEL	1996-1998	FREIGHTLINER	FLD	DETROIT DIESEL 6 CIL. 12.7 L DIESEL	1997-2008
KENWORTH	T800	CATERPILLAR C12 DIESEL	1999-2004	INTERNATIONAL/NAVISTAR	5000	CUMMINS N14 DIESEL	1995-1998
KENWORTH	T800	CATERPILLAR C13 DIESEL	2008-2014	INTERNATIONAL/NAVISTAR	5500I	CUMMINS ISX DIESEL	2006-2006
KENWORTH	T800	CUMMINS ISM DIESEL	2003-2003	INTERNATIONAL/NAVISTAR	5600I	CUMMINS ISM DIESEL	2002-2007
KENWORTH	T800	CUMMINS ISX DIESEL	1999-2014	INTERNATIONAL/NAVISTAR	5900I	CATERPILLAR C10 DIESEL	2000-2000
KENWORTH	W900	CATERPILLAR C15 DIESEL	2000-2010	INTERNATIONAL/NAVISTAR	5900I	CUMMINS ISM DIESEL	2001-2004
KENWORTH	W900	CATERPILLAR C16 DIESEL	2000-2003	INTERNATIONAL/NAVISTAR	5900I	CUMMINS N14 DIESEL	2002-2003
KENWORTH	W900	CUMMINS 6 CIL. 14.0 L DIESEL	1991-1991	INTERNATIONAL/NAVISTAR	7500	INTERNATIONAL/NAVISTAR DT530 DIESEL	2004-2005
KENWORTH	W900	CUMMINS N14 DIESEL	1993-1996	INTERNATIONAL/NAVISTAR	7600	CATERPILLAR C10 DIESEL	2002-2003
KENWORTH	W900	DETROIT DIESEL 6 CIL. 12.7 L DIESEL	1991-1999	INTERNATIONAL/NAVISTAR	7600	CATERPILLAR C11 DIESEL	2004-2007
KENWORTH	W900	DETROIT DIESEL 6 CIL. 12.7 L DIESEL	2000-2000	INTERNATIONAL/NAVISTAR	7600	CATERPILLAR C13 DIESEL	2004-2006
MACK	CL SERIES	CUMMINS ISX DIESEL	2004-2007	INTERNATIONAL/NAVISTAR	7600	CUMMINS ISM DIESEL	2003-2007
MACK	CV SERIES	MACK AMI DIESEL	2005-2005	INTERNATIONAL/NAVISTAR	8100	CATERPILLAR 3176 DIESEL	1996-1997
MACK	CXP SERIES	MACK MP7 DIESEL	2006-2006	INTERNATIONAL/NAVISTAR	8100	CUMMINS L10 DIESEL	1995-1996
STERLING	ACTERRA	CATERPILLAR 3126 DIESEL	2001-2004	INTERNATIONAL/NAVISTAR	8100	CUMMINS M11 DIESEL	1995-1997
STERLING	ACTERRA	CATERPILLAR C13 DIESEL	2004-2004	INTERNATIONAL/NAVISTAR	8100	INTERNATIONAL/NAVISTAR 530 DIESEL	1995-2003
STERLING	A-LINE	CATERPILLAR C10 DIESEL	2000-2004	INTERNATIONAL/NAVISTAR	8200	CUMMINS M11 DIESEL	1996-1997
STERLING	A-LINE	CATERPILLAR C12 DIESEL	2002-2004	INTERNATIONAL/NAVISTAR	8200	INTERNATIONAL/NAVISTAR DT466	1997-1997
STERLING	L-LINE	CATERPILLAR C13 DIESEL	2007-2007	INTERNATIONAL/NAVISTAR	8600	CATERPILLAR C12 DIESEL	2003-2004
VOLVO	VNL	CUMMINS ISX DIESEL	2000-2002	INTERNATIONAL/NAVISTAR	8600	CUMMINS ISM DIESEL	2003-2007
VOLVO	VNL	CUMMINS N14 DIESEL	1998-2003	INTERNATIONAL/NAVISTAR	9100I	CATERPILLAR C12 DIESEL	2000-2003
VOLVO	VNL	DETROIT DIESEL 6 CIL. 11.1 L DIESEL	1998-2001	INTERNATIONAL/NAVISTAR	9100I	CUMMINS ISM DIESEL	2000-2000
VOLVO	WCA SERIES	CUMMINS M11 DIESEL	1996-1997	INTERNATIONAL/NAVISTAR	9100I	DETROIT DIESEL SERIE 60	2000-2000
FREIGHTLINER	ARGOSY	CATERPILLAR 3406 DIESEL	1999-2000	INTERNATIONAL/NAVISTAR	9200	CATERPILLAR C10 DIESEL	1996-1999
FREIGHTLINER	ARGOSY	CUMMINS ISM DIESEL	1999-2000	INTERNATIONAL/NAVISTAR	9200I	CATERPILLAR C12 DIESEL	2004-2004
FREIGHTLINER	CENTURY CLASS	CATERPILLAR C13 DIESEL	2006-2006	INTERNATIONAL/NAVISTAR	9300	CUMMINS M11 DIESEL	1996-1997
FREIGHTLINER	CENTURY CLASS	CATERPILLAR C15 DIESEL	2005-2006	INTERNATIONAL/NAVISTAR	9300	CUMMINS N14 DIESEL	1997-1999
FREIGHTLINER	CENTURY CLASS	CUMMINS M11 DIESEL	1996-1997	INTERNATIONAL/NAVISTAR	9300	DETROIT DIESEL 6 CIL. 12.7 L DIESEL	1995-1997
FREIGHTLINER	CENTURY CLASS	CUMMINS N14 DIESEL	1998-2001	INTERNATIONAL/NAVISTAR	9400	CATERPILLAR 3406 DIESEL	1995-1999
FREIGHTLINER	CENTURY CLASS	DETROIT DIESEL 6 CIL. 11.1 L DIESEL	1998-2003	INTERNATIONAL/NAVISTAR	9400	DETROIT DIESEL SERIE 60	1997-1999
FREIGHTLINER	CLASSIC XL	CUMMINS ISM DIESEL	2001-2001	INTERNATIONAL/NAVISTAR	9400I	CATERPILLAR C10 DIESEL	2000-2002
FREIGHTLINER	CLASSIC XL	DETROIT DIESEL 6 CIL. 14.0 L DIESEL	2001-2008	INTERNATIONAL/NAVISTAR	9400I	CATERPILLAR C15 DIESEL	2005-2007
FREIGHTLINER	COLUMBIA	CATERPILLAR C10 DIESEL	2001-2003	INTERNATIONAL/NAVISTAR	9400I	CUMMINS ISM DIESEL	2007-2007
FREIGHTLINER	COLUMBIA	CATERPILLAR C13 DIESEL	2004-2009	INTERNATIONAL/NAVISTAR	9400I	CUMMINS N14 DIESEL	2000-2003
FREIGHTLINER	COLUMBIA	CATERPILLAR C15 DIESEL	2005-2005	INTERNATIONAL/NAVISTAR	9900I	CATERPILLAR 3406 DIESEL	2000-2000
FREIGHTLINER	COLUMBIA	DETROIT DIESEL 6 CIL. 11.1 L DIESEL	2000-2001	INTERNATIONAL/NAVISTAR	9900I	CATERPILLAR C12 DIESEL	2000-2003
FREIGHTLINER	COLUMBIA	DETROIT DIESEL 6 CIL. 14.0 L DIESEL	2002-2003	INTERNATIONAL/NAVISTAR	9900I	CUMMINS ISM DIESEL	2000-2000
FREIGHTLINER	CORONADO	DETROIT DIESEL 6 CIL. 14.0 L DIESEL	2004-2010	INTERNATIONAL/NAVISTAR	9900IX	CATERPILLAR C15 DIESEL	2002-2003
FREIGHTLINER	FLC	CUMMINS L10 DIESEL	1991-1993	INTERNATIONAL/NAVISTAR	9900IX	CATERPILLAR C16 DIESEL	2000-2000
FREIGHTLINER	FLD	CATERPILLAR C12 DIESEL	2001-2001	INTERNATIONAL/NAVISTAR	9900IX	CUMMINS N14 DIESEL	2000-2003



MASTER SERVICIO PESADO 2014

MANGUERAS

MARCA	MODELO	MOTOR	AÑOS	MARCA	MODELO	MOTOR	AÑOS
INTERNATIONAL/NAVISTAR	9900IX	DETROIT DIESEL 6 CIL. 12.7 L DIESEL	2001-2002	FREIGHTLINER	FLC	CATERPILLAR 3306 DIESEL	1993-1994
KENWORTH	C500	CATERPILLAR 3176 DIESEL	1992-1992	FREIGHTLINER	FLD	CATERPILLAR C10 DIESEL	2001-2001
KENWORTH	K100	DETROIT DIESEL 6 CIL. 12.7 L DIESEL	1994-1996	FREIGHTLINER	FLD	CATERPILLAR C13 DIESEL	2005-2007
KENWORTH	T2000	CATERPILLAR 3406 DIESEL	1997-2000	FREIGHTLINER	FLD	CATERPILLAR C15 DIESEL	2000-2004
KENWORTH	T2000	CATERPILLAR C10 DIESEL	1997-1997	FREIGHTLINER	FLD	CUMMINS ISM DIESEL	2001-2001
KENWORTH	T300	PACCAR PX-6 DIESEL	2007-2010	FREIGHTLINER	FLD	CUMMINS ISX DIESEL	1999-2001
KENWORTH	T450	CUMMINS M11 DIESEL	1995-1995	FREIGHTLINER	FLD	CUMMINS L10 DIESEL	1991-1993
KENWORTH	T600	CATERPILLAR 3406 DIESEL	1993-1999	FREIGHTLINER	FLD	CUMMINS M11 DIESEL	1995-1997
KENWORTH	T600	CATERPILLAR C10 DIESEL	1996-2004	FREIGHTLINER	FLD	DETROIT DIESEL 6 CIL., 11.1 L DIESEL	1997-2002
KENWORTH	T600	CATERPILLAR C10 DIESEL	2002-2004	FREIGHTLINER	FLD	DETROIT DIESEL 6 CIL., 14.0 L DIESEL	2008-2010
KENWORTH	T600	CATERPILLAR C12 DIESEL	1996-2001	FREIGHTLINER	FLD	DETROIT DIESEL 6 CIL., 14.0 L DIESEL	2008-2010
KENWORTH	T800	CATERPILLAR 3406 DIESEL	1991-1998	INTERNATIONAL/NAVISTAR	5000	CUMMINS M11 DIESEL	1996-1997
KENWORTH	T800	CATERPILLAR 3406 DIESEL	1999-2000	INTERNATIONAL/NAVISTAR	5600I	CUMMINS ISX DIESEL	2006-2007
KENWORTH	T800	CATERPILLAR C11 DIESEL	2003-2009	INTERNATIONAL/NAVISTAR	5600I	CUMMINS N14 DIESEL	2002-2003
KENWORTH	T800	CATERPILLAR C12 DIESEL	1996-2004	INTERNATIONAL/NAVISTAR	7400	INTERNATIONAL/NAVISTAR DT466	2002-2003
KENWORTH	T800	CATERPILLAR C15 DIESEL	2000-2000	INTERNATIONAL/NAVISTAR	7700	CATERPILLAR C13 DIESEL	2005-2005
KENWORTH	T800	CUMMINS ISM DIESEL	2003-2007	INTERNATIONAL/NAVISTAR	7700	CUMMINS ISM DIESEL	2005-2006
KENWORTH	W900	CATERPILLAR 3406 DIESEL	1999-2000	INTERNATIONAL/NAVISTAR	8100	CATERPILLAR C10 DIESEL	2002-2003
KENWORTH	W900	CATERPILLAR C16 DIESEL	2000-2003	INTERNATIONAL/NAVISTAR	8200	CUMMINS L10 DIESEL	1995-1997
KENWORTH	W900	CUMMINS ISX DIESEL	1999-2007	INTERNATIONAL/NAVISTAR	8200	CUMMINS M11 DIESEL	1995-1996
KENWORTH	W900	CUMMINS SIGNATURE 600 DIESEL	2000-2002	INTERNATIONAL/NAVISTAR	8200	DETROIT DIESEL 6 CIL., 11.1 L DIESEL	1995-1995
KENWORTH	W900	DETROIT DIESEL 6 CIL., 11.1 L DIESEL	1991-1999	INTERNATIONAL/NAVISTAR	8200	INTERNATIONAL/NAVISTAR 530 DIESEL	1996-1997
MACK	CTP SERIES	MACK MP7 DIESEL	2007-2007	INTERNATIONAL/NAVISTAR	8200	INTERNATIONAL/NAVISTAR DT466	1997-1997
STERLING	A-LINE	DETROIT DIESEL 6 CIL., 11.1 L DIESEL	2000-2002	INTERNATIONAL/NAVISTAR	8600	CATERPILLAR C11 DIESEL	2005-2007
STERLING	A-LINE	DETROIT DIESEL 6 CIL., 12.7 L DIESEL	2004-2004	INTERNATIONAL/NAVISTAR	8600	CATERPILLAR C13 DIESEL	2006-2006
STERLING	L-LINE	DETROIT DIESEL 6 CIL., 12.7 L DIESEL	2005-2008	INTERNATIONAL/NAVISTAR	9100	CATERPILLAR 3406 DIESEL	1998-1998
VOLVO	AUTOCAR	CUMMINS N14 DIESEL	1999-2001	INTERNATIONAL/NAVISTAR	9100	CATERPILLAR C10 DIESEL	1999-1999
VOLVO	AUTOCAR	DETROIT DIESEL 6 CIL., 11.1 L DIESEL	1999-2001	INTERNATIONAL/NAVISTAR	9100	CUMMINS N14 DIESEL	1998-1999
VOLVO	VNL	CUMMINS N14 DIESEL	1998-2003	INTERNATIONAL/NAVISTAR	9100	DETROIT DIESEL SERIE 60	1998-1999
VOLVO	WG SERIES	CUMMINS L10 DIESEL	1996-1997	INTERNATIONAL/NAVISTAR	9200	CATERPILLAR C12 DIESEL	1996-1999
VOLVO	WG SERIES	CUMMINS M11 DIESEL	1996-1997	INTERNATIONAL/NAVISTAR	9200	CUMMINS N14 DIESEL	1996-1999
FREIGHTLINER	BUSINESS CLASS M2	CATERPILLAR C7 DIESEL	2005-2005	INTERNATIONAL/NAVISTAR	9200	DETROIT DIESEL SERIE 60	1998-1999
FREIGHTLINER	CENTURY CLASS	CUMMINS M11 DIESEL	1996-1997	INTERNATIONAL/NAVISTAR	9300	CATERPILLAR C12 DIESEL	1996-1998
FREIGHTLINER	CENTURY CLASS	DETROIT DIESEL 6 CIL., 11.1 L DIESEL	1998-2003	INTERNATIONAL/NAVISTAR	9400	CUMMINS M11 DIESEL	1996-1997
FREIGHTLINER	CENTURY CLASS	DETROIT DIESEL 6 CIL., 12.7 L DIESEL	1998-2007	INTERNATIONAL/NAVISTAR	9400I	DETROIT DIESEL 6 CIL., 12.7 L DIESEL	2001-2003
FREIGHTLINER	CENTURY CLASS	DETROIT DIESEL SERIES 55 DIESEL	1997-1997	INTERNATIONAL/NAVISTAR	9800	CUMMINS M11 DIESEL	1997-1997
FREIGHTLINER	CENTURY CLASS	MERCEDES-BENZ MBE 4000 DIESEL	2001-2001	INTERNATIONAL/NAVISTAR	9800	DETROIT DIESEL SERIE 60	1997-1997
FREIGHTLINER	CLASSIC XL	CUMMINS ISM DIESEL	2001-2001	INTERNATIONAL/NAVISTAR	9900IX	CATERPILLAR 3406 DIESEL	2000-2000
FREIGHTLINER	CLASSIC XL	CUMMINS ISM DIESEL	2001-2001	INTERNATIONAL/NAVISTAR	9900IX	CUMMINS ISM DIESEL	2000-2000
FREIGHTLINER	CLASSIC XL	DETROIT DIESEL 6 CIL., 11.1 L DIESEL	2001-2002	INTERNATIONAL/NAVISTAR	CXT	INTERNATIONAL/NAVISTAR DT466	2005-2006
FREIGHTLINER	COLUMBIA	CATERPILLAR C12 DIESEL	2003-2003	KENWORTH	C500	CATERPILLAR C16 DIESEL	2000-2000
FREIGHTLINER	COLUMBIA	CUMMINS N14 DIESEL	2003-2003	KENWORTH	C500	DETROIT DIESEL 6 CIL., 12.7 L DIESEL	1991-1994
FREIGHTLINER	COLUMBIA	DETROIT DIESEL 6 CIL., 12.7 L DIESEL	2007-2009	KENWORTH	T2000	CATERPILLAR C12 DIESEL	1997-1997
FREIGHTLINER	COLUMBIA	DETROIT DIESEL 6 CIL., 12.7 L DIESEL	2000-2003	KENWORTH	T2000	CATERPILLAR C15 DIESEL	2002-2003
FREIGHTLINER	COLUMBIA	DETROIT DIESEL 6 CIL., 12.7 L DIESEL	2004-2009	KENWORTH	T400	CATERPILLAR 3176 DIESEL	1993-1993
FREIGHTLINER	FL112	CUMMINS ISM DIESEL	1998-2003	KENWORTH	T450	CUMMINS M11 DIESEL	1995-1995
FREIGHTLINER	FL112	CUMMINS M11 DIESEL	1996-1997	KENWORTH	T600	CATERPILLAR C10 DIESEL	1997-2001



MASTER SERVICIO PESADO 2014

MANGUERAS

MARCA	MODELO	MOTOR	AÑOS	MARCA	MODELO	MOTOR	AÑOS
KENWORTH	T600	CATERPILLAR C12 DIESEL	2002-2004	FREIGHTLINER	FLD	CATERPILLAR 3406 DIESEL	1995-2000
KENWORTH	T800	CATERPILLAR 3176 DIESEL	1993-1993	FREIGHTLINER	FLD	DETROIT DIESEL 6 CIL, 14.0 L DIESEL	2001-2001
KENWORTH	T800	CATERPILLAR C10 DIESEL	1996-2004	INTERNATIONAL/NAVISTAR	9100	CATERPILLAR 3406 DIESEL	1998-1998
KENWORTH	T800	CATERPILLAR C13 DIESEL	2004-2007	INTERNATIONAL/NAVISTAR	9200	CATERPILLAR 3406 DIESEL	1996-1998
KENWORTH	T800	CUMMINS ISM DIESEL	2004-2007	KENWORTH	T2000	CATERPILLAR C15 DIESEL	2003-2003
KENWORTH	T800	CUMMINS ISX DIESEL	2003-2003	KENWORTH	T400	CUMMINS L10 DIESEL	1991-1994
KENWORTH	T800	CUMMINS M11 DIESEL	1995-1996	KENWORTH	T600	CUMMINS ISX DIESEL	2002-2010
KENWORTH	W900	CATERPILLAR 3406 DIESEL	1999-2000	KENWORTH	T600	CUMMINS M11 DIESEL	1995-1996
KENWORTH	W900	CUMMINS ISM DIESEL	2003-2006	KENWORTH	T600	DETROIT DIESEL 6 CIL, 11.1 L DIESEL	1994-1999
KENWORTH	W900	CUMMINS N14 DIESEL	1992-2003	KENWORTH	T800	CATERPILLAR C11 DIESEL	2003-2009
KENWORTH	W900	DETROIT DIESEL 6 CIL, 12.7 L DIESEL	1994-2000	KENWORTH	T800	CATERPILLAR C15 DIESEL	2005-2013
MACK	CS SERIES	MACK AC DIESEL	2003-2003	KENWORTH	T800	CUMMINS ISX DIESEL	1999-2007
STERLING	A-LINE	CATERPILLAR C12 DIESEL	2000-2001	KENWORTH	T800	CUMMINS L10 DIESEL	1991-1994
STERLING	A-LINE	DETROIT DIESEL 6 CIL, 12.7 L DIESEL	2005-2005	KENWORTH	W900	CATERPILLAR 3406 DIESEL	1991-1998
STERLING	L-LINE	CATERPILLAR C10 DIESEL	2000-2004	KENWORTH	W900	CATERPILLAR 3406 DIESEL	1999-2000
STERLING	L-LINE	CATERPILLAR C12 DIESEL	2000-2004	VOLVO	AUTOCAR	DETROIT DIESEL 6 CIL, 12.7 L DIESEL	2000-2001
STERLING	L-LINE	CUMMINS ISM DIESEL	2000-2003	FREIGHTLINER	CENTURY CLASS	DETROIT DIESEL 6 CIL, 11.1 L DIESEL	1998-1998
STERLING	L-LINE	CUMMINS ISX DIESEL	2001-2001	FREIGHTLINER	CLASSIC XL	CATERPILLAR C15 DIESEL	2001-2004
STERLING	L-LINE	DETROIT DIESEL 6 CIL, 11.1 L DIESEL	2000-2002	FREIGHTLINER	CLASSIC XL	CATERPILLAR C16 DIESEL	2001-2001
STERLING	L-LINE	MERCEDES-BENZ MBE 4000 DIESEL	2003-2005	FREIGHTLINER	FLD	CATERPILLAR C16 DIESEL	2000-2004
VOLVO	AUTOCAR	DETROIT DIESEL 6 CIL, 11.1 L DIESEL	1999-2001	FREIGHTLINER	FLD	CUMMINS N14 DIESEL	1999-2001
VOLVO	WG SERIES	CUMMINS L10 DIESEL	1996-1997	FREIGHTLINER	FLD	DETROIT DIESEL 6 CIL, 12.7 L DIESEL	1997-2001
VOLVO	WG SERIES	CUMMINS M11 DIESEL	1996-1997	KENWORTH	C500	CATERPILLAR C16 DIESEL	2000-2000
VOLVO	WIA SERIES	CUMMINS L10 DIESEL	1997-1997	KENWORTH	C500	DETROIT DIESEL 6 CIL, 12.7 L DIESEL	1994-1994
VOLVO	WIA SERIES	DETROIT DIESEL 6 CIL, 11.1 L DIESEL	1996-1998	KENWORTH	T2000	CATERPILLAR C15 DIESEL	2002-2010
				KENWORTH	T2000	CATERPILLAR C16 DIESEL	2003-2003
FREIGHTLINER	ARGOSY	DETROIT DIESEL 6 CIL, 11.1 L DIESEL	1999-2003	KENWORTH	T600	CATERPILLAR 3406 DIESEL	1991-1992
FREIGHTLINER	ARGOSY	DETROIT DIESEL 6 CIL, 12.7 L DIESEL	1999-2008	KENWORTH	T800	CATERPILLAR 3406 DIESEL	1999-2000
FREIGHTLINER	ARGOSY	DETROIT DIESEL 6 CIL, 14.0 L DIESEL	2001-2008	KENWORTH	T800	CATERPILLAR C12 DIESEL	1996-2004
INTERNATIONAL/NAVISTAR	7500	INTERNATIONAL/NAVISTAR HT570 DIESEL	2005-2006	KENWORTH	T800	CATERPILLAR C16 DIESEL	2000-2000
INTERNATIONAL/NAVISTAR	7500	INTERNATIONAL/NAVISTAR HT570 DIESEL	2005-2006	KENWORTH	T800	CUMMINS ISM DIESEL	2004-2007
VOLVO	VNL	CUMMINS ISX DIESEL	2004-2013	KENWORTH	T800	CUMMINS N14 DIESEL	1993-2001
FREIGHTLINER	ARGOSY	DETROIT DIESEL 6 CIL, 11.1 L DIESEL	1999-2003	KENWORTH	T800	DETROIT DIESEL 6 CIL, 12.7 L DIESEL	1994-1999
INTERNATIONAL/NAVISTAR	7400	INTERNATIONAL/NAVISTAR 530 DIESEL	2002-2003	KENWORTH	W900	CATERPILLAR C15 DIESEL	2000-2007
FREIGHTLINER	ARGOSY	DETROIT DIESEL 6 CIL, 14.0 L DIESEL	2001-2008	KENWORTH	W900	CATERPILLAR C16 DIESEL	2000-2003
INTERNATIONAL/NAVISTAR	7500	INTERNATIONAL/NAVISTAR 530 DIESEL	2002-2003	KENWORTH	W900	DETROIT DIESEL 6 CIL, 12.7 L DIESEL	1994-1999
VOLVO	VNL	CUMMINS ISX DIESEL	2007-2007	MACK	CL SERIES	CUMMINS ISX DIESEL	2004-2007
VOLVO	VNM	CUMMINS ISX DIESEL	2006-2013	STERLING	A-LINE	CATERPILLAR 3406 DIESEL	2000-2001
FREIGHTLINER	ARGOSY	DETROIT DIESEL 6 CIL, 12.7 L DIESEL	1999-2008	FREIGHTLINER	CENTURY CLASS	DETROIT DIESEL 6 CIL, 12.7 L DIESEL	1998-1998
				FREIGHTLINER	CLASSIC XL	CATERPILLAR C16 DIESEL	2001-2003
				FREIGHTLINER	FLC	DETROIT DIESEL 6 CIL, 11.1 L DIESEL	1991-1998
MERCEDES BENZ	BOXER	MB 904	2005-2010	FREIGHTLINER	FLD	CATERPILLAR C15 DIESEL	2000-2004
				FREIGHTLINER	FLD	CATERPILLAR C16 DIESEL	2000-2001
				FREIGHTLINER	FLD	DETROIT DIESEL 6 CIL, 11.1 L DIESEL	1997-2001
FREIGHTLINER	CENTURY CLASS	CATERPILLAR 3406 DIESEL	1998-1999	FREIGHTLINER	FLD	DETROIT DIESEL 6 CIL, 12.7 L DIESEL	2001-2001
FREIGHTLINER	CLASSIC	CATERPILLAR C15 DIESEL	2001-2001	INTERNATIONAL/NAVISTAR	9400	CATERPILLAR 3406 DIESEL	1995-1998
FREIGHTLINER	CLASSIC	CATERPILLAR C16 DIESEL	2001-2001	INTERNATIONAL/NAVISTAR	9900IX	CATERPILLAR C15 DIESEL	2004-2007
FREIGHTLINER	CLASSIC	CUMMINS N14 DIESEL	2001-2001				
FREIGHTLINER	CLASSIC	DETROIT DIESEL 6 CIL, 12.7 L DIESEL	2001-2001				



MASTER SERVICIO PESADO 2014

MANGUERAS







MARCA	MODELO	MOTOR	AÑOS	MARCA	MODELO	MOTOR	AÑOS
KENWORTH	C500	CATERPILLAR C15 DIESEL	2000-2003	FREIGHTLINER	CENTURY CLASS	CATERPILLAR 3406 DIESEL	1996-1999
KENWORTH	K100	DETROIT DIESEL 6 CIL, 11.1 L DIESEL	1996-1996	FREIGHTLINER	CENTURY CLASS	CATERPILLAR C15 DIESEL	2001-2004
KENWORTH	T2000	CATERPILLAR C12 DIESEL	1997-1997	FREIGHTLINER	CLASSIC	DETROIT DIESEL 6 CIL, 11.1 L DIESEL	2001-2001
KENWORTH	T2000	CATERPILLAR C16 DIESEL	2002-2003	FREIGHTLINER	CLASSIC XL	DETROIT DIESEL 6 CIL, 14.0 L DIESEL	2001-2001
KENWORTH	T600	CATERPILLAR C10 DIESEL	1998-2001	FREIGHTLINER	FLD	DETROIT DIESEL 6 CIL, 11.1 L DIESEL	1991-1998
KENWORTH	T600	CATERPILLAR C12 DIESEL	1996-2001	KENWORTH	K100	CATERPILLAR 3406 DIESEL	1991-1994
KENWORTH	T800	CATERPILLAR 3406 DIESEL	1991-1992	KENWORTH	K100	DETROIT DIESEL 6 CIL, 12.7 L DIESEL	1994-1996
KENWORTH	T800	CATERPILLAR 3406 DIESEL	1993-2000	KENWORTH	T450	CATERPILLAR 3176 DIESEL	1993-1993
KENWORTH	T800	CATERPILLAR C12 DIESEL	2001-2002	KENWORTH	T600	CATERPILLAR 3176 DIESEL	1993-1993
KENWORTH	W900	CATERPILLAR C11 DIESEL	2005-2007	KENWORTH	W900	CATERPILLAR C10 DIESEL	1997-2000
KENWORTH	W900	CATERPILLAR C16 DIESEL	2000-2003	FREIGHTLINER	CLASSIC	CATERPILLAR C15 DIESEL	2001-2003
VOLVO	AUTOCAR	DETROIT DIESEL 6 CIL, 11.1 L DIESEL	1999-2001	FREIGHTLINER	CLASSIC	CATERPILLAR C16 DIESEL	2001-2003
VOLVO	VNL	CATERPILLAR 3406 DIESEL	1999-1999	FREIGHTLINER	CLASSIC	DETROIT DIESEL 6 CIL, 12.7 L DIESEL	2001-2001
FREIGHTLINER	CLASSIC XL	DETROIT DIESEL 6 CIL, 11.1 L DIESEL	2001-2001	FREIGHTLINER	FLC	DETROIT DIESEL 6 CIL, 12.7 L DIESEL	1991-1998
FREIGHTLINER	CLASSIC XL	DETROIT DIESEL 6 CIL, 12.7 L DIESEL	2001-2001	FREIGHTLINER	FLD	CATERPILLAR 3406 DIESEL	1995-2000
FREIGHTLINER	FLC	CUMMINS N14 DIESEL	1991-1998	FREIGHTLINER	FLD	CUMMINS N14 DIESEL	1991-1997
FREIGHTLINER	FLD	CATERPILLAR C15 DIESEL	2000-2001	FREIGHTLINER	FLD	DETROIT DIESEL 6 CIL, 14.0 L DIESEL	2001-2001
FREIGHTLINER	FLD	DETROIT DIESEL 6 CIL, 11.1 L DIESEL	2001-2001	INTERNATIONAL/NAVISTAR	9900I	CATERPILLAR C15 DIESEL	2004-2008
FREIGHTLINER	FLD	DETROIT DIESEL 6 CIL, 12.7 L DIESEL	1991-1998	KENWORTH	T2000	CATERPILLAR 3406 DIESEL	1997-1999
INTERNATIONAL/NAVISTAR	3800	INTERNATIONAL/NAVISTAR T444 DIESEL	2001-2001	KENWORTH	T2000	CATERPILLAR C10 DIESEL	1997-1997
INTERNATIONAL/NAVISTAR	5900I	CATERPILLAR C15 DIESEL	2004-2006	KENWORTH	T600	CATERPILLAR 3406 DIESEL	1993-1999
INTERNATIONAL/NAVISTAR	9400I	CATERPILLAR C15 DIESEL	2005-2007	KENWORTH	T600	CATERPILLAR C10 DIESEL	1996-2001
KENWORTH	K100	CUMMINS 6 CIL, 14.0 L DIESEL	1991-1991	KENWORTH	W900	CATERPILLAR 3406 DIESEL	1999-2000
KENWORTH	T600	CATERPILLAR C12 DIESEL	1996-2001	KENWORTH	W900	CUMMINS ISM DIESEL	2006-2006
KENWORTH	T600	CUMMINS L10 DIESEL	1991-1994	KENWORTH	W900	DETROIT DIESEL 6 CIL, 11.1 L DIESEL	1994-1999
KENWORTH	T800	CATERPILLAR C10 DIESEL	2000-2002	STERLING	L-LINE	CATERPILLAR 3406 DIESEL	2000-2001
KENWORTH	T800	CATERPILLAR C13 DIESEL	2004-2007	VOLVO	AUTOCAR	DETROIT DIESEL 6 CIL, 12.7 L DIESEL	1999-2001
KENWORTH	T800	CATERPILLAR C15 DIESEL	2000-2000	VOLVO	VNL	CATERPILLAR 3406 DIESEL	1997-1999
KENWORTH	T800	CUMMINS M11 DIESEL	1995-1996	VOLVO	WG SERIES	CUMMINS ISM DIESEL	1998-2000
KENWORTH	W900	CATERPILLAR C12 DIESEL	2000-2000	VOLVO	WIA SERIES	CATERPILLAR 3406 DIESEL	1996-1998
VOLVO	AUTOCAR	DETROIT DIESEL 6 CIL, 11.1 L DIESEL	2000-2001	FREIGHTLINER	CENTURY CLASS	CATERPILLAR C15 DIESEL	2001-2004
FREIGHTLINER	CLASSIC XL	CATERPILLAR C15 DIESEL	2001-2001	FREIGHTLINER	CLASSIC	DETROIT DIESEL 6 CIL, 11.1 L DIESEL	2001-2001
FREIGHTLINER	CLASSIC XL	CUMMINS N14 DIESEL	2001-2001	FREIGHTLINER	CLASSIC XL	DETROIT DIESEL 6 CIL, 14.0 L DIESEL	2001-2001
FREIGHTLINER	CLASSIC XL	DETROIT DIESEL 6 CIL, 11.1 L DIESEL	2001-2001	INTERNATIONAL/NAVISTAR	9300	CATERPILLAR 3406 DIESEL	1995-1998
FREIGHTLINER	CLASSIC XL	DETROIT DIESEL 6 CIL, 12.7 L DIESEL	2001-2001	KENWORTH	C500	CATERPILLAR 3176 DIESEL	1993-1993
INTERNATIONAL/NAVISTAR	PAYSTAR 5600i	CATERPILLAR C15 DIESEL	2008-2008	KENWORTH	C500	DETROIT DIESEL 6 CIL, 11.1 L DIESEL	1994-1994
KENWORTH	T450	CUMMINS M11 DIESEL	1995-1995	KENWORTH	K100	CUMMINS N14 DIESEL	1992-1993
KENWORTH	T600	CATERPILLAR C12 DIESEL	2002-2004	KENWORTH	T400	CATERPILLAR 3176 DIESEL	1993-1993
KENWORTH	T800	CATERPILLAR C10 DIESEL	1996-2004	KENWORTH	T450	CUMMINS L10 DIESEL	1991-1994
KENWORTH	T800	CATERPILLAR C13 DIESEL	2004-2007	KENWORTH	T600	CATERPILLAR C10 DIESEL	2002-2004
KENWORTH	T800	CATERPILLAR C15 DIESEL	2000-2013	KENWORTH	T600	CUMMINS N14 DIESEL	1993-2001
KENWORTH	T800	CATERPILLAR C16 DIESEL	2000-2000	KENWORTH	T600	CUMMINS SIGNATURE 600 DIESEL	2003-2003
KENWORTH	W900	CATERPILLAR C12 DIESEL	2000-2000	KENWORTH	T600	DETROIT DIESEL 6 CIL, 12.7 L DIESEL	1994-1999
KENWORTH	W900	CATERPILLAR C15 DIESEL	2000-2007	KENWORTH	T800	CATERPILLAR 3176 DIESEL	1993-1993
KENWORTH	W900	CUMMINS 6 CIL, 14.0 L DIESEL	1991-1991	KENWORTH	T800	DETROIT DIESEL 6 CIL, 11.1 L DIESEL	1994-1999
KENWORTH	W900	CUMMINS ISM DIESEL	2003-2005	KENWORTH	W900	CATERPILLAR C10 DIESEL	1997-2000
KENWORTH	W900	CUMMINS N14 DIESEL	1992-1993	KENWORTH	W900	CATERPILLAR C13 DIESEL	2004-2010

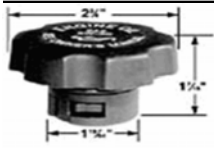
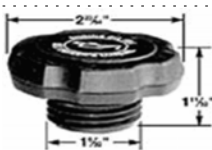

MASTER SERVICIO PESADO 2014

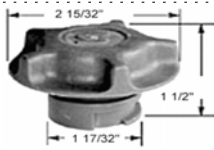
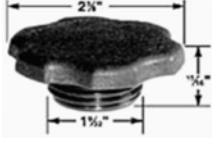
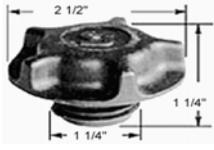





MANGUERAS

MARCA	MODELO	MOTOR	AÑOS	MARCA	MODELO	MOTOR	AÑOS
VOLVO	WG SERIES	CUMMINS M11 DIESEL	1997-1997				
VOLVO	WIA SERIES	CATERPILLAR 3406 DIESEL	1996-1998				
SIH400096A							
VOLVO	7550 FL	B12	2005-2008				
VOLVO	9700 FL	B12	2005-2011				
VOLVO	9700	B12	2002-2006				
VOLVO	7550	7550	2001-2006				
SIH400125C90							
MERCEDES BENZ	BOXER	MB 904	2005-2010				
SIH890305MM7A							
MERCEDES BENZ	TORINO	MB 906	2005-2010				

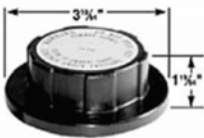
MARCA	MODELO	MOTOR	AÑOS	MARCA	MODELO	MOTOR	AÑOS				
 <p>31099 TAPÓN DE ACEITE</p>				FORD	F-750 SUPER DUTY	FORD V8, 7.3 L DIESEL	2000-2004				
				FORD	RANGER	4 CIL, 2.3 L	1997-2003				
				FORD	RANGER	4 CIL, 2.5 L	1999-2001				
				FORD	RANGER	V6, 3.0 L	1996-2000				
				FORD	RANGER	V6, 4.0 L	1999-2000				
				CHEVROLET	C5500	GM V8 7.4 L	1999-2000				
				CHEVROLET	C5500	GM V8 8.1 L	2001-2002				
				CHEVROLET	C6500	GM V8 7.4 L	1999-2000	 <p>31111 TAPÓN DE ACEITE</p>			
CHEVROLET	C6500	GM V8 8.1 L	2001-2002								
CHEVROLET	C7500	GM V8 7.4 L	1999-2000								
CHEVROLET	C7500	GM V8 8.1 L	2001-2002								
CHEVROLET	KODIAK	GM V8, 7.4 L	1995-2000								
CHEVROLET	KODIAK	GM V8, 8.1 L	2001-2008								
CHEVROLET	C5500	GM V8 6.0 L	1997-1998								
CHEVROLET	C5500	GM V8 7.0 L	1997-1998								
CHEVROLET	C6500	GM V8 6.0 L	1997-1998	 <p>31115 TAPÓN DE ACEITE</p>							
CHEVROLET	C6500	GM V8 7.0 L	1997-1998								
CHEVROLET	C7500	GM V8 6.0 L	1997-1998								
CHEVROLET	C7500	GM V8 7.0 L	1997-1998								
CHEVROLET	S-10	4 CIL, 2.2 L	1999-2002								
CHEVROLET	S-10	V6, 4.3 L	1992-2002								
CHEVROLET	S-10	4 CIL, 2.4 L	1993-1995								
CHEVROLET	S-10	4 CIL, 2.4 L	1993-1995								
 <p>31103 TAPÓN DE ACEITE</p>				 <p>31117 TAPÓN DE ACEITE</p>							
								CHEVROLET	S-10	4 CIL, 2.2 L	1999-2002
								CHEVROLET	S-10	V6, 4.3 L	1992-2002
								CHEVROLET	S-10	4 CIL, 2.4 L	1993-1995
								CHEVROLET	S-10	4 CIL, 2.4 L	1993-1995
								CHEVROLET	S-10	4 CIL, 2.2 L	1999-2002
								CHEVROLET	S-10	V6, 4.3 L	1992-2002
								CHEVROLET	S-10	4 CIL, 2.4 L	1993-1995
 <p>31109 TAPÓN DE ACEITE</p>				 <p>31118 TAPÓN DE ACEITE</p>							
								FORD	E450 SUPER DUTY	FORD V8, 5.4 L	2000-2005
								FORD	E450 SUPER DUTY	FORD V8, 7.3 L DIESEL	1998-1998
								FORD	F-350 SUPER DUTY	V8, 5.4 L	2004-2006
								FORD	F-450 SUPER DUTY	FORD V10, 6.8 L	1999-2004
								FORD	F-450 SUPER DUTY	V10, 6.8 L	1999-2013
								FORD	F-450 SUPER DUTY	V10, 6.8 L	2008-2010
								FORD	F-450 SUPER DUTY	V8, 7.3 L	2001-2003
FORD	F-450 SUPER DUTY	V8, 7.5 L	1997-1997	 <p>31124 TAPÓN DE ACEITE</p>							
FORD	F-450 SUPER DUTY	V8, 7.5 L	1997-1997								
FORD	F-550 SUPER DUTY	FORD V10, 6.8 L	1999-2004								
FORD	F-550 SUPER DUTY	V10, 6.8 L	2008-2010								
FORD	F-600	FORD V8, 7.0 L	1994-1994								
FORD	F-650 SUPER DUTY	FORD V8, 7.3 L DIESEL	2000-2004								
FORD	F-650 SUPER DUTY	FORD V8, 7.3 L DIESEL	2000-2004								
FORD	F-650 SUPER DUTY	FORD V8, 7.3 L DIESEL	2000-2004								
 <p>31127 TAPÓN DE ACEITE</p>				CHEVROLET	S-10	4 CIL, 2.2 L	1996-1998				
				CHEVROLET	S-10	4 CIL, 2.2 L	1996-1998				
				CHEVROLET	S-10	4 CIL, 2.2 L	1996-1998				
				CHEVROLET	S-10	4 CIL, 2.2 L	1996-1998				
				CHEVROLET	S-10	4 CIL, 2.2 L	1996-1998				
				CHEVROLET	S-10	4 CIL, 2.2 L	1996-1998				
				CHEVROLET	S-10	4 CIL, 2.2 L	1996-1998				
				CHEVROLET	S-10	4 CIL, 2.2 L	1996-1998				

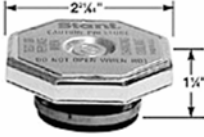

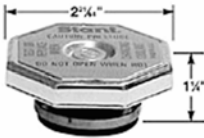



MARCA	MODELO	MOTOR	AÑOS	MARCA	MODELO	MOTOR	AÑOS
CHEVROLET	S-10	4 CIL, 2.2 L	1995-1995	VOLVO	VNM	VOLVO D16 DIESEL	2008-2013
 <p>31275 TAPÓN DE ACEITE</p>				VOLVO	VNM	VOLVO VE D12 DIESEL	2006-2008
				VOLVO	VNM	VOLVO VE D16 DIESEL	2006-2009
FORD	F-350 SUPER DUTY	V8, 6.2 L	2011-2013	 <p>31336 TAPÓN DE RADIADOR</p>			
FORD	F-450 SUPER DUTY	V10, 6.8 L	2009-2013				
FORD	F-450 SUPER DUTY	V10, 6.8 L	2008-2010	FORD	F-350 SUPER DUTY	V8, 5.4 L	2007-2009
FORD	F-450 SUPER DUTY	V8, 6.7 L DIESEL	2011-2013	FORD	F-450 SUPER DUTY	V10, 6.8 L	2007-2013
FORD	F-550 SUPER DUTY	V10, 6.8 L	2008-2010	FORD	F-550 SUPER DUTY	V10, 6.8 L	2008-2010
FORD	F-550 SUPER DUTY	V8, 6.7 L DIESEL	2011-2013	FORD	RANGER	4 CIL, 2.3 L	1997-2001
FORD	RANGER	4 CIL, 2.3 L	2001-2012	FORD	RANGER	4 CIL, 2.5 L	1999-2001
FORD	RANGER	V6, 3.0 L	2001-2002	FORD	RANGER	V6, 3.0 L	1996-2002
FORD	RANGER	V6, 4.0 L	2001-2001	FORD	RANGER	V6, 4.0 L	1999-2001
 <p>31333 TAPÓN DE RADIADOR</p>				 <p>31348 TAPÓN DE RADIADOR</p>			
GIANT MOTORS	GF-900	4 CIL, 1.0 L	2007-2008	 <p>31350 TAPÓN DE RADIADOR</p>			
ISUZU	ELF 200	4JJ1-TC	2009-2014				
ISUZU	ELF 300	4JJ1-TC	2007-2014	KENWORTH	C500	CATERPILLAR C13 DIESEL	2008-2008
NISSAN	CABSTAR	NISSAN DIESEL YD25DDTi	2008-2013	KENWORTH	C500	CATERPILLAR C15 DIESEL	2007-2008
NISSAN	ESTAQUITAS	4 CIL, 1.8 L	1993-1994	KENWORTH	T2000	CATERPILLAR C13 DIESEL	2004-2010
NISSAN	ESTAQUITAS	4 CIL, 2.4 L	1995-1996	KENWORTH	T2000	CATERPILLAR C15 DIESEL	2004-2010
NISSAN	NP300	4 CIL, 2.4 L	2008-2012	KENWORTH	T300	CUMMINS ISC DIESEL	2005-2008
NISSAN	NP300	4 CIL, 2.5 L DIESEL	2008-2012	KENWORTH	T300	PACCAR PX-6 DIESEL	2007-2010
NISSAN	PICK-UP	4 CIL, 2.4 L	1994-1996	KENWORTH	T370	PACCAR PX-6	2009-2013
NISSAN	URVAN	4 CIL, 3.0 L DIESEL	2009-2013	KENWORTH	T800	CATERPILLAR C11 DIESEL	2003-2009
NISSAN	URVAN	4 CIL, 2.5 L	2009-2013	KENWORTH	T800	CATERPILLAR C13 DIESEL	2008-2014
 <p>31335 TAPÓN DE RADIADOR</p>				KENWORTH	T800	CATERPILLAR C15 DIESEL	2008-2013
				KENWORTH	T800	CUMMINS ISL DIESEL	2001-2009
VOLVO	VNL	VOLVO D13 DIESEL	2008-2014	KENWORTH	T800	CUMMINS ISM DIESEL	1999-2014
VOLVO	VNL	VOLVO D16 DIESEL	2008-2013	KENWORTH	T800	CUMMINS ISX DIESEL	2002-2014
VOLVO	VNL	VOLVO VE D12 DIESEL	1998-2008	KENWORTH	W900	CATERPILLAR C13 DIESEL	2004-2010
VOLVO	VNL	VOLVO VE D16 DIESEL	2006-2009	KENWORTH	W900	CATERPILLAR C15 DIESEL	2008-2010
VOLVO	VNM	VOLVO D13 DIESEL	2008-2014	KENWORTH	W900	CUMMINS ISX DIESEL	2010-2013



MARCA	MODELO	MOTOR	AÑOS	MARCA	MODELO	MOTOR	AÑOS				
 <p>31406 TAPÓN DE RADIADOR</p>				CHEVROLET	C5500	CATERPILLAR 3116 DIESEL	1999-1999				
				CHEVROLET	C5500	CATERPILLAR 3126 DIESEL	1998-2002				
				CHEVROLET	C5500	GM V8 6.0 L	1997-1998				
				CHEVROLET	C5500	GM V8 7.0 L	1997-1998				
				CHEVROLET	C5500	GM V8 7.4 L	2000-2000				
				CHEVROLET	C5500	GM V8 8.1 L	2001-2002				
				CHEVROLET	C6500	CATERPILLAR 3116 DIESEL	1997-2000				
				CHEVROLET	C6500	CATERPILLAR 3126 DIESEL	1998-2003				
				CHEVROLET	C6500	GM V8 6.0 L	1997-1998				
				CHEVROLET	C6500	GM V8 7.0 L	1997-1998				
				CHEVROLET	C6500	GM V8 7.4 L	1999-2000				
				CHEVROLET	C6500	GM V8 8.1 L	2001-2002				
				CHEVROLET	C7500	CATERPILLAR 3116 DIESEL	1997-2000				
				CHEVROLET	C7500	CATERPILLAR 3126 DIESEL	1998-2003				
				CHEVROLET	C7500	GM V8 6.0 L	1997-1998				
				CHEVROLET	C7500	GM V8 7.0 L	1997-1998				
				CHEVROLET	C7500	GM V8 7.4 L	2000-2000				
CHEVROLET	C7500	GM V8 8.1 L	2001-2002								
CHEVROLET	KODIAK	CATERPILLAR 3116 DIESEL	1997-2000								
CHEVROLET	KODIAK	CATERPILLAR 3126 DIESEL	2000-2008								
CHEVROLET	KODIAK	GM V8, 7.4 L	1995-2000								
CHEVROLET	KODIAK	GM V8, 8.1 L	2001-2008								
MERCEDES BENZ	TORINO	MB 906	2005-2010								
 <p>31508 TAPÓN DE RADIADOR</p>				 <p>31523 TAPÓN DE RADIADOR</p>							
								FORD	F-600	CUMMINS B Series 5.9 L DIESEL	1992-1993
								FORD	F-600	CUMMINS C Series 8.3 L DIESEL	1993-1993
								FORD	F-600	FORD 6 CIL, 6.6 L DIESEL	1991-1993
								FORD	F-600	FORD 6 CIL, 7.8 L DIESEL	1991-1993
								FORD	F-600	FORD V8, 6.1 L	1991-1991
								FORD	F-600	FORD V8, 7.0 L	1991-1994
 <p>31511 TAPÓN DE RADIADOR</p>				 <p>31526 TAPÓN DE RADIADOR</p>							
								NISSAN	PICK-UP	4 CIL, 2.4 L	1993-1993
								FORD	F-600	CUMMINS B Series 5.9 L DIESEL	1992-1993
								FORD	F-600	CUMMINS C Series 8.3 L DIESEL	1993-1993
								FORD	F-600	FORD 6 CIL, 6.6 L DIESEL	1991-1993
 <p>31521 TAPÓN DE RADIADOR</p>				FORD	F-600	FORD 6 CIL, 7.8 L DIESEL	1991-1993				
				FORD	F-600	FORD V8, 6.1 L	1991-1991				
				FORD	F-600	FORD V8, 7.0 L	1991-1994				

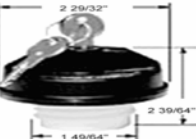

MARCA	MODELO	MOTOR	AÑOS	MARCA	MODELO	MOTOR	AÑOS
		31527 TAPÓN DE RADIADOR		CHEVROLET	C7500	GM V8 7.4 L	2000-2000
FORD	F-450 SUPER DUTY	V8, 7.5 L	1997-1997	CHEVROLET	C7500	GM V8 8.1 L	2001-2002
		31528 TAPÓN DE RADIADOR				31567 TAPÓN DE RADIADOR	
CHEVROLET	S-10	4 CIL, 2.2 L	1996-2003	INTERNATIONAL/NAVISTAR	4300	INTERNATIONAL/NAVISTAR DT466	2002-2008
CHEVROLET	S-10	V6, 4.3 L	1996-2002	INTERNATIONAL/NAVISTAR	4400	INTERNATIONAL/NAVISTAR DT466	2004-2008
DODGE	RAM-4000	V6, 5.9 L DIESEL	2008-2008	INTERNATIONAL/NAVISTAR	7600	CATERPILLAR C13 DIESEL	2004-2008
DODGE	RAM-4000	V6, 6.7 L DIESEL	2008-2013	INTERNATIONAL/NAVISTAR	9200I	CATERPILLAR C13 DIESEL	2004-2008
		31533 TAPÓN DE RADIADOR		INTERNATIONAL/NAVISTAR	9400I	CATERPILLAR C15 DIESEL	2007-2007
NISSAN	ESTAQUITAS	4 CIL, 1.8 L	1993-1994	INTERNATIONAL/NAVISTAR	CF500	INTERNATIONAL/NAVISTAR VT275 DIESEL	2005-2008
NISSAN	ESTAQUITAS	4 CIL, 2.4 L	1995-1996	INTERNATIONAL/NAVISTAR	CF600	INTERNATIONAL/NAVISTAR VT275 DIESEL	2005-2008
NISSAN	PICK-UP	4 CIL, 2.4 L	1994-1996	INTERNATIONAL/NAVISTAR	DURASTAR 4300	INTERNATIONAL/NAVISTAR MAXXFORCE 7 DIESEL	2009-2012
		31537 TAPÓN DE RADIADOR		INTERNATIONAL/NAVISTAR	DURASTAR 4300	INTERNATIONAL/NAVISTAR MAXXFORCE DT DIESEL	2008-2013
CHEVROLET	C5500	CATERPILLAR 3116 DIESEL	1999-1999	INTERNATIONAL/NAVISTAR	DURASTAR 4400	INTERNATIONAL/NAVISTAR MAXXFORCE DT DIESEL	2008-2013
CHEVROLET	C5500	CATERPILLAR 3126 DIESEL	1998-2002	INTERNATIONAL/NAVISTAR	PROSTAR SERIES	CUMMINS ISX DIESEL	2007-2012
CHEVROLET	C5500	GM V8 6.0 L	1997-1998	INTERNATIONAL/NAVISTAR	PROSTAR SERIES	INTERNATIONAL/NAVISTAR MAXXFORCE 13 DIESEL	2008-2010
CHEVROLET	C5500	GM V8 7.0 L	1997-1998	INTERNATIONAL/NAVISTAR	WORKSTAR 7300	INTERNATIONAL/NAVISTAR MAXXFORCE DT DIESEL	2008-2009
CHEVROLET	C5500	GM V8 7.4 L	2000-2000	INTERNATIONAL/NAVISTAR	WORKSTAR 7400	INTERNATIONAL/NAVISTAR MAXXFORCE 9 DIESEL	2008-2012
CHEVROLET	C5500	GM V8 8.1 L	2001-2002	INTERNATIONAL/NAVISTAR	WORKSTAR 7600	CUMMINS ISM DIESEL	2008-2010
CHEVROLET	C6500	CATERPILLAR 3116 DIESEL	1997-2000			31615 TAPÓN DE GASOLINA	
CHEVROLET	C6500	CATERPILLAR 3126 DIESEL	1998-2003	DODGE	RAM-4000	V6, 5.9 L DIESEL	1996-1996
CHEVROLET	C6500	GM V8 6.0 L	1997-1998	FORD	E450 SUPER DUTY	FORD V8, 7.3 L DIESEL	1998-1998
CHEVROLET	C6500	GM V8 7.0 L	1997-1998	FORD	F-350 SUPER DUTY	V8, 5.4 L	2004-2006
CHEVROLET	C6500	GM V8 7.4 L	1999-2000	FORD	F-450 SUPER DUTY	FORD V10, 6.8 L	2004-2004
CHEVROLET	C6500	GM V8 8.1 L	2001-2002	FORD	F-450 SUPER DUTY	V10, 6.8 L	1999-2006
CHEVROLET	C7500	CATERPILLAR 3116 DIESEL	1997-2000	FORD	F-450 SUPER DUTY	V8, 7.3 L	2001-2003
CHEVROLET	C7500	CATERPILLAR 3126 DIESEL	1998-2003	FORD	F-450 SUPER DUTY	V8, 7.5 L	1997-1997
CHEVROLET	C7500	GM V8 6.0 L	1997-1998	FORD	F-550 SUPER DUTY	FORD V10, 6.8 L	2004-2004
CHEVROLET	C7500	GM V8 7.0 L	1997-1998	FORD	RANGER	4 CIL, 2.3 L	1997-1997
		31636 TAPÓN DE GASOLINA		CHEVROLET	S-10	4 CIL, 2.2 L	1996-2001

MARCA	MODELO	MOTOR	AÑOS
CHEVROLET	S-10	V6, 4.3 L	1996-2002
 31734 TAPÓN DE GASOLINA			
FORD	E450 SUPER DUTY	FORD V8, 7.3 L DIESEL	1998-1998
FORD	F-450 SUPER DUTY	FORD V10, 6.8 L	2004-2004
FORD	F-550 SUPER DUTY	FORD V10, 6.8 L	2004-2004
FORD	RANGER	4 CIL, 2.3 L	1995-1996
FORD	RANGER	V6, 3.0 L	1995-1996
 31748 TAPÓN DE GASOLINA			
CHEVROLET	S-10	4 CIL, 2.2 L	1995-1995
CHEVROLET	S-10	V6, 4.3 L	1995-1995
 31778 TAPÓN DE GASOLINA			
CHEVROLET	S-10	4 CIL, 2.2 L	1994-1994
CHEVROLET	S-10	V6, 3.1 L	1991-1994
CHEVROLET	S-10	V6, 4.3 L	1991-1994
 31780 TAPÓN DE GASOLINA			
NISSAN	NV2500	V6, 4.0 L	2013-2014
NISSAN	NV2500	V8, 5.6 L	2013-2014
 31781 TAPÓN DE GASOLINA			
VOLKSWAGEN	EUROVAN	5 CIL, 2.5 L	2001-2003
 31782 TAPÓN DE GASOLINA			
CHEVROLET	S-10	4 CIL, 2.2 L	2002-2003

MARCA	MODELO	MOTOR	AÑOS
 31828 TAPÓN DE GASOLINA			
FORD	E450 SUPER DUTY	FORD V8, 5.4 L	2000-2003
FORD	E450 SUPER DUTY	FORD V8, 7.3 L DIESEL	1998-1998
FORD	F-450 SUPER DUTY	FORD V10, 6.8 L	1999-2004
FORD	F-550 SUPER DUTY	FORD V10, 6.8 L	1999-2004
FORD	RANGER	4 CIL, 2.3 L	1999-2003
FORD	RANGER	4 CIL, 2.5 L	1999-2003
FORD	RANGER	V6, 3.0 L	1999-2003
FORD	RANGER	V6, 4.0 L	1999-2003
 31830 TAPÓN DE GASOLINA			
FORD	E450 SUPER DUTY	FORD V8, 5.4 L	2000-2003
FORD	E450 SUPER DUTY	FORD V8, 7.3 L DIESEL	1998-1998
FORD	F-450 SUPER DUTY	FORD V10, 6.8 L	1999-2004
FORD	F-550 SUPER DUTY	FORD V10, 6.8 L	1999-2004
FORD	RANGER	4 CIL, 2.3 L	1999-2003
FORD	RANGER	4 CIL, 2.5 L	1999-2003
FORD	RANGER	V6, 3.0 L	1999-2003
FORD	RANGER	V6, 4.0 L	1999-2003
 31831 TAPÓN DE GASOLINA			
FORD	E450 SUPER DUTY	FORD V8, 5.4 L	2001-2001
 31832 TAPÓN DE GASOLINA			
NISSAN	NV2500	V6, 4.0 L	2013-2014
NISSAN	NV2500	V8, 5.6 L	2013-2014
 31833 TAPÓN DE GASOLINA			
VOLKSWAGEN	EUROVAN	5 CIL, 2.5 L	2001-2003



MASTER SERVICIO PESADO 2014

TAPONES

MARCA	MODELO	MOTOR	AÑOS	MARCA	MODELO	MOTOR	AÑOS
		31834 TAPÓN DE GASOLINA		FORD	F-550 SUPER DUTY	V8, 6.7 L DIESEL	2011-2013
FORD	E450 SUPER DUTY	FORD V8, 5.4 L	2001-2001	FORD	RANGER	4 CIL, 2.3 L	2004-2012
		31836 TAPÓN DE GASOLINA		FORD	RANGER	V6, 4.2 L	2004-2004
DODGE	RAM-4000	V6, 5.9 L DIESEL	2008-2008			31843 TAPÓN DE GASOLINA	
DODGE	RAM-4000	V6, 6.7 L DIESEL	2008-2011	ISUZU	ELF 200	4JJ1-TC	2009-2014
		31838 TAPÓN DE GASOLINA		ISUZU	ELF 300	4JJ1-TC	2007-2014
DODGE	RAM-4000	V6, 5.9 L DIESEL	2003-2008			31844 TAPÓN DE GASOLINA	
DODGE	RAM-4000	V6, 6.7 L DIESEL	2008-2011	ISUZU	ELF 200	4JJ1-TC	2009-2014
		31841 TAPÓN DE GASOLINA		ISUZU	ELF 300	4JJ1-TC	2007-2014
FORD	E450 SUPER DUTY	FORD V8, 5.4 L	2005-2005			RC216 TAPÓN DE RADIADOR	
FORD	F-350 SUPER DUTY	V8, 5.4 L	2007-2009	FIAT	DUCATO	4 CIL, 2.3 L DIESEL	2008-2013
FORD	F-350 SUPER DUTY	V8, 6.2 L	2011-2013	FIAT	DUCATO	4 CIL, 3.0 L DIESEL	2008-2013
FORD	F-450 SUPER DUTY	V10, 6.8 L	2007-2013	PEUGEOT	MANAGER	4 CIL, 2.2 L DIESEL	2013-2014
FORD	F-450 SUPER DUTY	V8, 6.7 L DIESEL	2011-2012	PEUGEOT	MANAGER	4 CIL, 3.0 L DIESEL	2008-2013
FORD	F-450 SUPER DUTY	V8, 6.7 L DIESEL	2011-2013			RC218 TAPÓN DE RADIADOR	
FORD	F-550 SUPER DUTY	V10, 6.8 L	2008-2010	PEUGEOT	EXPERT	4 CIL, 2.0 L HDI	2008-2010
FORD	F-550 SUPER DUTY	V8, 6.7 L DIESEL	2011-2013	PEUGEOT	PARTNER MAXI	4 CIL, 1.6 L TURBO DIESEL	2012-2014
FORD	RANGER	4 CIL, 2.3 L	2004-2012			RC240 TAPÓN DE RADIADOR	
FORD	RANGER	V6, 4.2 L	2004-2004	FORD	TRANSIT	4 CIL, 2.2 L TDI	2008-2013
		31842 TAPÓN DE GASOLINA					
FORD	E450 SUPER DUTY	FORD V8, 5.4 L	2005-2005				
FORD	F-350 SUPER DUTY	V8, 5.4 L	2007-2009				
FORD	F-350 SUPER DUTY	V8, 6.2 L	2011-2013				
FORD	F-450 SUPER DUTY	V10, 6.8 L	2007-2013				
FORD	F-450 SUPER DUTY	V8, 6.7 L DIESEL	2011-2013				
FORD	F-550 SUPER DUTY	V10, 6.8 L	2008-2010				

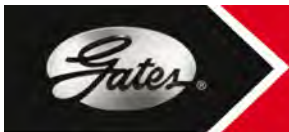

MASTER SERVICIO PESADO 2014

TENSORES Y POLEAS

MARCA	MODELO	MOTOR	AÑOS
36091			
POLEA DEL TENSOR			
CHEVROLET	C5500	CATERPILLAR 3116 DIESEL	1999-1999
CHEVROLET	C5500	CATERPILLAR 3126 DIESEL	1998-2002
CHEVROLET	C6500	CATERPILLAR 3116 DIESEL	1997-2000
CHEVROLET	C6500	CATERPILLAR 3126 DIESEL	1998-2003
CHEVROLET	C7500	CATERPILLAR 3116 DIESEL	1997-2000
CHEVROLET	C7500	CATERPILLAR 3126 DIESEL	1998-2003
CHEVROLET	C8500	CATERPILLAR 3116 DIESEL	1997-2000
CHEVROLET	C8500	CATERPILLAR 3126 DIESEL	1998-2003
CHEVROLET	KODIAK	CATERPILLAR 3116 DIESEL	1997-2000
CHEVROLET	KODIAK	CATERPILLAR 3126 DIESEL	2000-2008
FORD	F-650 SUPER DUTY	CATERPILLAR 3126 DIESEL	2000-2004
FORD	F-750 SUPER DUTY	CATERPILLAR 3126 DIESEL	2000-2004
FREIGHTLINER	ARGOSY	CATERPILLAR C10 DIESEL	1999-2003
FREIGHTLINER	ARGOSY	CATERPILLAR C10 DIESEL	2000-2003
FREIGHTLINER	ARGOSY	CATERPILLAR C10 DIESEL	2000-2003
FREIGHTLINER	ARGOSY	CATERPILLAR C12 DIESEL	1999-2004
FREIGHTLINER	ARGOSY	CATERPILLAR C12 DIESEL	2000-2004
FREIGHTLINER	ARGOSY	CATERPILLAR C12 DIESEL	2000-2004
FREIGHTLINER	ARGOSY	CATERPILLAR C15 DIESEL	2001-2004
FREIGHTLINER	ARGOSY	CATERPILLAR C15 DIESEL	2001-2004
FREIGHTLINER	BUSINESS CLASS M2	CATERPILLAR 3126 DIESEL	2007-2007
FREIGHTLINER	BUSINESS CLASS M2	CATERPILLAR C7 DIESEL	2004-2007
FREIGHTLINER	CENTURY CLASS	CATERPILLAR 3406 DIESEL	1998-1999
FREIGHTLINER	CENTURY CLASS	CATERPILLAR 3406 DIESEL	1998-1999
FREIGHTLINER	CENTURY CLASS	CATERPILLAR C10 DIESEL	1998-2003
FREIGHTLINER	CENTURY CLASS	CATERPILLAR C10 DIESEL	2000-2000
FREIGHTLINER	CENTURY CLASS	CATERPILLAR C10 DIESEL	2001-2003
FREIGHTLINER	CENTURY CLASS	CATERPILLAR C12 DIESEL	1998-2004
FREIGHTLINER	CENTURY CLASS	CATERPILLAR C12 DIESEL	2000-2000
FREIGHTLINER	CENTURY CLASS	CATERPILLAR C12 DIESEL	2001-2004
FREIGHTLINER	CENTURY CLASS	CATERPILLAR C15 DIESEL	2001-2004
FREIGHTLINER	CENTURY CLASS	CATERPILLAR C15 DIESEL	2004-2007
FREIGHTLINER	CENTURY CLASS	CATERPILLAR C15 DIESEL	2001-2006
FREIGHTLINER	CENTURY CLASS	CUMMINS ISM DIESEL	1998-2001
FREIGHTLINER	CLASSIC	CATERPILLAR C10 DIESEL	2001-2003
FREIGHTLINER	CLASSIC	CATERPILLAR C12 DIESEL	2001-2004
FREIGHTLINER	CLASSIC	CATERPILLAR C15 DIESEL	2001-2006
FREIGHTLINER	CLASSIC	CATERPILLAR C15 DIESEL	2004-2007
FREIGHTLINER	CLASSIC	CATERPILLAR C15 DIESEL	2001-2006
FREIGHTLINER	CLASSIC	CATERPILLAR C16 DIESEL	2001-2003
FREIGHTLINER	CLASSIC	CATERPILLAR C16 DIESEL	2001-2003
FREIGHTLINER	CLASSIC	CUMMINS ISM DIESEL	2001-2003



MARCA	MODELO	MOTOR	AÑOS
FREIGHTLINER	CLASSIC XL	CATERPILLAR C10 DIESEL	2001-2003
FREIGHTLINER	CLASSIC XL	CATERPILLAR C12 DIESEL	2001-2003
FREIGHTLINER	CLASSIC XL	CATERPILLAR C15 DIESEL	2001-2006
FREIGHTLINER	CLASSIC XL	CATERPILLAR C15 DIESEL	2004-2007
FREIGHTLINER	CLASSIC XL	CATERPILLAR C15 DIESEL	2001-2006
FREIGHTLINER	CLASSIC XL	CATERPILLAR C16 DIESEL	2001-2003
FREIGHTLINER	CLASSIC XL	CATERPILLAR C16 DIESEL	2001-2003
FREIGHTLINER	CLASSIC XL	CUMMINS ISM DIESEL	2001-2003
FREIGHTLINER	COLUMBIA	CATERPILLAR C10 DIESEL	2001-2003
FREIGHTLINER	COLUMBIA	CATERPILLAR C10 DIESEL	2001-2003
FREIGHTLINER	COLUMBIA	CATERPILLAR C12 DIESEL	2001-2004
FREIGHTLINER	COLUMBIA	CATERPILLAR C12 DIESEL	2003-2004
FREIGHTLINER	COLUMBIA	CATERPILLAR C12 DIESEL	2003-2004
FREIGHTLINER	COLUMBIA	CATERPILLAR C15 DIESEL	2001-2003
FREIGHTLINER	COLUMBIA	CATERPILLAR C15 DIESEL	2004-2008
FREIGHTLINER	COLUMBIA	CATERPILLAR C15 DIESEL	2001-2005
FREIGHTLINER	COLUMBIA	CATERPILLAR C16 DIESEL	2001-2004
FREIGHTLINER	COLUMBIA	CATERPILLAR C16 DIESEL	2001-2004
FREIGHTLINER	COLUMBIA	CUMMINS ISM DIESEL	2001-2003
FREIGHTLINER	CORONADO	CATERPILLAR C15 DIESEL	2002-2004
FREIGHTLINER	CORONADO	CATERPILLAR C15 DIESEL	2004-2007
FREIGHTLINER	CORONADO	CATERPILLAR C15 DIESEL	2002-2006
FREIGHTLINER	CORONADO	CATERPILLAR C16 DIESEL	2002-2003
FREIGHTLINER	CORONADO	CATERPILLAR C16 DIESEL	2002-2003
FREIGHTLINER	FL112	CATERPILLAR C10 DIESEL	1999-2004
FREIGHTLINER	FL112	CATERPILLAR C10 DIESEL	2000-2004
FREIGHTLINER	FL112	CATERPILLAR C10 DIESEL	2001-2004
FREIGHTLINER	FL112	CATERPILLAR C12 DIESEL	1999-2004
FREIGHTLINER	FL112	CATERPILLAR C12 DIESEL	2000-2004
FREIGHTLINER	FL112	CATERPILLAR C12 DIESEL	2001-2004
FREIGHTLINER	FL112	CUMMINS ISM DIESEL	1999-2003
FREIGHTLINER	FLD	CATERPILLAR 3406 DIESEL	1998-2000
FREIGHTLINER	FLD	CATERPILLAR 3406 DIESEL	1998-2000
FREIGHTLINER	FLD	CATERPILLAR C10 DIESEL	1997-2004
FREIGHTLINER	FLD	CATERPILLAR C10 DIESEL	2000-2000
FREIGHTLINER	FLD	CATERPILLAR C10 DIESEL	2001-2004
FREIGHTLINER	FLD	CATERPILLAR C12 DIESEL	1996-2004
FREIGHTLINER	FLD	CATERPILLAR C12 DIESEL	2000-2000
FREIGHTLINER	FLD	CATERPILLAR C12 DIESEL	2001-2004
FREIGHTLINER	FLD	CATERPILLAR C15 DIESEL	2000-2004
FREIGHTLINER	FLD	CATERPILLAR C15 DIESEL	2004-2008
FREIGHTLINER	FLD	CATERPILLAR C15 DIESEL	2008-2008
FREIGHTLINER	FLD	CATERPILLAR C15 DIESEL	2000-2007
FREIGHTLINER	FLD	CATERPILLAR C16 DIESEL	2000-2004
FREIGHTLINER	FLD	CATERPILLAR C16 DIESEL	2000-2004

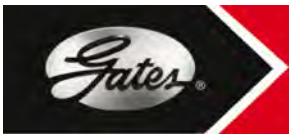

MASTER SERVICIO PESADO 2014

TENSORES Y
POLEAS

MARCA	MODELO	MOTOR	AÑOS	MARCA	MODELO	MOTOR	AÑOS
FREIGHTLINER	FLD	CUMMINS ISM DIESEL	1999-2003	INTERNATIONAL/NAVISTAR	5600I	CUMMINS ISM DIESEL	2002-2007
FREIGHTLINER	FLD	CUMMINS ISX DIESEL	2001-2001	INTERNATIONAL/NAVISTAR	5600I	INTERNATIONAL/NAVISTAR DT466	2001-2002
FREIGHTLINER	FLD120	CATERPILLAR C10 DIESEL	2001-2004	INTERNATIONAL/NAVISTAR	5600I	INTERNATIONAL/NAVISTAR DT466	2001-2002
FREIGHTLINER	FLD120	CATERPILLAR C10 DIESEL	2001-2004	INTERNATIONAL/NAVISTAR	5900I	CATERPILLAR C10 DIESEL	2000-2003
FREIGHTLINER	FLD120	CATERPILLAR C10 DIESEL	2001-2004	INTERNATIONAL/NAVISTAR	5900I	CATERPILLAR C12 DIESEL	2002-2004
FREIGHTLINER	FLD120	CATERPILLAR C12 DIESEL	2001-2004	INTERNATIONAL/NAVISTAR	5900I	CATERPILLAR C15 DIESEL	2004-2006
FREIGHTLINER	FLD120	CATERPILLAR C12 DIESEL	2001-2004	INTERNATIONAL/NAVISTAR	5900I	CUMMINS ISM DIESEL	2001-2006
FREIGHTLINER	FLD120	CATERPILLAR C12 DIESEL	2001-2004	INTERNATIONAL/NAVISTAR	7100	INTERNATIONAL/NAVISTAR DT466	1995-1995
FREIGHTLINER	FLD120	CATERPILLAR C7 DIESEL	2005-2005	INTERNATIONAL/NAVISTAR	7100	INTERNATIONAL/NAVISTAR DT466	1995-1995
FREIGHTLINER	FLD120	CUMMINS ISM DIESEL	2001-2002	INTERNATIONAL/NAVISTAR	7300	INTERNATIONAL/NAVISTAR DT466	2002-2003
INTERNATIONAL/NAVISTAR	3300	INTERNATIONAL/NAVISTAR DT466	2004-2004	INTERNATIONAL/NAVISTAR	7300	INTERNATIONAL/NAVISTAR DT466	2002-2003
INTERNATIONAL/NAVISTAR	3800	INTERNATIONAL/NAVISTAR DT466	1998-1999	INTERNATIONAL/NAVISTAR	7400	CUMMINS ISM DIESEL	2005-2005
INTERNATIONAL/NAVISTAR	3800	INTERNATIONAL/NAVISTAR DT466	2000-2001	INTERNATIONAL/NAVISTAR	7400	INTERNATIONAL/NAVISTAR 530 DIESEL	2002-2003
INTERNATIONAL/NAVISTAR	4300	INTERNATIONAL/NAVISTAR DT466	2002-2004	INTERNATIONAL/NAVISTAR	7400	INTERNATIONAL/NAVISTAR 530 DIESEL	2002-2003
INTERNATIONAL/NAVISTAR	4300	INTERNATIONAL/NAVISTAR DT466	2002-2004	INTERNATIONAL/NAVISTAR	7400	INTERNATIONAL/NAVISTAR DT466	2002-2003
INTERNATIONAL/NAVISTAR	4400	INTERNATIONAL/NAVISTAR 530 DIESEL	2002-2005	INTERNATIONAL/NAVISTAR	7400	INTERNATIONAL/NAVISTAR DT466	2002-2003
INTERNATIONAL/NAVISTAR	4400	INTERNATIONAL/NAVISTAR 530 DIESEL	2002-2005	INTERNATIONAL/NAVISTAR	7400	INTERNATIONAL/NAVISTAR DT530 DIESEL	2004-2005
INTERNATIONAL/NAVISTAR	4400	INTERNATIONAL/NAVISTAR DT466	2002-2005	INTERNATIONAL/NAVISTAR	7400	INTERNATIONAL/NAVISTAR DT530 DIESEL	2004-2005
INTERNATIONAL/NAVISTAR	4400	INTERNATIONAL/NAVISTAR DT466	2002-2005	INTERNATIONAL/NAVISTAR	7500	INTERNATIONAL/NAVISTAR 530 DIESEL	2002-2003
INTERNATIONAL/NAVISTAR	4700	INTERNATIONAL/NAVISTAR 530 DIESEL	1999-2002	INTERNATIONAL/NAVISTAR	7500	INTERNATIONAL/NAVISTAR 530 DIESEL	2002-2003
INTERNATIONAL/NAVISTAR	4700	INTERNATIONAL/NAVISTAR 530 DIESEL	1999-2002	INTERNATIONAL/NAVISTAR	7500	INTERNATIONAL/NAVISTAR DT466	2002-2002
INTERNATIONAL/NAVISTAR	4700	INTERNATIONAL/NAVISTAR DT408 DIESEL	1995-1997	INTERNATIONAL/NAVISTAR	7500	INTERNATIONAL/NAVISTAR DT466	2002-2002
INTERNATIONAL/NAVISTAR	4700	INTERNATIONAL/NAVISTAR DT408 DIESEL	1995-1997	INTERNATIONAL/NAVISTAR	7500	INTERNATIONAL/NAVISTAR DT530 DIESEL	2004-2005
INTERNATIONAL/NAVISTAR	4700	INTERNATIONAL/NAVISTAR DT466	1995-2002	INTERNATIONAL/NAVISTAR	7500	INTERNATIONAL/NAVISTAR DT530 DIESEL	2004-2005
INTERNATIONAL/NAVISTAR	4700	INTERNATIONAL/NAVISTAR DT466	1995-2002	INTERNATIONAL/NAVISTAR	7600	CATERPILLAR C10 DIESEL	2002-2004
INTERNATIONAL/NAVISTAR	4800	INTERNATIONAL/NAVISTAR 530 DIESEL	2002-2002	INTERNATIONAL/NAVISTAR	7600	CATERPILLAR C10 DIESEL	2002-2003
INTERNATIONAL/NAVISTAR	4800	INTERNATIONAL/NAVISTAR 530 DIESEL	2002-2002	INTERNATIONAL/NAVISTAR	7600	CATERPILLAR C12 DIESEL	2002-2004
INTERNATIONAL/NAVISTAR	4800	INTERNATIONAL/NAVISTAR DT408 DIESEL	1995-1997	INTERNATIONAL/NAVISTAR	7600	CATERPILLAR C12 DIESEL	2002-2003
INTERNATIONAL/NAVISTAR	4800	INTERNATIONAL/NAVISTAR DT408 DIESEL	1995-1997	INTERNATIONAL/NAVISTAR	7600	CUMMINS ISM DIESEL	2003-2007
INTERNATIONAL/NAVISTAR	4800	INTERNATIONAL/NAVISTAR DT466	1995-2003	INTERNATIONAL/NAVISTAR	7700	CUMMINS ISM DIESEL	2005-2006
INTERNATIONAL/NAVISTAR	4800	INTERNATIONAL/NAVISTAR DT466	1995-2003	INTERNATIONAL/NAVISTAR	8100	CATERPILLAR 3176 DIESEL	1995-1995
INTERNATIONAL/NAVISTAR	4900	INTERNATIONAL/NAVISTAR 530 DIESEL	1995-2002	INTERNATIONAL/NAVISTAR	8100	CATERPILLAR 3176 DIESEL	1996-1997
INTERNATIONAL/NAVISTAR	4900	INTERNATIONAL/NAVISTAR 530 DIESEL	1995-2002	INTERNATIONAL/NAVISTAR	8100	CATERPILLAR C10 DIESEL	2002-2003
INTERNATIONAL/NAVISTAR	4900	INTERNATIONAL/NAVISTAR DT408 DIESEL	1995-1997	INTERNATIONAL/NAVISTAR	8100	CATERPILLAR C10 DIESEL	2002-2003
INTERNATIONAL/NAVISTAR	4900	INTERNATIONAL/NAVISTAR DT408 DIESEL	1995-1997	INTERNATIONAL/NAVISTAR	8100	INTERNATIONAL/NAVISTAR 530 DIESEL	1995-1997
INTERNATIONAL/NAVISTAR	4900	INTERNATIONAL/NAVISTAR DT466	1995-2002	INTERNATIONAL/NAVISTAR	8100	INTERNATIONAL/NAVISTAR 530 DIESEL	1995-2003
INTERNATIONAL/NAVISTAR	4900	INTERNATIONAL/NAVISTAR DT466	1995-2002	INTERNATIONAL/NAVISTAR	8100	INTERNATIONAL/NAVISTAR 530 DIESEL	1999-2003
INTERNATIONAL/NAVISTAR	5000	CATERPILLAR C12 DIESEL	1998-1999	INTERNATIONAL/NAVISTAR	8100	INTERNATIONAL/NAVISTAR DT466	1995-2000
INTERNATIONAL/NAVISTAR	5500I	CATERPILLAR C10 DIESEL	2003-2004	INTERNATIONAL/NAVISTAR	8100	INTERNATIONAL/NAVISTAR DT466	1995-2000
INTERNATIONAL/NAVISTAR	5500I	CATERPILLAR C12 DIESEL	2003-2004	INTERNATIONAL/NAVISTAR	8200	DETROIT DIESEL 6 CIL, 11.1 L DIESEL	1995-1995
INTERNATIONAL/NAVISTAR	5500I	CUMMINS ISM DIESEL	2002-2006	INTERNATIONAL/NAVISTAR	8200	DETROIT DIESEL 6 CIL, 12.7 L DIESEL	1995-1995
INTERNATIONAL/NAVISTAR	5500I	INTERNATIONAL/NAVISTAR DT466	2001-2002	INTERNATIONAL/NAVISTAR	8200	INTERNATIONAL/NAVISTAR 530 DIESEL	1996-1997
INTERNATIONAL/NAVISTAR	5500I	INTERNATIONAL/NAVISTAR DT466	2001-2002	INTERNATIONAL/NAVISTAR	8200	INTERNATIONAL/NAVISTAR 530 DIESEL	1996-1997
INTERNATIONAL/NAVISTAR	5600I	CATERPILLAR C10 DIESEL	2002-2004	INTERNATIONAL/NAVISTAR	8200	INTERNATIONAL/NAVISTAR DT466	1997-1997
INTERNATIONAL/NAVISTAR	5600I	CATERPILLAR C12 DIESEL	2003-2004	INTERNATIONAL/NAVISTAR	8200	INTERNATIONAL/NAVISTAR DT466	1997-1997
INTERNATIONAL/NAVISTAR	5600I	CATERPILLAR C15 DIESEL	2004-2004	INTERNATIONAL/NAVISTAR	8500	INTERNATIONAL/NAVISTAR 530 DIESEL	2002-2005

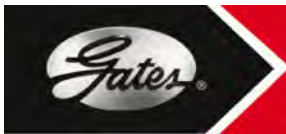

MASTER SERVICIO PESADO 2014

TENSORES Y POLEAS

MARCA	MODELO	MOTOR	AÑOS	MARCA	MODELO	MOTOR	AÑOS
INTERNATIONAL/NAVISTAR	8500	INTERNATIONAL/NAVISTAR 530 DIESEL	2002-2005	KENWORTH	T600	CATERPILLAR C15 DIESEL	2000-2005
INTERNATIONAL/NAVISTAR	8600	CATERPILLAR C10 DIESEL	2003-2004	KENWORTH	T600	CUMMINS ISM DIESEL	2005-2008
INTERNATIONAL/NAVISTAR	8600	CATERPILLAR C10 DIESEL	2003-2004	KENWORTH	T800	CATERPILLAR C10 DIESEL	1997-2004
INTERNATIONAL/NAVISTAR	8600	CATERPILLAR C12 DIESEL	2003-2004	KENWORTH	T800	CATERPILLAR C10 DIESEL	1997-2004
INTERNATIONAL/NAVISTAR	8600	CATERPILLAR C12 DIESEL	2003-2004	KENWORTH	T800	CATERPILLAR C12 DIESEL	1996-2004
INTERNATIONAL/NAVISTAR	8600	CUMMINS ISM DIESEL	2003-2007	KENWORTH	T800	CATERPILLAR C12 DIESEL	1996-2004
INTERNATIONAL/NAVISTAR	9200	CATERPILLAR 3176 DIESEL	1995-1995	KENWORTH	T800	CATERPILLAR C15 DIESEL	2004-2004
INTERNATIONAL/NAVISTAR	9200I	CATERPILLAR C10 DIESEL	2004-2004	KENWORTH	T800	CATERPILLAR C15 DIESEL	2004-2007
INTERNATIONAL/NAVISTAR	9200I	CATERPILLAR C10 DIESEL	2004-2004	KENWORTH	T800	CATERPILLAR C15 DIESEL	2004-2004
INTERNATIONAL/NAVISTAR	9200I	CATERPILLAR C12 DIESEL	2003-2004	KENWORTH	T800	CUMMINS ISM DIESEL	2003-2006
INTERNATIONAL/NAVISTAR	9200I	CATERPILLAR C12 DIESEL	2004-2004	KENWORTH	T800	CUMMINS ISM DIESEL	2007-2007
INTERNATIONAL/NAVISTAR	9200I	CUMMINS ISM DIESEL	2003-2007	KENWORTH	W900	CATERPILLAR C10 DIESEL	1997-2004
INTERNATIONAL/NAVISTAR	9300	CATERPILLAR 3176 DIESEL	1995-1995	KENWORTH	W900	CATERPILLAR C12 DIESEL	2000-2004
INTERNATIONAL/NAVISTAR	9400	CATERPILLAR 3176 DIESEL	1995-1997	KENWORTH	W900	CATERPILLAR C15 DIESEL	2004-2010
INTERNATIONAL/NAVISTAR	9400I	CATERPILLAR C15 DIESEL	2004-2006	KENWORTH	W900	CATERPILLAR C15 DIESEL	2004-2007
INTERNATIONAL/NAVISTAR	9400I	CATERPILLAR C15 DIESEL	2007-2007	KENWORTH	W900	CUMMINS ISM DIESEL	2003-2006
INTERNATIONAL/NAVISTAR	9400I	CATERPILLAR C15 DIESEL	2004-2007	STERLING	ACTERRA	CATERPILLAR 3126 DIESEL	2003-2003
INTERNATIONAL/NAVISTAR	9400I	CUMMINS ISM DIESEL	2004-2007	STERLING	ACTERRA	CATERPILLAR 3126 DIESEL	2001-2004
INTERNATIONAL/NAVISTAR	9900I	CATERPILLAR C12 DIESEL	2003-2004	STERLING	ACTERRA	CATERPILLAR C7 DIESEL	2004-2007
INTERNATIONAL/NAVISTAR	9900I	CATERPILLAR C15 DIESEL	2004-2008	STERLING	A-LINE	CATERPILLAR C10 DIESEL	2002-2004
INTERNATIONAL/NAVISTAR	9900I	CATERPILLAR C15 DIESEL	2004-2008	STERLING	A-LINE	CATERPILLAR C10 DIESEL	2002-2004
INTERNATIONAL/NAVISTAR	9900IX	CATERPILLAR C12 DIESEL	2003-2003	STERLING	A-LINE	CATERPILLAR C12 DIESEL	2002-2004
INTERNATIONAL/NAVISTAR	9900IX	CATERPILLAR C15 DIESEL	2004-2007	STERLING	A-LINE	CATERPILLAR C12 DIESEL	2002-2004
INTERNATIONAL/NAVISTAR	9900IX	CATERPILLAR C15 DIESEL	2004-2007	STERLING	A-LINE	CATERPILLAR C15 DIESEL	2004-2007
INTERNATIONAL/NAVISTAR	CE	INTERNATIONAL/NAVISTAR DT466	2003-2004	STERLING	L-LINE	CATERPILLAR 3126 DIESEL	2001-2003
INTERNATIONAL/NAVISTAR	CONVENTIONAL IC	INTERNATIONAL/NAVISTAR DT466	2002-2003	STERLING	L-LINE	CATERPILLAR 3126 DIESEL	2000-2004
INTERNATIONAL/NAVISTAR	FE	INTERNATIONAL/NAVISTAR DT466	2002-2004	STERLING	L-LINE	CATERPILLAR C15 DIESEL	2004-2007
INTERNATIONAL/NAVISTAR	PAYSTAR 5600i	CATERPILLAR C15 DIESEL	2008-2008	STERLING	L-LINE	CATERPILLAR C7 DIESEL	2005-2007
INTERNATIONAL/NAVISTAR	PAYSTAR 5600I	CATERPILLAR C15 DIESEL	2008-2008	STERLING	L-LINE	CATERPILLAR C7 DIESEL	2004-2004
INTERNATIONAL/NAVISTAR	RE	INTERNATIONAL/NAVISTAR 530 DIESEL	1998-2004	STERLING	L-LINE	CATERPILLAR C9 DIESEL	2006-2006
INTERNATIONAL/NAVISTAR	TRANSTAR 8600	CUMMINS ISM DIESEL	2008-2008	STERLING	L-LINE	CUMMINS ISC DIESEL	2000-2003
INTERNATIONAL/NAVISTAR	WORKSTAR 7600	CUMMINS ISM DIESEL	2008-2008	VOLVO	AUTOCAR	DETROIT DIESEL 6 CIL, 11.1 L DIESEL	1998-1998
KENWORTH	C500	CATERPILLAR C15 DIESEL	2007-2008	VOLVO	AUTOCAR	DETROIT DIESEL 6 CIL, 12.7 L DIESEL	1998-1998
KENWORTH	C500	CATERPILLAR C15 DIESEL	2007-2008	VOLVO	VNL	CATERPILLAR 3406 DIESEL	1999-1999
KENWORTH	T2000	CATERPILLAR C10 DIESEL	1997-1999	VOLVO	VNL	DETROIT DIESEL 6 CIL, 11.1 L DIESEL	1998-2001
KENWORTH	T2000	CATERPILLAR C12 DIESEL	1997-1999	VOLVO	VNL	DETROIT DIESEL 6 CIL, 12.7 L DIESEL	1998-2001
KENWORTH	T2000	CATERPILLAR C15 DIESEL	2004-2010				
KENWORTH	T2000	CATERPILLAR C15 DIESEL	2004-2010				
KENWORTH	T300	CATERPILLAR 3126 DIESEL	1996-2003				
KENWORTH	T300	CATERPILLAR C7 DIESEL	2004-2006				
KENWORTH	T600	CATERPILLAR C10 DIESEL	1997-2004	FREIGHTLINER	ARGOSY	CUMMINS ISX DIESEL	1999-2003
KENWORTH	T600	CATERPILLAR C10 DIESEL	1997-2004	FREIGHTLINER	CENTURY CLASS	CUMMINS ISX DIESEL	2001-2001
KENWORTH	T600	CATERPILLAR C12 DIESEL	1996-2004	FREIGHTLINER	CENTURY CLASS	CUMMINS ISX DIESEL	2000-2000
KENWORTH	T600	CATERPILLAR C12 DIESEL	1996-2004	FREIGHTLINER	COLUMBIA	CUMMINS ISX DIESEL	2001-2001
KENWORTH	T600	CATERPILLAR C15 DIESEL	2006-2006	FREIGHTLINER	FLD	CUMMINS ISX DIESEL	1999-2003
KENWORTH	T600	CATERPILLAR C15 DIESEL	2000-2008	INTERNATIONAL/NAVISTAR	9100	DETROIT DIESEL SERIE 60	1998-1999



36092
POLEA DEL TENSOR

MARCA	MODELO	MOTOR	AÑOS	MARCA	MODELO	MOTOR	AÑOS		
INTERNATIONAL/NAVISTAR	9100I	CUMMINS ISX DIESEL	2001-2003	MACK	CV SERIES	MACK AMI DIESEL	2004-2006		
INTERNATIONAL/NAVISTAR	9100I	DETROIT DIESEL 6 CIL, 12.7 L DIESEL	2001-2003	MACK	CX SERIES	MACK 6 CIL, 12.0 L DIESEL	2001-2002		
INTERNATIONAL/NAVISTAR	9100I	DETROIT DIESEL SERIE 60	2000-2000	MACK	CX SERIES	MACK AC DIESEL	2003-2006		
INTERNATIONAL/NAVISTAR	9200	DETROIT DIESEL 6 CIL, 11.1 L DIESEL	1995-1997	MACK	CXN SERIES	MACK AC DIESEL	2006-2007		
INTERNATIONAL/NAVISTAR	9200	DETROIT DIESEL 6 CIL, 12.7 L DIESEL	1995-1997	MACK	DM SERIES	MACK 6 CIL, 12.0 L DIESEL	2001-2001		
INTERNATIONAL/NAVISTAR	9200	DETROIT DIESEL SERIE 60	1998-1999	MACK	LE SERIES	MACK AI DIESEL	2003-2005		
INTERNATIONAL/NAVISTAR	9200I	CUMMINS SIGNATURE 600 DIESEL	2000-2002	MACK	MR SERIES	MACK 6 CIL, 12.0 L DIESEL	2001-2002		
INTERNATIONAL/NAVISTAR	9200I	DETROIT DIESEL 6 CIL, 12.7 L DIESEL	2001-2001	MACK	RD SERIES	MACK 6 CIL, 12.0 L DIESEL	2001-2002		
INTERNATIONAL/NAVISTAR	9200I	DETROIT DIESEL SERIE 60	2000-2000	STERLING	L-LINE	CUMMINS ISX DIESEL	2001-2001		
INTERNATIONAL/NAVISTAR	9400	DETROIT DIESEL 6 CIL, 11.1 L DIESEL	1995-1996	STERLING	L-LINE	CUMMINS SIGNATURE 600 DIESEL	2001-2001		
INTERNATIONAL/NAVISTAR	9400	DETROIT DIESEL 6 CIL, 12.7 L DIESEL	1995-1996	STERLING	L-LINE	CUMMINS SIGNATURE 600 DIESEL	2001-2001		
INTERNATIONAL/NAVISTAR	9400	DETROIT DIESEL SERIE 60	1997-1999	VOLVO	VHD	CUMMINS ISM DIESEL	2002-2003		
INTERNATIONAL/NAVISTAR	9400I	CUMMINS ISX DIESEL	2000-2002	VOLVO	VNL	CUMMINS ISM DIESEL	2002-2003		
INTERNATIONAL/NAVISTAR	9400I	DETROIT DIESEL 6 CIL, 12.7 L DIESEL	2001-2001	VOLVO	VNL	CUMMINS ISX DIESEL	2000-2003		
INTERNATIONAL/NAVISTAR	9400I	DETROIT DIESEL SERIE 60	2000-2000	VOLVO	VNL	CUMMINS SIGNATURE 600 DIESEL	2003-2003		
INTERNATIONAL/NAVISTAR	9600	DETROIT DIESEL 6 CIL, 11.1 L DIESEL	1996-1996		36093 POLEA DEL TENSOR	FORD	F-650 SUPER DUTY	CUMMINS ISB DIESEL	2002-2004
INTERNATIONAL/NAVISTAR	9600	DETROIT DIESEL 6 CIL, 12.7 L DIESEL	1995-1995			FORD	F-650 SUPER DUTY	CUMMINS ISB DIESEL	2000-2000
INTERNATIONAL/NAVISTAR	9700	DETROIT DIESEL 6 CIL, 11.1 L DIESEL	1996-1996			FORD	F-650 SUPER DUTY	CUMMINS ISB DIESEL	2001-2001
INTERNATIONAL/NAVISTAR	9700	DETROIT DIESEL 6 CIL, 12.7 L DIESEL	1996-1996			FORD	F-750 SUPER DUTY	CUMMINS ISB DIESEL	2002-2004
INTERNATIONAL/NAVISTAR	9800	DETROIT DIESEL SERIE 60	1997-1997	FORD	F-750 SUPER DUTY	CUMMINS ISB DIESEL	2000-2000		
INTERNATIONAL/NAVISTAR	9900	DETROIT DIESEL SERIE 60	1999-1999	FORD	F-750 SUPER DUTY	CUMMINS ISB DIESEL	2001-2001		
INTERNATIONAL/NAVISTAR	9900I	CUMMINS ISX DIESEL	2000-2002	FREIGHTLINER	BUSINESS CLASS M2	CATERPILLAR C13 DIESEL	2004-2007		
INTERNATIONAL/NAVISTAR	9900I	DETROIT DIESEL 6 CIL, 12.7 L DIESEL	2001-2001	FREIGHTLINER	BUSINESS CLASS M2	CUMMINS ISC DIESEL	2004-2004		
INTERNATIONAL/NAVISTAR	9900I	DETROIT DIESEL SERIE 60	2000-2000	FREIGHTLINER	CENTURY CLASS	CATERPILLAR C11 DIESEL	2004-2006		
INTERNATIONAL/NAVISTAR	9900IX	CUMMINS ISX DIESEL	2000-2003	FREIGHTLINER	CENTURY CLASS	CATERPILLAR C13 DIESEL	2004-2007		
INTERNATIONAL/NAVISTAR	9900IX	DETROIT DIESEL 6 CIL, 12.7 L DIESEL	2001-2001	FREIGHTLINER	CENTURY CLASS	CATERPILLAR C15 DIESEL	2004-2007		
INTERNATIONAL/NAVISTAR	9900IX	DETROIT DIESEL SERIE 60	2000-2000	FREIGHTLINER	CLASSIC	CATERPILLAR C11 DIESEL	2004-2006		
INTERNATIONAL/NAVISTAR	CONVENTIONAL IC	INTERNATIONAL/NAVISTAR T444 DIESEL	2003-2003	FREIGHTLINER	CLASSIC	CATERPILLAR C13 DIESEL	2004-2007		
KENWORTH	T2000	CUMMINS ISX DIESEL	1999-2003	FREIGHTLINER	CLASSIC	CATERPILLAR C15 DIESEL	2004-2007		
KENWORTH	T600	CUMMINS SIGNATURE 600 DIESEL	2003-2003	FREIGHTLINER	CLASSIC XL	CATERPILLAR C11 DIESEL	2004-2006		
KENWORTH	T800	CUMMINS ISX DIESEL	1999-2003	FREIGHTLINER	CLASSIC XL	CATERPILLAR C13 DIESEL	2004-2006		
KENWORTH	W900	CUMMINS ISX DIESEL	1999-2003	FREIGHTLINER	COLUMBIA	CATERPILLAR C11 DIESEL	2004-2007		
KENWORTH	W900	CUMMINS SIGNATURE 600 DIESEL	2000-2002	FREIGHTLINER	COLUMBIA	CATERPILLAR C13 DIESEL	2004-2007		
MACK	CH SERIES	CUMMINS SIGNATURE 600 DIESEL	2001-2003	FREIGHTLINER	COLUMBIA	CATERPILLAR C15 DIESEL	2004-2008		
MACK	CH SERIES	MACK 6 CIL, 12.0 L DIESEL	2001-2002	FREIGHTLINER	CORONADO	CATERPILLAR C15 DIESEL	2004-2007		
MACK	CH SERIES	MACK AC DIESEL	2003-2006	FREIGHTLINER	FLD	CATERPILLAR C11 DIESEL	2004-2007		
MACK	CHN SERIES	MACK AC DIESEL	2006-2007	FREIGHTLINER	FLD	CATERPILLAR C13 DIESEL	2004-2007		
MACK	CL SERIES	CUMMINS SIGNATURE 600 DIESEL	2001-2003	FREIGHTLINER	FLD	CATERPILLAR C15 DIESEL	2004-2007		
MACK	CL SERIES	MACK 6 CIL, 12.0 L DIESEL	2001-2001	FREIGHTLINER	FLD120	CATERPILLAR C11 DIESEL	2004-2005		
MACK	CS SERIES	MACK AC DIESEL	2003-2003	FREIGHTLINER	FLD120	CATERPILLAR C13 DIESEL	2004-2005		
MACK	CT SERIES	MACK AI DIESEL	2006-2007	INTERNATIONAL/NAVISTAR	5500I	CATERPILLAR C13 DIESEL	2005-2007		
MACK	CT SERIES	MACK AMI DIESEL	2006-2006						
MACK	CV SERIES	MACK 6 CIL, 12.0 L DIESEL	2001-2002						
MACK	CV SERIES	MACK AI DIESEL	2003-2003						
MACK	CV SERIES	MACK AI DIESEL	2006-2007						
MACK	CV SERIES	MACK AMI DIESEL	2003-2004						



MASTER SERVICIO PESADO 2014

TENSORES Y POLEAS

MARCA	MODELO	MOTOR	AÑOS	MARCA	MODELO	MOTOR	AÑOS
INTERNATIONAL/NAVISTAR	5600I	CATERPILLAR C13 DIESEL	2005-2007	KENWORTH	W900	CUMMINS ISX DIESEL	1999-2003
INTERNATIONAL/NAVISTAR	5900I	CATERPILLAR C13 DIESEL	2005-2007	KENWORTH	W900	CUMMINS SIGNATURE 600 DIESEL	2000-2002
INTERNATIONAL/NAVISTAR	7700	CATERPILLAR C13 DIESEL	2005-2007	MACK	CH SERIES	CUMMINS SIGNATURE 600 DIESEL	2001-2003
INTERNATIONAL/NAVISTAR	8600	CATERPILLAR C13 DIESEL	2004-2007	MACK	CL SERIES	CUMMINS SIGNATURE 600 DIESEL	2001-2003
INTERNATIONAL/NAVISTAR	9400I	CATERPILLAR C15 DIESEL	2004-2006	STERLING	L-LINE	CUMMINS ISX DIESEL	2001-2001
INTERNATIONAL/NAVISTAR	9900I	CATERPILLAR C13 DIESEL	2004-2006	STERLING	L-LINE	CUMMINS SIGNATURE 600 DIESEL	2001-2001
INTERNATIONAL/NAVISTAR	9900IX	CATERPILLAR C15 DIESEL	2004-2007	STERLING	L-LINE	CUMMINS SIGNATURE 600 DIESEL	2001-2001
INTERNATIONAL/NAVISTAR	PAYSTAR 5600I	CATERPILLAR C15 DIESEL	2008-2008	VOLVO	VNL	CUMMINS ISX DIESEL	2000-2003
INTERNATIONAL/NAVISTAR	TRANSTAR 8500	CATERPILLAR C13 DIESEL	2008-2008	VOLVO	VNL	CUMMINS SIGNATURE 600 DIESEL	2003-2003
INTERNATIONAL/NAVISTAR	TRANSTAR 8600	CATERPILLAR C13 DIESEL	2008-2008				
INTERNATIONAL/NAVISTAR	WORKSTAR 7700	CATERPILLAR C13 DIESEL	2008-2008				
KENWORTH	T300	CUMMINS ISC DIESEL	1998-2004				36096 POLEA
KENWORTH	T600	CATERPILLAR C15 DIESEL	2000-2006	CHEVROLET	C5500	CATERPILLAR 3126 DIESEL	1998-2002
KENWORTH	T800	CATERPILLAR C13 DIESEL	2004-2007	CHEVROLET	C6500	CATERPILLAR 3126 DIESEL	1998-2003
KENWORTH	T800	CATERPILLAR C15 DIESEL	2004-2007	CHEVROLET	C6500	CATERPILLAR C7 DIESEL	2004-2007
KENWORTH	T800	CUMMINS ISL	2006-2006	CHEVROLET	C7500	CATERPILLAR 3126 DIESEL	1998-2003
KENWORTH	T800	CUMMINS ISL DIESEL	2001-2009	CHEVROLET	C7500	CATERPILLAR C7 DIESEL	2004-2007
KENWORTH	W900	CATERPILLAR C11 DIESEL	2005-2007	CHEVROLET	C7500	CATERPILLAR C7 DIESEL	2004-2007
KENWORTH	W900	CATERPILLAR C15 DIESEL	2004-2007	CHEVROLET	C8500	CATERPILLAR 3126 DIESEL	1998-2003
KENWORTH	W900	CUMMINS ISC DIESEL	2003-2004	CHEVROLET	C8500	CATERPILLAR C7 DIESEL	2004-2007
STERLING	ACTERRA	CATERPILLAR C13 DIESEL	2004-2006	CHEVROLET	KODIAK	CATERPILLAR 3116 DIESEL	1997-2000
STERLING	ACTERRA	CUMMINS ISC DIESEL	2005-2008	CHEVROLET	KODIAK	CATERPILLAR 3126 DIESEL	2000-2008
STERLING	A-LINE	CATERPILLAR C11 DIESEL	2004-2007	FREIGHTLINER	BUSINESS CLASS M2	CATERPILLAR 3126 DIESEL	2007-2007
STERLING	A-LINE	CATERPILLAR C13 DIESEL	2004-2007	FREIGHTLINER	BUSINESS CLASS M2	CATERPILLAR C7 DIESEL	2007-2007
STERLING	A-LINE	CATERPILLAR C15 DIESEL	2004-2007	KENWORTH	T300	CATERPILLAR C7 DIESEL	2004-2007
STERLING	L-LINE	CATERPILLAR C11 DIESEL	2004-2007	STERLING	ACTERRA	CATERPILLAR 3126 DIESEL	2001-2004
STERLING	L-LINE	CATERPILLAR C13 DIESEL	2004-2007	STERLING	ACTERRA	CATERPILLAR C7 DIESEL	2004-2007
STERLING	L-LINE	CATERPILLAR C15 DIESEL	2004-2007				
STERLING	L-LINE	CUMMINS ISB DIESEL	2000-2000				36098 POLEA DEL TENSOR
				VOLVO	VNL	CUMMINS N14 DIESEL	2000-2003
							36157 POLEA
FORD	F-600	CUMMINS B Series 5.9 L DIESEL	1992-1994	FORD	E450 SUPER DUTY	FORD V10, 6.8 L	2006-2009
FREIGHTLINER	ARGOSY	CUMMINS ISX DIESEL	1999-2003	FORD	F-350 SUPER DUTY	V8, 5.4 L	2007-2009
FREIGHTLINER	CENTURY CLASS	CUMMINS ISX DIESEL	2000-2001	FORD	F-450 SUPER DUTY	FORD V10, 6.8 L	2002-2006
FREIGHTLINER	COLUMBIA	CUMMINS ISX DIESEL	2001-2001	FORD	F-450 SUPER DUTY	V10, 6.8 L	2007-2007
FREIGHTLINER	FLD	CUMMINS ISX DIESEL	1999-2003	FORD	F-550 SUPER DUTY	FORD V10, 6.8 L	2002-2006
INTERNATIONAL/NAVISTAR	9100I	CUMMINS ISX DIESEL	2001-2003				
INTERNATIONAL/NAVISTAR	9200I	CUMMINS SIGNATURE 600 DIESEL	2000-2002				36164 POLEA DEL TENSOR
INTERNATIONAL/NAVISTAR	9400I	CUMMINS ISX DIESEL	2000-2002	FREIGHTLINER	COLUMBIA	CATERPILLAR C13 DIESEL	2008-2009
INTERNATIONAL/NAVISTAR	9900I	CUMMINS ISX DIESEL	2000-2002	INTERNATIONAL/NAVISTAR	7600	CATERPILLAR C13 DIESEL	2004-2008
INTERNATIONAL/NAVISTAR	9900IX	CUMMINS ISX DIESEL	2000-2003				
KENWORTH	T2000	CUMMINS ISX DIESEL	1999-2003				
KENWORTH	T600	CUMMINS SIGNATURE 600 DIESEL	2003-2003				
KENWORTH	T800	CUMMINS ISX DIESEL	1999-2003				



MASTER SERVICIO PESADO 2014

TENSORES Y POLEAS

MARCA	MODELO	MOTOR	AÑOS
INTERNATIONAL/NAVISTAR	92001	CATERPILLAR C13 DIESEL	2004-2008
INTERNATIONAL/NAVISTAR	94001	CATERPILLAR C13 DIESEL	2004-2007
INTERNATIONAL/NAVISTAR	DURASTAR 4300	INTERNATIONAL/NAVISTAR MAXXFORCE DT DIESEL	2010-2013
INTERNATIONAL/NAVISTAR	DURASTAR 4400	INTERNATIONAL/NAVISTAR MAXXFORCE DT DIESEL	2008-2013
INTERNATIONAL/NAVISTAR	WORKSTAR 7400	INTERNATIONAL/NAVISTAR MAXXFORCE 9 DIESEL	2010-2012
INTERNATIONAL/NAVISTAR	WORKSTAR 7400	INTERNATIONAL/NAVISTAR MAXXFORCE 9 DIESEL	2010-2012
KENWORTH	T800	CATERPILLAR C11 DIESEL	2003-2009
KENWORTH	T800	CATERPILLAR C13 DIESEL	2004-2007
KENWORTH	W900	CATERPILLAR C13 DIESEL	2004-2007



36165
POLEA

INTERNATIONAL/NAVISTAR	92001	CUMMINS ISX DIESEL	2003-2010
INTERNATIONAL/NAVISTAR	94001	CUMMINS ISX DIESEL	2004-2007
INTERNATIONAL/NAVISTAR	99001	CUMMINS ISX DIESEL	2003-2008
KENWORTH	T600	CUMMINS ISX DIESEL	2002-2010
KENWORTH	T660	CATERPILLAR C15 DIESEL	2007-2013
KENWORTH	T660	CUMMINS ISX DIESEL	2007-2014
VOLVO	VNL	CUMMINS ISX DIESEL	2004-2013
VOLVO	VNM	CUMMINS ISX DIESEL	2006-2013



36222
POLEA

NISSAN	NV2500	V6, 4.0 L	2013-2014
--------	--------	-----------	-----------



36223
POLEA

INTERNATIONAL/NAVISTAR	92001	CUMMINS ISX DIESEL	2003-2013
INTERNATIONAL/NAVISTAR	94001	CUMMINS ISX DIESEL	2004-2007
INTERNATIONAL/NAVISTAR	99001	CUMMINS ISX DIESEL	2003-2008
INTERNATIONAL/NAVISTAR	PROSTAR SERIES	CUMMINS ISX DIESEL	2009-2012
INTERNATIONAL/NAVISTAR	PROSTAR SERIES	CUMMINS ISX DIESEL	2007-2008
KENWORTH	T600	CUMMINS ISX DIESEL	2002-2010
KENWORTH	T660	CUMMINS ISX DIESEL	2007-2014
KENWORTH	W900	CUMMINS ISX DIESEL	2010-2013
VOLVO	VNL	CUMMINS ISX DIESEL	2004-2013
VOLVO	VNM	CUMMINS ISX DIESEL	2006-2013



36225
POLEA

INTERNATIONAL/NAVISTAR	92001	CUMMINS ISM DIESEL	2003-2007
INTERNATIONAL/NAVISTAR	94001	CUMMINS ISM DIESEL	2004-2007
INTERNATIONAL/NAVISTAR	WORKSTAR 7600	CUMMINS ISM DIESEL	2008-2010

FREIGHTLINER	BUSINESS CLASS M2	CATERPILLAR C13 DIESEL	2009-2010
FREIGHTLINER	BUSINESS CLASS M2	CATERPILLAR C13 DIESEL	2009-2010
KENWORTH	T660	CATERPILLAR C13 DIESEL	2009-2013

36227
POLEA



36234
POLEA

FORD	F-450 SUPER DUTY	V8, 6.4 L DIESEL	2009-2010
FORD	F-450 SUPER DUTY	V8, 6.4 L DIESEL	2009-2010
FORD	F-550 SUPER DUTY	V8, 6.4 L DIESEL	2008-2010



36269
POLEA

FREIGHTLINER	COLUMBIA	CATERPILLAR C13 DIESEL	2008-2009
INTERNATIONAL/NAVISTAR	7600	CATERPILLAR C13 DIESEL	2004-2008
INTERNATIONAL/NAVISTAR	92001	CATERPILLAR C13 DIESEL	2004-2008
INTERNATIONAL/NAVISTAR	94001	CATERPILLAR C13 DIESEL	2004-2007
KENWORTH	T800	CATERPILLAR C11 DIESEL	2003-2009
KENWORTH	T800	CATERPILLAR C13 DIESEL	2004-2007
KENWORTH	W900	CATERPILLAR C13 DIESEL	2004-2007



36282
POLEA

FREIGHTLINER	COLUMBIA	CATERPILLAR C15 DIESEL	2008-2009
FREIGHTLINER	FLD	CATERPILLAR C15 DIESEL	2009-2010



36283
POLEA

FREIGHTLINER	BUSINESS CLASS M2	CUMMINS ISC DIESEL	2007-2011
KENWORTH	T300	CUMMINS ISC DIESEL	2006-2008



36285
POLEA

MACK	GU SERIES	MACK MP8 DIESEL	2008-2010
------	-----------	-----------------	-----------



36286
POLEA

VOLVO	VHD	VOLVO VE D12 DIESEL	2005-2006
VOLVO	VHD	VOLVO VE D12 DIESEL	2007-2009

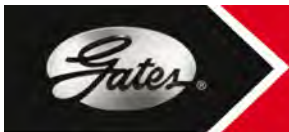

MASTER SERVICIO PESADO 2014

TENSORES Y POLEAS

MARCA	MODELO	MOTOR	AÑOS
VOLVO	VNL	CUMMINS ISX DIESEL	2004-2013
VOLVO	VNL	VOLVO VE D12 DIESEL	2004-2008
VOLVO	VNM	CUMMINS ISX DIESEL	2006-2013
VOLVO	VNM	VOLVO VE D12 DIESEL	2006-2008



36308
POLEA

INTERNATIONAL/NAVISTAR	9200I	CUMMINS ISM DIESEL	2003-2007
INTERNATIONAL/NAVISTAR	9400I	CUMMINS ISM DIESEL	2004-2007
INTERNATIONAL/NAVISTAR	PROSTAR SERIES	CUMMINS ISX DIESEL	2007-2008
INTERNATIONAL/NAVISTAR	WORKSTAR 7600	CUMMINS ISM DIESEL	2008-2010
KENWORTH	T600	CUMMINS ISM DIESEL	2005-2008



36315
POLEA

DODGE	RAM-4000	V6, 5.9 L DIESEL	2008-2008
DODGE	RAM-4000	V6, 6.7 L DIESEL	2008-2013



36341
POLEA

FREIGHTLINER	COLUMBIA	CATERPILLAR C13 DIESEL	2008-2009
FREIGHTLINER	COLUMBIA	CATERPILLAR C15 DIESEL	2006-2007
FREIGHTLINER	FLD	CATERPILLAR C15 DIESEL	2008-2008
INTERNATIONAL/NAVISTAR	7600	CATERPILLAR C13 DIESEL	2004-2008
INTERNATIONAL/NAVISTAR	9200I	CATERPILLAR C13 DIESEL	2004-2008
INTERNATIONAL/NAVISTAR	9400I	CATERPILLAR C13 DIESEL	2004-2007
INTERNATIONAL/NAVISTAR	9400I	CATERPILLAR C15 DIESEL	2007-2007
INTERNATIONAL/NAVISTAR	9900I	CATERPILLAR C13 DIESEL	2004-2008
INTERNATIONAL/NAVISTAR	9900I	CATERPILLAR C15 DIESEL	2004-2008
KENWORTH	C500	CATERPILLAR C15 DIESEL	2007-2008
KENWORTH	T600	CATERPILLAR C15 DIESEL	2007-2008
KENWORTH	T800	CATERPILLAR C11 DIESEL	2003-2009
KENWORTH	T800	CATERPILLAR C13 DIESEL	2004-2007
KENWORTH	W900	CATERPILLAR C13 DIESEL	2004-2007
KENWORTH	W900	CATERPILLAR C15 DIESEL	2008-2010



36351
POLEA

INTERNATIONAL/NAVISTAR	BE	INTERNATIONAL/NAVISTAR MAXXFORCE 7 DIESEL	2008-2013
INTERNATIONAL/NAVISTAR	DURASTAR 4300	INTERNATIONAL/NAVISTAR MAXXFORCE 7 DIESEL	2011-2012

MARCA	MODELO	MOTOR	AÑOS
FORD	F-450 SUPER DUTY	V8, 6.4 L DIESEL	2008-2008



36354
POLEA

CHEVROLET	C4500	GM V8 8.1 L	2008-2008
CHEVROLET	C4500	GM V8 8.1 L	2003-2006
CHEVROLET	C4500	GM V8 8.1 L	2007-2007
CHEVROLET	C4500	GM V8 8.1 L	2003-2006
CHEVROLET	C5500	GM V8 8.1 L	2008-2008
CHEVROLET	C5500	GM V8 8.1 L	2003-2006
CHEVROLET	C5500	GM V8 8.1 L	2007-2007
CHEVROLET	C5500	GM V8 8.1 L	2003-2006
CHEVROLET	S-10	4 CIL, 2.2 L	1995-1997
CHEVROLET	S-10	4 CIL, 2.2 L	1994-1994
CHEVROLET	S-10	V6, 4.3 L	1996-2002
CHEVROLET	S-10	V6, 4.3 L	1995-1995
CHEVROLET	S-10	V6, 4.3 L	1992-1994

FORD	E450 SUPER DUTY	FORD V10, 6.8 L	2002-2005
FORD	E450 SUPER DUTY	FORD V10, 6.8 L	2006-2009
FORD	E550 SUPER DUTY	FORD V10, 6.8 L	2002-2003
FORD	F-350 SUPER DUTY	V8, 5.4 L	2004-2010
FORD	F-350 SUPER DUTY	V8, 5.4 L	2010-2010
FORD	F-450 SUPER DUTY	FORD V10, 6.8 L	2002-2006
FORD	F-450 SUPER DUTY	V10, 6.8 L	2008-2013
FORD	F-450 SUPER DUTY	V10, 6.8 L	2007-2010
FORD	F-450 SUPER DUTY	V10, 6.8 L	2007-2007
FORD	F-450 SUPER DUTY	V8, 7.5 L	1997-1997
FORD	F-550 SUPER DUTY	FORD V10, 6.8 L	2002-2006
FORD	F-550 SUPER DUTY	V10, 6.8 L	2008-2010
FORD	RANGER	4 CIL, 2.3 L	2002-2004
FORD	RANGER	4 CIL, 2.5 L	1998-2001
FORD	RANGER	V6, 3.0 L	1999-2005
FORD	RANGER	V6, 4.0 L	1995-2005



38006
POLEA DEL TENSOR

CHEVROLET	C4500	GM V8 8.1 L	2003-2008
CHEVROLET	C5500	GM V8 8.1 L	2003-2008
CHEVROLET	C5500	GM V8 8.1 L	2001-2002
CHEVROLET	C6500	GM V8 8.1 L	2001-2008
CHEVROLET	C7500	GM V8 8.1 L	2001-2008

MARCA	MODELO	MOTOR	AÑOS
CHEVROLET	C8500	GM V8 8.1 L	2001-2008
CHEVROLET	S-10	V6, 4.3 L	1994-1995
FORD	E450 SUPER DUTY	FORD V10, 6.8 L	2007-2009
FORD	F-350 SUPER DUTY	V8, 5.4 L	2010-2010
FORD	F-350 SUPER DUTY	V8, 5.4 L	2010-2010
FORD	F-450 SUPER DUTY	V10, 6.8 L	2008-2013
FORD	F-450 SUPER DUTY	V10, 6.8 L	2009-2010
FORD	F-550 SUPER DUTY	V10, 6.8 L	2008-2010
FORD	RANGER	4 CIL., 2.3 L	1995-1995
FORD	RANGER	4 CIL., 2.3 L	1996-2004
FORD	RANGER	4 CIL., 2.5 L	1998-1998
FORD	RANGER	4 CIL., 2.5 L	1999-2001
FORD	RANGER	V6, 3.0 L	1995-2003
FORD	RANGER	V6, 3.0 L	1999-2002
INTERNATIONAL/NAVISTAR	DURASTAR 4300	INTERNATIONAL/NAVISTAR MAXXFORCE 7 DIESEL	2010-2010
 38008 POLEA DEL TENSOR			
CHEVROLET	C4500	GM V8 6.6 L DIESEL	2003-2008
CHEVROLET	C4500	GM V8 8.1 L	2003-2007
CHEVROLET	C5500	GM V8 6.6 L DIESEL	2003-2008
CHEVROLET	C5500	GM V8 8.1 L	2003-2007
CHEVROLET	S-10	V6, 4.3 L	1996-2001
FORD	RANGER	V6, 4.0 L	1995-2004
FORD	RANGER	V6, 4.0 L	1999-2001
 38009 POLEA			
FORD	RANGER	4 CIL., 2.3 L	1996-1997
FORD	RANGER	4 CIL., 2.3 L	1995-1995
 38015 POLEA			
CHEVROLET	S-10	4 CIL., 2.2 L	2003-2003
CHEVROLET	S-10	4 CIL., 2.2 L	1998-2002
 38016 POLEA			
DODGE	RAM-4000	V6, 5.9 L DIESEL	1995-1997
DODGE	RAM-4000	V6, 5.9 L DIESEL	1998-2002

MARCA	MODELO	MOTOR	AÑOS
 38022 POLEA			
FORD	E450 SUPER DUTY	FORD V10, 6.8 L	1999-2001
FORD	E450 SUPER DUTY	FORD V8, 5.4 L	2000-2001
FORD	F-350 SUPER DUTY	V8, 5.4 L	2004-2006
FORD	F-450 SUPER DUTY	FORD V10, 6.8 L	1999-2001
FORD	F-450 SUPER DUTY	V10, 6.8 L	1999-2006
FORD	F-550 SUPER DUTY	FORD V10, 6.8 L	1999-2001
 38023 POLEA DEL TENSOR			
FORD	E450 SUPER DUTY	FORD V10, 6.8 L	1999-2005
FORD	E450 SUPER DUTY	FORD V8, 5.4 L	2000-2001
FORD	E550 SUPER DUTY	FORD V10, 6.8 L	2002-2003
FORD	F-350 SUPER DUTY	V8, 5.4 L	2005-2006
FORD	F-450 SUPER DUTY	FORD V10, 6.8 L	1999-2001
FORD	F-450 SUPER DUTY	V10, 6.8 L	1999-2006
FORD	F-550 SUPER DUTY	FORD V10, 6.8 L	1999-2001
 38024 POLEA			
CHEVROLET	S-10	V6, 4.3 L	1994-1995
 38028 POLEA DEL TENSOR			
FORD	E450 SUPER DUTY	FORD V8, 7.3 L DIESEL	1998-2003
FORD	E550 SUPER DUTY	FORD V8, 7.3 L DIESEL	2002-2003
FORD	F-450 SUPER DUTY	FORD V8, 7.3 L DIESEL	1999-2003
FORD	F-450 SUPER DUTY	V8, 7.3 L	2002-2003
FORD	F-550 SUPER DUTY	FORD V8, 7.3 L DIESEL	1999-2004
FORD	F-650 SUPER DUTY	FORD V8, 7.3 L DIESEL	2000-2004
FORD	F-750 SUPER DUTY	FORD V8, 7.3 L DIESEL	2000-2004
 38033 POLEA DEL TENSOR			
CHEVROLET	C5500	GM V8 8.1 L	2001-2002
CHEVROLET	C6500	GM V8 8.1 L	2001-2008
CHEVROLET	C7500	GM V8 8.1 L	2001-2008
CHEVROLET	C8500	GM V8 8.1 L	2001-2008



MASTER SERVICIO PESADO 2014

TENSORES Y POLEAS

MARCA	MODELO	MOTOR	AÑOS	MARCA	MODELO	MOTOR	AÑOS
 38036 POLEA				FREIGHTLINER	COLUMBIA	DETROIT DIESEL SERIE 60	2001-2001
				FREIGHTLINER	COLUMBIA	DETROIT DIESEL SERIE 60	2005-2006
NISSAN	PICK-UP	4 CIL, 2.4 L	1993-1997	FREIGHTLINER	COLUMBIA	MERCEDES BENZ MBE 4000 Diesel	2008-2010
 38053 POLEA DEL TENSOR				FREIGHTLINER	COLUMBIA	MERCEDES-BENZ MBE 4000 DIESEL	2005-2005
				FREIGHTLINER	COLUMBIA	MERCEDES-BENZ MBE 4000 DIESEL	2005-2007
FREIGHTLINER	COLUMBIA	DETROIT DIESEL 6 CIL, 12.7 L DIESEL	2002-2008	FREIGHTLINER	CORONADO	DETROIT DIESEL 6 CIL, 14.0 L DIESEL	2003-2010
FREIGHTLINER	CORONADO	DETROIT DIESEL 6 CIL, 14.0 L DIESEL	2003-2010	FREIGHTLINER	CORONADO	DETROIT DIESEL SERIE 60	2004-2006
FREIGHTLINER	FLD	DETROIT DIESEL 6 CIL, 11.1 L DIESEL	2000-2002	FREIGHTLINER	FLD	DETROIT DIESEL 6 CIL, 12.7 L DIESEL	2000-2008
FREIGHTLINER	FLD	DETROIT DIESEL 6 CIL, 12.7 L DIESEL	2000-2002	FREIGHTLINER	FLD	DETROIT DIESEL 6 CIL, 14.0 L DIESEL	2001-2010
FREIGHTLINER	FLD	MERCEDES BENZ MBE 4000 Diesel	2009-2010	FREIGHTLINER	FLD	MERCEDES BENZ MBE 4000 Diesel	2009-2010
FREIGHTLINER	FLD120	DETROIT DIESEL SERIE 60	1999-2001	FREIGHTLINER	FLD120	DETROIT DIESEL SERIE 60	1999-2001
FREIGHTLINER	T2000	DETROIT DIESEL 6 CIL, 11.1 L DIESEL	2000-2000	KENWORTH	T2000	DETROIT DIESEL 6 CIL, 11.1 L DIESEL	2000-2000
FREIGHTLINER	T2000	DETROIT DIESEL 6 CIL, 12.7 L DIESEL	2000-2000	KENWORTH	T2000	DETROIT DIESEL 6 CIL, 12.7 L DIESEL	2000-2000
FREIGHTLINER	T800	DETROIT DIESEL 6 CIL, 11.1 L DIESEL	2000-2001	KENWORTH	T800	DETROIT DIESEL 6 CIL, 11.1 L DIESEL	2000-2001
FREIGHTLINER	T800	DETROIT DIESEL 6 CIL, 12.7 L DIESEL	2000-2001	KENWORTH	T800	DETROIT DIESEL 6 CIL, 12.7 L DIESEL	2000-2001
FREIGHTLINER	T800	DETROIT DIESEL SERIE 60	2001-2001	KENWORTH	T800	DETROIT DIESEL SERIE 60	2001-2001
FREIGHTLINER	W900	DETROIT DIESEL 6 CIL, 11.1 L DIESEL	2000-2001	KENWORTH	W900	DETROIT DIESEL 6 CIL, 11.1 L DIESEL	2000-2001
FREIGHTLINER	W900	DETROIT DIESEL 6 CIL, 12.7 L DIESEL	2000-2001	KENWORTH	W900	DETROIT DIESEL 6 CIL, 12.7 L DIESEL	2000-2001
FREIGHTLINER	ARGOSY	DETROIT DIESEL 6 CIL, 11.1 L DIESEL	1999-1999	STERLING	A-LINE	DETROIT DIESEL 6 CIL, 11.1 L DIESEL	2000-2000
FREIGHTLINER	ARGOSY	DETROIT DIESEL 6 CIL, 12.7 L DIESEL	2000-2008	STERLING	A-LINE	DETROIT DIESEL 6 CIL, 11.1 L DIESEL	2001-2001
FREIGHTLINER	ARGOSY	DETROIT DIESEL 6 CIL, 12.7 L DIESEL	1999-1999	STERLING	A-LINE	DETROIT DIESEL 6 CIL, 12.7 L DIESEL	2000-2000
FREIGHTLINER	ARGOSY	DETROIT DIESEL 6 CIL, 14.0 L DIESEL	2001-2008	STERLING	A-LINE	DETROIT DIESEL 6 CIL, 12.7 L DIESEL	2001-2006
FREIGHTLINER	BUSINESS CLASS M2	MERCEDES-BENZ MBE 4000 DIESEL	2004-2007	STERLING	A-LINE	DETROIT DIESEL 6 CIL, 14.0 L DIESEL	2004-2006
FREIGHTLINER	CASCADIA	DETROIT DIESEL 6 CIL, 14.0 L DIESEL	2008-2010	STERLING	A-LINE	DETROIT DIESEL SERIE 60	2001-2001
FREIGHTLINER	CASCADIA	MERCEDES BENZ MBE 4000 Diesel	2008-2012	STERLING	A-LINE	DETROIT DIESEL SERIE 60	2004-2006
FREIGHTLINER	CENTURY CLASS	DETROIT DIESEL 6 CIL, 11.1 L DIESEL	1999-2003	STERLING	A-LINE	MERCEDES-BENZ MBE 4000 DIESEL	2004-2006
FREIGHTLINER	CENTURY CLASS	DETROIT DIESEL 6 CIL, 12.7 L DIESEL	1999-2007	STERLING	L-LINE	DETROIT DIESEL 6 CIL, 11.1 L DIESEL	2000-2001
FREIGHTLINER	CENTURY CLASS	DETROIT DIESEL 6 CIL, 14.0 L DIESEL	2003-2007	STERLING	L-LINE	DETROIT DIESEL 6 CIL, 12.7 L DIESEL	2000-2001
FREIGHTLINER	CENTURY CLASS	DETROIT DIESEL SERIE 60	2002-2005	STERLING	L-LINE	DETROIT DIESEL 6 CIL, 12.7 L DIESEL	2003-2008
FREIGHTLINER	CENTURY CLASS	MERCEDES BENZ MBE 4000 Diesel	2009-2010	STERLING	L-LINE	DETROIT DIESEL 6 CIL, 14.0 L DIESEL	2003-2008
FREIGHTLINER	CENTURY CLASS	MERCEDES-BENZ MBE 4000 DIESEL	2001-2001	STERLING	L-LINE	DETROIT DIESEL SERIE 60	2001-2001
FREIGHTLINER	CENTURY CLASS	MERCEDES-BENZ MBE 4000 DIESEL	2005-2005	STERLING	L-LINE	DETROIT DIESEL SERIE 60	2003-2006
FREIGHTLINER	CLASSIC	DETROIT DIESEL 6 CIL, 11.1 L DIESEL	2001-2002	STERLING	L-LINE	MERCEDES-BENZ MBE 4000 DIESEL	2003-2007
FREIGHTLINER	CLASSIC	DETROIT DIESEL 6 CIL, 12.7 L DIESEL	2001-2007	 38076 POLEA DEL TENSOR			
FREIGHTLINER	CLASSIC	DETROIT DIESEL 6 CIL, 14.0 L DIESEL	2003-2008				
FREIGHTLINER	CLASSIC	DETROIT DIESEL SERIE 60	2005-2005	FREIGHTLINER	ARGOSY	DETROIT DIESEL 6 CIL, 11.1 L DIESEL	2000-2003
FREIGHTLINER	CLASSIC	MERCEDES BENZ MBE 4000 Diesel	2009-2010	FREIGHTLINER	ARGOSY	DETROIT DIESEL 6 CIL, 12.7 L DIESEL	2000-2008
FREIGHTLINER	CLASSIC XL	DETROIT DIESEL 6 CIL, 11.1 L DIESEL	2001-2002	FREIGHTLINER	ARGOSY	DETROIT DIESEL 6 CIL, 14.0 L DIESEL	2001-2008
FREIGHTLINER	CLASSIC XL	DETROIT DIESEL 6 CIL, 12.7 L DIESEL	2001-2007	FREIGHTLINER	CASCADIA	DETROIT DIESEL 6 CIL, 14.0 L DIESEL	2008-2010
FREIGHTLINER	CLASSIC XL	DETROIT DIESEL 6 CIL, 14.0 L DIESEL	2001-2008	FREIGHTLINER	CENTURY CLASS	DETROIT DIESEL 6 CIL, 12.7 L DIESEL	2004-2007
FREIGHTLINER	CLASSIC XL	MERCEDES BENZ MBE 4000 Diesel	2009-2010	FREIGHTLINER	CENTURY CLASS	DETROIT DIESEL 6 CIL, 14.0 L DIESEL	2004-2007
FREIGHTLINER	COLUMBIA	DETROIT DIESEL 6 CIL, 11.1 L DIESEL	2000-2001	FREIGHTLINER	CENTURY CLASS	DETROIT DIESEL SERIE 60	2005-2005
FREIGHTLINER	COLUMBIA	DETROIT DIESEL 6 CIL, 12.7 L DIESEL	2000-2009				
FREIGHTLINER	COLUMBIA	DETROIT DIESEL 6 CIL, 14.0 L DIESEL	2002-2011				



MASTER SERVICIO PESADO 2014

TENSORES Y POLEAS

MARCA	MODELO	MOTOR	AÑOS
FREIGHTLINER	CLASSIC	DETROIT DIESEL 6 CIL, 12.7 L DIESEL	2005-2007
FREIGHTLINER	CLASSIC	DETROIT DIESEL 6 CIL, 14.0 L DIESEL	2005-2008
FREIGHTLINER	CLASSIC	DETROIT DIESEL SERIE 60	2005-2005
FREIGHTLINER	CLASSIC XL	DETROIT DIESEL 6 CIL, 12.7 L DIESEL	2005-2007
FREIGHTLINER	CLASSIC XL	DETROIT DIESEL 6 CIL, 14.0 L DIESEL	2005-2008
FREIGHTLINER	COLUMBIA	DETROIT DIESEL 6 CIL, 12.7 L DIESEL	2004-2009
FREIGHTLINER	COLUMBIA	DETROIT DIESEL 6 CIL, 14.0 L DIESEL	2004-2011
FREIGHTLINER	COLUMBIA	DETROIT DIESEL SERIE 60	2005-2006
FREIGHTLINER	CORONADO	DETROIT DIESEL 6 CIL, 12.7 L DIESEL	2002-2008
FREIGHTLINER	CORONADO	DETROIT DIESEL 6 CIL, 14.0 L DIESEL	2003-2010
FREIGHTLINER	CORONADO	DETROIT DIESEL SERIE 60	2005-2006
FREIGHTLINER	FLD	DETROIT DIESEL 6 CIL, 12.7 L DIESEL	2005-2008
FREIGHTLINER	FLD	DETROIT DIESEL 6 CIL, 14.0 L DIESEL	2005-2010
STERLING	A-LINE	DETROIT DIESEL 6 CIL, 12.7 L DIESEL	2004-2006
STERLING	A-LINE	DETROIT DIESEL 6 CIL, 14.0 L DIESEL	2004-2006
STERLING	A-LINE	DETROIT DIESEL SERIE 60	2004-2006
STERLING	L-LINE	DETROIT DIESEL 6 CIL, 12.7 L DIESEL	2004-2008
STERLING	L-LINE	DETROIT DIESEL 6 CIL, 14.0 L DIESEL	2004-2008
STERLING	L-LINE	DETROIT DIESEL SERIE 60	2004-2006
VOLVO	VNL 64T	DETROIT DIESEL SERIE 60	1999-2000



38092
POLEA DEL TENSOR

FREIGHTLINER	CENTURY CLASS	CATERPILLAR C10 DIESEL	1999-2000
FREIGHTLINER	CENTURY CLASS	CATERPILLAR C12 DIESEL	1999-2000
FREIGHTLINER	FL112	CATERPILLAR C10 DIESEL	1999-2000
FREIGHTLINER	FL112	CATERPILLAR C12 DIESEL	1999-2000
FREIGHTLINER	FLD	CATERPILLAR C10 DIESEL	1998-2000
FREIGHTLINER	FLD	CATERPILLAR C12 DIESEL	1998-2000

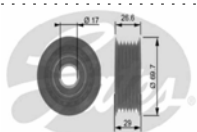

38099
POLEA

MERCEDES BENZ	SPRINTER	4 CIL, 2.2 L CDI	2006-2013
MERCEDES BENZ	SPRINTER	5 CIL, 2.7 L CDI	2003-2006
MERCEDES BENZ	VITO	4 CIL, 2.2 L CDI	2009-2013



38102
TENSOR

FORD	RANGER	V6, 4.0 L	1995-2000
------	--------	-----------	-----------



38103
TENSOR

CHEVROLET	S-10	V6, 4.3 L	2002-2002
-----------	------	-----------	-----------

MARCA	MODELO	MOTOR	AÑOS
CHEVROLET	S-10	V6, 4.3 L	1996-2001



38108
TENSOR

CHEVROLET	S-10	V6, 4.3 L	1995-1995
-----------	------	-----------	-----------

CHEVROLET	S-10	V6, 4.3 L	1992-1994
-----------	------	-----------	-----------



38114
TENSOR

FORD	RANGER	V6, 3.0 L	1995-2002
------	--------	-----------	-----------



38116
TENSOR

DODGE	RAM-4000	V6, 5.9 L DIESEL	1995-2002
-------	----------	------------------	-----------



38133
TENSOR

FORD	E450 SUPER DUTY	FORD V10, 6.8 L	1999-2005
------	-----------------	-----------------	-----------

FORD	E450 SUPER DUTY	FORD V8, 5.4 L	2000-2001
------	-----------------	----------------	-----------

FORD	E550 SUPER DUTY	FORD V10, 6.8 L	2002-2003
------	-----------------	-----------------	-----------

FORD	F-350 SUPER DUTY	V8, 5.4 L	2004-2006
------	------------------	-----------	-----------

FORD	F-450 SUPER DUTY	FORD V10, 6.8 L	1999-2001
------	------------------	-----------------	-----------

FORD	F-450 SUPER DUTY	V10, 6.8 L	1999-2006
------	------------------	------------	-----------

FORD	F-550 SUPER DUTY	FORD V10, 6.8 L	1999-2001
------	------------------	-----------------	-----------



38137
TENSOR

FORD	RANGER	V6, 4.0 L	2001-2005
------	--------	-----------	-----------



38140
TENSOR PARA BANDA MICRO-V

FORD	F-450 SUPER DUTY	V8, 7.5 L	1997-1997
------	------------------	-----------	-----------



38155
TENSOR

FORD	RANGER	4 CIL, 2.3 L	1995-2012
------	--------	--------------	-----------

FORD	RANGER	4 CIL, 2.5 L	1998-2001
------	--------	--------------	-----------



38165
TENSOR

MARCA	MODELO	MOTOR	AÑOS
CHEVROLET	S-10	4 CIL., 2.2 L	1998-2002
 38172 TENSOR			
CHEVROLET	C4500	GM V8 6.6 L DIESEL	2003-2008
CHEVROLET	C5500	GM V8 6.6 L DIESEL	2003-2008
 38187 TENSOR			
CHEVROLET	S-10	4 CIL., 2.2 L	1994-1997
 38191 TENSOR			
FORD	F-450 SUPER DUTY	FORD V8, 7.3 L DIESEL	1999-2003
FORD	F-450 SUPER DUTY	V8, 7.3 L	2002-2003
FORD	F-550 SUPER DUTY	FORD V8, 7.3 L DIESEL	1999-2004
FORD	F-650 SUPER DUTY	FORD V8, 7.3 L DIESEL	2000-2004
FORD	F-750 SUPER DUTY	FORD V8, 7.3 L DIESEL	2000-2004
 38256 TENSOR			
CHEVROLET	C5500	GM V8 8.1 L	2001-2002
CHEVROLET	C6500	GM V8 8.1 L	2001-2008
CHEVROLET	C7500	GM V8 8.1 L	2001-2008
CHEVROLET	C8500	GM V8 8.1 L	2001-2008
CHEVROLET	KODIAK	GM V8, 8.1 L	2001-2008
 38257 TENSOR			
FORD	E450 SUPER DUTY	FORD V8, 6.0 L DIESEL	2003-2006
FORD	F-450 SUPER DUTY	FORD V8, 6.0 L DIESEL	2003-2007
FORD	F-550 SUPER DUTY	FORD V8, 6.0 L DIESEL	2003-2007
INTERNATIONAL/NAVISTAR	CF500	INTERNATIONAL/NAVISTAR VT275 DIESEL	2005-2008
INTERNATIONAL/NAVISTAR	CF600	INTERNATIONAL/NAVISTAR VT275 DIESEL	2005-2008
 38258 TENSOR			
CHEVROLET	C4500	GM V8 8.1 L	2008-2008
CHEVROLET	C4500	GM V8 8.1 L	2003-2007
CHEVROLET	C5500	GM V8 8.1 L	2008-2008
CHEVROLET	C5500	GM V8 8.1 L	2003-2007

MARCA	MODELO	MOTOR	AÑOS
 38261 TENSOR			
CHEVROLET	C5500	GM V8 8.1 L	2001-2002
CHEVROLET	C6500	GM V8 8.1 L	2001-2002
CHEVROLET	C7500	GM V8 8.1 L	2001-2002
CHEVROLET	C8500	GM V8 8.1 L	2001-2002
CHEVROLET	KODIAK	GM V8, 8.1 L	2001-2008
 38274 TENSOR			
FORD	E450 SUPER DUTY	FORD V10, 6.8 L	2006-2009
FORD	E450 SUPER DUTY	FORD V8, 5.4 L	2002-2004
FORD	F-350 SUPER DUTY	V8, 5.4 L	2004-2010
FORD	F-350 SUPER DUTY	V8, 5.4 L	2010-2010
FORD	F-450 SUPER DUTY	FORD V10, 6.8 L	2002-2006
FORD	F-450 SUPER DUTY	V10, 6.8 L	2008-2008
FORD	F-450 SUPER DUTY	V10, 6.8 L	2009-2013
FORD	F-450 SUPER DUTY	V10, 6.8 L	2007-2007
FORD	F-450 SUPER DUTY	V10, 6.8 L	2009-2010
FORD	F-550 SUPER DUTY	FORD V10, 6.8 L	2002-2006
FORD	F-550 SUPER DUTY	V10, 6.8 L	2008-2010
 38285 TENSOR			
DODGE	RAM-4000	V6, 5.9 L DIESEL	2003-2008
DODGE	RAM-4000	V6, 6.7 L DIESEL	2008-2013
 38324 TENSOR			
CHEVROLET	C6500	GM V8 8.1 L	2003-2008
CHEVROLET	C7500	GM V8 8.1 L	2003-2008
CHEVROLET	C8500	GM V8 8.1 L	2003-2008
 38329 TENSOR			
FORD	E450 SUPER DUTY	FORD V10, 6.8 L	2006-2009
FORD	E450 SUPER DUTY	FORD V8, 5.4 L	2005-2005
FORD	F-350 SUPER DUTY	V8, 5.4 L	2007-2010
FORD	F-350 SUPER DUTY	V8, 5.4 L	2010-2010
FORD	F-450 SUPER DUTY	FORD V10, 6.8 L	2002-2006
FORD	F-450 SUPER DUTY	V10, 6.8 L	2009-2013

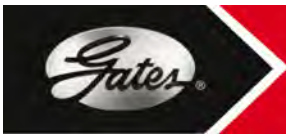

MASTER SERVICIO PESADO 2014

TENSORES Y POLEAS

MARCA	MODELO	MOTOR	AÑOS
FORD	F-450 SUPER DUTY	V10, 6.8 L	2008-2008
FORD	F-450 SUPER DUTY	V10, 6.8 L	2007-2007
FORD	F-450 SUPER DUTY	V10, 6.8 L	2009-2010
FORD	F-550 SUPER DUTY	FORD V10, 6.8 L	2002-2006
FORD	F-550 SUPER DUTY	V10, 6.8 L	2008-2010
 38330 TENSOR			
FORD	E450 SUPER DUTY	FORD V10, 6.8 L	1999-2005
FORD	E550 SUPER DUTY	FORD V10, 6.8 L	2002-2003
FORD	F-350 SUPER DUTY	V8, 5.4 L	2004-2006
FORD	F-450 SUPER DUTY	FORD V10, 6.8 L	1999-2001
FORD	F-550 SUPER DUTY	FORD V10, 6.8 L	1999-2001
 38378 TENSOR			
NISSAN	NV2500	V6, 4.0 L	2013-2014
 38427 TENSOR			
VOLKSWAGEN	TRANSPORTER	4 CIL. 2.0 L TDI	2010-2014
 38501 TENSOR			
FREIGHTLINER	ARGOSY	DETROIT DIESEL 6 CIL, 11.1 L DIESEL	2000-2003
FREIGHTLINER	ARGOSY	DETROIT DIESEL 6 CIL, 11.1 L DIESEL	1999-1999
FREIGHTLINER	ARGOSY	DETROIT DIESEL 6 CIL, 12.7 L DIESEL	2000-2008
FREIGHTLINER	ARGOSY	DETROIT DIESEL 6 CIL, 12.7 L DIESEL	1999-1999
FREIGHTLINER	ARGOSY	DETROIT DIESEL 6 CIL, 14.0 L DIESEL	2001-2008
FREIGHTLINER	BUSINESS CLASS M2	MERCEDES-BENZ MBE 4000 DIESEL	2004-2007
FREIGHTLINER	CASCADIA	DETROIT DIESEL 6 CIL, 14.0 L DIESEL	2008-2010
FREIGHTLINER	CASCADIA	MERCEDES BENZ MBE 4000 Diesel	2008-2012
FREIGHTLINER	CENTURY CLASS	DETROIT DIESEL 6 CIL, 11.1 L DIESEL	1999-2003
FREIGHTLINER	CENTURY CLASS	DETROIT DIESEL 6 CIL, 12.7 L DIESEL	1999-2007
FREIGHTLINER	CENTURY CLASS	DETROIT DIESEL 6 CIL, 14.0 L DIESEL	2003-2007
FREIGHTLINER	CENTURY CLASS	DETROIT DIESEL SERIE 60	2002-2005
FREIGHTLINER	CENTURY CLASS	MERCEDES BENZ MBE 4000 Diesel	2009-2010
FREIGHTLINER	CENTURY CLASS	MERCEDES-BENZ MBE 4000 DIESEL	2001-2001
FREIGHTLINER	CENTURY CLASS	MERCEDES-BENZ MBE 4000 DIESEL	2005-2005
FREIGHTLINER	CLASSIC	DETROIT DIESEL 6 CIL, 11.1 L DIESEL	2001-2002
FREIGHTLINER	CLASSIC	DETROIT DIESEL 6 CIL, 12.7 L DIESEL	2001-2007
FREIGHTLINER	CLASSIC	DETROIT DIESEL 6 CIL, 14.0 L DIESEL	2003-2008
FREIGHTLINER	CLASSIC	DETROIT DIESEL SERIE 60	2005-2005



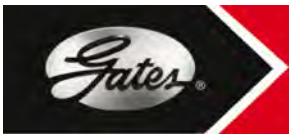

MARCA	MODELO	MOTOR	AÑOS
FREIGHTLINER	CLASSIC	MERCEDES BENZ MBE 4000 Diesel	2009-2010
FREIGHTLINER	CLASSIC XL	DETROIT DIESEL 6 CIL, 11.1 L DIESEL	2001-2002
FREIGHTLINER	CLASSIC XL	DETROIT DIESEL 6 CIL, 12.7 L DIESEL	2001-2007
FREIGHTLINER	CLASSIC XL	DETROIT DIESEL 6 CIL, 14.0 L DIESEL	2001-2008
FREIGHTLINER	CLASSIC XL	MERCEDES BENZ MBE 4000 Diesel	2009-2010
FREIGHTLINER	COLUMBIA	DETROIT DIESEL 6 CIL, 11.1 L DIESEL	2000-2001
FREIGHTLINER	COLUMBIA	DETROIT DIESEL 6 CIL, 12.7 L DIESEL	2000-2009
FREIGHTLINER	COLUMBIA	DETROIT DIESEL 6 CIL, 14.0 L DIESEL	2002-2011
FREIGHTLINER	COLUMBIA	DETROIT DIESEL SERIE 60	2001-2001
FREIGHTLINER	COLUMBIA	DETROIT DIESEL SERIE 60	2004-2006
FREIGHTLINER	COLUMBIA	DETROIT DIESEL SERIE 60	2003-2003
FREIGHTLINER	COLUMBIA	MERCEDES BENZ MBE 4000 Diesel	2008-2010
FREIGHTLINER	COLUMBIA	MERCEDES-BENZ MBE 4000 DIESEL	2005-2007
FREIGHTLINER	CORONADO	DETROIT DIESEL 6 CIL, 12.7 L DIESEL	2002-2008
FREIGHTLINER	CORONADO	DETROIT DIESEL 6 CIL, 14.0 L DIESEL	2003-2010
FREIGHTLINER	CORONADO	DETROIT DIESEL SERIE 60	2004-2006
FREIGHTLINER	FLD	DETROIT DIESEL 6 CIL, 11.1 L DIESEL	2000-2002
FREIGHTLINER	FLD	DETROIT DIESEL 6 CIL, 12.7 L DIESEL	2000-2008
FREIGHTLINER	FLD	DETROIT DIESEL 6 CIL, 14.0 L DIESEL	2001-2010
FREIGHTLINER	FLD	DETROIT DIESEL SERIE 60	2002-2006
FREIGHTLINER	FLD	MERCEDES BENZ MBE 4000 Diesel	2009-2010
FREIGHTLINER	FLD120	DETROIT DIESEL SERIE 60	1999-2001
KENWORTH	T2000	DETROIT DIESEL 6 CIL, 11.1 L DIESEL	2000-2000
KENWORTH	T2000	DETROIT DIESEL 6 CIL, 12.7 L DIESEL	2000-2000
KENWORTH	T800	DETROIT DIESEL 6 CIL, 11.1 L DIESEL	2000-2001
KENWORTH	T800	DETROIT DIESEL 6 CIL, 12.7 L DIESEL	2000-2001
KENWORTH	T800	DETROIT DIESEL SERIE 60	2001-2001
KENWORTH	W900	DETROIT DIESEL 6 CIL, 11.1 L DIESEL	2000-2001
KENWORTH	W900	DETROIT DIESEL 6 CIL, 12.7 L DIESEL	2000-2001
STERLING	A-LINE	DETROIT DIESEL 6 CIL, 11.1 L DIESEL	2001-2002
STERLING	A-LINE	DETROIT DIESEL 6 CIL, 12.7 L DIESEL	2001-2006
STERLING	A-LINE	DETROIT DIESEL 6 CIL, 14.0 L DIESEL	2004-2006
STERLING	A-LINE	DETROIT DIESEL SERIE 60	2002-2006
STERLING	A-LINE	MERCEDES-BENZ MBE 4000 DIESEL	2008-2008
STERLING	A-LINE	MERCEDES-BENZ MBE 4000 DIESEL	2004-2006
STERLING	L-LINE	DETROIT DIESEL 6 CIL, 11.1 L DIESEL	2002-2002
STERLING	L-LINE	DETROIT DIESEL 6 CIL, 12.7 L DIESEL	2002-2008
STERLING	L-LINE	DETROIT DIESEL 6 CIL, 14.0 L DIESEL	2004-2008
STERLING	L-LINE	DETROIT DIESEL SERIE 60	2002-2006
STERLING	L-LINE	MERCEDES-BENZ MBE 4000 DIESEL	2003-2007
 38502 TENSOR			
STERLING	A-LINE	DETROIT DIESEL 6 CIL, 11.1 L DIESEL	2000-2000
STERLING	A-LINE	DETROIT DIESEL 6 CIL, 12.7 L DIESEL	2000-2000

MARCA	MODELO	MOTOR	AÑOS	MARCA	MODELO	MOTOR	AÑOS
STERLING	A-LINE	DETROIT DIESEL SERIE 60	2001-2001	FREIGHTLINER	COLUMBIA	CUMMINS ISM DIESEL	2001-2003
STERLING	L-LINE	DETROIT DIESEL 6 CIL, 11.1 L DIESEL	2000-2001	FREIGHTLINER	FL112	CUMMINS ISM DIESEL	1999-2003
STERLING	L-LINE	DETROIT DIESEL 6 CIL, 12.7 L DIESEL	2000-2001	FREIGHTLINER	FL112	DETROIT DIESEL SERIE 50	1999-1999
STERLING	L-LINE	DETROIT DIESEL 6 CIL, 12.7 L DIESEL	2003-2003	FREIGHTLINER	FLD	CUMMINS ISM DIESEL	1999-2003
STERLING	L-LINE	DETROIT DIESEL 6 CIL, 14.0 L DIESEL	2003-2003	FREIGHTLINER	FLD120	CUMMINS ISM DIESEL	2001-2002
STERLING	L-LINE	DETROIT DIESEL SERIE 60	2001-2001	INTERNATIONAL/NAVISTAR	5500	CUMMINS ISM DIESEL	2005-2005
STERLING	L-LINE	DETROIT DIESEL SERIE 60	2003-2003	INTERNATIONAL/NAVISTAR	5500I	CUMMINS ISM DIESEL	2002-2006
 <div style="background-color: red; color: white; padding: 5px; text-align: center; font-weight: bold;">38503 TENSOR</div>				INTERNATIONAL/NAVISTAR	5600	CUMMINS ISM DIESEL	2005-2005
				INTERNATIONAL/NAVISTAR	5600I	CUMMINS ISM DIESEL	2002-2007
FREIGHTLINER	ARGOSY	DETROIT DIESEL 6 CIL, 11.1 L DIESEL	2000-2003	INTERNATIONAL/NAVISTAR	5900I	CUMMINS ISM DIESEL	2001-2006
FREIGHTLINER	ARGOSY	DETROIT DIESEL 6 CIL, 12.7 L DIESEL	2000-2008	INTERNATIONAL/NAVISTAR	7400	CUMMINS ISM DIESEL	2005-2005
FREIGHTLINER	ARGOSY	DETROIT DIESEL 6 CIL, 14.0 L DIESEL	2001-2008	INTERNATIONAL/NAVISTAR	7600	CUMMINS ISM DIESEL	2003-2007
FREIGHTLINER	CASCADIA	DETROIT DIESEL 6 CIL, 14.0 L DIESEL	2008-2010	INTERNATIONAL/NAVISTAR	7700	CUMMINS ISM DIESEL	2005-2006
FREIGHTLINER	CENTURY CLASS	DETROIT DIESEL 6 CIL, 12.7 L DIESEL	2004-2007	INTERNATIONAL/NAVISTAR	8600	CUMMINS ISM DIESEL	2003-2007
FREIGHTLINER	CENTURY CLASS	DETROIT DIESEL 6 CIL, 14.0 L DIESEL	2004-2007	INTERNATIONAL/NAVISTAR	9200	CUMMINS ISM DIESEL	2005-2005
FREIGHTLINER	CENTURY CLASS	DETROIT DIESEL SERIE 60	2005-2005	INTERNATIONAL/NAVISTAR	9200I	CUMMINS ISM DIESEL	2003-2007
FREIGHTLINER	CLASSIC	DETROIT DIESEL 6 CIL, 12.7 L DIESEL	2005-2007	INTERNATIONAL/NAVISTAR	9400I	CUMMINS ISM DIESEL	2004-2007
FREIGHTLINER	CLASSIC	DETROIT DIESEL 6 CIL, 14.0 L DIESEL	2005-2008	INTERNATIONAL/NAVISTAR	TRANSTAR 8600	CUMMINS ISM DIESEL	2008-2008
FREIGHTLINER	CLASSIC	DETROIT DIESEL SERIE 60	2005-2005	INTERNATIONAL/NAVISTAR	WORKSTAR 7600	CUMMINS ISM DIESEL	2008-2010
FREIGHTLINER	CLASSIC XL	DETROIT DIESEL 6 CIL, 12.7 L DIESEL	2005-2007	INTERNATIONAL/NAVISTAR	WORKSTAR 7600	CUMMINS ISM DIESEL	2008-2008
FREIGHTLINER	CLASSIC XL	DETROIT DIESEL 6 CIL, 14.0 L DIESEL	2005-2008	KENWORTH	T2000	CATERPILLAR C10 DIESEL	1997-1999
FREIGHTLINER	COLUMBIA	DETROIT DIESEL 6 CIL, 12.7 L DIESEL	2004-2009	KENWORTH	T2000	CATERPILLAR C12 DIESEL	1998-1999
FREIGHTLINER	COLUMBIA	DETROIT DIESEL 6 CIL, 14.0 L DIESEL	2004-2011	KENWORTH	T600	CUMMINS ISM DIESEL	2004-2004
FREIGHTLINER	COLUMBIA	DETROIT DIESEL SERIE 60	2004-2006	KENWORTH	T800	CUMMINS ISM DIESEL	2008-2014
FREIGHTLINER	CORONADO	DETROIT DIESEL 6 CIL, 12.7 L DIESEL	2002-2008	KENWORTH	T800	CUMMINS ISM DIESEL	2003-2007
FREIGHTLINER	CORONADO	DETROIT DIESEL 6 CIL, 14.0 L DIESEL	2003-2010	KENWORTH	W900	CUMMINS ISM DIESEL	2003-2006
FREIGHTLINER	CORONADO	DETROIT DIESEL SERIE 60	2004-2006	VOLVO	AUTOCAR	DETROIT DIESEL 6 CIL, 11.1 L DIESEL	1998-1998
FREIGHTLINER	FLD	DETROIT DIESEL 6 CIL, 12.7 L DIESEL	2005-2008	VOLVO	AUTOCAR	DETROIT DIESEL 6 CIL, 12.7 L DIESEL	1998-1998
FREIGHTLINER	FLD	DETROIT DIESEL 6 CIL, 14.0 L DIESEL	2005-2010	VOLVO	VNL	CATERPILLAR 3406 DIESEL	1999-1999
FREIGHTLINER	FLD	DETROIT DIESEL SERIE 60	2006-2006	VOLVO	VNL	DETROIT DIESEL 6 CIL, 11.1 L DIESEL	1998-2001
STERLING	A-LINE	DETROIT DIESEL 6 CIL, 12.7 L DIESEL	2004-2006	VOLVO	VNL	DETROIT DIESEL 6 CIL, 12.7 L DIESEL	1998-2001
STERLING	A-LINE	DETROIT DIESEL 6 CIL, 14.0 L DIESEL	2004-2006	VOLVO	VNL 64T	DETROIT DIESEL SERIE 60	1999-2000
STERLING	A-LINE	DETROIT DIESEL SERIE 60	2004-2006	 <div style="background-color: red; color: white; padding: 5px; text-align: center; font-weight: bold;">38506 TENSOR</div>			
STERLING	L-LINE	DETROIT DIESEL 6 CIL, 12.7 L DIESEL	2004-2008				
STERLING	L-LINE	DETROIT DIESEL 6 CIL, 14.0 L DIESEL	2004-2008	FORD	F-650 SUPER DUTY	CATERPILLAR 3126 DIESEL	2000-2004
STERLING	L-LINE	DETROIT DIESEL SERIE 60	2004-2006	FORD	F-750 SUPER DUTY	CATERPILLAR 3126 DIESEL	2000-2004
 <div style="background-color: red; color: white; padding: 5px; text-align: center; font-weight: bold;">38505 TENSOR</div>				FREIGHTLINER	ARGOSY	CATERPILLAR C10 DIESEL	2000-2003
				FREIGHTLINER	ARGOSY	CATERPILLAR C12 DIESEL	2000-2004
FREIGHTLINER	ARGOSY	CATERPILLAR C15 DIESEL	2001-2004	FREIGHTLINER	ARGOSY	CATERPILLAR C12 DIESEL	2000-2004
FREIGHTLINER	CENTURY CLASS	CATERPILLAR 3406 DIESEL	1998-1999	FREIGHTLINER	ARGOSY	CATERPILLAR C10 DIESEL	2000-2003
FREIGHTLINER	CENTURY CLASS	CUMMINS ISM DIESEL	1999-2001	FREIGHTLINER	CENTURY CLASS	CATERPILLAR C10 DIESEL	1998-2003
FREIGHTLINER	CLASSIC	CUMMINS ISM DIESEL	2001-2003	FREIGHTLINER	CENTURY CLASS	CATERPILLAR C10 DIESEL	2000-2000
FREIGHTLINER	CLASSIC XL	CUMMINS ISM DIESEL	2001-2003	FREIGHTLINER	CENTURY CLASS	CATERPILLAR C12 DIESEL	1999-2004
				FREIGHTLINER	CENTURY CLASS	CATERPILLAR C12 DIESEL	2000-2000



MASTER SERVICIO PESADO 2014

TENSORES Y POLEAS

MARCA	MODELO	MOTOR	AÑOS	MARCA	MODELO	MOTOR	AÑOS
FREIGHTLINER	CENTURY CLASS	CATERPILLAR C15 DIESEL	2001-2004	KENWORTH	T800	CATERPILLAR C10 DIESEL	1997-2004
FREIGHTLINER	CENTURY CLASS	DETROIT DIESEL SERIE 60	2003-2003	KENWORTH	T800	CATERPILLAR C12 DIESEL	1996-2004
FREIGHTLINER	CLASSIC	CATERPILLAR C15 DIESEL	2001-2006	KENWORTH	T800	CATERPILLAR C15 DIESEL	2004-2004
FREIGHTLINER	CLASSIC	CATERPILLAR C16 DIESEL	2001-2003	STERLING	A-LINE	CATERPILLAR C10 DIESEL	2002-2004
FREIGHTLINER	CLASSIC XL	CATERPILLAR C15 DIESEL	2001-2006	STERLING	A-LINE	CATERPILLAR C12 DIESEL	2002-2004
FREIGHTLINER	CLASSIC XL	CATERPILLAR C16 DIESEL	2001-2003				
FREIGHTLINER	COLUMBIA	CATERPILLAR C10 DIESEL	2001-2003				
FREIGHTLINER	COLUMBIA	CATERPILLAR C12 DIESEL	2003-2004				
FREIGHTLINER	COLUMBIA	CATERPILLAR C15 DIESEL	2001-2003				
FREIGHTLINER	COLUMBIA	CATERPILLAR C16 DIESEL	2001-2004	FREIGHTLINER	CENTURY CLASS	CUMMINS ISM DIESEL	1998-1998
FREIGHTLINER	CORONADO	CATERPILLAR C15 DIESEL	2002-2004	INTERNATIONAL/NAVISTAR	7600	CATERPILLAR C10 DIESEL	2002-2003
FREIGHTLINER	CORONADO	CATERPILLAR C16 DIESEL	2002-2003	INTERNATIONAL/NAVISTAR	7600	CATERPILLAR C12 DIESEL	2002-2003
FREIGHTLINER	FL112	CATERPILLAR C10 DIESEL	1999-1999	INTERNATIONAL/NAVISTAR	8100	CATERPILLAR C10 DIESEL	2002-2003
FREIGHTLINER	FL112	CATERPILLAR C10 DIESEL	2000-2004	INTERNATIONAL/NAVISTAR	8600	CATERPILLAR C10 DIESEL	2003-2004
FREIGHTLINER	FL112	CATERPILLAR C12 DIESEL	1999-1999	INTERNATIONAL/NAVISTAR	8600	CATERPILLAR C12 DIESEL	2003-2004
FREIGHTLINER	FL112	CATERPILLAR C12 DIESEL	2000-2004	INTERNATIONAL/NAVISTAR	9200I	CATERPILLAR C10 DIESEL	2004-2004
FREIGHTLINER	FLD	CATERPILLAR 3406 DIESEL	1998-2000	INTERNATIONAL/NAVISTAR	9200I	CATERPILLAR C12 DIESEL	2004-2004
FREIGHTLINER	FLD	CATERPILLAR 3406 E DIESEL	1999-2000				
FREIGHTLINER	FLD	CATERPILLAR C10 DIESEL	1998-2004				
FREIGHTLINER	FLD	CATERPILLAR C10 DIESEL	2000-2000	FREIGHTLINER	ARGOSY	CATERPILLAR C15 DIESEL	2001-2004
FREIGHTLINER	FLD	CATERPILLAR C12 DIESEL	1998-2004	FREIGHTLINER	CENTURY CLASS	CATERPILLAR 3406 DIESEL	1998-1999
FREIGHTLINER	FLD	CATERPILLAR C15 DIESEL	2000-2004	FREIGHTLINER	CENTURY CLASS	CATERPILLAR C15 DIESEL	2001-2004
FREIGHTLINER	FLD	CATERPILLAR C16 DIESEL	2000-2004	FREIGHTLINER	CLASSIC	CATERPILLAR C15 DIESEL	2001-2006
FREIGHTLINER	FLD120	CATERPILLAR C10 DIESEL	2001-2004	FREIGHTLINER	CLASSIC	CATERPILLAR C16 DIESEL	2001-2003
FREIGHTLINER	FLD120	CATERPILLAR C12 DIESEL	2001-2004	FREIGHTLINER	CLASSIC XL	CATERPILLAR C15 DIESEL	2001-2006
INTERNATIONAL/NAVISTAR	5000	CATERPILLAR C12 DIESEL	1998-1999	FREIGHTLINER	CLASSIC XL	CATERPILLAR C16 DIESEL	2001-2003
INTERNATIONAL/NAVISTAR	5500I	CATERPILLAR C10 DIESEL	2003-2004	FREIGHTLINER	COLUMBIA	CATERPILLAR C15 DIESEL	2001-2003
INTERNATIONAL/NAVISTAR	5500I	CATERPILLAR C12 DIESEL	2003-2004	FREIGHTLINER	COLUMBIA	CATERPILLAR C16 DIESEL	2001-2004
INTERNATIONAL/NAVISTAR	5600I	CATERPILLAR C10 DIESEL	2002-2004	FREIGHTLINER	CORONADO	CATERPILLAR C15 DIESEL	2002-2004
INTERNATIONAL/NAVISTAR	5600I	CATERPILLAR C12 DIESEL	2003-2004	FREIGHTLINER	CORONADO	CATERPILLAR C16 DIESEL	2002-2003
INTERNATIONAL/NAVISTAR	5900I	CATERPILLAR C10 DIESEL	2000-2003	FREIGHTLINER	FLD	CATERPILLAR 3406 DIESEL	1998-2000
INTERNATIONAL/NAVISTAR	5900I	CATERPILLAR C12 DIESEL	2002-2004	FREIGHTLINER	FLD	CATERPILLAR 3406 E DIESEL	1999-2000
INTERNATIONAL/NAVISTAR	7600	CATERPILLAR C10 DIESEL	2002-2004	FREIGHTLINER	FLD	CATERPILLAR C15 DIESEL	2000-2004
INTERNATIONAL/NAVISTAR	7600	CATERPILLAR C12 DIESEL	2002-2004	FREIGHTLINER	FLD	CATERPILLAR C16 DIESEL	2000-2004
INTERNATIONAL/NAVISTAR	8100	CATERPILLAR C10 DIESEL	2002-2003	KENWORTH	T600	CATERPILLAR C15 DIESEL	2000-2006
INTERNATIONAL/NAVISTAR	8600	CATERPILLAR C10 DIESEL	2003-2004	KENWORTH	T800	CATERPILLAR C15 DIESEL	2004-2004
INTERNATIONAL/NAVISTAR	8600	CATERPILLAR C12 DIESEL	2003-2004				
INTERNATIONAL/NAVISTAR	9200	CATERPILLAR 3176 DIESEL	1995-1995				
INTERNATIONAL/NAVISTAR	9200I	CATERPILLAR C10 DIESEL	2004-2004	CHEVROLET	C5500	CATERPILLAR 3116 DIESEL	1999-1999
INTERNATIONAL/NAVISTAR	9200I	CATERPILLAR C12 DIESEL	2004-2004	CHEVROLET	C5500	CATERPILLAR 3126 DIESEL	1998-2002
INTERNATIONAL/NAVISTAR	9300	CATERPILLAR 3176 DIESEL	1995-1995	CHEVROLET	C6500	CATERPILLAR 3116 DIESEL	1997-2000
INTERNATIONAL/NAVISTAR	9400	CATERPILLAR 3176 DIESEL	1995-1997	CHEVROLET	C6500	CATERPILLAR 3126 DIESEL	1998-2002
KENWORTH	T600	CATERPILLAR C10 DIESEL	1997-2004	CHEVROLET	C7500	CATERPILLAR 3116 DIESEL	1997-2000
KENWORTH	T600	CATERPILLAR C12 DIESEL	1996-2004				
KENWORTH	T600	CATERPILLAR C15 DIESEL	2000-2006				

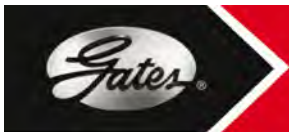

MASTER SERVICIO PESADO 2014

TENSORES Y POLEAS

MARCA	MODELO	MOTOR	AÑOS
CHEVROLET	C7500	CATERPILLAR 3126 DIESEL	1998-2002
CHEVROLET	C8500	CATERPILLAR 3116 DIESEL	1997-2000
CHEVROLET	C8500	CATERPILLAR 3126 DIESEL	1998-2002
CHEVROLET	KODIAK	CATERPILLAR 3116 DIESEL	1997-2000
CHEVROLET	KODIAK	CATERPILLAR 3126 DIESEL	2000-2008
 38510 TENSOR			
INTERNATIONAL/NAVISTAR	3800	INTERNATIONAL/NAVISTAR T444 DIESEL	1998-2002
INTERNATIONAL/NAVISTAR	4600	INTERNATIONAL/NAVISTAR T444 DIESEL	1995-1995
INTERNATIONAL/NAVISTAR	4700	INTERNATIONAL/NAVISTAR T444 DIESEL	1995-2002
INTERNATIONAL/NAVISTAR	4800	INTERNATIONAL/NAVISTAR T444 DIESEL	1995-1997
INTERNATIONAL/NAVISTAR	4900	INTERNATIONAL/NAVISTAR T444 DIESEL	1995-1997
INTERNATIONAL/NAVISTAR	CE	INTERNATIONAL/NAVISTAR T444 DIESEL	2003-2004
INTERNATIONAL/NAVISTAR	CONVENTIONAL IC	INTERNATIONAL/NAVISTAR T444 DIESEL	2003-2003
INTERNATIONAL/NAVISTAR	CONVENTIONAL IC	INTERNATIONAL/NAVISTAR T444 DIESEL	2002-2002
 38511 TENSOR			
FREIGHTLINER	CENTURY CLASS	CATERPILLAR C15 DIESEL	2005-2006
FREIGHTLINER	CLASSIC XL	CATERPILLAR C15 DIESEL	2005-2005
FREIGHTLINER	COLUMBIA	CATERPILLAR C15 DIESEL	2005-2005
FREIGHTLINER	CORONADO	CATERPILLAR C15 DIESEL	2005-2006
FREIGHTLINER	FLD	CATERPILLAR C15 DIESEL	2005-2008
INTERNATIONAL/NAVISTAR	4300	INTERNATIONAL/NAVISTAR DT466	2002-2004
INTERNATIONAL/NAVISTAR	4400	INTERNATIONAL/NAVISTAR 530 DIESEL	2002-2005
INTERNATIONAL/NAVISTAR	4400	INTERNATIONAL/NAVISTAR DT466	2002-2005
INTERNATIONAL/NAVISTAR	4700	INTERNATIONAL/NAVISTAR DT408 DIESEL	1995-1997
INTERNATIONAL/NAVISTAR	4700	INTERNATIONAL/NAVISTAR DT466	1995-1999
INTERNATIONAL/NAVISTAR	4800	INTERNATIONAL/NAVISTAR DT408 DIESEL	1995-1997
INTERNATIONAL/NAVISTAR	4800	INTERNATIONAL/NAVISTAR DT466	1995-2003
INTERNATIONAL/NAVISTAR	4900	INTERNATIONAL/NAVISTAR DT408 DIESEL	1995-1997
INTERNATIONAL/NAVISTAR	4900	INTERNATIONAL/NAVISTAR DT466	1995-1999
INTERNATIONAL/NAVISTAR	5600I	CATERPILLAR C15 DIESEL	2004-2004
INTERNATIONAL/NAVISTAR	5900I	CATERPILLAR C15 DIESEL	2004-2006
INTERNATIONAL/NAVISTAR	7100	INTERNATIONAL/NAVISTAR DT466	1995-1995
INTERNATIONAL/NAVISTAR	7300	INTERNATIONAL/NAVISTAR DT466	2002-2003
INTERNATIONAL/NAVISTAR	7400	INTERNATIONAL/NAVISTAR 530 DIESEL	2002-2003
INTERNATIONAL/NAVISTAR	7400	INTERNATIONAL/NAVISTAR DT466	2002-2003
INTERNATIONAL/NAVISTAR	7400	INTERNATIONAL/NAVISTAR DT530 DIESEL	2004-2005
INTERNATIONAL/NAVISTAR	7500	INTERNATIONAL/NAVISTAR 530 DIESEL	2002-2003
INTERNATIONAL/NAVISTAR	7500	INTERNATIONAL/NAVISTAR DT466	2002-2002
INTERNATIONAL/NAVISTAR	7500	INTERNATIONAL/NAVISTAR DT530 DIESEL	2004-2005
INTERNATIONAL/NAVISTAR	8100	INTERNATIONAL/NAVISTAR 530 DIESEL	1995-1998

MARCA	MODELO	MOTOR	AÑOS
INTERNATIONAL/NAVISTAR	8100	INTERNATIONAL/NAVISTAR 530 DIESEL	1995-1995
INTERNATIONAL/NAVISTAR	8100	INTERNATIONAL/NAVISTAR DT466	1995-2000
INTERNATIONAL/NAVISTAR	8200	DETROIT DIESEL 6 CIL, 11.1 L DIESEL	1995-1995
INTERNATIONAL/NAVISTAR	8200	DETROIT DIESEL 6 CIL, 12.7 L DIESEL	1995-1995
INTERNATIONAL/NAVISTAR	8200	INTERNATIONAL/NAVISTAR 530 DIESEL	1996-1997
INTERNATIONAL/NAVISTAR	8200	INTERNATIONAL/NAVISTAR DT466	1997-1997
INTERNATIONAL/NAVISTAR	8500	INTERNATIONAL/NAVISTAR 530 DIESEL	2002-2005
INTERNATIONAL/NAVISTAR	9400I	CATERPILLAR C15 DIESEL	2004-2007
INTERNATIONAL/NAVISTAR	9900I	CATERPILLAR C15 DIESEL	2004-2008
INTERNATIONAL/NAVISTAR	9900IX	CATERPILLAR C15 DIESEL	2004-2007
INTERNATIONAL/NAVISTAR	PAYSTAR 5600I	CATERPILLAR C15 DIESEL	2008-2008
KENWORTH	C500	CATERPILLAR C15 DIESEL	2007-2008
KENWORTH	T2000	CATERPILLAR C15 DIESEL	2004-2010
KENWORTH	T300	CATERPILLAR 3126 DIESEL	1996-1997
KENWORTH	T300	CATERPILLAR 3126 DIESEL	1998-2003
KENWORTH	T600	CATERPILLAR C15 DIESEL	2007-2008
KENWORTH	T800	CATERPILLAR C15 DIESEL	2005-2007
KENWORTH	W900	CATERPILLAR C15 DIESEL	2004-2007
STERLING	ACTERRA	CATERPILLAR 3126 DIESEL	2001-2004
STERLING	ACTERRA	CATERPILLAR C7 DIESEL	2004-2004
STERLING	L-LINE	CATERPILLAR 3126 DIESEL	2000-2004
STERLING	L-LINE	CATERPILLAR 3126 DIESEL	2001-2001
STERLING	L-LINE	CATERPILLAR C7 DIESEL	2004-2004
 38512 TENSOR			
INTERNATIONAL/NAVISTAR	4700	INTERNATIONAL/NAVISTAR 530 DIESEL	1999-2002
INTERNATIONAL/NAVISTAR	4700	INTERNATIONAL/NAVISTAR DT466	2000-2002
INTERNATIONAL/NAVISTAR	4800	INTERNATIONAL/NAVISTAR 530 DIESEL	2002-2002
INTERNATIONAL/NAVISTAR	4900	INTERNATIONAL/NAVISTAR 530 DIESEL	1995-2002
INTERNATIONAL/NAVISTAR	4900	INTERNATIONAL/NAVISTAR DT466	2000-2002
INTERNATIONAL/NAVISTAR	4900	INTERNATIONAL/NAVISTAR DT530E	2001-2001
INTERNATIONAL/NAVISTAR	5500I	INTERNATIONAL/NAVISTAR DT466	2001-2002
INTERNATIONAL/NAVISTAR	5600I	INTERNATIONAL/NAVISTAR DT466	2001-2002
INTERNATIONAL/NAVISTAR	8100	INTERNATIONAL/NAVISTAR 530 DIESEL	1999-2003
 38513 TENSOR			
STERLING	L-LINE	CUMMINS ISC DIESEL	2000-2003
 38514 TENSOR			
FREIGHTLINER	FLD	CATERPILLAR C10 DIESEL	1997-1997
FREIGHTLINER	FLD	CATERPILLAR C12 DIESEL	1996-1997



MASTER SERVICIO PESADO 2014

TENSORES Y POLEAS

MARCA	MODELO	MOTOR	AÑOS
INTERNATIONAL/NAVISTAR	3300	INTERNATIONAL/NAVISTAR DT466	2004-2004
INTERNATIONAL/NAVISTAR	3800	INTERNATIONAL/NAVISTAR DT466	1998-1999
INTERNATIONAL/NAVISTAR	3800	INTERNATIONAL/NAVISTAR DT466	2000-2001
INTERNATIONAL/NAVISTAR	4300	INTERNATIONAL/NAVISTAR DT466	2002-2004
INTERNATIONAL/NAVISTAR	4400	INTERNATIONAL/NAVISTAR 530 DIESEL	2002-2005
INTERNATIONAL/NAVISTAR	4400	INTERNATIONAL/NAVISTAR DT466	2002-2005
INTERNATIONAL/NAVISTAR	4700	INTERNATIONAL/NAVISTAR 530 DIESEL	1999-2002
INTERNATIONAL/NAVISTAR	4700	INTERNATIONAL/NAVISTAR DT408 DIESEL	1995-1997
INTERNATIONAL/NAVISTAR	4700	INTERNATIONAL/NAVISTAR DT466	1995-2002
INTERNATIONAL/NAVISTAR	4800	INTERNATIONAL/NAVISTAR 530 DIESEL	2002-2002
INTERNATIONAL/NAVISTAR	4800	INTERNATIONAL/NAVISTAR DT408 DIESEL	1995-1997
INTERNATIONAL/NAVISTAR	4800	INTERNATIONAL/NAVISTAR DT466	1995-2003
INTERNATIONAL/NAVISTAR	4900	INTERNATIONAL/NAVISTAR 530 DIESEL	1995-2002
INTERNATIONAL/NAVISTAR	4900	INTERNATIONAL/NAVISTAR DT408 DIESEL	1995-1997
INTERNATIONAL/NAVISTAR	4900	INTERNATIONAL/NAVISTAR DT466	1995-2002
INTERNATIONAL/NAVISTAR	4900	INTERNATIONAL/NAVISTAR DT530E	2001-2001
INTERNATIONAL/NAVISTAR	5500I	INTERNATIONAL/NAVISTAR DT466	2001-2002
INTERNATIONAL/NAVISTAR	5600I	INTERNATIONAL/NAVISTAR DT466	2001-2002
INTERNATIONAL/NAVISTAR	7100	INTERNATIONAL/NAVISTAR DT466	1995-1995
INTERNATIONAL/NAVISTAR	7300	INTERNATIONAL/NAVISTAR DT466	2002-2003
INTERNATIONAL/NAVISTAR	7400	INTERNATIONAL/NAVISTAR 530 DIESEL	2002-2003
INTERNATIONAL/NAVISTAR	7400	INTERNATIONAL/NAVISTAR DT466	2002-2003
INTERNATIONAL/NAVISTAR	7400	INTERNATIONAL/NAVISTAR DT530 DIESEL	2004-2005
INTERNATIONAL/NAVISTAR	7500	INTERNATIONAL/NAVISTAR 530 DIESEL	2002-2003
INTERNATIONAL/NAVISTAR	7500	INTERNATIONAL/NAVISTAR DT466	2002-2002
INTERNATIONAL/NAVISTAR	7500	INTERNATIONAL/NAVISTAR DT530 DIESEL	2004-2005
INTERNATIONAL/NAVISTAR	8100	CATERPILLAR 3176 DIESEL	1995-1997
INTERNATIONAL/NAVISTAR	8100	INTERNATIONAL/NAVISTAR 530 DIESEL	1996-2003
INTERNATIONAL/NAVISTAR	8100	INTERNATIONAL/NAVISTAR DT466	1995-2000
INTERNATIONAL/NAVISTAR	8200	INTERNATIONAL/NAVISTAR 530 DIESEL	1996-1997
INTERNATIONAL/NAVISTAR	8200	INTERNATIONAL/NAVISTAR DT466	1997-1997
INTERNATIONAL/NAVISTAR	8500	INTERNATIONAL/NAVISTAR 530 DIESEL	2002-2005
INTERNATIONAL/NAVISTAR	CE	INTERNATIONAL/NAVISTAR DT466	2003-2004
INTERNATIONAL/NAVISTAR	CONVENTIONAL IC	INTERNATIONAL/NAVISTAR DT466	2002-2003
INTERNATIONAL/NAVISTAR	FE	INTERNATIONAL/NAVISTAR DT466	2002-2004
INTERNATIONAL/NAVISTAR	RE	INTERNATIONAL/NAVISTAR 530 DIESEL	1998-2004



38516
TENSOR

DINA	102 F	CUMMINS ISB	2008-2009
DINA	104-R	CUMMINS ISB	2008-2009
DINA	104-SF	CUMMINS ISB	2008-2009
DINA	94 F	CUMMINS ISB	2008-2008
FORD	F-650 SUPER DUTY	CUMMINS ISB DIESEL	2002-2004
FORD	F-650 SUPER DUTY	CUMMINS ISB DIESEL	2000-2000

MARCA	MODELO	MOTOR	AÑOS
FORD	F-650 SUPER DUTY	CUMMINS ISB DIESEL	2001-2001
FORD	F-750 SUPER DUTY	CUMMINS ISB DIESEL	2002-2004
FORD	F-750 SUPER DUTY	CUMMINS ISB DIESEL	2000-2000
FORD	F-750 SUPER DUTY	CUMMINS ISB DIESEL	2001-2001
FREIGHTLINER	BUSINESS CLASS M2	CUMMINS ISC DIESEL	2004-2004
FREIGHTLINER	BUSINESS CLASS M2	CUMMINS ISC DIESEL	2006-2006
KENWORTH	T300	CUMMINS ISC DIESEL	2005-2005
KENWORTH	T300	CUMMINS ISC DIESEL	2006-2006
KENWORTH	T300	CUMMINS ISC DIESEL	2006-2008
KENWORTH	T300	CUMMINS ISC DIESEL	1998-2004
KENWORTH	T800	CUMMINS ISL	2005-2006
KENWORTH	T800	CUMMINS ISL DIESEL	2001-2009
KENWORTH	W900	CUMMINS ISC DIESEL	2003-2004
STERLING	ACTERRA	CUMMINS ISC DIESEL	2005-2008
STERLING	L-LINE	CUMMINS ISB DIESEL	2000-2000



38517
TENSOR

FORD	F-600	CUMMINS B Series 5.9 L DIESEL	1992-1994
FORD	F-650 SUPER DUTY	CUMMINS ISB DIESEL	2005-2007
FORD	F-750 SUPER DUTY	CUMMINS ISB DIESEL	2005-2007
FORD	F-800	CUMMINS ISB DIESEL	1998-1998



38519
TENSOR

INTERNATIONAL/NAVISTAR	9100	DETROIT DIESEL SERIE 60	1998-1998
INTERNATIONAL/NAVISTAR	9200	DETROIT DIESEL 6 CIL, 11.1 L DIESEL	1995-1997
INTERNATIONAL/NAVISTAR	9200	DETROIT DIESEL 6 CIL, 12.7 L DIESEL	1995-1997
INTERNATIONAL/NAVISTAR	9200	DETROIT DIESEL SERIE 60	1998-1998
INTERNATIONAL/NAVISTAR	9400	DETROIT DIESEL 6 CIL, 11.1 L DIESEL	1995-1996
INTERNATIONAL/NAVISTAR	9400	DETROIT DIESEL 6 CIL, 12.7 L DIESEL	1995-1996
INTERNATIONAL/NAVISTAR	9400	DETROIT DIESEL SERIE 60	1997-1999
INTERNATIONAL/NAVISTAR	9400I	DETROIT DIESEL 6 CIL, 12.7 L DIESEL	2001-2001
INTERNATIONAL/NAVISTAR	9400I	DETROIT DIESEL SERIE 60	2000-2000
INTERNATIONAL/NAVISTAR	9600	DETROIT DIESEL 6 CIL, 11.1 L DIESEL	1996-1996
INTERNATIONAL/NAVISTAR	9600	DETROIT DIESEL 6 CIL, 12.7 L DIESEL	1995-1995
INTERNATIONAL/NAVISTAR	9700	DETROIT DIESEL 6 CIL, 11.1 L DIESEL	1996-1996
INTERNATIONAL/NAVISTAR	9700	DETROIT DIESEL 6 CIL, 12.7 L DIESEL	1996-1996
INTERNATIONAL/NAVISTAR	9800	DETROIT DIESEL SERIE 60	1997-1997
INTERNATIONAL/NAVISTAR	9900	DETROIT DIESEL SERIE 60	1999-1999
INTERNATIONAL/NAVISTAR	9900I	DETROIT DIESEL 6 CIL, 12.7 L DIESEL	2001-2001
INTERNATIONAL/NAVISTAR	9900I	DETROIT DIESEL SERIE 60	2000-2000
INTERNATIONAL/NAVISTAR	9900IX	DETROIT DIESEL 6 CIL, 12.7 L DIESEL	2001-2001
INTERNATIONAL/NAVISTAR	9900IX	DETROIT DIESEL SERIE 60	2000-2000

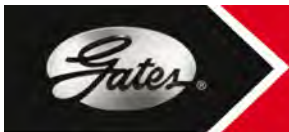

MASTER SERVICIO PESADO 2014

TENSORES Y POLEAS

MARCA	MODELO	MOTOR	AÑOS
 38521 TENSOR			
FREIGHTLINER	ARGOSY	CUMMINS ISM DIESEL	2000-2000
FREIGHTLINER	CENTURY CLASS CLASSIC	CUMMINS ISM DIESEL	1998-2001
FREIGHTLINER	CLASSIC XL	CUMMINS ISM DIESEL	2001-2001
FREIGHTLINER	CLASSIC XL	CUMMINS ISM DIESEL	2002-2003
FREIGHTLINER	COLUMBIA	CUMMINS ISM DIESEL	2001-2003
FREIGHTLINER	FL112	CUMMINS ISM DIESEL	2000-2003
FREIGHTLINER	FLD	CUMMINS ISM DIESEL	2000-2000
FREIGHTLINER	FLD	CUMMINS ISM DIESEL	2001-2001
FREIGHTLINER	FLD	CUMMINS ISM DIESEL	2002-2003
FREIGHTLINER	FLD120	CUMMINS ISM DIESEL	2001-2002
INTERNATIONAL/NAVISTAR	5500	CUMMINS ISM DIESEL	2005-2005
INTERNATIONAL/NAVISTAR	5500I	CUMMINS ISM DIESEL	2002-2004
INTERNATIONAL/NAVISTAR	5600	CUMMINS ISM DIESEL	2005-2005
INTERNATIONAL/NAVISTAR	5600I	CUMMINS ISM DIESEL	2002-2004
INTERNATIONAL/NAVISTAR	5900I	CUMMINS ISM DIESEL	2001-2004
INTERNATIONAL/NAVISTAR	7600	CUMMINS ISM DIESEL	2003-2004
INTERNATIONAL/NAVISTAR	8600	CUMMINS ISM DIESEL	2003-2004
INTERNATIONAL/NAVISTAR	9000	CUMMINS ISM DIESEL	2004-2004
INTERNATIONAL/NAVISTAR	9200	CUMMINS ISM DIESEL	2005-2005
INTERNATIONAL/NAVISTAR	9200I	CUMMINS ISM DIESEL	2003-2004
INTERNATIONAL/NAVISTAR	9400I	CUMMINS ISM DIESEL	2004-2005
INTERNATIONAL/NAVISTAR	PROSTAR SERIES	CUMMINS ISX DIESEL	2007-2008
KENWORTH	T600	CUMMINS ISM DIESEL	2004-2004
KENWORTH	T600	CUMMINS ISM DIESEL	2001-2002
KENWORTH	T800	CUMMINS ISM DIESEL	1999-2004
KENWORTH	W900	CUMMINS ISM DIESEL	2002-2004
 38523 TENSOR			
MACK	CH SERIES	MACK 6 CIL, 12.0 L DIESEL	2001-2002
MACK	CH SERIES	MACK AC DIESEL	2003-2006
MACK	CHN SERIES	MACK AC DIESEL	2006-2007
MACK	CL SERIES	MACK 6 CIL, 12.0 L DIESEL	2001-2001
MACK	CS SERIES	MACK AC DIESEL	2003-2003
MACK	CV SERIES	MACK 6 CIL, 12.0 L DIESEL	2001-2002
MACK	CV SERIES	MACK AI DIESEL	2003-2003
MACK	CV SERIES	MACK AI DIESEL	2005-2007
MACK	CV SERIES	MACK AMI DIESEL	2003-2003
MACK	CV SERIES	MACK AMI DIESEL	2004-2006
MACK	CX SERIES	MACK 6 CIL, 12.0 L DIESEL	2001-2002

MARCA	MODELO	MOTOR	AÑOS
MACK	CXN SERIES	MACK AC DIESEL	2006-2007
MACK	CXP SERIES	MACK MP7 DIESEL	2006-2006
MACK	DM SERIES	MACK 6 CIL, 12.0 L DIESEL	2001-2001
MACK	LE SERIES	MACK AI DIESEL	2003-2005
MACK	MR SERIES	MACK 6 CIL, 12.0 L DIESEL	2001-2002
MACK	RD SERIES	MACK 6 CIL, 12.0 L DIESEL	2001-2002
 38524 TENSOR			
FREIGHTLINER	ARGOSY	CATERPILLAR C10 DIESEL	2000-2003
FREIGHTLINER	ARGOSY	CATERPILLAR C12 DIESEL	2000-2004
FREIGHTLINER	CENTURY CLASS	CATERPILLAR C10 DIESEL	2001-2003
FREIGHTLINER	CENTURY CLASS	CATERPILLAR C12 DIESEL	2001-2004
FREIGHTLINER	COLUMBIA	CATERPILLAR C10 DIESEL	2001-2003
FREIGHTLINER	COLUMBIA	CATERPILLAR C12 DIESEL	2003-2004
FREIGHTLINER	FL112	CATERPILLAR C10 DIESEL	2001-2004
FREIGHTLINER	FL112	CATERPILLAR C12 DIESEL	2001-2004
FREIGHTLINER	FLD	CATERPILLAR C10 DIESEL	2001-2004
FREIGHTLINER	FLD	CATERPILLAR C12 DIESEL	2001-2004
FREIGHTLINER	FLD120	CATERPILLAR C10 DIESEL	2001-2004
FREIGHTLINER	FLD120	CATERPILLAR C12 DIESEL	2001-2004
STERLING	A-LINE	CATERPILLAR C10 DIESEL	2002-2004
STERLING	A-LINE	CATERPILLAR C12 DIESEL	2002-2004
 38529 TENSOR			
INTERNATIONAL/NAVISTAR	9100	DETROIT DIESEL SERIE 60	1999-1999
INTERNATIONAL/NAVISTAR	9100I	DETROIT DIESEL 6 CIL, 12.7 L DIESEL	2001-2003
INTERNATIONAL/NAVISTAR	9100I	DETROIT DIESEL SERIE 60	2000-2000
INTERNATIONAL/NAVISTAR	9200	DETROIT DIESEL SERIE 60	1999-1999
INTERNATIONAL/NAVISTAR	9200I	DETROIT DIESEL 6 CIL, 12.7 L DIESEL	2001-2001
INTERNATIONAL/NAVISTAR	9200I	DETROIT DIESEL SERIE 60	2000-2000
 38531 TENSOR			
VOLVO	7550	7550	2001-2006
VOLVO	7550 FL	B12	2005-2008
VOLVO	9700	B12	2002-2006
VOLVO	WG SERIES	VOLVO VE D12 DIESEL	1999-1999
VOLVO	WG SERIES	VOLVO VE D12 DIESEL	1998-2001
 38532 TENSOR			

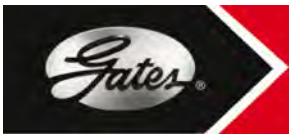

MASTER SERVICIO PESADO 2014

TENSORES Y POLEAS

MARCA	MODELO	MOTOR	AÑOS
FREIGHTLINER	ARGOSY	CUMMINS ISX DIESEL	1999-2003
FREIGHTLINER	CENTURY CLASS	CUMMINS ISX DIESEL	2000-2001
FREIGHTLINER	COLUMBIA	CUMMINS ISX DIESEL	2001-2001
FREIGHTLINER	FLD	CUMMINS ISX DIESEL	1999-2003
INTERNATIONAL/NAVISTAR	9100I	CUMMINS ISX DIESEL	2001-2003
INTERNATIONAL/NAVISTAR	9200I	CUMMINS SIGNATURE 600 DIESEL	2000-2002
INTERNATIONAL/NAVISTAR	9400I	CUMMINS ISX DIESEL	2000-2002
INTERNATIONAL/NAVISTAR	9900I	CUMMINS ISX DIESEL	2000-2002
INTERNATIONAL/NAVISTAR	9900IX	CUMMINS ISX DIESEL	2000-2003
KENWORTH	T2000	CUMMINS ISX DIESEL	1999-2003
KENWORTH	T600	CUMMINS SIGNATURE 600 DIESEL	2003-2003
KENWORTH	T800	CUMMINS ISX DIESEL	1999-2003
KENWORTH	W900	CUMMINS ISX DIESEL	1999-2003
KENWORTH	W900	CUMMINS SIGNATURE 600 DIESEL	2000-2002
MACK	CH SERIES	CUMMINS SIGNATURE 600 DIESEL	2001-2003
MACK	CL SERIES	CUMMINS SIGNATURE 600 DIESEL	2001-2003
STERLING	L-LINE	CUMMINS ISX DIESEL	2001-2001
STERLING	L-LINE	CUMMINS SIGNATURE 600 DIESEL	2001-2001
VOLVO	VNL	CUMMINS ISX DIESEL	2000-2003
VOLVO	VNL	CUMMINS SIGNATURE 600 DIESEL	2003-2003
 38534 TENSOR			
FREIGHTLINER	CENTURY CLASS	CATERPILLAR C10 DIESEL	1999-2000
FREIGHTLINER	CENTURY CLASS	CATERPILLAR C12 DIESEL	1999-2000
FREIGHTLINER	FL112	CATERPILLAR C10 DIESEL	1999-2000
FREIGHTLINER	FL112	CATERPILLAR C12 DIESEL	1999-2000
FREIGHTLINER	FLD	CATERPILLAR C10 DIESEL	1998-2000
FREIGHTLINER	FLD	CATERPILLAR C12 DIESEL	1998-2000
INTERNATIONAL/NAVISTAR	5500I	CATERPILLAR C10 DIESEL	2003-2004
INTERNATIONAL/NAVISTAR	5500I	CATERPILLAR C12 DIESEL	2003-2004
INTERNATIONAL/NAVISTAR	5600I	CATERPILLAR C10 DIESEL	2003-2004
INTERNATIONAL/NAVISTAR	5600I	CATERPILLAR C12 DIESEL	2003-2004
INTERNATIONAL/NAVISTAR	5900I	CATERPILLAR C10 DIESEL	2003-2003
INTERNATIONAL/NAVISTAR	5900I	CATERPILLAR C12 DIESEL	2003-2004
INTERNATIONAL/NAVISTAR	7600	CATERPILLAR C10 DIESEL	2004-2004
INTERNATIONAL/NAVISTAR	7600	CATERPILLAR C12 DIESEL	2004-2004
 38535 TENSOR			
FREIGHTLINER	ARGOSY	CUMMINS ISX DIESEL	1999-2003
FREIGHTLINER	CENTURY CLASS	CUMMINS ISX DIESEL	2001-2001
FREIGHTLINER	CENTURY CLASS	CUMMINS ISX DIESEL	2000-2000
FREIGHTLINER	COLUMBIA	CUMMINS ISX DIESEL	2001-2001

MARCA	MODELO	MOTOR	AÑOS
FREIGHTLINER	FLD	CUMMINS ISX DIESEL	1999-2003
INTERNATIONAL/NAVISTAR	9100I	CUMMINS ISX DIESEL	2001-2003
INTERNATIONAL/NAVISTAR	9200I	CUMMINS SIGNATURE 600 DIESEL	2000-2002
INTERNATIONAL/NAVISTAR	9400I	CUMMINS ISX DIESEL	2000-2002
INTERNATIONAL/NAVISTAR	9900I	CUMMINS ISX DIESEL	2000-2002
INTERNATIONAL/NAVISTAR	9900IX	CUMMINS ISX DIESEL	2000-2003
KENWORTH	T2000	CUMMINS ISX DIESEL	1999-2003
KENWORTH	T600	CUMMINS SIGNATURE 600 DIESEL	2003-2003
KENWORTH	T800	CUMMINS ISX DIESEL	1999-2003
KENWORTH	W900	CUMMINS ISX DIESEL	1999-2003
KENWORTH	W900	CUMMINS SIGNATURE 600 DIESEL	2000-2002
MACK	CH SERIES	CUMMINS SIGNATURE 600 DIESEL	2001-2003
MACK	CL SERIES	CUMMINS SIGNATURE 600 DIESEL	2001-2003
STERLING	L-LINE	CUMMINS ISX DIESEL	2001-2001
STERLING	L-LINE	CUMMINS SIGNATURE 600 DIESEL	2001-2001
VOLVO	VNL	CUMMINS ISX DIESEL	2000-2003
VOLVO	VNL	CUMMINS SIGNATURE 600 DIESEL	2003-2003
 38536 TENSOR			
VOLVO	VNL	CUMMINS N14 DIESEL	2000-2002
VOLVO	VNM	CUMMINS N14 DIESEL	2002-2003
 38539 TENSOR			
VOLVO	VHD	CUMMINS ISM DIESEL	2002-2003
VOLVO	VNL	CUMMINS ISM DIESEL	2002-2003
 38540 TENSOR			
FREIGHTLINER	CENTURY CLASS	MERCEDES-BENZ MBE 4000 DIESEL	2004-2004
FREIGHTLINER	COLUMBIA	MERCEDES-BENZ MBE 4000 DIESEL	2003-2004
FREIGHTLINER	FL112	MERCEDES-BENZ MBE 4000 DIESEL	2003-2004
 38541 TENSOR			
FREIGHTLINER	CENTURY CLASS	MERCEDES-BENZ MBE 4000 DIESEL	2004-2004
FREIGHTLINER	COLUMBIA	MERCEDES-BENZ MBE 4000 DIESEL	2003-2004
FREIGHTLINER	FL112	MERCEDES-BENZ MBE 4000 DIESEL	2003-2004
 38545 TENSOR			



MASTER SERVICIO PESADO 2014

TENSORES Y POLEAS

MARCA	MODELO	MOTOR	AÑOS	MARCA	MODELO	MOTOR	AÑOS
VOLVO	VNL	CUMMINS ISM DIESEL	2001-2001	CHEVROLET	C7500	CATERPILLAR 3126 DIESEL	2003-2003
				CHEVROLET	C8500	CATERPILLAR 3126 DIESEL	2003-2003
VOLVO	VHD	VOLVO VE D12 DIESEL	2001-2002				
VOLVO	VNL	VOLVO VE D12 DIESEL	1998-2003	FREIGHTLINER	BUSINESS CLASS M2	MERCEDES BENZ MBE 900 DIESEL	2008-2008
				FREIGHTLINER	BUSINESS CLASS M2	MERCEDES-BENZ MBE 900 DIESEL	2006-2007
CHEVROLET	C6500	ISUZU 6HK1-TC DIESEL	2003-2006	FREIGHTLINER	BUSINESS CLASS M2	MERCEDES-BENZ MBE 900 DIESEL	2004-2005
CHEVROLET	C7500	ISUZU 6HK1-TC DIESEL	2003-2006	STERLING	ACTERRA	MERCEDES-BENZ MBE 900 DIESEL	2001-2004
CHEVROLET	C8500	ISUZU 6HK1-TC DIESEL	2003-2006	STERLING	ACTERRA	MERCEDES-BENZ MBE 900 DIESEL	2001-2007
							
FORD	F-650 SUPER DUTY	CATERPILLAR C7 DIESEL	2004-2006	FREIGHTLINER	CENTURY CLASS	CATERPILLAR C15 DIESEL	2005-2006
FORD	F-750 SUPER DUTY	CATERPILLAR C7 DIESEL	2004-2006	FREIGHTLINER	CLASSIC XL	CATERPILLAR C15 DIESEL	2005-2005
FREIGHTLINER	BUSINESS CLASS M2	CATERPILLAR 3126 DIESEL	2002-2007	FREIGHTLINER	COLUMBIA	CATERPILLAR C15 DIESEL	2005-2005
FREIGHTLINER	BUSINESS CLASS M2	CATERPILLAR C7 DIESEL	2004-2007	FREIGHTLINER	COLUMBIA	CATERPILLAR C15 DIESEL	2006-2007
FREIGHTLINER	BUSINESS CLASS M2	CATERPILLAR C9 DIESEL	2004-2007	FREIGHTLINER	CORONADO	CATERPILLAR C15 DIESEL	2005-2006
STERLING	L-LINE	CATERPILLAR C7 DIESEL	2005-2005	FREIGHTLINER	FLD	CATERPILLAR C15 DIESEL	2005-2008
				INTERNATIONAL/NAVISTAR	5600I	CATERPILLAR C15 DIESEL	2004-2004
FORD	F-650 SUPER DUTY	FORD V8, 6.0 L DIESEL	2003-2006	INTERNATIONAL/NAVISTAR	5900I	CATERPILLAR C15 DIESEL	2004-2006
FORD	F-750 SUPER DUTY	FORD V8, 6.0 L DIESEL	2003-2006	INTERNATIONAL/NAVISTAR	9400I	CATERPILLAR C15 DIESEL	2004-2007
INTERNATIONAL/NAVISTAR	4100	INTERNATIONAL/NAVISTAR VT365 DIESEL	2006-2007	INTERNATIONAL/NAVISTAR	9900I	CATERPILLAR C15 DIESEL	2004-2008
INTERNATIONAL/NAVISTAR	4200	INTERNATIONAL/NAVISTAR VT365 DIESEL	2002-2007	INTERNATIONAL/NAVISTAR	9900IX	CATERPILLAR C15 DIESEL	2004-2007
INTERNATIONAL/NAVISTAR	4300	INTERNATIONAL/NAVISTAR VT365 DIESEL	2003-2003	INTERNATIONAL/NAVISTAR	PAYSTAR 5600i	CATERPILLAR C15 DIESEL	2008-2008
INTERNATIONAL/NAVISTAR	4400	INTERNATIONAL/NAVISTAR VT365 DIESEL	2003-2003	KENWORTH	C500	CATERPILLAR C15 DIESEL	2007-2008
INTERNATIONAL/NAVISTAR	BE	INTERNATIONAL/NAVISTAR MAXXFORCE 7 DIESEL	2008-2013	KENWORTH	T2000	CATERPILLAR C15 DIESEL	2004-2010
INTERNATIONAL/NAVISTAR	BE	INTERNATIONAL/NAVISTAR VT365 DIESEL	2007-2008	KENWORTH	T600	CATERPILLAR C15 DIESEL	2007-2008
INTERNATIONAL/NAVISTAR	CE	INTERNATIONAL/NAVISTAR VT365 DIESEL	2007-2007	KENWORTH	T800	CATERPILLAR C15 DIESEL	2005-2005
INTERNATIONAL/NAVISTAR	CE	INTERNATIONAL/NAVISTAR VT365 DIESEL	2005-2005	KENWORTH	T800	CATERPILLAR C15 DIESEL	2006-2007
INTERNATIONAL/NAVISTAR	CE	INTERNATIONAL/NAVISTAR VT365 DIESEL	2007-2007	KENWORTH	W900	CATERPILLAR C15 DIESEL	2004-2007
INTERNATIONAL/NAVISTAR	DURASTAR 4300	INTERNATIONAL/NAVISTAR MAXXFORCE 7 DIESEL	2010-2012				
INTERNATIONAL/NAVISTAR	DURASTAR 4300	INTERNATIONAL/NAVISTAR MAXXFORCE 7 DIESEL	2008-2008	CHEVROLET	T6500	ISUZU 6HK1-TC DIESEL	2005-2008
INTERNATIONAL/NAVISTAR	DURASTAR 4300	INTERNATIONAL/NAVISTAR MAXXFORCE DT DIESEL	2010-2010	CHEVROLET	T7500	ISUZU 6HK1-TC DIESEL	2005-2008
				CHEVROLET	T8500	ISUZU 6HK1-TC DIESEL	2005-2008
CHEVROLET	C6500	CATERPILLAR 3126 DIESEL	2003-2003				
				VOLVO	VHD	VOLVO VE 12 DIESEL	2002-2002
				VOLVO	VHD	VOLVO VE D12 DIESEL	2003-2009
				VOLVO	VNL	VOLVO D16 DIESEL	2008-2013

MARCA	MODELO	MOTOR	AÑOS
VOLVO	VNL	VOLVO VE D12 DIESEL	2004-2008
VOLVO	VNL	VOLVO VE D16 DIESEL	2006-2009
VOLVO	VNM	VOLVO D16 DIESEL	2008-2013
VOLVO	VNM	VOLVO VE D12 DIESEL	2006-2008
VOLVO	VNM	VOLVO VE D16 DIESEL	2006-2009
VOLVO	VT SERIES	VOLVO VE D16 DIESEL	2006-2009



38584
TENSOR

VOLKSWAGEN	15-190 WORKER	CUMMINS INTERACT 5.9 DIESEL (EURO III)	2005-2011
VOLKSWAGEN	17-210 VOLKSBUS	MWM de 6.2 DIESEL ELECTRONICO	2005-2011
VOLKSWAGEN	17-250 WORKER	CUMMINS INTERACT 5.9 DIESEL (EURO III)	2005-2011
VOLKSWAGEN	24-250 WORKER	CUMMINS INTERACT 5.9 DIESEL (EURO III)	2005-2011
VOLKSWAGEN	8-150 VOLKSBUS	CUMMINS INTERACT 3.9 DIESEL (EURO III)	2008-2011
VOLKSWAGEN	8-150 VOLKSBUS	CUMMINS Interact 3.9 DIESEL (EURO III)	2005-2007
VOLKSWAGEN	8-150 WORKER	CUMMINS Interact 3.9 DIESEL (EURO III)	2005-2011



38585
TENSOR

VOLVO	VHD	VOLVO VE D12 DIESEL	2005-2009
VOLVO	VNL	VOLVO D16 DIESEL	2008-2013
VOLVO	VNL	VOLVO VE D12 DIESEL	2004-2008
VOLVO	VNL	VOLVO VE D16 DIESEL	2006-2009
VOLVO	VNM	VOLVO D16 DIESEL	2008-2013
VOLVO	VNM	VOLVO VE D12 DIESEL	2006-2008
VOLVO	VNM	VOLVO VE D16 DIESEL	2006-2009
VOLVO	VT SERIES	VOLVO VE D16 DIESEL	2006-2009



38586
TENSOR

CHEVROLET	C6500	CATERPILLAR C7 DIESEL	2004-2007
CHEVROLET	C7500	CATERPILLAR C7 DIESEL	2004-2007
CHEVROLET	C8500	CATERPILLAR C7 DIESEL	2004-2007
KENWORTH	T300	CATERPILLAR C7 DIESEL	2004-2007
STERLING	L-LINE	CATERPILLAR C7 DIESEL	2007-2007



38587
TENSOR

INTERNATIONAL/NAVISTAR	5500I	CUMMINS ISX DIESEL	2003-2007
INTERNATIONAL/NAVISTAR	5600I	CUMMINS ISX DIESEL	2005-2007
INTERNATIONAL/NAVISTAR	5900I	CUMMINS ISX DIESEL	2003-2007
INTERNATIONAL/NAVISTAR	9200I	CUMMINS ISX DIESEL	2003-2013
INTERNATIONAL/NAVISTAR	9400I	CUMMINS ISX DIESEL	2003-2007

MARCA	MODELO	MOTOR	AÑOS
INTERNATIONAL/NAVISTAR	9900I	CUMMINS ISX DIESEL	2003-2008
INTERNATIONAL/NAVISTAR	9900IX	CUMMINS ISX DIESEL	2003-2007
INTERNATIONAL/NAVISTAR	PAYSTAR 5500I	CUMMINS ISX DIESEL	2008-2008
INTERNATIONAL/NAVISTAR	PAYSTAR 5900I	CUMMINS ISX DIESEL	2008-2008
KENWORTH	T2000	CUMMINS ISX DIESEL	2004-2006
KENWORTH	T600	CUMMINS ISX DIESEL	2002-2010
KENWORTH	T660	CATERPILLAR C15 DIESEL	2007-2013
KENWORTH	T660	CUMMINS ISX DIESEL	2007-2014
KENWORTH	T800	CUMMINS ISX DIESEL	2004-2014
KENWORTH	W900	CUMMINS ISX DIESEL	2010-2013
KENWORTH	W900	CUMMINS ISX DIESEL	2003-2007
MACK	CL SERIES	CUMMINS ISX DIESEL	2004-2007
VOLVO	VNL	CUMMINS ISX DIESEL	2003-2013
VOLVO	VNL	CUMMINS SIGNATURE 600 DIESEL	2003-2003
VOLVO	VNM	CUMMINS ISX DIESEL	2006-2013



38589
TENSOR

MACK	CH SERIES	MACK AC DIESEL	2003-2006
MACK	CHN SERIES	MACK AC DIESEL	2006-2007
MACK	CT SERIES	MACK AI DIESEL	2006-2006
MACK	CT SERIES	MACK AI DIESEL	2007-2007
MACK	CT SERIES	MACK AMI DIESEL	2006-2006
MACK	CV SERIES	MACK AI DIESEL	2006-2007
MACK	CV SERIES	MACK AMI DIESEL	2004-2005
MACK	CX SERIES	MACK AC DIESEL	2003-2006
MACK	CXN SERIES	MACK AC DIESEL	2006-2007
MACK	CXP SERIES	MACK MP7 DIESEL	2006-2006
MACK	MR SERIES	MACK AMI DIESEL	2003-2005



38590
TENSOR

FREIGHTLINER	BUSINESS CLASS M2	CATERPILLAR C13 DIESEL	2004-2007
FREIGHTLINER	CENTURY CLASS	CATERPILLAR C11 DIESEL	2006-2006
FREIGHTLINER	CENTURY CLASS	CATERPILLAR C13 DIESEL	2006-2006
FREIGHTLINER	COLUMBIA	CATERPILLAR C11 DIESEL	2004-2007
FREIGHTLINER	COLUMBIA	CATERPILLAR C13 DIESEL	2004-2009
FREIGHTLINER	FLD	CATERPILLAR C11 DIESEL	2005-2007
FREIGHTLINER	FLD	CATERPILLAR C13 DIESEL	2005-2007
FREIGHTLINER	FLD120	CATERPILLAR C11 DIESEL	2005-2005
FREIGHTLINER	FLD120	CATERPILLAR C13 DIESEL	2005-2005
INTERNATIONAL/NAVISTAR	5500I	CATERPILLAR C13 DIESEL	2005-2007
INTERNATIONAL/NAVISTAR	5600I	CATERPILLAR C13 DIESEL	2005-2005
INTERNATIONAL/NAVISTAR	7600	CATERPILLAR C11 DIESEL	2004-2007



MASTER SERVICIO PESADO 2014

TENSORES Y POLEAS

MARCA	MODELO	MOTOR	AÑOS	MARCA	MODELO	MOTOR	AÑOS								
INTERNATIONAL/NAVISTAR	7600	CATERPILLAR C13 DIESEL	2004-2008	MACK	MR SERIES	MACK AMI DIESEL	2006-2006								
INTERNATIONAL/NAVISTAR	7700	CATERPILLAR C11 DIESEL	2005-2006	MACK	MR SERIES	MACK AMI DIESEL	2003-2005								
INTERNATIONAL/NAVISTAR	7700	CATERPILLAR C13 DIESEL	2005-2006	MACK	MR SERIES	MACK AMI DIESEL	2007-2007								
INTERNATIONAL/NAVISTAR	8600	CATERPILLAR C11 DIESEL	2004-2007	 <div style="background-color: red; color: white; padding: 5px; text-align: center; font-weight: bold;">38607 TENSOR</div>											
INTERNATIONAL/NAVISTAR	8600	CATERPILLAR C13 DIESEL	2004-2007												
INTERNATIONAL/NAVISTAR	9200I	CATERPILLAR C13 DIESEL	2004-2008												
INTERNATIONAL/NAVISTAR	9400I	CATERPILLAR C13 DIESEL	2004-2007												
KENWORTH	T800	CATERPILLAR C11 DIESEL	2003-2009												
KENWORTH	T800	CATERPILLAR C13 DIESEL	2004-2007												
KENWORTH	W900	CATERPILLAR C13 DIESEL	2005-2007	MACK	CTP SERIES	MACK MP7 DIESEL	2007-2007								
KENWORTH	W900	CATERPILLAR C11 DIESEL	2005-2007	MACK	CXP SERIES	MACK MP7 DIESEL	2007-2007								
KENWORTH	W900	CATERPILLAR C13 DIESEL	2004-2007	VOLVO	9700 FL	B12	2005-2011								
STERLING	ACTERRA	CATERPILLAR C13 DIESEL	2006-2006	VOLVO	VHD	CUMMINS ISM DIESEL	2002-2003								
STERLING	ACTERRA	CATERPILLAR C13 DIESEL	2006-2006	VOLVO	VNL	CUMMINS ISM DIESEL	2002-2003								
STERLING	A-LINE	CATERPILLAR C11 DIESEL	2004-2006	 <div style="background-color: red; color: white; padding: 5px; text-align: center; font-weight: bold;">38609 TENSOR</div>											
STERLING	A-LINE	CATERPILLAR C13 DIESEL	2005-2006												
STERLING	A-LINE	CATERPILLAR C15 DIESEL	2005-2006												
STERLING	L-LINE	CATERPILLAR C11 DIESEL	2004-2007												
STERLING	L-LINE	CATERPILLAR C13 DIESEL	2004-2007												
STERLING	L-LINE	CATERPILLAR C15 DIESEL	2005-2007												
STERLING	L-LINE	CATERPILLAR C9 DIESEL	2005-2007	FREIGHTLINER	COLUMBIA	CATERPILLAR C15 DIESEL	2008-2009								
 <div style="background-color: red; color: white; padding: 5px; text-align: center; font-weight: bold;">38597 TENSOR</div>				FREIGHTLINER	FLD	CATERPILLAR C15 DIESEL	2009-2010								
				KENWORTH	T660	CATERPILLAR C15 DIESEL	2007-2013								
				KENWORTH	T800	CATERPILLAR C15 DIESEL	2008-2013								
				 <div style="background-color: red; color: white; padding: 5px; text-align: center; font-weight: bold;">38610 TENSOR</div>				INTERNATIONAL/NAVISTAR	9200I	CUMMINS ISX DIESEL	2003-2013				
								INTERNATIONAL/NAVISTAR	9400I	CUMMINS ISX DIESEL	2004-2007				
								INTERNATIONAL/NAVISTAR	9900I	CUMMINS ISX DIESEL	2003-2008				
INTERNATIONAL/NAVISTAR	PROSTAR SERIES	CUMMINS ISX DIESEL	2009-2012												
INTERNATIONAL/NAVISTAR	PROSTAR SERIES	CUMMINS ISX DIESEL	2007-2008												
KENWORTH	T600	CUMMINS ISX DIESEL	2002-2010												
FREIGHTLINER	BUSINESS CLASS M2	MERCEDES-BENZ MBE 4000 DIESEL	2004-2007	KENWORTH	T660	CUMMINS ISX DIESEL	2007-2014								
FREIGHTLINER	CASCADIA	MERCEDES BENZ MBE 4000 Diesel	2008-2012	KENWORTH	T800	CUMMINS ISX DIESEL	2004-2014								
FREIGHTLINER	CENTURY CLASS	MERCEDES BENZ MBE 4000 Diesel	2009-2010	KENWORTH	W900	CUMMINS ISX DIESEL	2010-2013								
FREIGHTLINER	CENTURY CLASS	MERCEDES-BENZ MBE 4000 DIESEL	2005-2005	VOLVO	VNL	CUMMINS ISX DIESEL	2004-2013								
FREIGHTLINER	CLASSIC	MERCEDES BENZ MBE 4000 Diesel	2009-2010	VOLVO	VNM	CUMMINS ISX DIESEL	2006-2013								
FREIGHTLINER	CLASSIC XL	MERCEDES BENZ MBE 4000 Diesel	2009-2010	 <div style="background-color: red; color: white; padding: 5px; text-align: center; font-weight: bold;">38611 TENSOR</div>											
FREIGHTLINER	COLUMBIA	MERCEDES BENZ MBE 4000 Diesel	2008-2010												
FREIGHTLINER	COLUMBIA	MERCEDES-BENZ MBE 4000 DIESEL	2005-2007												
FREIGHTLINER	FLD	MERCEDES BENZ MBE 4000 Diesel	2009-2010												
STERLING	A-LINE	MERCEDES-BENZ MBE 4000 DIESEL	2004-2008												
STERLING	L-LINE	MERCEDES-BENZ MBE 4000 DIESEL	2003-2007												
 <div style="background-color: red; color: white; padding: 5px; text-align: center; font-weight: bold;">38598 TENSOR</div>				MACK	CX SERIES	MACK AC DIESEL	2003-2005								
				FREIGHTLINER	BUSINESS CLASS M2	MERCEDES-BENZ MBE 900 DIESEL	2006-2007	 <div style="background-color: red; color: white; padding: 5px; text-align: center; font-weight: bold;">38617 TENSOR</div>							
				 <div style="background-color: red; color: white; padding: 5px; text-align: center; font-weight: bold;">38599 TENSOR</div>								MACK	LE SERIES	MACK AI DIESEL	2005-2006
												MACK	LE SERIES	MACK AI DIESEL	2004-2004
												MACK	MR SERIES	MACK AI DIESEL	2005-2006
												MACK	LE SERIES	MACK AI DIESEL	2004-2004
MACK	MR SERIES	MACK AI DIESEL	2005-2006												
MACK	LE SERIES	MACK AI DIESEL	2005-2006												

MARCA	MODELO	MOTOR	AÑOS	MARCA	MODELO	MOTOR	AÑOS
<p>38620 TENSOR</p>				<p>38629 TENSOR</p>			
INTERNATIONAL/NAVISTAR	4300	INTERNATIONAL/NAVISTAR DT466	2005-2008	INTERNATIONAL/NAVISTAR	DURASTAR 4300	INTERNATIONAL/NAVISTAR MAXXFORCE 7 DIESEL	2010-2010
INTERNATIONAL/NAVISTAR	4400	INTERNATIONAL/NAVISTAR DT466	2006-2008	<p>38631 TENSOR</p>			
INTERNATIONAL/NAVISTAR	4400	INTERNATIONAL/NAVISTAR DT570 DIESEL	2004-2008				
INTERNATIONAL/NAVISTAR	7300	INTERNATIONAL/NAVISTAR DT466	2005-2006	<p>38632 TENSOR</p>			
INTERNATIONAL/NAVISTAR	7400	INTERNATIONAL/NAVISTAR 570 DIESEL	2006-2006				
INTERNATIONAL/NAVISTAR	7400	INTERNATIONAL/NAVISTAR DT466	2005-2007	FORD	F-650 SUPER DUTY	CUMMINS ISB-07 DIESEL	2008-2009
INTERNATIONAL/NAVISTAR	7400	INTERNATIONAL/NAVISTAR DT570 DIESEL	2005-2007	FORD	F-750 SUPER DUTY	CUMMINS ISB-07 DIESEL	2008-2009
INTERNATIONAL/NAVISTAR	7500	INTERNATIONAL/NAVISTAR HT570 DIESEL	2005-2007	KENWORTH	T300	PACCAR PX-6 DIESEL	2007-2010
INTERNATIONAL/NAVISTAR	8500	INTERNATIONAL/NAVISTAR DT570 DIESEL	2006-2006	KENWORTH	T370	PACCAR PX-6	2009-2011
INTERNATIONAL/NAVISTAR	8500	INTERNATIONAL/NAVISTAR HT570 DIESEL	2005-2007	<p>38633 TENSOR</p>			
INTERNATIONAL/NAVISTAR	8600	INTERNATIONAL/NAVISTAR HT570 DIESEL	2005-2005				
INTERNATIONAL/NAVISTAR	CE	INTERNATIONAL/NAVISTAR DT466	2005-2007	MACK	CHU SERIES	MACK MP8 DIESEL	2008-2010
INTERNATIONAL/NAVISTAR	CE	INTERNATIONAL/NAVISTAR DT466	2008-2008	MACK	GRANITE	MACK MP8 DIESEL	2011-2013
INTERNATIONAL/NAVISTAR	CE	INTERNATIONAL/NAVISTAR MAXXFORCE DT DIESEL	2008-2008	MACK	GU SERIES	MACK MP8 DIESEL	2008-2010
INTERNATIONAL/NAVISTAR	CXT	INTERNATIONAL/NAVISTAR DT466	2005-2006	<p>38634 TENSOR</p>			
INTERNATIONAL/NAVISTAR	DURASTAR 4300	INTERNATIONAL/NAVISTAR MAXXFORCE DT DIESEL	2012-2012				
INTERNATIONAL/NAVISTAR	FE	INTERNATIONAL/NAVISTAR DT466	2005-2005	MACK	CXU SERIES	MACK MP8 DIESEL	2008-2010
INTERNATIONAL/NAVISTAR	FE	INTERNATIONAL/NAVISTAR MAXXFORCE DT DIESEL	2009-2009	VOLVO	VNL	VOLVO D13 DIESEL	2008-2014
INTERNATIONAL/NAVISTAR	RE	INTERNATIONAL/NAVISTAR DT466	1998-2006	VOLVO	VNM	VOLVO D13 DIESEL	2008-2014
INTERNATIONAL/NAVISTAR	RE	INTERNATIONAL/NAVISTAR DT466	2007-2008	<p>38635 TENSOR</p>			
<p>38622 TENSOR</p>							
INTERNATIONAL/NAVISTAR	55001	CUMMINS ISM DIESEL	2005-2006	<p>38634 TENSOR</p>			
INTERNATIONAL/NAVISTAR	56001	CUMMINS ISM DIESEL	2005-2007				
INTERNATIONAL/NAVISTAR	59001	CUMMINS ISM DIESEL	2005-2006	INTERNATIONAL/NAVISTAR	CE	INTERNATIONAL/NAVISTAR MAXXFORCE DT DIESEL	2009-2012
INTERNATIONAL/NAVISTAR	7400	CUMMINS ISM DIESEL	2005-2005	INTERNATIONAL/NAVISTAR	DURASTAR 4300	INTERNATIONAL/NAVISTAR MAXXFORCE DT DIESEL	2008-2013
INTERNATIONAL/NAVISTAR	7600	CUMMINS ISM DIESEL	2005-2007	INTERNATIONAL/NAVISTAR	DURASTAR 4400	INTERNATIONAL/NAVISTAR MAXXFORCE DT DIESEL	2008-2013
INTERNATIONAL/NAVISTAR	7700	CUMMINS ISM DIESEL	2005-2006	INTERNATIONAL/NAVISTAR	FE	INTERNATIONAL/NAVISTAR MAXXFORCE DT DIESEL	2010-2012
INTERNATIONAL/NAVISTAR	8600	CUMMINS ISM DIESEL	2005-2007	INTERNATIONAL/NAVISTAR	RE	INTERNATIONAL/NAVISTAR MAXXFORCE DT DIESEL	2008-2012
INTERNATIONAL/NAVISTAR	92001	CUMMINS ISM DIESEL	2005-2007	INTERNATIONAL/NAVISTAR	RE	INTERNATIONAL/NAVISTAR MAXXFORCE DT DIESEL	2009-2012
INTERNATIONAL/NAVISTAR	94001	CUMMINS ISM DIESEL	2006-2007	INTERNATIONAL/NAVISTAR	WORKSTAR 7300	INTERNATIONAL/NAVISTAR MAXXFORCE DT DIESEL	2008-2009
INTERNATIONAL/NAVISTAR	TRANSTAR 8600	CUMMINS ISM DIESEL	2008-2008	INTERNATIONAL/NAVISTAR	WORKSTAR 7400	INTERNATIONAL/NAVISTAR MAXXFORCE 9 DIESEL	2008-2012
INTERNATIONAL/NAVISTAR	WORKSTAR 7600	CUMMINS ISM DIESEL	2008-2010	<p>38635 TENSOR</p>			
KENWORTH	T800	CUMMINS ISM DIESEL	2005-2014				
KENWORTH	W900	CUMMINS ISM DIESEL	2005-2006	FREIGHTLINER	BUSINESS CLASS M2	CATERPILLAR C13 DIESEL	2009-2010
<p>38627 TENSOR</p>				KENWORTH	T660	CATERPILLAR C13 DIESEL	2009-2013
				KENWORTH	T800	CATERPILLAR C13 DIESEL	2008-2014
FREIGHTLINER	BUSINESS CLASS M2	CUMMINS ISC DIESEL	2007-2011	KENWORTH	W900	CATERPILLAR C13 DIESEL	2008-2010

TRANSPORTE



Mangueras de Silicón Milimétricas para Camiones y Autobuses VOLVO



SIHVLVGATES890



SIHVLVGATES839



SIHVLVGATES997



SIHVLVGATES997



SIHVLVGATES304



SIHVLVGATES306



OE	DIMENSIONES	NÚMERO GATES
21461809	Turbo 89 mm DI x 76 mm DI x 140 mm / 3 anillos	SIHVLVGATES809
21461839	Codo doble reducido 58 mm DI x 48 mm DI x 155 mm	SIHVLVGATES839
21766000	Turbo 101 mm DI x 108 mm / 3 anillos y terminales metalicas	SIHVLVGATES6000
21765997	Turbo 101 mm DI x 70 mm / 2 anillos y terminales metalicas	SIHVLVGATES997
9519304	Codo 75° 57 mm DI x 60 mm DI x 185 mm x 175 mm	SIHVLVGATES304
9519306	Codo 105° 57 mm DI x 60 mm DI x 120 mm x 120 mm	SIHVLVGATES306



¡DONDE QUIERA QUE VAYAS ESTAMOS CONTIGO!



MASTER SERVICIO PESADO 2014

TENSORES Y POLEAS

MARCA	MODELO	MOTOR	AÑOS
			
FREIGHTLINER	COLUMBIA	CATERPILLAR C15 DIESEL	2008-2009
FREIGHTLINER	FLD	CATERPILLAR C15 DIESEL	2009-2010
KENWORTH	T800	CATERPILLAR C15 DIESEL	2008-2013

38636
TENSOR

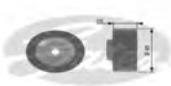
MARCA	MODELO	MOTOR	AÑOS
			
FORD	TRANSIT	4 CIL, 2.2 L TDI	2008-2013
PEUGEOT	MANAGER	4 CIL, 2.2 L DIESEL	2013-2014

T36124
POLEA

			
FREIGHTLINER	BUSINESS CLASS M2	CATERPILLAR C13 DIESEL	2009-2010
KENWORTH	T660	CATERPILLAR C13 DIESEL	2009-2013
KENWORTH	T800	CATERPILLAR C13 DIESEL	2008-2014

38646
TENSOR

			
VOLKSWAGEN	CRAFTER	5 CIL, 2.0 L TDI	2013-2014
VOLKSWAGEN	TRANSPORTER	4 CIL, 2.0 L TDI	2010-2014

T36248
POLEA

			
MACK	CHU SERIES	MACK MP8 DIESEL	2008-2010
MACK	CXU SERIES	MACK MP8 DIESEL	2008-2010
MACK	GRANITE	MACK MP8 DIESEL	2011-2013
MACK	GU SERIES	MACK MP8 DIESEL	2008-2010
VOLVO	VNL	VOLVO D13 DIESEL	2008-2014
VOLVO	VNM	VOLVO D13 DIESEL	2008-2014

38671
TENSOR

			
FIAT	DUCATO	4 CIL, 3.0 L DIESEL	2008-2013
PEUGEOT	MANAGER	4 CIL, 3.0 L DIESEL	2008-2013

T36402
POLEA

			
FORD	F-450 SUPER DUTY	V8, 6.4 L DIESEL	2008-2010
FORD	F-450 SUPER DUTY	V8, 6.4 L DIESEL	2009-2010
FORD	F-550 SUPER DUTY	V8, 6.4 L DIESEL	2008-2010

39051
TENSOR

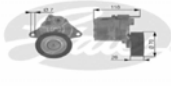
			
MERCEDES BENZ	SPRINTER	4 CIL, 2.2 L CDI	2006-2013
MERCEDES BENZ	SPRINTER	5 CIL, 2.7 L CDI	2003-2006
MERCEDES BENZ	VITO	4 CIL, 2.2 L CDI	2009-2013

T38415
TENSOR

			
FORD	F-450 SUPER DUTY	V8, 6.4 L DIESEL	2008-2010
FORD	F-450 SUPER DUTY	V8, 6.4 L DIESEL	2009-2010
FORD	F-550 SUPER DUTY	V8, 6.4 L DIESEL	2008-2010

39052
TENSOR

			
VOLKSWAGEN	CRAFTER	5 CIL, 2.0 L TDI	2013-2014

T38427
TENSOR

			
FORD	F-450 SUPER DUTY	V8, 6.7 L DIESEL	2011-2013
FORD	F-450 SUPER DUTY	V8, 6.7 L DIESEL	2011-2012
FORD	F-550 SUPER DUTY	V8, 6.7 L DIESEL	2011-2013

39153
TENSOR

			
MERCEDES BENZ	BOXER	MB 904	2005-2010
MERCEDES BENZ	TORINO	MB 906	2005-2010

T38460
TENSOR

			
FORD	TRANSIT	4 CIL, 2.2 L TDI	2008-2013
PEUGEOT	MANAGER	4 CIL, 2.2 L DIESEL	2013-2014

T39107
TENSOR

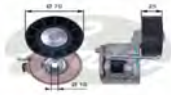
			
FIAT	DUCATO	4 CIL, 3.0 L DIESEL	2008-2013
PEUGEOT	MANAGER	4 CIL, 3.0 L DIESEL	2008-2013

T39137
TENSOR

MARCA	MODELO	MOTOR	AÑOS	MARCA	MODELO	MOTOR	AÑOS
		T41005 TENSOR		VOLKSWAGEN	EUROVAN	4 CIL. 1.9 L DIESEL	2005-2010
FORD	RANGER	4 CIL. 2.3 L	1995-2001			T43163 TENSOR	
FORD	RANGER	4 CIL. 2.5 L	1998-2001	FIAT	DUCATO	4 CIL. 2.3 L DIESEL	2008-2013
		T41044 TENSOR				TMV-22001 TENSOR	
HYUNDAI	H100	4 CIL. 2.4 L	2003-2005	VOLKSWAGEN	PANEL	4 CIL. 1.8 L	1998-2001
		T41053 TENSOR				TMV-22002 TENSOR	
HYUNDAI	H100	4 CIL. 2.4 L	2003-2005	VOLKSWAGEN	PANEL	4 CIL. 1.8 L	1998-2001
		T41229 TENSOR				TMV-23001 TENSOR	
VOLKSWAGEN	EUROVAN	4 CIL. 1.9 L DIESEL	2005-2010	VOLKSWAGEN	VW VAN	4 CIL. 1.6 L	2003-2006
		T41240 TENSOR				TPG-14004 TENSOR	
RENAULT	TRAFIC	4 CIL. 1.9 L DIESEL	2008-2009	CHEVROLET	TORNADO	4 CIL. 1.8 L	2003-2013
		T42129 POLEA				TPG-22001 TENSOR	
HYUNDAI	H100	4 CIL. 2.5 L DIESEL	2009-2010	VOLKSWAGEN	EUROVAN	5 CIL. 2.5 L	2001-2005
HYUNDAI	H100	4 CIL. 2.5 L DIESEL	2011-2014			TPG-23001 TENSOR	
HYUNDAI	H100 VANWAGON	4 CIL. 2.5 L DIESEL	2009-2010	VOLKSWAGEN	SAVEIRO	4 CIL. 1.6 L	2010-2013
HYUNDAI	H100 VANWAGON	4 CIL. 2.5 L DIESEL	2009-2013	VOLKSWAGEN	VW VAN	4 CIL. 1.6 L	2003-2005
		T42130 TENSOR					
HYUNDAI	H100	4 CIL. 2.5 L DIESEL	2006-2014				
		T43064 TENSOR					
RENAULT	KANGOO	4 CIL. 1.6 L	2005-2013				
RENAULT	KANGOO EXPRESS	4 CIL. 1.6 L	2005-2008				
		T43091 TENSOR					



MASTER SERVICIO PESADO 2014

OEM

OEM	GATES	OEM	GATES	OEM	GATES	OEM	GATES
33469	T724	20582557	K120640	981335	K100437	3579000C1	K080806
038109244J	T43091	88GB460P640	K120640	1848715C1	K081331	3972383	K080806
33469	T42129	20878554	K120610	53041138AA	K081264	3664150C1	K080794
038109243M	T41229	1881079C1	K101091	D8410003082875	K081124	1842463C1	K080774
A6112000570 / A6462000270	T38415	1847725C1	K101015	53041139AA	K081102	3944837	K080745
33469	T36124	1847748C1	K100983	1832193C2	K081065	1842455C1	K080723
038109119P	T333	130883420	K100953	1889037C1	K081047	3959841	K080720
030109119AB	T1548	D8410006102405	K100946	3565413C3	K081047	1839964C1	K080702
33469	T1096	1847727C1	K100894	D11089803	K081023	D8410006081735	K080683
F046002	SIH250363C	1879845C1	K100877	3565413C3	K080991	20582552	K080630
F506	SIH250363C	1847708C1	K100870	1832194C2	K080962	88GB457P630	K080630
F5061792400125	SIH250363C	1847707C1	K100860	7C3Z8620M	K080956	88GB457P588	K080590
F046006	SIH250124C90	1847716C1	K100822	D8410001082430	K080956	20451458	K080565
F5061792280100	SIH175363C	1847751C1	K100818	123415055	K080952	20464710	K080550
D8410006122665	K121049	20582563	K100764	D11084930	K080952	SZ91045249	K080550
130882000	K120985	1847732C1	K100745	D11084936	K080939	127116013	K080505
D8410006122490	K120980	1847677C1	K100731	D8410001082370	K080934	51968200243	K080505
D8410006122490	K120979	1847736C1	K100726	3972265	K080878	20430368	K080385
D8410006122310	K120911	1847678C1	K100720	3972377	K080868	978238	K080375
D8410006122215	K120872	1888631C1	K100702	7C3Z8620E	K080865	117201PDOA	K070961
3817452C1	K120870	20491756	K100582	124587002	K080855	11720EA200	K070873
D11084213	K120864	20440066	K100579	1888570C1	K080855	11720VZ00A	K070840
D8410006122180	K120858	20882779	K100578	3289974	K080855	8980316670	K070425
20481362	K120842	20440066	K100572	1842466C1	K080845	8980031870	K070404
20886339	K120786	36811820	K100510	4080825	K080825	BC3Z8620A	K061058
88GB460P787	K120786	20430382	K100437	3605646C1	K080816	7C3Z8620D	K061005



MASTER SERVICIO PESADO 2014

OEM

OEM	GATES	OEM	GATES	OEM	GATES	OEM	GATES
33469	K061000	4004824	K060539	254104F150	CH-119412	21454379	38671
33469	K060997	3579001C1	K060516	254114F100	CH-119411	2873203	38646
5C3Z8620AA	K060997	D840003061315	K060516	11950VN20A	9490L	2790253	38636
2L3Z8620DB	K060990	D8410003061280	K060505	SZ91045251	9463	2756558	38635
A0149971792 / A0149970492	K060895	ME241670	K060480	11920VN20A	9365L	1873217C1	38634
A0149970692 / A0089977092	K060888	06A145933D	K060441	SZ91045251	8468 GS	1873217C2	38634
130884175	K060858	03L903137D	K060425	06A260849E	6DPK1200	20860873	38633
D8410006062175	K060858	9C3Z8620A	K060393	9931895	6469MC	20487079	38632
1L5Z8620AC	K060828	33469	K040420	D11022461	6420 GS	4937433	38631
33469	K060806	33469	K040415	4089910RX	45054HD	1832711C2	38629
5C3Z8620BA	K060806	33469	K040370	4089908NX	45051HD	3973819	38627
D8410006061870	K060736	BC3Z8620B	DK081403	23535018	44066HD	4920105	38622
1L5Z8620BC	K060730	BC3Z8620C	DK081254	2807374	44062HD	1841760C1	38620
131165840	K060723	7H0121051G	CH-220112	3145155	44062HD	3104149	38610
1847509C1	K060696	7H0122101	CH-220111	2807374	44052HD	3682683	38610
D8410006061750	K060690	21503VM00A	CH-180302	5086959AA	43526HD	2362301	38609
36811812	K060685	21501VMC0A	CH-180301	1842664C92	43325HD	21177895	38590
33469	K060660	21503VW200	CH-180172	1842665C92	43325HD	2117895	38590
6C1Q6C301CC	K060660	21501VZ20A	CH-180171	1842665C93	43325HD	2871292	38587
20457273	K060637	21501VZ00A	CH-180151	68003402AA	42291HD	3682946	38587
D11085527	K060637	21503VZ00A	CH-180142	4089647	42146HD	21422767	38585
D8410003061620	K060637	215052S711	CH-180102	2807374	42062HD	8149855	38585
D8410006061620	K060637	21501VN20A	CH-180101	BC3Z6B209A	39153	20491753	38581
03L903137H	K060612	1657375070	CH-150112	7C3Z6B209B	39052	21155561	38581
D11085689	K060575	1657375060	CH-150102	7C3Z6B209A	39051	2002279	38569
D8410003061460	K060575	1657275270	CH-150101	20762060	38671	1833688C2	38556



MASTER SERVICIO PESADO 2014

OEM

OEM	GATES	OEM	GATES	OEM	GATES	OEM	GATES
21257889	38547	20747516	36285	55056954AA	23965	8149333	22710
3681240	38535	3970945	36283	55056955AA	23956	20486071	22709
3680194	38532	2850277	36282	3614940C1	23795	3187641	22709
3936213 / 3976831	38516	2078118	36269	3610318C2	23794	1L5Z8286AD	22654
3976831	38516	3C3Z8678BB	36234	3614939C1	23793	2L5Z8260CA	21947
21788938	38511	2790251	36227	20943431	23564	3558668C2	21891
2178938	38511	3104139	36225	11MF4422M	23563	485796C2	21891
3102888	38505	3682229	36223	20824501	23563	516062090	21891
11955EA20B	38378	119277S000	36222	5C3Z8260BA	23275	525481001	21891
5086958AA	38285	3682946	36165	5C3Z8260AC	23273	3610324C1	21302
1844538C1	38257	1841930C1	36164	5C3Z8286CA	23266	3605661C2	21135
1L5Z6B209AA	38155	21177895	36164	524072001	23229	3605681C1	21135
A0002020019	38099	2117895	36164	521574001	23015	485794C1	21135
33469	38023	33469	36157	521603000	22950	485796C2	21135
33469	38022	3680194	36095	55056945AE	22893	F046002	21135
1832712C1	38006	3936213	36093	52028872AG	22892	516062079	20987
33469	38006	923681240	36092	3532994C4	22775	516836013	20987
33469	38001	1979641	36091	3545713C3	22775	3532993C2	20731
3C3Z8678BB	36354	21788938	36091	3532993C2	22774	55056711AC	18774
1632710C1	36351	2178938	36091	3546116C3	22774	55056712AB	18710
1832710C1	36351	3102888	36091	3532994C4	22742		
1979642	36341	4004933	36091	8086454	22717		
68000833AD	36315	1979642	36041	11MF4449M	22714		
3400884	36308	F04006	28212	20943428	22714		
20457029	36286	525973000	26045	21000108	22714		
20953521	36286	516062092	24047	20447437	22710		



NOTAS

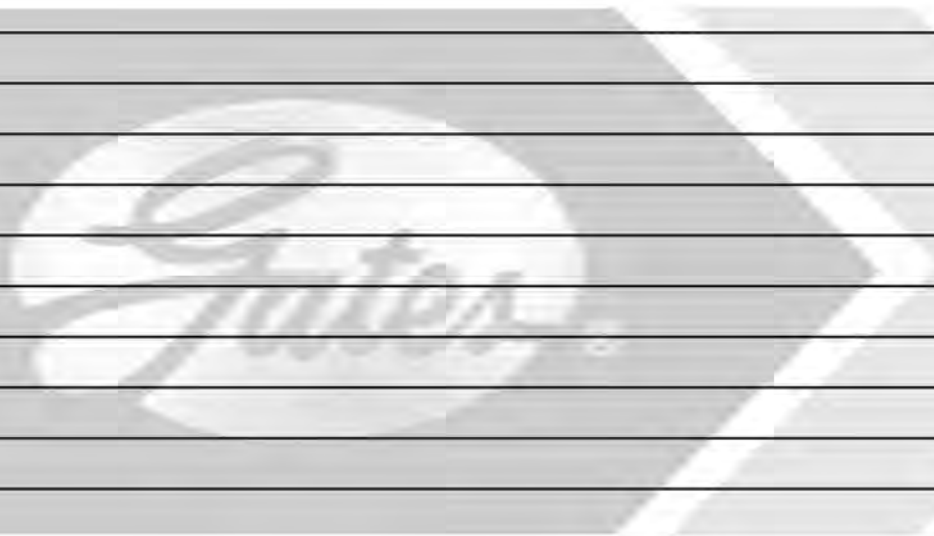



GATES DE MÉXICO

www.Gates.com.mx



/GatesdeMexico



**You
Tube**

youtube/GatesdeMéxico



@GatesdeMéxico

**MARCA DE PESO
EN SERVICIO PESADO**

Contamos con la gama más amplia de productos en servicio pesado



POWERING PROGRESS™

CARGA / PASAJE 1990 - 2014

Gates de México, S.A. de C.V.
Av. Vasco de Quiroga 3200
Centro Ciudad Santa Fe,
C.P. 01210, México D.F.
Tel: 52-55-2000-2700 - 01 (800) 874 2837
Fax: 52-55 8850-2801